



SPACE OVIEL™

Operation, Maintenance
and Service Manual
Complete with Illustrated Parts Lists

GAME SERIAL NUMBER LOCATION

Your game's serial number is stamped on a label on the outside of the game. The same number is also on the chassis of the video display, power supply, Regulator/Audio II PCB, and the Game PCB. Please mention this number when calling your distributor for service.

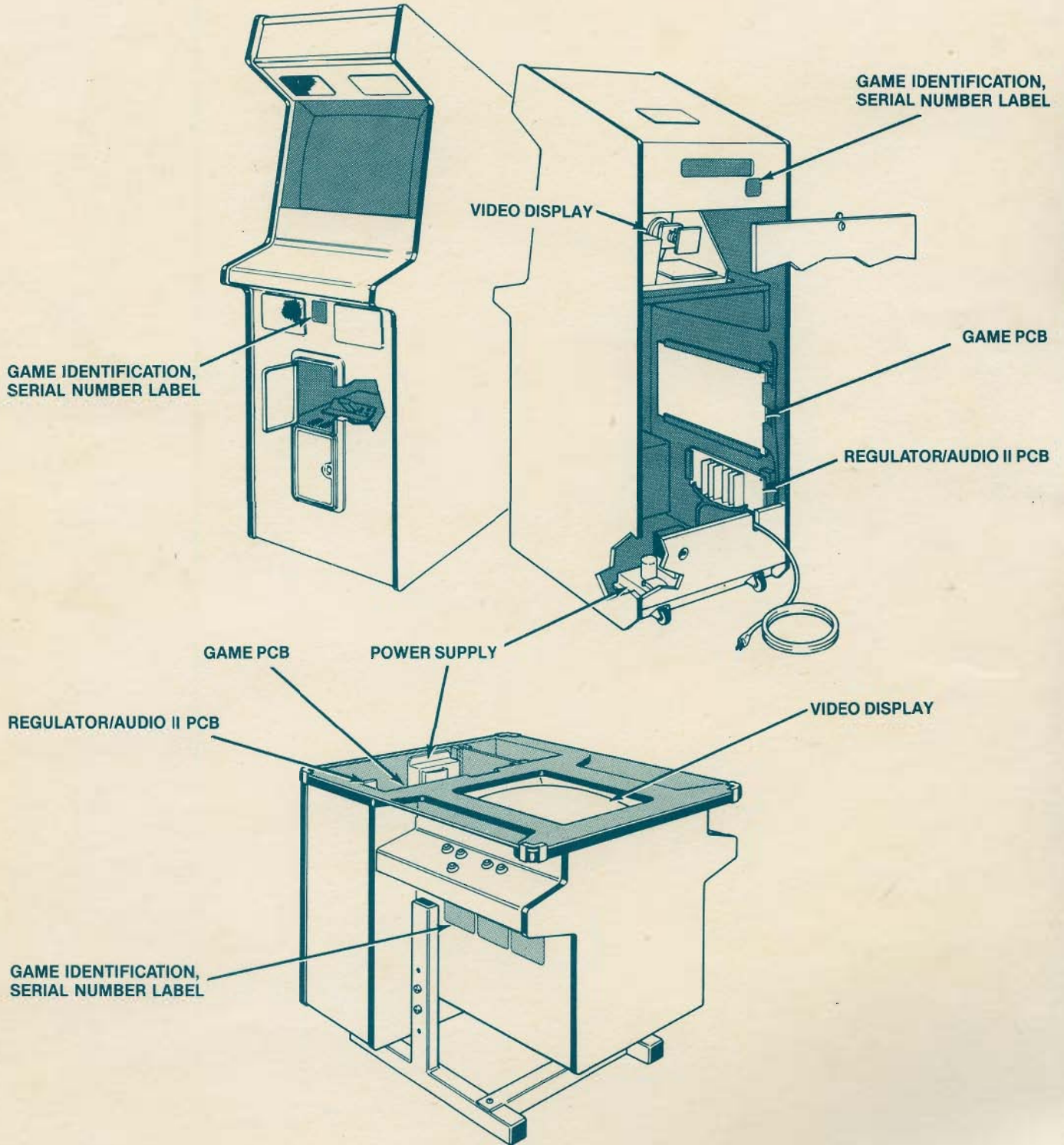

SPACE DUEL™

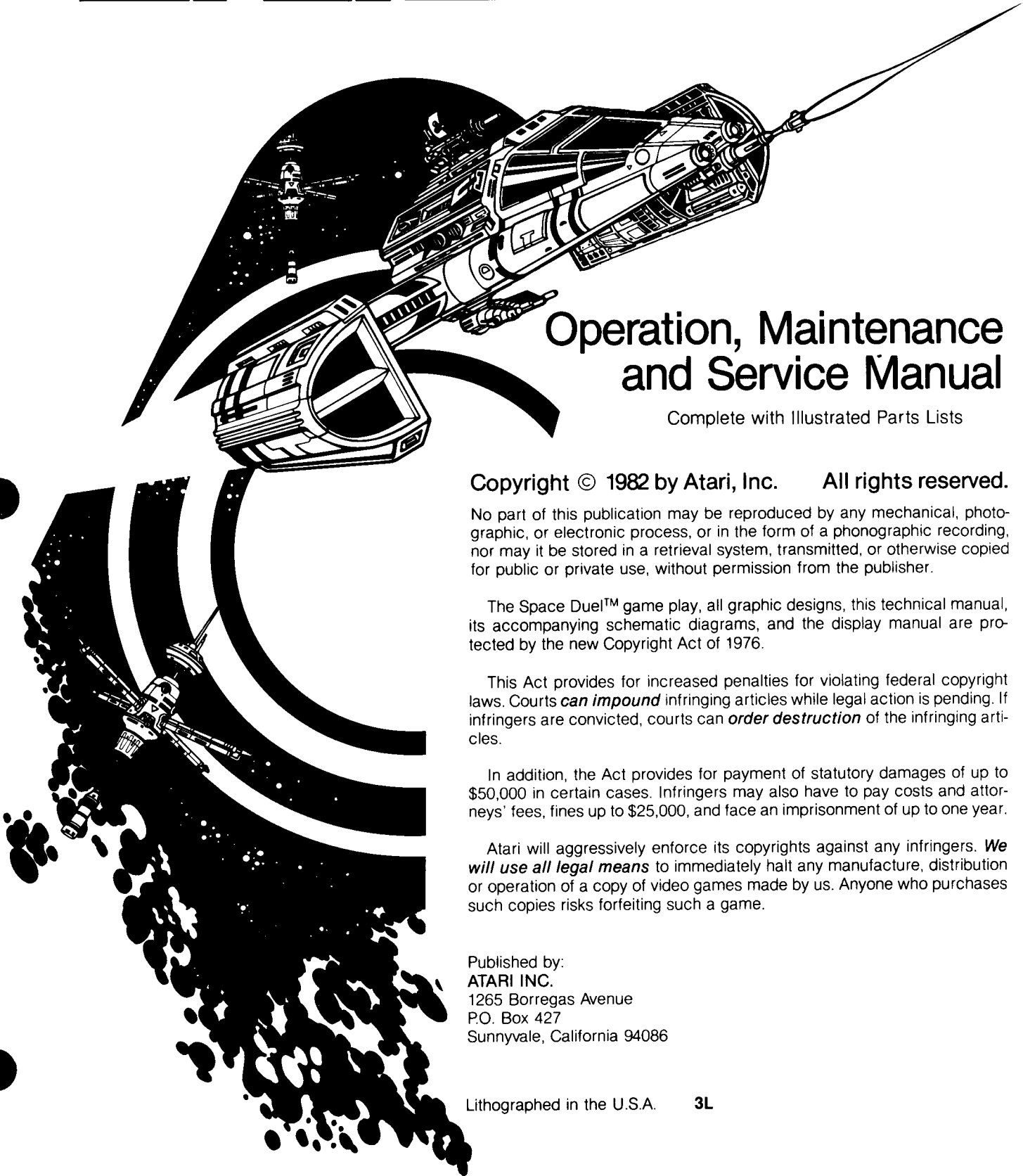

Operation, Maintenance and Service Manual

Complete with Illustrated Parts Lists

Copyright © 1982 by Atari, Inc. All rights reserved.

No part of this publication may be reproduced by any mechanical, photographic, or electronic process, or in the form of a phonographic recording, nor may it be stored in a retrieval system, transmitted, or otherwise copied for public or private use, without permission from the publisher.

The Space Duel™ game play, all graphic designs, this technical manual, its accompanying schematic diagrams, and the display manual are protected by the new Copyright Act of 1976.

This Act provides for increased penalties for violating federal copyright laws. Courts *can impound* infringing articles while legal action is pending. If infringers are convicted, courts can *order destruction* of the infringing articles.

In addition, the Act provides for payment of statutory damages of up to \$50,000 in certain cases. Infringers may also have to pay costs and attorneys' fees, fines up to \$25,000, and face an imprisonment of up to one year.

Atari will aggressively enforce its copyrights against any infringers. *We will use all legal means* to immediately halt any manufacture, distribution or operation of a copy of video games made by us. Anyone who purchases such copies risks forfeiting such a game.

Published by:
ATARI INC.
1265 Borregas Avenue
P.O. Box 427
Sunnyvale, California 94086

INTERFERENCE

to licensed communications services is not permitted by the
FCC (Federal Communications Commission)

If you suspect interference from an ATARI game at your location,
check the following:

- All grounds (green wires) in the game are properly connected
as shown in the game wiring diagram, and
- The game's power cord is properly plugged into a **grounded**
3-wire outlet.

If you are unable to solve the interference problem, please con-
tact:

Atari Customer Service

(800) 526-3849

or

(800) 538-1611

Notice Regarding Non-ATARI Parts

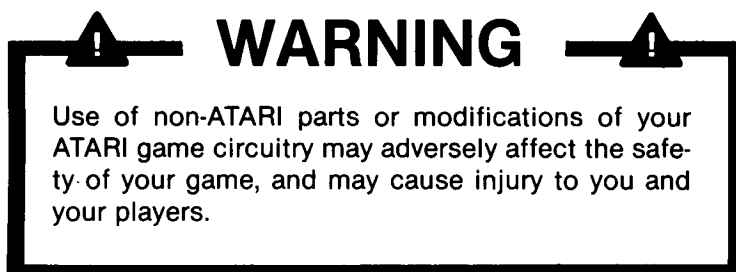

The warranty printed on the inside back cover of this manual may be voided, if you do any of the following:

- 1) you substitute non-ATARI parts in your coin-operated game, or
- 2) you modify or alter any circuits in your ATARI game by using kits or parts **not** supplied by ATARI.

Not only may the use of any non-ATARI parts void your warranty, but any such alteration may also adversely affect the safety of your game, and may cause injury to you and your players.

Table of Contents

1	Set-Up Procedures	
A.	New Features	1-1
B.	Opening the Cocktail Cabinet	1-3
C.	Game Inspection	1-4
D.	Game Installation	1-4
	1. Installation Requirements	1-4
	2. Voltage Selection	1-4
E.	Cocktail Table Legs	1-5
F.	Switch Locations	1-6
	1. On/Off Switch	1-6
	2. Cocktail Table Interlock Switch	1-6
	3. Utility Switches	1-6
	4. Option Switches	1-6
G.	Self-Test Procedure	1-8
H.	Option Switch Settings	1-10
I.	Game Play	1-12
	1. Attract Mode	1-12
	2. Ready-to-Play Mode	1-13
	3. Play Mode	1-13
	4. High Score Mode	1-14
2	Troubleshooting	
A.	Introduction	2-1
B.	Comments on Troubleshooting	2-2
C.	Self-Test Procedure	2-2
D.	Glossary of Schematic Signal Descriptions	2-6
3	Illustrated Maintenance, Repair and Parts	
	Maintenance, repair and parts lists begin on page	3-1

List of Illustrations

Figure 1-1	Game Overview	1-2
Figure 1-2	Adjusting the Table Legs	1-5
Figure 1-3	Game Switch Locations	1-6
Figure 1-4	Operator Information Display	1-8
Figure 1-5	Self-Test Procedure	1-9
Figure 1-6	Ready to Play Screen	1-13
Figure 2-1	Self-Test Screen if Test Passes	2-2
Figure 2-2	Self-Test Screen 1	2-3
Figure 2-3	Self-Test Screen 2	2-3
Figure 2-4	Self-Test Screen 3	2-4
Figure 2-5	Self-Test Screen 4	2-4
Figure 2-6	Self-Test Screen 5	2-4
Figure 2-7	Self-Test Screens During Signature Analysis	2-5
<i>Illustrated Maintenance, Repair and Parts:</i>		
Figure 3-1	Cabinet-Mounted Assemblies	3-2
Figure 3-2	The Control Panel	3-7
Figure 3-3	Control Panel Assemblies	3-9
Figure 3-4	Speaker, Fluorescent Tube and Fan	3-10
Figure 3-5	Video Display	3-12
Figure 3-6	Vertical-Mounted Coin Door	3-14
Figure 3-7	Printed-Circuit Board Removal	3-17
Figure 3-8	Space Duel™ PCB Assembly	3-18
Figure 3-9	Regulator/Audio II PCB Assembly	3-22
Figure 3-10	Color X-Y Power Supply Assemblies	3-24

List of Tables

Table 1-1	Game Options	1-10
Table 1-2	Game Price Options	1-11
Table 1-3	Special Options	1-11
Table 1-4	Space Duel Targets	1-14

NOTE

If reading through this manual does not lead to solving a certain maintenance problem, call TELEHELP® at the Atari Customer Service office in your geographical area, as shown below.

WEST and CENTRAL U.S.A.

Service only

Atari, Inc.
California Customer Service Office
1105 N. Fair Oaks Avenue
P. O. Box 427, Sunnyvale, CA 94086
Telex 17-1103
(Monday–Friday, 7:30–4:00 pm Pacific Time)

☎ From California, Alaska, or Hawaii
(408) 745-2900

☎ Service from anywhere in the area shown in white
toll-free (800) 538-1611

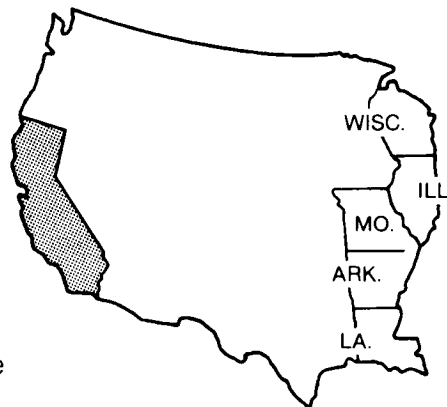

EAST U.S.A.

Service only

Atari, Inc.
New Jersey Customer Service Office
12A World's Fair Drive, Somerset, NJ 08873
Telex 37-9347
(Monday–Friday, 7:30–4:00 pm Eastern time)

☎ From New Jersey
(201) 469-5993

☎ From anywhere else in this area
toll-free (800) 526-3849



EUROPE

Service only

Atari Ireland Limited
European Customer Service Office
Tipperary Town, Ireland
Telex 28165
(Monday–Friday, 9:00–6:00 pm GMT)

☎ 062-52155

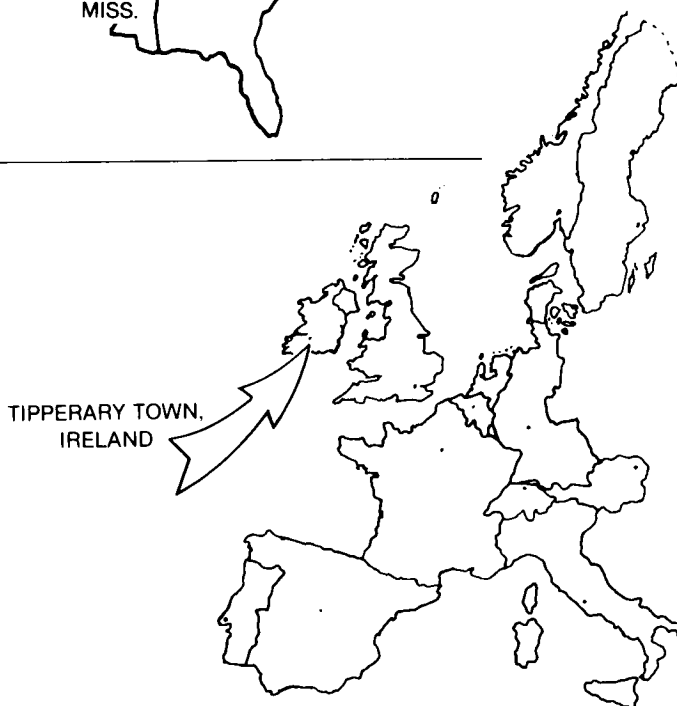

Set-Up Procedures

How to Use This Manual

This manual, written for game operators and service technicians, describes the Space Duel™ game.

The manual contains information about *all* Space Duel cabinets. Whenever information is unique to the Upright cabinet, this symbol appears:



Whenever information is unique to the Cocktail game cabinet, this symbol appears:



Chapter One includes new features, game set-up, self-test procedures, option switches and game play.

Chapter Two details troubleshooting procedures.

Chapter Three contains maintenance, repair and parts information.

In addition, schematic diagrams of the game circuitry are included with this manual.

Figures 1-1 and 3-1 illustrate the game cabinets. Suppose you need to find information about a specific part of a cabinet. These figures list other places in the manual to find information about that part.

A. New Features

The Space Duel™ game has three new features. Even if you are familiar with ATARI® games, you should note these important differences. The new features are:

- **Game Play.** Players may choose four different game versions. A single player may play fighters or space stations. Two players, playing at the same time, may play fighters or space stations. Players may compete against the game, or against each other and the game. There are 18 different waves, each offering a variety of targets (see *Section 1, Game Play*).
- **Game Cabinet.** The Space Duel Upright cabinet is no wider than any other Atari game cabinet, yet has enough space for two players to play side by side. The cabinet has four speakers, which provide exceptional audio.
- **Vertical-Mounted Coin Door.** This new door has two separately keyed doors. One door provides full access for servicing the coin acceptors and other electrical parts. The other door provides access to the cash. In addition, the **lockout coil** receives its power from the game PCB. If the PCB is not functioning properly, coins will be rejected.

These new features, as well as all other major parts in the game, are illustrated in Figure 1-1. Throughout this manual, wherever one of these new features is mentioned, you will see this symbol:

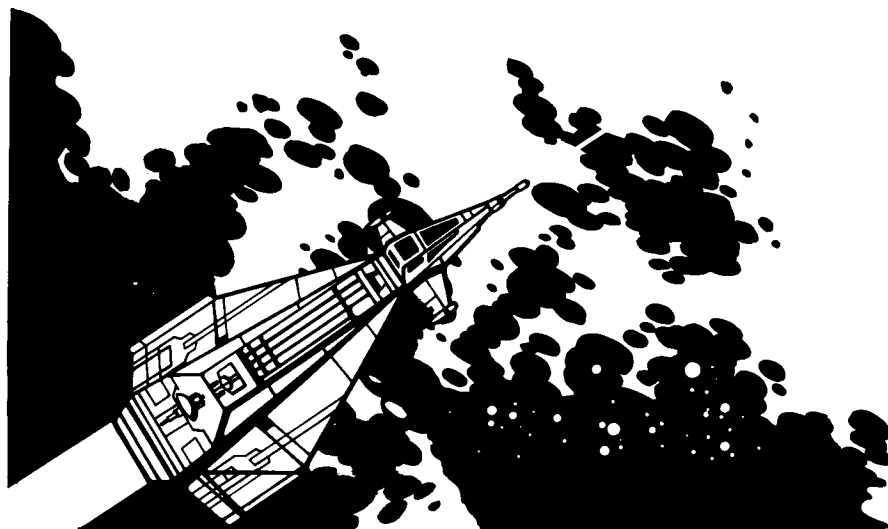

Chapter

1

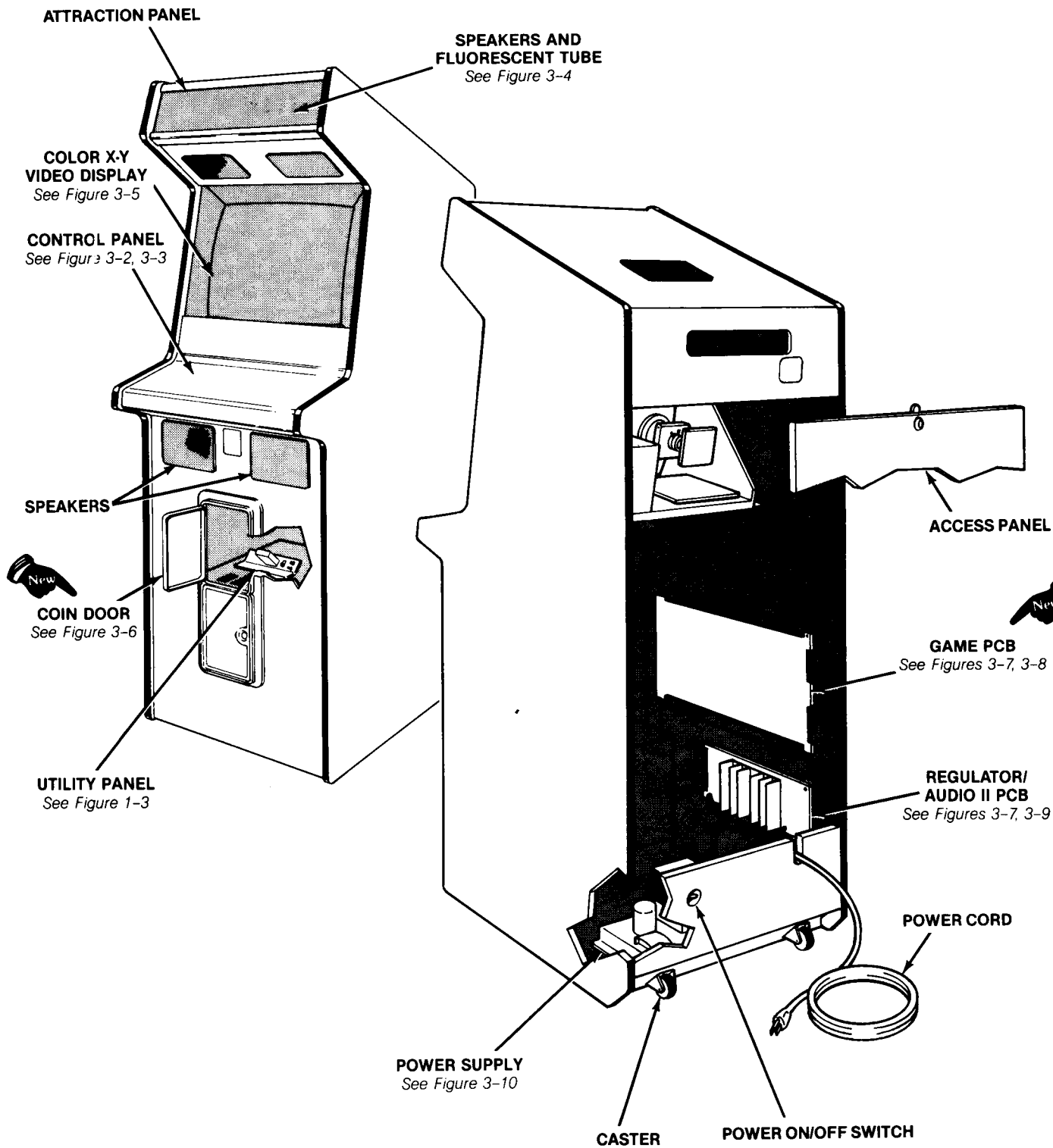

Figure 1-1 Upright Game Overview

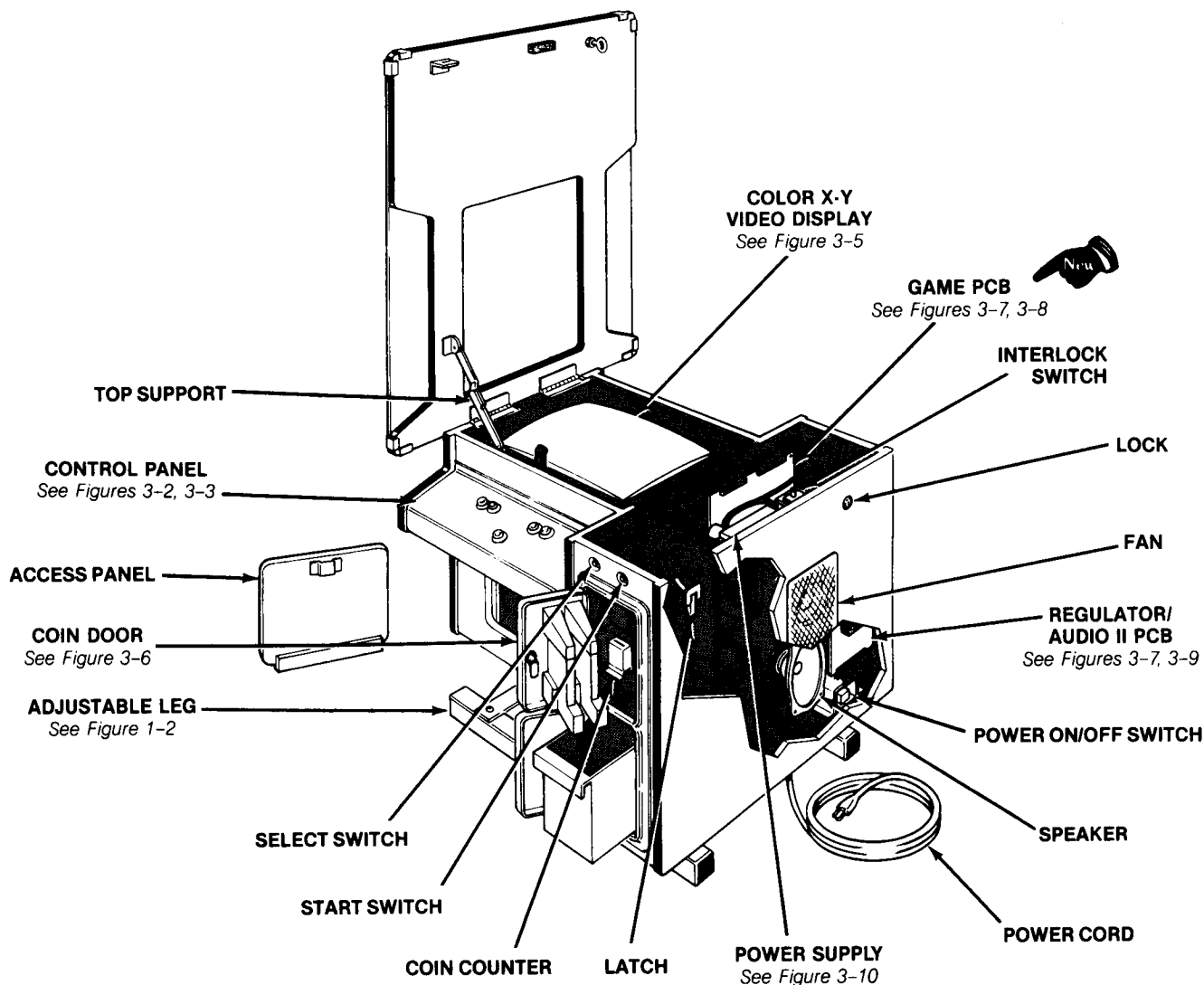

Figure 1-1, continued Cocktail Game Overview

WARNING:
SHOCK HAZARD

Connect this game only to a grounded 3-wire outlet. If you have only a 2-wire outlet, we recommend you hire a licensed electrician to install a grounded outlet. **Players may receive an electric shock if this game is not properly grounded!**

To prevent electric shock, disconnect power supply cord before opening service panel or servicing the game.

B. Opening the Cocktail Cabinet

1. Opening the Table Top

- To open the game cabinet, unlock and open the coin door. Reach inside and open the luggage-style latch located on the cabinet wall to your right. Next, unlock the lock at one end of the game, located immediately below the table top. (see Figure 1-1).
- Carefully lift the table top until the support arm locks into place. **Do not jam the table top at the end of its upward swing.**

2. Access Panel

- To open the access panel, lift out the steel security bar that secures the panel to the cabinet wall.
- The access panel near the bottom of the cabinet will then come out.

3. Closing the Table Top

- To close the cabinet, stand opposite the hinged end of the cabinet and grasp the table top with your right hand.
- With your left hand, press the button at the middle of the support arm and push the button out toward the left.
- **Gently** lower the table top to the closed position.
- Lock the key lock. Then reach inside the coin door and close the luggage-style latch. Lock the coin door.

C. Game Inspection

Please inspect your game carefully to insure that it was delivered to you in good condition.

NOTE

Do not plug the game in yet!

1. Examine the exterior of the game cabinet for dents, chips, or broken parts.
2. Remove the screws that were used as extra security to seal the access panel (for Upright Space Duel). Unlock and open this panel, the coin door, and the Cocktail table top. Inspect the interior of the game as follows:
 - Check that all plug-in connectors (on the game harness) are firmly seated. Replug any connectors found unplugged. **Don't force connectors together.** The connectors are keyed so they only go on in the proper orientation. **A reversed edge connector will damage a PCB** and will void your warranty.
 - Check that all plug-in integrated circuits on the game PCBs are firmly seated in their sockets.
 - Remove the tie-wrap that holds the coiled power cord on the inside cabinet wall. Check the cord for any cuts or dents in the insulation. Place the square black plastic strain-relief plate in the wood slot at the bottom of the rear panel opening (Upright only).



WARNING



To avoid possible unpleasant electrical shock, do not touch internal parts of the video display with your hands or with metal objects held in your hands!

- Note the location of the game's serial number—it is printed on the special label on the outside of the game cabinet. Verify that the serial numbers on the game PCB, Regulator/Audio II PCB, power supply and video display are all identical. A drawing of the serial-numbered components is on the inside front cover of this manual. Please mention this number whenever you call your distributor for service.
- Check all major subassemblies such as the power supply, control panel and video display for secure mounting.

D. Game Installation

1. Installation Requirements

Power	200 watts maximum
Temperature	0 to 38°C (32 to 100°F)
Humidity	Not over 95% relative
	<i>Upright Cabinet</i>
Space Required	64 × 80¼ cm (25¼ × 31½ in.)
Game Height	182 cm (71¾ in.)
	<i>Cocktail Cabinet</i>
Space Required	71¾ × 85 cm (28¼ × 33½ in.)
Game Height	68½ to 104 cm (27 to 41 in.)

2. Voltage Selection

The power supply used in this game operates on the line voltage of almost any country in the world. The power supply may come with either one, two or three colored voltage selection plugs.

Before plugging in your game, check your power supply. Make sure that the voltage selection plug on the power supply is correct for your location's line voltage. Check the wire color on the plug and see if it is correct per Figure 3-10.

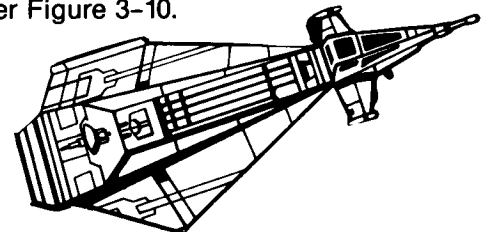

E. Cocktail Table Legs

 This cocktail-table game is designed for four adjustable heights—68½, 74, 80 or 104 cm (27, 29½, 31¼ or 41 inches). To adjust the table height, refer to Figure 1-2.

NOTE

To ensure cabinet strength, you **must** use two screws when attaching each table leg. Using only one screw may result in damage to the cabinet wall when you move the cabinet across the floor.

- Remove or empty the coin box. Loose coins may slide out of the box and into the game cabinet.
- Lay table on end as shown.
- Remove the two Allen-head screws on each leg. Grasp the legs and slide them into the desired position. Then replace the screws.

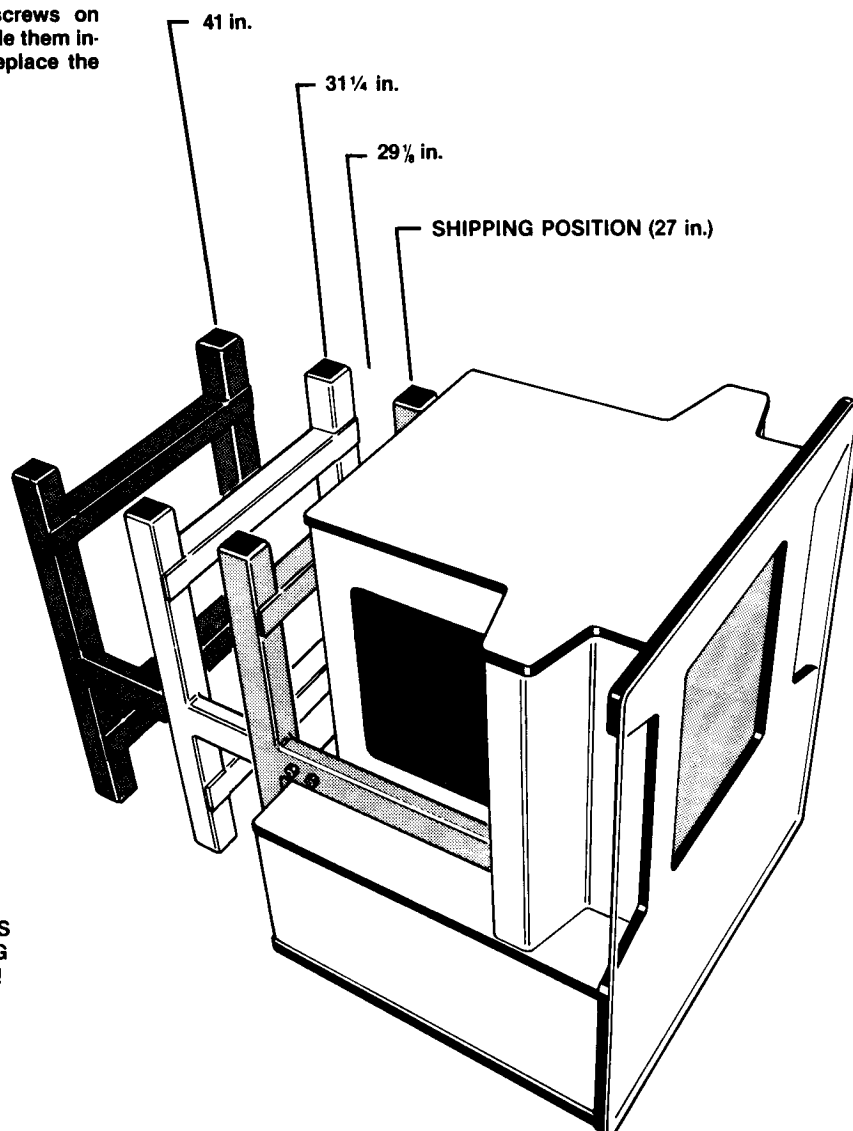

**USE TWO SCREWS
WHEN ATTACHING
EACH TABLE LEG!**

Figure 1-2 Adjusting the Table Legs

F. Switch Locations

1. On/Off Switch

The *Upright game* on/off switch is located on the back of the cabinet, lower left side. The *Cocktail game* on/off switch is located on the bottom of the cabinet, below the key lock (see Figure 1-3).

2. Cocktail Table Interlock Switch

To minimize the hazard of electrical shock while working on the inside of the game cabinet, an interlock switch has been installed. It is located under the table top (see Figure 1-3). This switch removes all AC line power from the game circuitry when the panel is opened.

Check for proper operation of the interlock switch by performing the following steps:

- Close the table top.
- Plug the AC line power cord into an AC outlet.
- Set the power on/off switch to the "on" position. Within 30 seconds the screen should display a picture.

- Slowly open the table top. The video picture should disappear when the top is lifted about 2½ cm (1 inch). Close and lock the table top.
- If the results of the preceding steps are satisfactory, the interlock switch is operating properly. If the video display doesn't go off as described, check to see if the interlock switch is broken from its mounting or stuck in the "on" position.

3. Utility Switches

The utility panel includes the volume control, self-test, coin switch, (and for the Upright game, coin counter). The Cocktail coin counter is inside the upper coin door. The coin switch is used to coin the game without tripping the coin counter. These switches are located inside the upper coin door (see Figure 1-3).

4. Option Switches

Option switches are located on the game PCB:

- Game play options are at PCB location D4.
- Game price options are at PCB location B4.
- Special options are at PCB location P10/11.

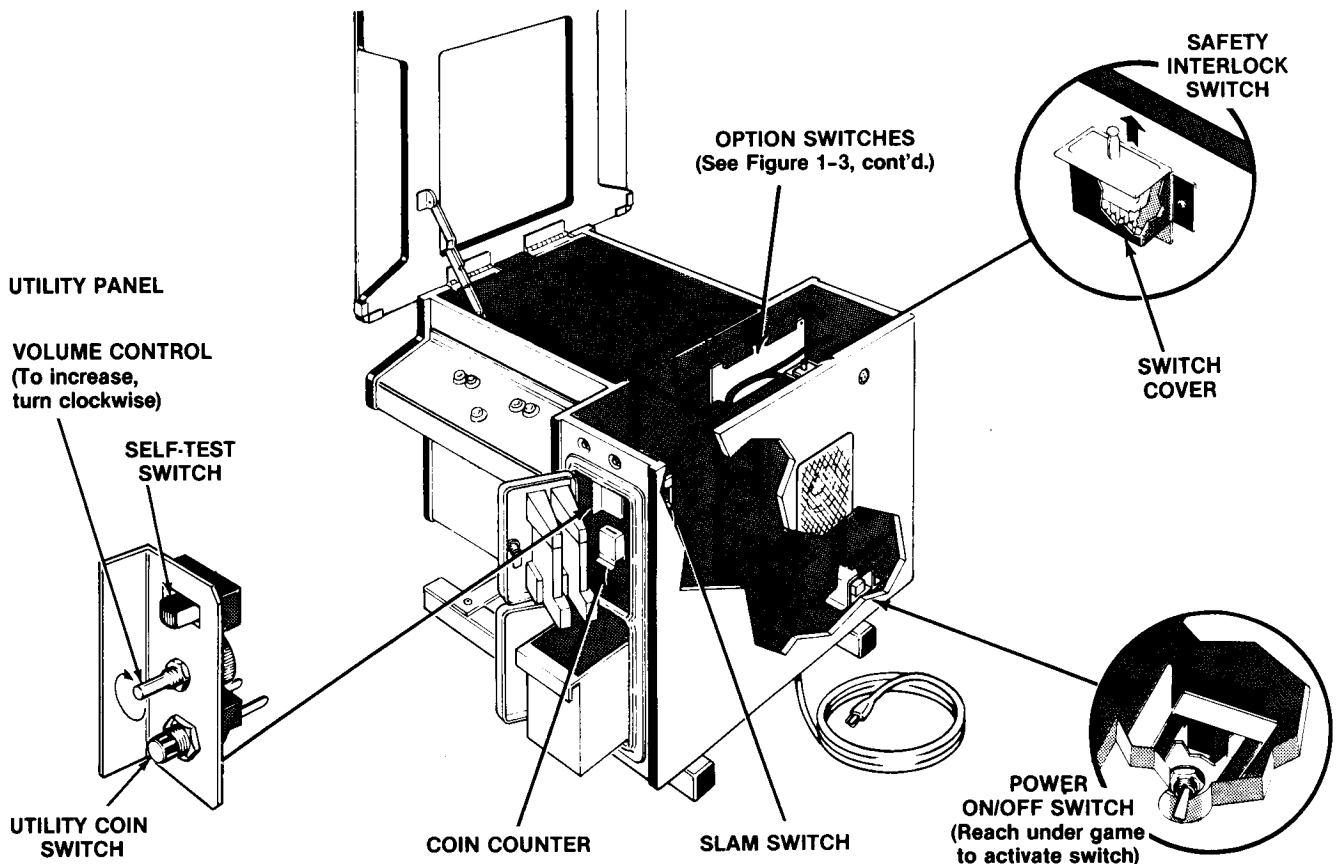

Figure 1-3 Cocktail Game Switch Locations

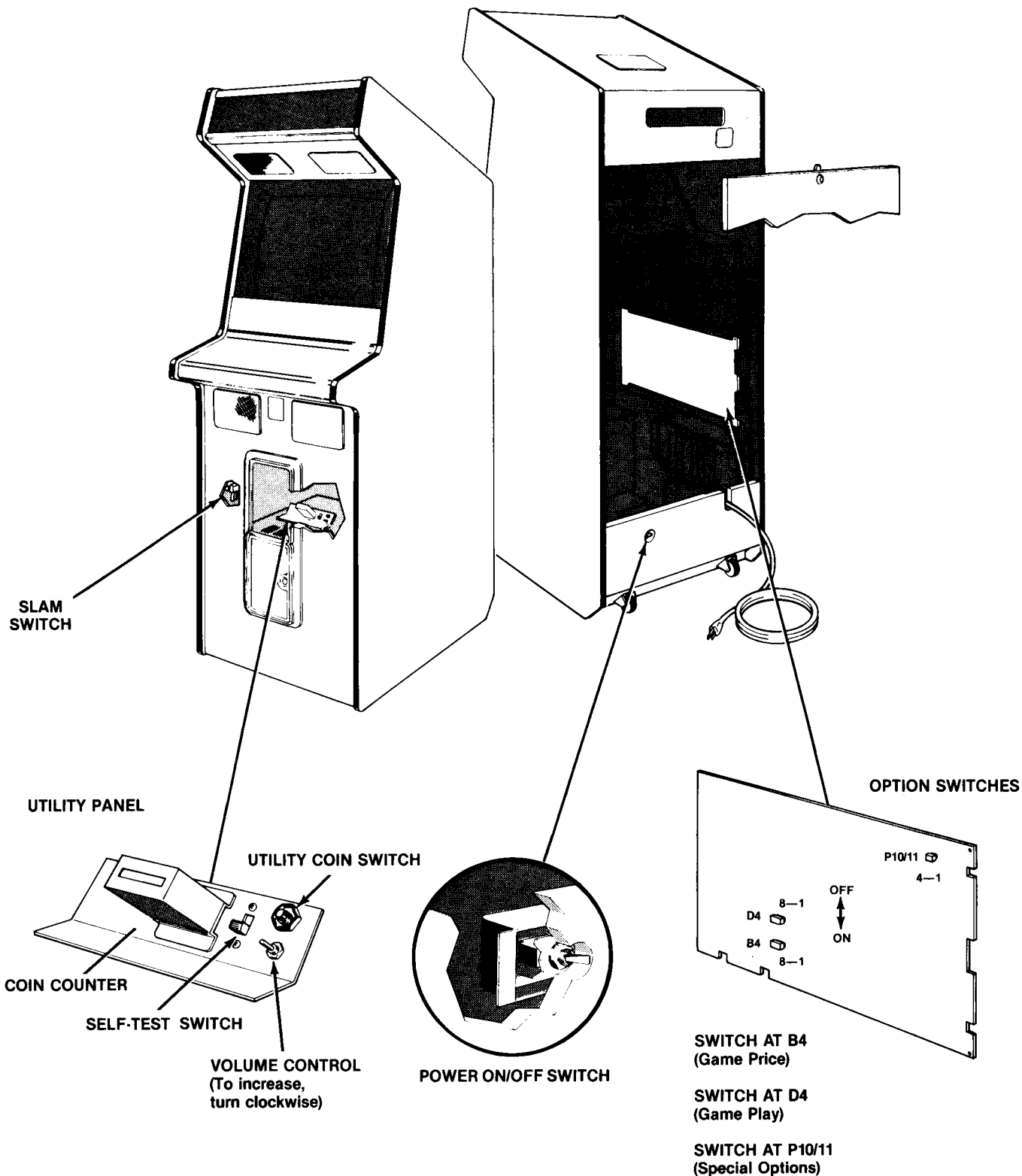

Figure 1-3, continued Upright Game Switch Locations

G. Self-Test Procedure

This game will test itself and provide data to show that the game's circuitry and controls are operating properly. The data is provided on the video display and speaker. No additional equipment is necessary.

We suggest you run the self-test procedure when you first set up the game, any time you collect money from the game, when you change game options, or when you suspect game failure.

Wait at least 10 seconds after playing a game before entering self-test. Otherwise, the high-score table may be erased and statistics get scrambled.

All credits will be cancelled when you enter self-test. All scores, except the top score in each game, will be reset to 5,000.

Refer to Figure 1-3 for the location of the self-test switch and option switches. To run the self-test, set the self-test switch to **on**. The screen will show the Operator Information Display (see Figure 1-4). To continue, 1) press RESET on the PCB, or 2) turn the power off and on again, or 3) follow the steps outlined in Figure 1-5. Use Figure 1-5 to check test results.

The complete self-test procedure is explained in *Chapter 2, Troubleshooting*. If any part of the test described in Figure 1-5 fails, refer to *Chapter 2*.

The Operator Information Display shows game statistics and option switch settings. In this mode you may also erase game scores and times. To enter this mode, set the self-test switch to **on**.

Look at the block of zeroes and ones at the top of the screen. If these numbers run together vertically, or do not line up horizontally, make adjustments to the X BIP and Y BIP potentiometers on the game PCB.

To enter Self-Test, press GAME SELECT until the message *PUSH START AND SELECT FOR SELF-TEST* appears on the screen. Then press both START and GAME SELECT. All credits will be cancelled when you go into self-test. To end the operator information display, set the self-test switch to **off**.

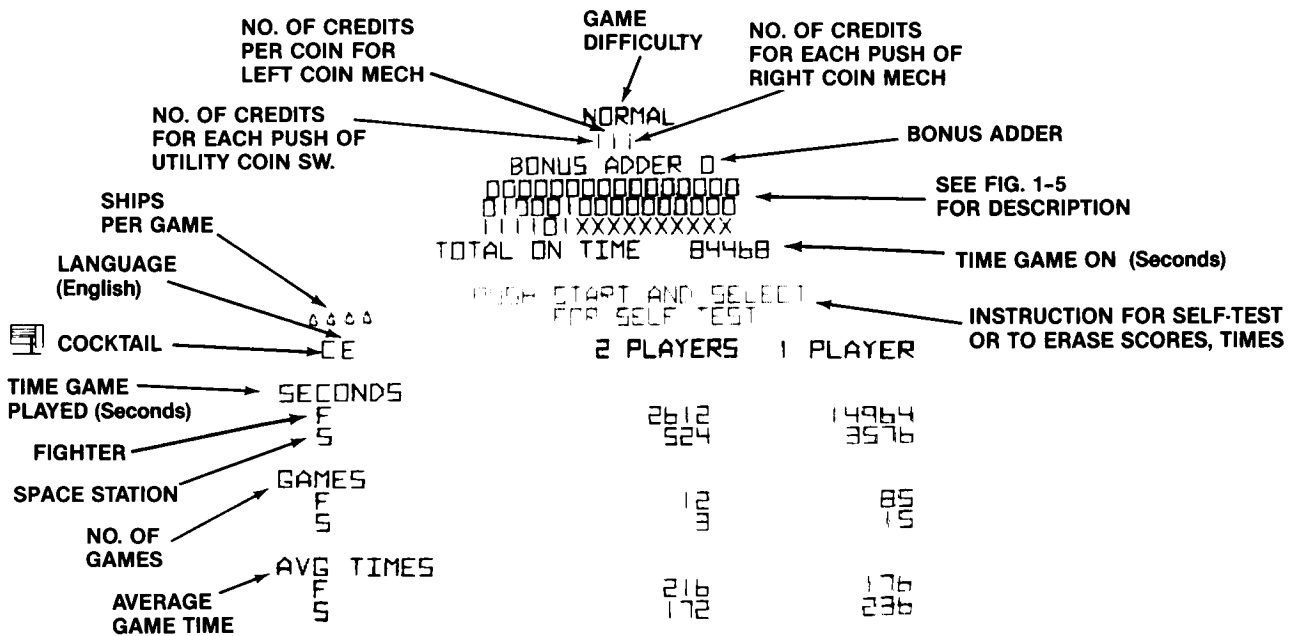

- To erase game scores:**
1. Push GAME SELECT until display reads *PUSH START AND SELECT TO CLEAR SCORES*.
 2. Press both START and SELECT.
 3. The word *ERASING* flashes on the screen until the entire table is erased. Wait until the word *ERASING* disappears before going on with other tests.

- To erase game times:**
1. Push GAME SELECT until display reads *PRESS START AND SELECT TO CLEAR TIMES*.
 2. Press both START and SELECT.
 3. The word *ERASING* flashes on the screen until the entire table is erased. Wait until the word *ERASING* disappears before going on with other tests.

- To erase game scores and times:**
1. Push GAME SELECT until display reads *PRESS START AND SELECT TO CLEAR TIMES AND SCORES*.
 2. Press both START AND SELECT.
 3. The word *ERASING* flashes on the screen until the entire table is erased. Wait until the word *ERASING* disappears before going on with other tests.

Figure 1-4 Operator Information Display

Instruction

1. Set the self-test switch to **on** (see Figure 1-3). Press **START** and **GAME SELECT** simultaneously.
2. Activate all control panel switches: select, start, rotate left and right, fire, shields and thrust. Activate the coin switches.
3. Observe the white frame at the sides of the screen.

Test Passes

After about 5 seconds, the screen displays the picture below*. No sounds are produced. The RAMs, ROMs and three other chips are tested. If the picture is different from the picture below, or there are sounds, refer to *Chapter 2, Troubleshooting*.

As the switch activates, you hear a beep, and 0 changes to 1 on the screen. If test fails, refer to *Chapter 2, Troubleshooting*.

Each frame corner should be within ¼-inch of each display bezel corner. If test fails, refer to *Chapter 2, Troubleshooting*.

*Only the white frame may appear for about 8 seconds if the *EAROM* is either new or contains bad data. To continue with self-test, press *slam* switch.

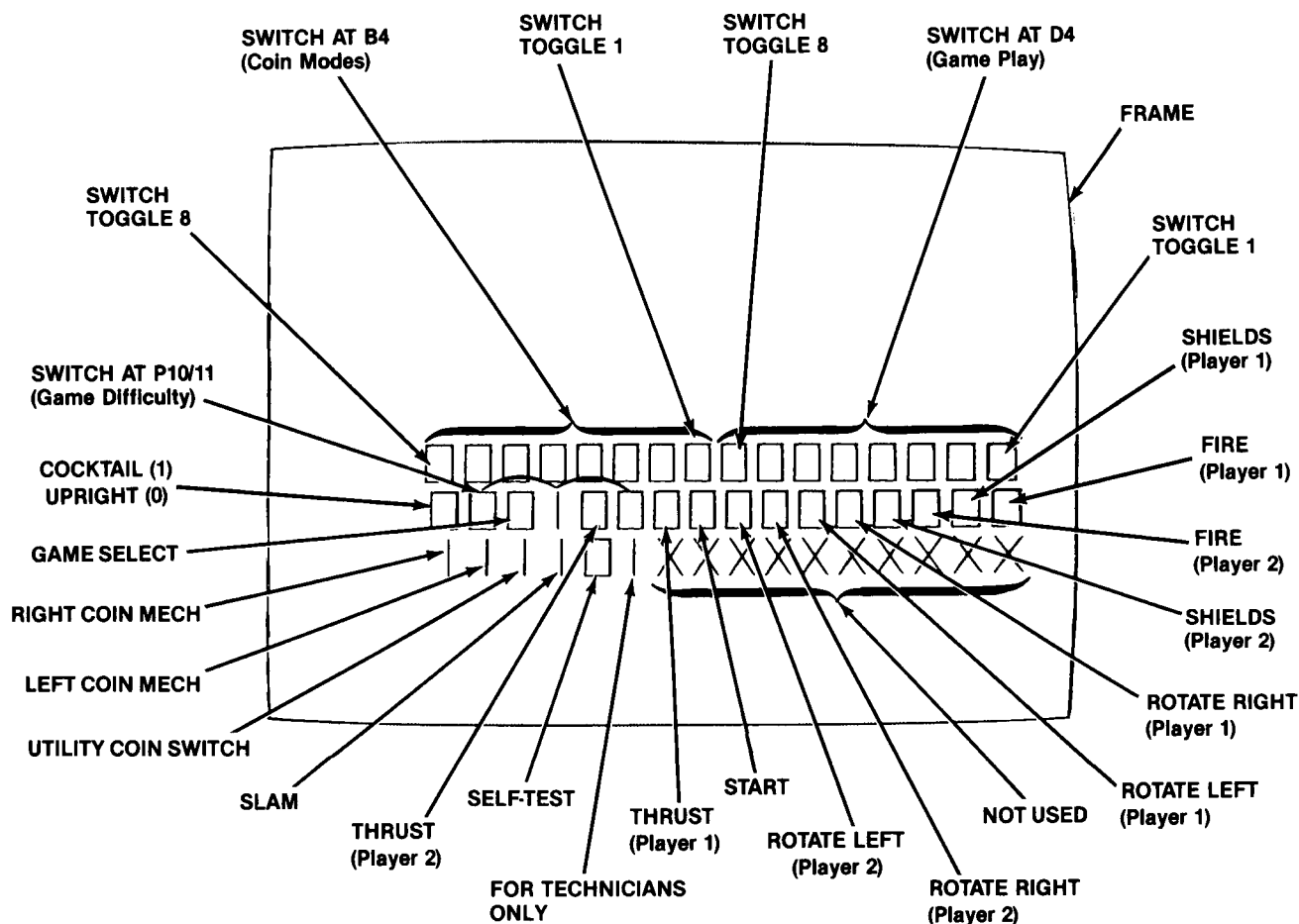

Figure 1-5 Self-Test Procedure

H. Option Switch Settings

Tables 1-1, Game Options; 1-2, Game Price Options; and 1-3, Special Options detail the options and their settings. All options are preset at the factory and shown by the \$ symbols. However, you may change the settings to suit your individual needs.

A special **Demonstration Mode** allows you to quickly view all 18 waves. To enter this mode, first set switch 3 at PCB location P10/11 to **on**. Next, set the game for free play by setting switch 7 at PCB location B4 to **on** and switch 8 to **off**. Press **GAME SELECT** to view the first wave. Each time you press **GAME SELECT** you will view the next wave in sequence. Ships must be alive on the screen for you to proceed through the waves. Otherwise, you must wait until the ship reappears to go to the next wave.

Table 1-1 Game Option Settings

To change toggle positions on the switch assemblies, you need **not** remove the game PCB. The switches are accessible when the Space Duel™ game PCB is mounted in place.

When changing the options, verify proper results on the video display by performing the self-test. Note that changing some options during the attract mode *may not* cause an immediate change on the screen.

Settings of 8-Toggle Switch on Space Duel game PCB (at D4)								Option
8	7	6	5	4	3	2	1	
On	Off							3 ships per game
Off	Off							4 ships per game \$
On	On							5 ships per game
Off	On							6 ships per game
		On	Off					Easy game difficulty*
		Off	Off					Normal game difficulty \$
		On	On					Medium game difficulty
		Off	On					Hard game difficulty
				Off	Off			English \$
				On	Off			German
				On	On			Spanish
				Off	On			French
								Bonus life granted at every:
						Off	On	8,000 points
						Off	Off	10,000 points \$
						On	Off	15,000 points
						On	On	No bonus life

\$Manufacturer's suggested settings

*Easy—In the beginning of the first wave, 3 targets appear on the screen. Targets increase by one in each new wave.

Normal—Space station action is the same as "Easy". Fighter action has 4 targets in the beginning of the first wave. Targets increase by 2 in each new wave. Targets move faster and more targets enter.

Medium and hard—In the beginning of the first wave, 4 targets appear on the screen. Targets increase by 2 in each new wave. As difficulty increases, targets move faster, and more targets enter.

Table 1-2 Game Price Options

The table below contains the switch settings for those options relating to game price, coin mechanism multipliers, and bonus play. The switches, on the game PCB at location B4, are accessible when the game PCB is mounted in place.

A special option allows you to charge by game *or* charge by player.

The *multipliers* (toggles 4-6) determine how much each coin mechanism will be worth to the game's logic. The coin door has two mechanisms.

The basic unit of measurement is 25¢ or 1 DM, which equals a multiplier of $\times 1$. Therefore, if you have a 2 DM/1 DM coin door, you may want to set the left multiplier at $\times 2$ and the right multiplier at $\times 1$.

You may offer *bonus play* for certain combinations of coins inserted. For example, with the game set at 25¢ per play, players who deposit four successive quarters, then press the start button, can receive a bonus play. Therefore, players can receive five plays for \$1.00. This bonus feature encourages players to insert more money than just the minimum 25¢ required for one game.

In the U.S., a "coin" is defined as 25¢. In Germany, a "coin" is 1 DM. To achieve bonus play, all coins must be inserted before pressing the start button.

Settings of 8-Toggle Switch on Space Duel game PCB (at B4)								Option
8	7	6	5	4	3	2	1	
Off	On							Free play
Off	Off							1 coin for 1 game (or 1 player)* \$
On	On							1 coin for 2 game (or 2 players)
On	Off							2 coins for 1 game (or 1 player)
		Off	Off					Right coin mech $\times 1$ \$
		On	Off					Right coin mech $\times 4$
		Off	On					Right coin mech $\times 5$
		On	On					Right coin mech $\times 6$
				Off				Left coin mech $\times 1$ \$
				On				Left coin mech $\times 2$
					Off	Off	Off	No bonus coins \$
					Off	On	Off	For every 4 coins inserted, game logic adds 1 more coin
					On	On	Off	For every 4 coins inserted, game logic adds 2 more coins
					Off	On	On	For every 5 coins inserted, game logic adds 1 more coin
					On	Off	On	For every 3 coins inserted, game logic adds 1 more coin**

* To charge by game: Toggle switch 4 at PCB location P10/11 to "on."

To charge by player: Toggle switch 4 at PCB location P10/11 to "off."

\$ Manufacturer's recommended settings

** In Operator Information Display, this option displays same as no bonus.

Table 1-3 Special Option Settings

Settings of 4-Toggle Switch on the game PCB (at P10/11)				Option
4	3	2	1	
			On	Credits counted on one coin counter.
			Off	Credits counted on two separate coin counters.
		On		1-player game only
	On			2-credit minimum*
On				Charge by game
Off				Charge by player**

* 2 credits must be purchased before player can start game.

** Each player must have a credit to play the game.

I. Game Play



The Space Duel™ game is a one- or two-player game with a color X-Y video display. This new display, with its 3 color guns and higher voltage, has the same technology that was used in previous Atari black-and-white X-Y displays. However, the screen now displays dazzling color and unique visual effects in a spectacular multi-dimensional video display.

Space Duel offers players a choice of four different game versions. One player can control a fighter or a space station. Two players, playing at the same time, can control fighters or a space station. The game offers players 12 different targets (7 split when hit), and 18 different waves. At the beginning of each wave, objects enter from the screen edge. The player(s) then tries to shoot and destroy the objects. The wave ends when all the objects are destroyed.

A special *Operator Information Display* shows game statistics and option switch settings. Enter this mode by turning the self-test switch to **on**. In this mode, you may clear the special "permanent" memory by erasing the high-score table or game-time information (see *Section G*).

A special *Demonstration Mode* allows you to view all waves as long as all ships are "alive" on the screen. In this mode you can see as many as 12 different targets (see *Section H*).

Space Duel™ has five possible modes of operation: attract, ready-to-play, play, high score and self-test. Self-test is a special mode for checking the game switches and computer functions. You may enter self-test at any time. Wait at least ten seconds after a game has been played before entering self-test or turning off the power. Otherwise, you may erase the high score table.

1. Attract Mode

The attract mode begins when power is applied to the game, after a play or high score mode, or after self-test. This mode is continuous and stops only when a credit is entered, or when in self-test. In the attract mode, the screen displays one of three possible pictures.

One of the pictures is the high score display which lasts about 8 seconds. The score(s) from the last game is displayed on the screen. The top five one-and two-player scores and their matching initials also appear for each type of game.

A second picture shows "Space Duel" letters on cubes. After a few seconds, ships and saucers appear. They shoot at the cubes. The cubes break into smaller cubes when hit, and disappear.

The third picture simulates game play. Fighters or space stations shoot at targets. In all pictures, game price information and number of ships appear at the top of the screen. Bonus level information and the copyright message appear at the bottom of the screen.

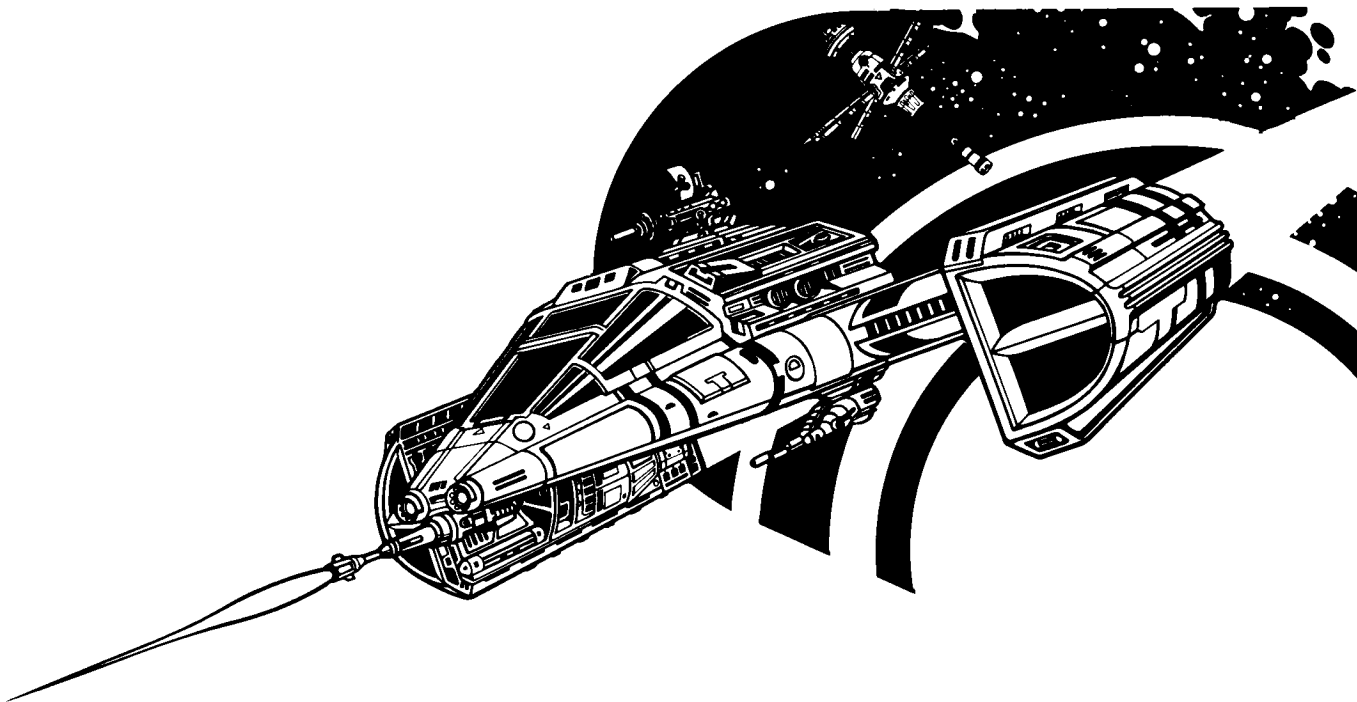

2. Ready-to-Play Mode

This mode begins when a credit is entered. The screen displays four game versions (see the picture that follows).

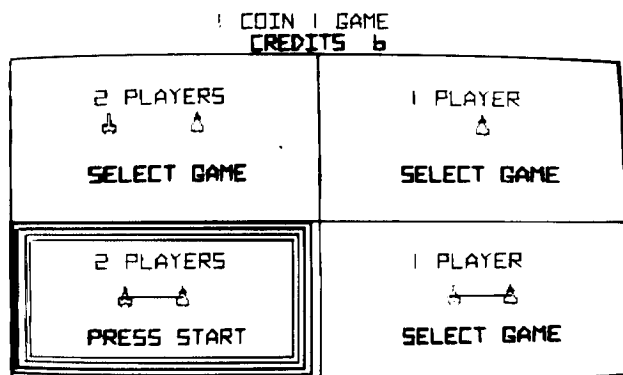

Figure 1-6 Ready-to-Play Screen

If you do not see this picture, set switch 2 at PCB location P10/11 to off.

At the bottom of the screen one of three messages appears:

- **ANOTHER COIN**—not enough coins inserted
- **SELECT GAME**—enough coins inserted
- **PRESS START**—coins inserted, game selected

You must press GAME SELECT at least once, and then press START, to enter the play mode.



3. Play Mode

The play mode begins with the first wave. In the space station game, two ships appear near the center of the screen. The ships are joined together by a "fuse." In the fighter game, the red ship appears above the red controls. The green ship appears above the green controls. A sound is heard any time a ship appears on the screen.

Player controls consist of ROTATE LEFT, ROTATE RIGHT, THRUST, SHIELDS, and FIRE pushbuttons. A ship may fire as many as four shots on the screen at one time. However, if a ship is damaged, it may fire only one shot on the screen. Also the ship is slower to react. In space stations, a second hit to either ship destroys that ship. Then, the fuse between ships starts to burn, and the other ship explodes.

In the fighter game, players may shoot each other without losing a life. Instead, the ship blinks and disappears. After a period of time, the ship reappears in a different location. If one player loses all of his ships before the other player, his last ship returns to the screen as a damaged ship. It is possible to earn a bonus ship while damaged.

Shields protect a ship from all saucer shots and collisions. Shields wear out with time or if hit by targets. Space stations have more than twice as much shield energy as fighters.

In the first wave, spinners enter and break into two smaller pieces when shot. Each piece splits into two smaller pieces when shot again. Each of these pieces is destroyed when shot. Other targets split apart in the same manner.

At the end of each wave, a bonus wave begins and a low humming sound is heard. **BONUS LEVEL**, and the number of points for that level, flash on the screen. A box appears at the screen edge and ships cannot leave that boundary. Fuzzballs, stars and saucers enter and attack the player. A fighter, when shot by the other player, either just before or during the bonus wave, will not reappear until the next wave. The bonus wave ends when all targets are destroyed, or the humming sound reaches its highest pitch.

Other targets enter as the game progresses. When the number of targets is less than the wave number, or if no splitting targets have been hit in some time, saucer enters and shoots at targets and ships. The saucer shots become more accurate as play continues. Saucers may also enter as a pair. They shoot at, but do not destroy, each other. Anything caught between them will be shot. Each time the pair goes across the screen, the distance between them increases.

A player's ship may be destroyed by a shot or collision. Game play ends when all ships are destroyed.

Hints for Game Play

- Move your ship around.
- Stay away from the screen edges.
- Leave some of the larger targets on the screen, and shoot the smaller (divided) targets first.
- Destroy all splitting objects to get into the bonus wave.
- Move toward the target to make your shot more accurate.
- In the fighter game, shoot the other ship for 500 points each hit.
- In the fighter game, shoot the other ship to renew his shield power.













- In the fighter game, shoot the other ship just before the bonus wave. This keeps him out of the bonus wave.
- In the space station game, too much thrust causes you to spin, making it difficult to control and straighten the station.

4. High Score Mode

This mode begins when a player has one of the five top scores. First, there is a fireworks display. Next, a player enters his initials following the instructions on the screen. Finally, the high score table for the version of game just played appears.

When you enter self-test, press reset, or turn the power off, all high scores are erased except the top score(s). The rest of the table is then reset at 5,000 points.

Table 1-4 Space Duel Targets

Target	Description	Wave First Appears	Points
Spinner	 Enters from screen edge. Splits into two smaller targets first time shot. Each target splits into two smaller targets next time it is shot. Each of these targets is destroyed next time shot.	1	20/50/100
Octahedron	 Action same as spinner.	2	20/50/100
Cube	 Action same as spinner.	4	20/50/100
Pentagon	 Action same as spinner.	7	20/50/100
Book	 Action same as spinner.	10	20/50/100
8-Pointed Star	 Action same as spinner.	13	20/50/100
Hexagon	 Action same as spinner.	16	20/50/100
5-Pointed Star	 Enters from screen edge when only a few targets remain. If star leaves screen, it returns as a fuzzball.	Bonus	200
Fuzzball	 Enters from screen edge and tracks the ships.	Bonus	200
Mine	 Enters from screen edge, tracks ships and speeds up as play progresses. When shot, stops and changes color. If hit enough times, it turns white. Can only be destroyed if shot when white.	1	100
Saucer	 Enters from screen edge when number of targets is less than the wave number. Shoots at targets and ships.	1	300
Saucer	 Enters the screen from edge when number of targets is less than the wave number. Shoots at targets and ships. Enter as a pair and shoot at, but do not destroy, each other. Targets between pair are shot. As play progresses, distance between pair increases.	1	300

Troubleshooting

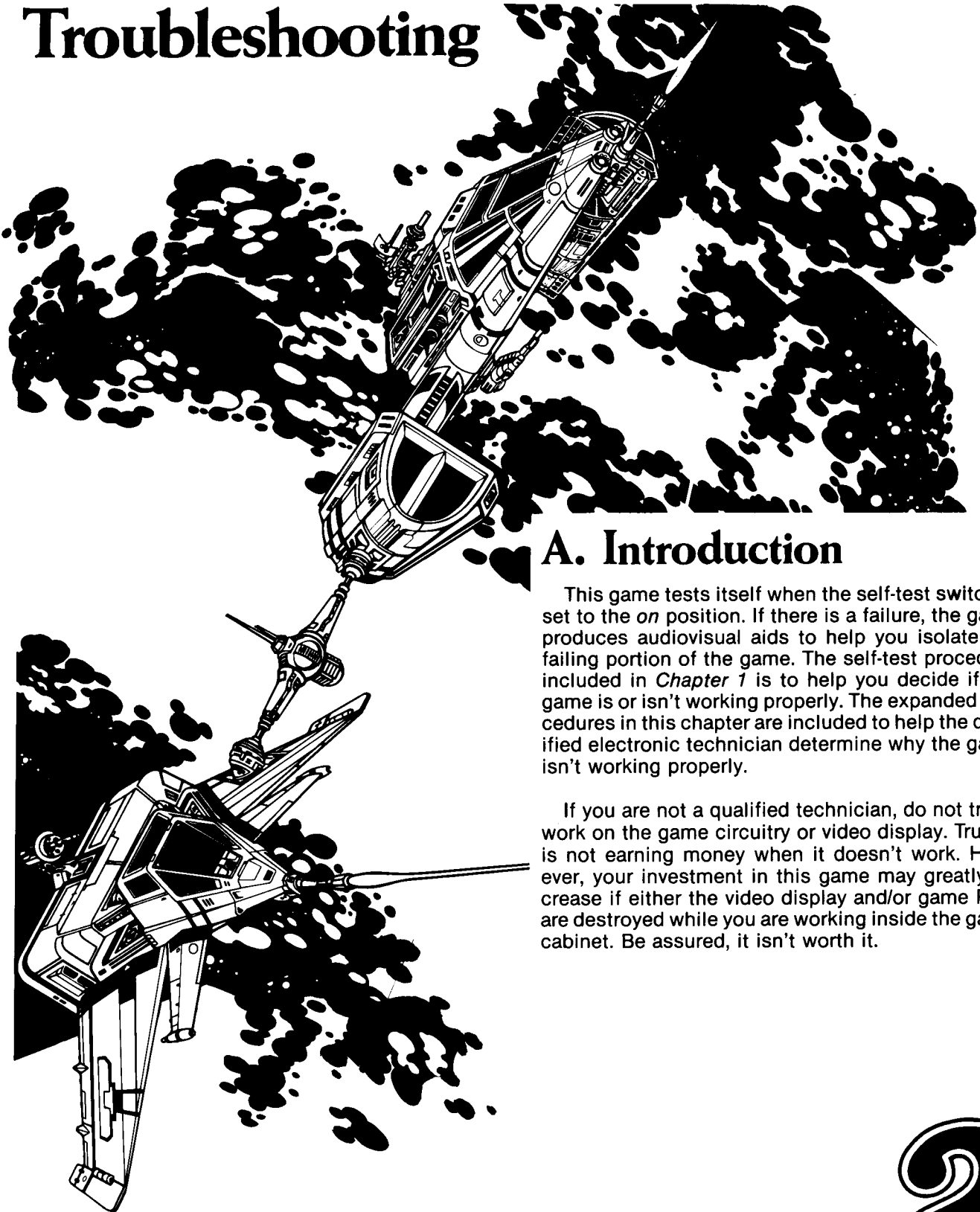

A. Introduction

This game tests itself when the self-test switch is set to the *on* position. If there is a failure, the game produces audiovisual aids to help you isolate the failing portion of the game. The self-test procedure included in *Chapter 1* is to help you decide if the game is or isn't working properly. The expanded procedures in this chapter are included to help the qualified electronic technician determine why the game isn't working properly.

If you are not a qualified technician, do not try to work on the game circuitry or video display. True, it is not earning money when it doesn't work. However, your investment in this game may greatly increase if either the video display and/or game PCB are destroyed while you are working inside the game cabinet. Be assured, it isn't worth it.

Chapter

2

B. Comments on Troubleshooting

When troubleshooting, first determine the symptom(s) of the failure. After determining the symptom, look over the wiring diagram and determine what assemblies could cause the failure. Could it be caused by the power supply, Regulator/Audio II PCB, or the color X-Y display?

The next step is to check all harness wires and connectors to the suspected failing assembly. If you find there is no harness or connector problem, substitute an assembly known to be good for the suspected failing assembly. If the game functions properly, you have successfully isolated the failure. If it doesn't, repeat the procedure with another assembly.

When you have isolated the failing assembly, you must troubleshoot that assembly and make the necessary repairs. If the assembly that is failing is the color X-Y display, we suggest that a qualified video display technician handle the troubleshooting and repair. If the power supply or Regulator/Audio II PCB is failing, troubleshooting and repair is relatively simple, as these assemblies are not too complicated. If the game PCB is failing, troubleshooting and repair will greatly depend on your understanding of the operation of this PCB.

To effectively troubleshoot problems of the game PCB, it is necessary for you, the technician, to become familiar with the PCB's hardware. The diagrams in the schematic package (included with the game) show the functions of the circuitry. Again, while troubleshooting this PCB, first determine the symptom of the failure, then locate the suspected area on the schematic diagram.

To determine if the ROM of the game PCB that contains the self-test is functioning properly, perform signature analysis as described on the schematic diagrams. The signatures for the circuitry (printed in blue) are on the schematic diagrams at the proper test-node points.

A glossary of schematic signal descriptions is included at the end of this chapter. Each signal description states whether the signal is hardware- or software-generated, where it is generated, where the signal goes, and what the signal does to the circuitry. We suggest you use this glossary to become more familiar with the game PCB's operation.

C. Self-Test Procedure

To enter Self-Test, set the self-test switch to the *on* position. Then press the START and GAME SELECT buttons simultaneously.

If the test passes, the screen goes blank for a few seconds, then Figure 2-1 is displayed, and the game will be silent.

Results if Test Fails:

In addition to the following failure indications, be sure to see the procedure for troubleshooting the game PCB with the CAT Box, at the end of the schematics.

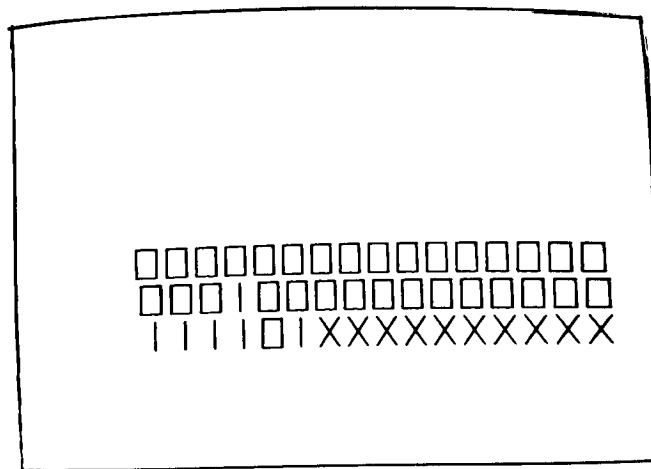

Figure 2-1 Self-Test Screen if Test Passes

NOTE

This procedure does not test the coin door lockout coils. If the self-test passes, but the lockout coils do not energize when the self-test switch is set to *off*, suspect the lockout coil wiring, coin door harness, game PCB harness, latch R9, or driver Q2 of the game PCB.

SCREEN 1:

SWITCH FAILURE is indicated by a constant tone. This means a switch is stuck in the closed position. Refer to Figure 1-5 for those switch locations.

RAM FAILURE is indicated by a sequence of 1 to 6 tones and an *R* displayed in the top center of the screen. Count the tones: the high one indicates the

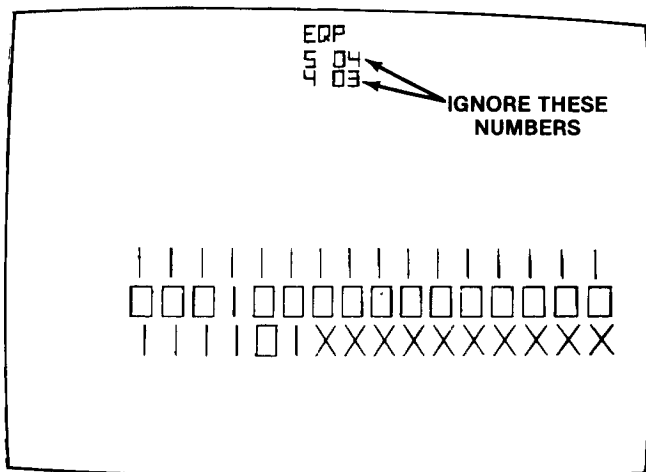

Figure 2-2 Self-Test Screen 1

bad RAM chip, as listed in the following table. NOTE: If either of the first two RAM chips are bad, self-test can only produce the first two tones, not the whole sequence. You must replace the defective RAMs H1 or E1 so the rest of the self-test can work properly.

High Tone	Bad RAM chip location on Game PCB
1st	H1
2nd	E1
3rd	K7
4th	M7
5th	J7
6th	L7

ROM FAILURE is indicated by one or more vertically arranged numbers displayed in the top half of the screen, as shown in Figure 2-2. Ignore the right pair of numbers—the left number(s) indicates the following bad ROM(s):

Displayed Number	Bad ROM Chip Locations
6	J1
5	K/L1
4	M1
3	N/P1
2	R1
1*	N/P7
0*	R7

*If either or both of these ROMs are bad, you will hear a constant or intermittent low tone, and the program may be unable to display a screen image.

EAROM OR CUSTOM I/O CHIP FAILURE is indicated by single letters in the top center of the screen. Identify the failure with the table below.

Displayed Letter	Bad Chip Location
E	EAROM at M2
P	Custom I/O Chip at C/D3
Q	Custom I/O Chip at B3

To proceed to screens 2 through 5, close the slam switch or ground the DIAG STEP pad on the game PCB for each screen. By closing the slam switch, you can cycle through this group of screens.

SCREEN 2:

A white diagonal grid pattern appears, along with the complete character set as shown in Figure 2-3. The corners of the grid pattern should touch the corners of the screen.

If the display is not centered, symmetrical, or the proper size, adjust the X and Y SIZE, CTR, and LIN pots on the game PCB (see Space Duel™ Schematic Package, SP-181). If the characters are incorrect, check again for a 0 or 1 displayed in the preceding ROM failure test.

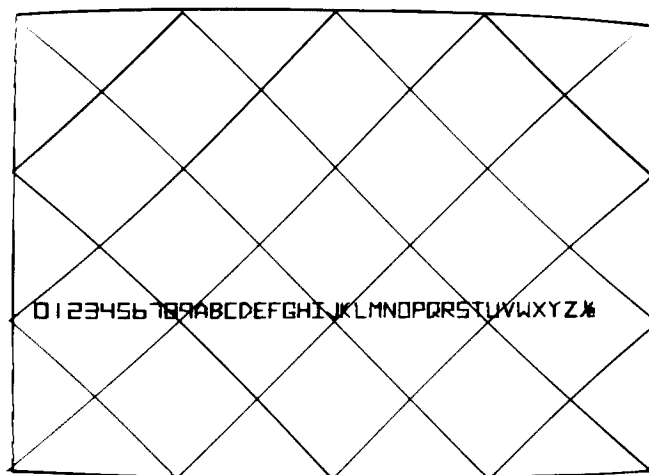

Figure 2-3 Self-Test Screen 2

SCREEN 3:

First, this test checks the two custom I/O chips' audio outputs. This is done in an eight-beep progression. There are four tones, starting with the highest tone loud, then soft, then a lower tone loud, then soft. After two more tones, each loud then soft, the sequence repeats. Each loud tone tests the output of custom I/O chip at location C/D3, and each soft tone tests the chip at B3.

No sound indicates failure of an audio amplifier, the custom I/O chip(s), and/or the game harness.

Second, this test checks the vector-generator binary scaling circuitry. During the first beep, the boundary of the display is brighter. During the third beep, a rectangle half the size of the boundary is displayed. With each of the next six beeps, the rectangle is displayed one-half the previous size. This rectangle then snaps back to full size, and repeats this shrinking sequence.

If the display skips one of the seven rectangles, or if the progression is not one-half the previous rectangle, there is a problem in the scaling circuitry.

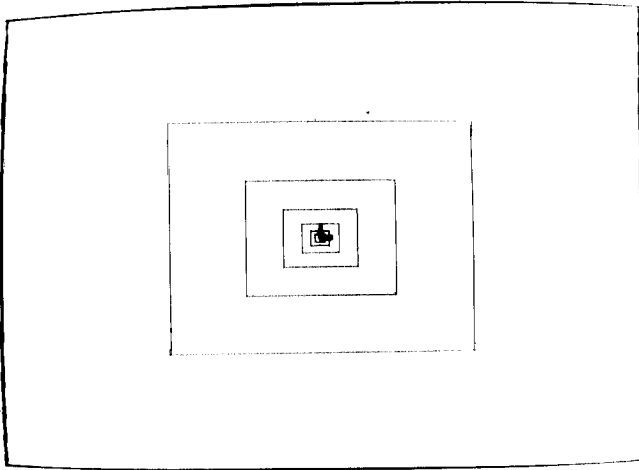

Figure 2-4 Self-Test Screen 3

SCREEN 4:

This test checks the seven screen colors and six intensities of each color (see Figure 2-5).

If the intensities don't progress from dim at the top of each color group to bright at the bottom, there is a problem in the Z-axis of the PCB or the display.

If the colors are not as shown in Figure 2-5, there is a problem with the R-G-B output of the PCB or the circuitry of the display.

Use this pattern for tracking adjustments (see the Color X-Y Display Manual).

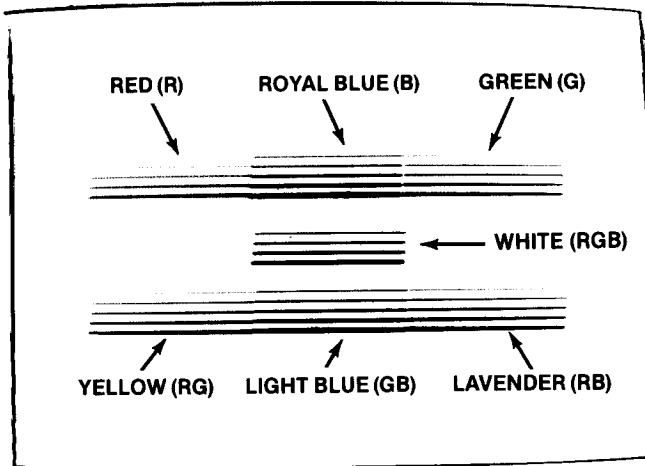

Figure 2-5 Self-Test Screen 4

SCREEN 5:

A grid pattern touches the corners of the video display, as shown in Figure 2-6. Press the GAME SELECT button to change its color. Use this pattern for purity and convergence adjustments (see Color X-Y Display Manual).

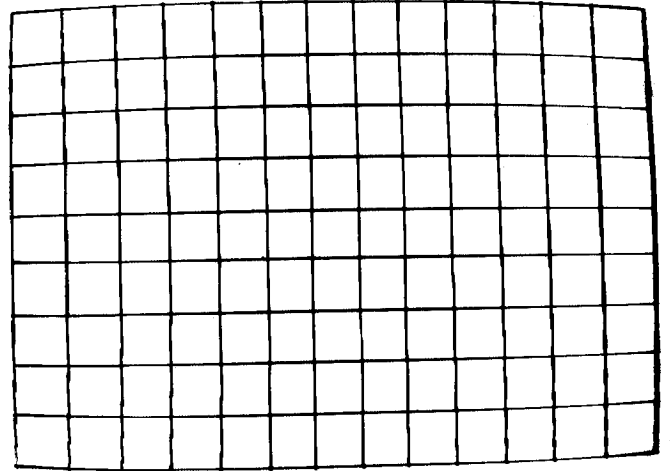

Figure 2-6 Self-Test Screen 5

SCREEN 6:

To display this screen, hold down GAME SELECT button while either closing the slam switch or grounding the DIAG STEP pad on the game PCB. To exit from this screen, turn off the self-test switch or press the RESET switch on the game PCB.

When this test is entered, the screen will either be blank or display vectors, depending on settings of the switch toggles at location P10/11 on the game PCB. These screens are shown in Figure 2-7.

VECTOR-GENERATOR DIAGNOSTIC PROGRAM

The diagnostic program is controlled by switches 2, 3, and 4 in the 4-toggle option switch bank at location P10/11 on the game PCB. This group of switches lets you choose one of six tests.

These tests provide recurring sequences to make it easy for you to troubleshoot the vector-generator circuitry. The tests and their respective option switch settings are as follows:

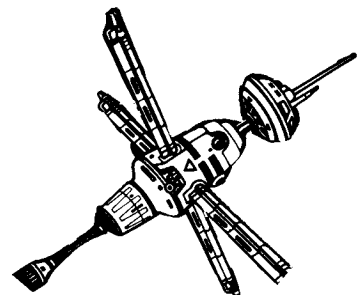

The last step of troubleshooting is to perform the tests described below.

		Settings of 4-Toggle Switch Assy. at P10/11:		
		4	3	2
Test 1	Do nothing but hit WDDIS every 4 msec (blank screen)	Off	Off	Off
Test 2	Test vector-generator halt instruction every .55 msec (blank screen)	On	Off	Off
Test 3	Test vector-generator long vector (and halt instruction) every 8.2 msec	Off	On	Off
Test 4	Test vector-generator jump instruction (and long vector and halt instruction) every 8.2 msec	On	On	Off
Test 5	Test vector-generator short vector instruction (and all of Test 4) every 8.6 msec	Off	Off	On
Test 6	Test vector-generator JSRL/RTSL instructions (and all of Test 5) every 10.2 msec	On	Off	On
Test 2	(Blank screen)	Off	On	On
Test 2	(Blank screen)	On	On	On

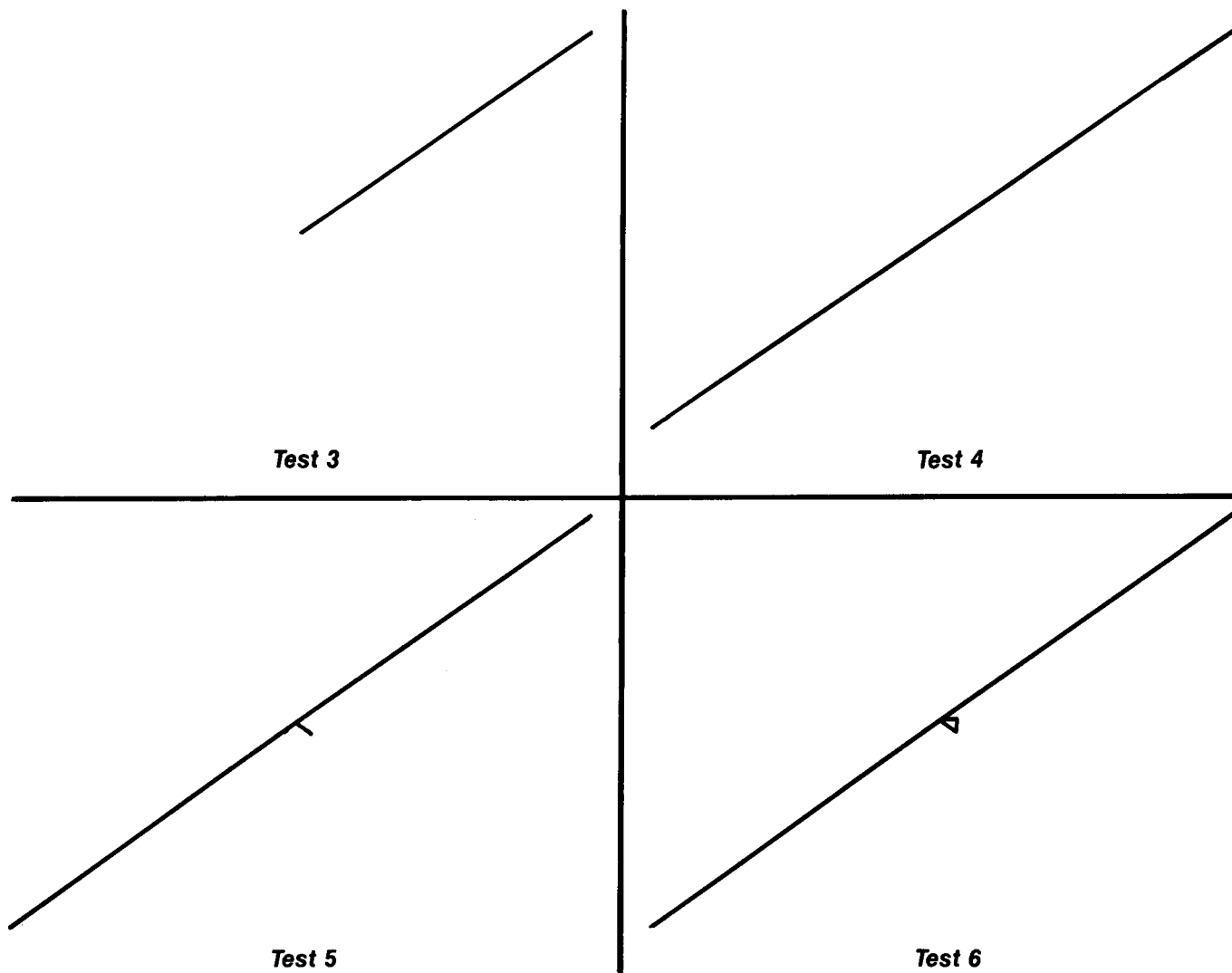

Figure 2-7 Self-Test Screens During Signature Analysis

D. Glossary of Schematic Signal Descriptions

(Signals Listed in Alphabetical Order)

AM0 through AM12

Software-generated vector-generator read-only memory (ROM) or random-access memory (RAM) address inputs. These signals are equal to the microprocessor address lines AB0 through AB12 when the microprocessor is addressing the vector-generator memory (VMEM is low). These signals are equal to the vector-generator address lines AVG0 through AVG12 when the vector-generator program memory is not addressed by the microprocessor (VMEM is high).

AUD1 and AUD2

Software-generated audio signals from custom I/O chips B3 and C/D3, amplified by operational amplifiers B5 and D5.

AVG0 through AVG12

Software-generated vector-generator address lines from vector-generator address controller J9. These lines address the vector-generator program memory ROM or RAM through the vector-generator address selector, when the microprocessor is not addressing vector memory (VMEM is high).

B ϕ 2

Hardware-generated signal from the internal clock circuitry of the microprocessor and buffered by B1. When B ϕ 2 is high, address decoder L4 is enabled for the microprocessor to:

- Enable EAROM M2 in the high-score table circuit,
- Write to EAROM M2,
- Write an interrupt-acknowledge decode output to microprocessor IRQ counter J4,
- Reset the vector-generator halt flag,
- Clear the watchdog counter,
- Clear the vector-generator halt flag, or
- Write to the coin door outputs.

BUFFEN

Active low software-generated signal from the vector-generator address selector multiplexer K8. This signal is directly from the microprocessor B ϕ 2 signal. When low, BUFFEN enables vector memory data buffer P8 when the microprocessor is accessing vector memory.

CENTER

Software-generated signal that is active low when CNTR or HALT is low. This signal closes switch B10 of the X-axis output and E10 of the Y-axis output, resulting in bleeding the charges of X- and Y-axis holding capacitors C78 and C75. This centers the beam on the display.

DISRST

Software-generated signal from the output of OR gate L6 that is low when either RESET from the microprocessor's watchdog circuit or VGRST from the microprocessor's address decoder is low. When DISRST is low, the HALT output of the latch is pre-set high; the Z-axis data latch E6 is cleared; the Z-blanking counter M3 is cleared; the state machine latch R4 is cleared; and the color data latch K10 is cleared.

DVG0 through DVG7

Software-generated vector-generator data lines from the vector-generator program memory ROM or RAM. These data lines are fed to the vector-generator data shifters or to the microprocessor data bus.

DVX0 through DVX12

Software-generated signals from vector-generator data shifter shift registers A8, C8 and B8, and from latch C6. The DVX3 through DVX11 inputs to the digital-to-analog converter (DAC) A/B9 represent the X-axis change from the current location of the display beam. If DVX12 is low, the DAC operates only in its lower 512 positions, or a negative direction of change. If DVX12 is high, the DAC operates only in its upper 512 positions, or a positive change.

DVY0 through DVY12

Software-generated signals from vector-generator data shifter shift registers F8, J8 and H8, and from latch D6. The DVY3 through DVY11 inputs to DAC F9 represent the Y-axis change from the current location of the display beam.

If DVY12 is low, the DAC operates only in its lower 512 positions, or a negative direction of change. If DVY12 is high, the DAC operates only in its upper 512 positions, or a positive change.

The DVY0 through DVY2 signals also represent the eight color inputs of R-G-B latch K10; DVY4 through DVY7 represent the Z-intensity input of Z-axis latch E6; and DVY8 through DVY10 represent the number that the vector draw time is divided by in the scaling circuit. The draw time is divided by 2^n ($n = \text{DVY8 through DVY10 binary number}$).

EAROMCON

Software-generated signal from microprocessor address decoder L4 at address 0E80. This signal

clocks microprocessor data bits DB0 through DB3 to the control inputs of high-score table electrically alterable ROM (EAROM) M2.

EAROMRD

Active low software-generated signal from microprocessor address decoder K6 at address 0A00. This signal enables the eight data bits of EAROM (electrically alterable ROM) M2 to be passed through buffer H2 of the high-score table.

EAROMWR

Active low software-generated signal from microprocessor address decoder L4 at address 0F00 through 0F3F. This signal clocks microprocessor address bits AB0 through AB5 and data bits DB0 through DB7 to the address and data bit inputs of high-score table EAROM M2.

GO

Software signal in the vector-timer circuit that is active high when VCTR or CNTR is high. When GO goes high, the vector timer counts, at a 12-MHz rate, to its maximum count of 256, if OP1 is high and $\overline{OP1}$ is low, or to 16K, if OP1 is low and $\overline{OP1}$ is high. When the timer reaches its maximum count, \overline{STOP} goes low, setting the VCTR and CNTR flag signals low on the next falling edge of 12 MHz.

HALT and \overline{HALT}

Software-generated signal from the halt flag that disables the halt and VCTR flags with its \overline{HALT} output. The status of the HALT signal is read by the microprocessor on its buffered data input DB6 of the microprocessor's switch input buffer M9 when $\overline{SINP1}$ is low.

HALT*

This signal results when the HALT signal has been delayed by one pulse of inverted VGCK (1.5 MHz), which in turn has been delayed by one pulse of 12 MHz. This signal is ORed together with GO and is the most-significant-bit address input of the state machine ROM.

INTACK

Active low software-generated signal from microprocessor address decoder L4 at address 0E00. This output is an acknowledgment from the microprocessor that it has received an interrupt request from the microprocessor's IRQ circuitry.

INVERT X

Active high software signal from the coin door and control-panel output circuits. When this signal is latched high at the output of latch R9, switch B10 in the X-axis output circuit is closed, inverting the X-axis vector instruction to the display through inverter K9.

INVERT Y

Active high software signal from the coin door and control-panel output circuits. When this signal is latched high at the output of latch R9, switch E10 in the Y-axis output circuit is closed, inverting the Y-axis vector instruction to the display through inverter K9.

I/O \overline{S}

Active low software-generated signal from two ORed outputs of microprocessor address decoder P3. At addresses 1000 through 100F and 1400 through 140F, $\overline{I/O\overline{S}}$ is low, thus enabling bidirectional buffer F5 for the microprocessor to read data from custom I/O chips B3 or C/D3.

I/O0

Active low software-generated signal from microprocessor address decoder P3 at addresses 1000 through 100F. When low, this signal enables custom I/O chip C/D3.

I/O1

Active low software-generated signal from microprocessor address decoder P3 at addresses 1400 through 140F. When low, this signal enables custom I/O chip B3.

LATCH0

Active low software-generated signal from the vector-generator state machine ROM decoder H7. When $\overline{LATCH0}$ is low, data bits DVG0 through DVG7 are transferred to the DVY0 through DVY7 outputs of shift registers F8 and J8 on the next rising edge of 12 MHz.

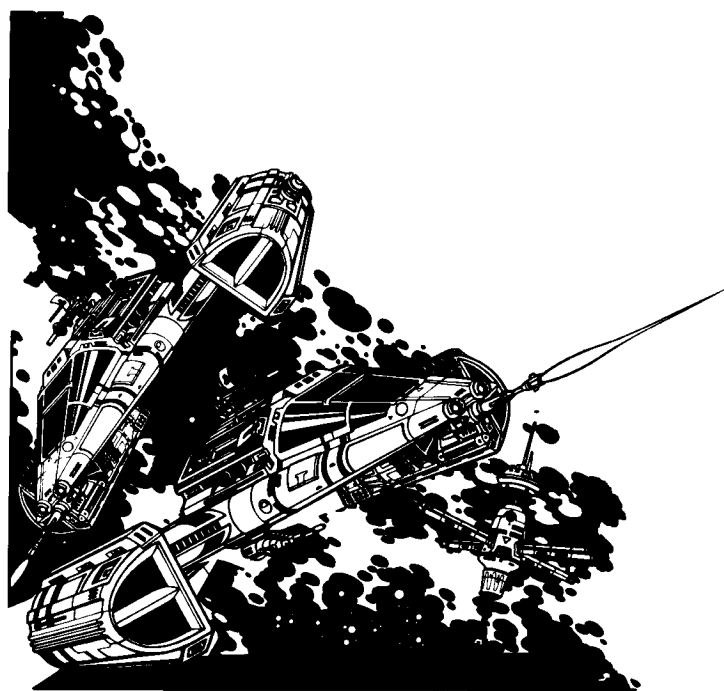

LATCH1

Active low software-generated signal from the vector-generator state machine ROM decoder H7. When **LATCH1** is low, data bits DVX3 through DVX11 are all set low at the outputs of shift registers A8, B8 and C8; data bits DVY0 through DVY7 are all set low at the outputs of shift registers F8 and J8; and data signals DVG0 through DVG3 are transferred to the DVY8 through DVY11 outputs of shift register H8 on the next rising edge of 12 MHz. OP0 through OP2 and DVY12 (from DVG4 through DVG7) are latched at the output of latch D6; and Z0 through Z2 and DVX12 are set low at the outputs of latch C6.

LATCH2

Active low software-generated signal from the vector-generator state machine ROM decoder H7. When **LATCH2** is low, data bits DVG3 through DVG7 are transferred to the DVX3 through DVX7 outputs of shift registers A8 and C8 on the next rising edge of 12 MHz.

LATCH3

Active low software-generated signal from the vector-generator state machine ROM decoder H7. When **LATCH3** is low, data bits DVG4 through DVG7 are transferred to the DVX8 through DVX11 outputs of shift register B8 on the next rising edge of 12 MHz. Latch C6, Z0 through Z2, and DVX12 from data bits DVG4 through DVG7 are latched at the output of latch C6.

NORM and $\overline{\text{NORM}}$

Active high software-generated signal from the normalization (NORM) flag latch A6. NORM is set

high and $\overline{\text{NORM}}$ is set low, when **STROBE0** goes high, if $\overline{\text{OP0}}$ is high and if CNTR, SCALE, and VCTR are all low. DVX11, DVX12, DVY11 and DVY12 must all be high or all low. When NORM goes high, the vector draw time of the vector-generator timer is divided by 2^n .

Each n divide is clocked by 12 MHz while $\overline{\text{NORM}}$ multiplies (shift left) the rate of change of the vector X and Y data in the vector data shifter at the same 2^n factor. The n number is incremented at the 12-MHz rate until either DVX11 or DVY11 changes state. When either goes high, NORM is cleared low, and $\overline{\text{NORM}}$ is set high by the high clear input of NORM latch A6.

OP0 and $\overline{\text{OP0}}$

Software-generated signals from vector-generator data-shifter latch D6. OP0 is latched active high and $\overline{\text{OP0}}$ is latched active low when **LATCH1** goes high, if vector-generator data bit DVG5 is high. Signals OP0 through OP2 are three of the eight address inputs to vector-generator state-machine ROM N4. These signals instruct the operation of the state machine. A high OP0 sets the HALT output of latch L5 high, when **STROBE3** goes from low to high. OP0 and OP2 are gated together, along with **STROBE3** and VGCK to set the vector (VCTR) flag output of latch E5. Vector flag VCTR will be valid only if OP0 and OP2 are both low. When **STROBE0** goes high, the normalization (NORM) flag is set low at the output of latch A6.

OP1 and $\overline{\text{OP1}}$

Software-generated signals from vector-generator data shifter latch D6. OP1 is latched active high and $\overline{\text{OP1}}$ is latched active low when **LATCH1** goes high, if vector-generator data bit DVG6 is high. Signals OP0 through OP2 are three of the eight address inputs to vector-generator state machine ROM N4. These signals instruct the operation of the state machine.

In the vector-generator timer, the low $\overline{\text{OP1}}$ signal input decreases the maximum count capabilities of the timer from 32K counts to 256 counts (a short vector) before causing a **STOP** timer output. The high OP1 signal enables a 1 to be loaded into the D input of counter P6 if NORM or $\overline{\text{NORM}}$ is low.

OP2 and $\overline{\text{OP2}}$

Software-generated signals from vector-generator data latch D6. OP2 is latched active high and $\overline{\text{OP2}}$ active low when **LATCH1** goes high, if vector-generator data bit DVG7 is high. Signals OP0 through OP2 are three of the eight address inputs to vector-generator state machine ROM N4. These signals instruct the operation of the state machine.

When OP2, OP0, **STROBE3** and VGCK are all low, VCTR goes high on the next falling edge of 12 MHz (beginning a vector trace) if **STOP** and **HALT** are



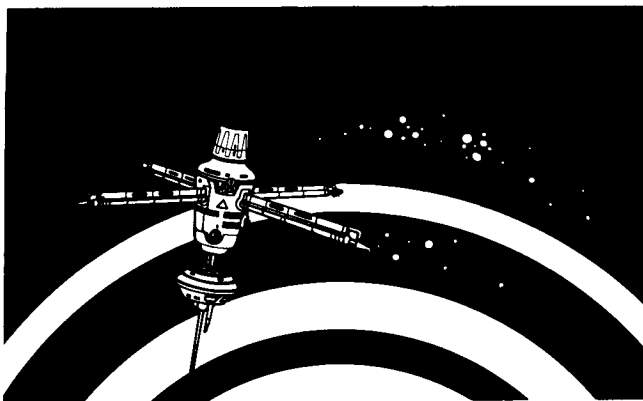

both high. When $\overline{\text{STOP}}$ goes low (vector timer has reached maximum count), $\overline{\text{VCTR}}$ goes low. If OP2 and $\overline{\text{OP2}}$ are active, CNTR goes high on the next falling edge of 12 MHz, if $\overline{\text{STROBE3}}$ is low and when $\overline{\text{VGCK}}$ goes low.

When $\overline{\text{STOP}}$ goes low, CNTR goes low on the next falling edge of 12 MHz. If OP2 and $\overline{\text{STROBE1}}$ are both low, latched data signals DVY8 through DVY10 (at the output of latch D7 in the vector-scaling circuit) are loaded into counter C7.

When $\overline{\text{STROBE1}}$ goes high, counter C7 counts down until it reaches the minimum count. At the same time, the timer circuit does a divide-by-2 (shift right) operation for each count of counter C7, caused by a valid SCALE input to the timer. When C7 reaches its minimum count, its minimum/maximum (M/M) output goes high, causing SCALE to go low.

If OP2 , $\overline{\text{STROBE2}}$, and $\overline{\text{DVY12}}$ are low, new scaling data (DVY8 through DVY10) is latched at the output of vector-scaling circuit latch D7. If DVY12 is low, Z-axis data signals DVY4 through DVY7 are latched at the output of latch E6 in the Z-axis output circuit.

OUTPUT

Active low software-generated signal from microprocessor address decoder L4 at address 0C00. When low, the microprocessor outputs to the coin-door coin counters, control-panel LEDs and the X and Y axis invert circuits on buffered data bits DB0 through DB7 .

POR

Hardware-generated signal in the power-on reset circuit that is low when voltage at plus input is less than about 7 volts. This also protects the microprocessor against glitches on the power line input. It is assumed that if the 10.3V input has a glitch on it, then the +5V input to the game PCB will also have a glitch.

RAM0

Active low software-generated signal from microprocessor address decoder P3 at addresses 0000 through 03FF. This signal enables RAMs E1 and H1.

RESET

Hardware-generated signal from watchdog circuitry or the power-on reset circuitry. The power-on reset circuitry causes this signal to be low while the voltages of the power-supply input are reaching their regulated levels, guaranteeing that the address lines of the microprocessor are stabilized before letting the microprocessor do its thing. The watchdog circuitry causes $\overline{\text{RESET}}$ to go low if the microprocessor fails to output address 0D00 before the watchdog counter H4 reaches its maximum count.

ROM

Active low software-generated signal from microprocessor address decoder R2 at addresses 4000 through FFFF. This signal enables ROM data buffer E2 and bidirectional buffer F2 for the microprocessor to read data from the ROMs.

ROM0

Active low software-generated signal from microprocessor address decoder R2 at addresses 4000 through 4FFF. This signal selects microprocessor program memory ROM R1.

ROM1

Active low software-generated signal from microprocessor address decoder R2 at addresses 5000 through 5FFF. This signal selects microprocessor program memory ROM N/P1.

ROM2

Active low software-generated signal from microprocessor address decoder R2 at addresses 6000 through 6FFF. This signal selects microprocessor program memory ROM M1.

ROM3

Active low software-generated signal from microprocessor address decoder R2 at addresses 7000 through 7FFF. This signal selects microprocessor program memory ROM K/L1.

ROM4

Active low software-generated signal from inverted microprocessor address line A15 at addresses 8000 through FFFF. This signal selects microprocessor program memory ROM J1.

$\overline{\text{R/WB}}$

Active low software-generated signal from the microprocessor, $\overline{\text{R/W}}$ output, buffered by B1 and inverted by F3. When this signal is low, decoder K6 of the microprocessor address decoder is enabled from the microprocessor to do the following: read data from EAROM M2 (in the high-score table circuit) on data lines DB0 through DB7 ; read switch data on data lines DB0 through DB7 through the buffer M9; or read switch data on data lines DB6 and DB7 from multiplexers L9 and N9.

SAEN

Unused test point.

SCALE

Hardware-generated signal activated by software from the vector-scaling circuit. SCALE is active high when OP2 is high and counter C7 is counting down (at a 12 MHz rate) from the number loaded into counter C7 from the output of scale latch D7. SCALE stays high until counter C7 reaches the 0 count. For each count of counter C7, the vector timer does a load operation at the same 12-MHz rate. The result is a divide of the vector draw time by a factor of 2^n . The value of n is equal to the total counts of C7.

SCALELD

Software-generated signal that is active low when STROBE2, OP2 and DVY12 are all low. Scale data bits DVY8 through DVY10 are latched at the outputs of latch D7 when SCALELD goes high.

STATCLK

Software-generated signal that is active low when STROBE2, OP2 and DVY12 are all low. Color data bits DVY0 through DVY2 are latched at the outputs of latch K10 when STATCLK goes high. STATCLK also latches Z data bits DVY4 through DVY7 at the output of Z-axis latch E6 when STATCLK goes high.

STOP

Hardware-generated signal from the vector timer. When STOP goes low, the vector timer has reached its maximum count. The low STOP causes the VCTR and CNTR flags to be set low on the next falling edge of 12 MHz.

STROBE0

Active low software-generated signal from the vector-generator state machine ROM decoder H7. When STROBE0 goes from a low to a high, the state of OP0 is transferred to the output of latch A6. If OP0 is low, NORM will go low. If OP0 is high and CNTR, SCALE, VCTR, DVX11, DVX12, DVY11 and DVY12 are all low, NORM goes high when STROBE0 goes from low to high.

STROBE1

Active low software-generated signal from the vector-generator state machine ROM decoder H7. When STROBE1 goes low and if OP2 is low, scaling bits latched at the outputs of latch D7 are loaded into counter C7. When STROBE1 goes high, counter C7 begins counting down at a 12-MHz rate from the loaded count input. As the counter counts, the minimum/maximum (M/M) output of the counter is low, resulting in a high SCALE signal input to the vector timer. When the count of C7 reaches zero, the M/M output of the counter goes high, making SCALE low.

STROBE2

Active low software-generated signal from the vector-generator state machine ROM decoder H7. When STROBE2 and OP2 are both low and DVY12 is low, STATCLK goes low. If DVY12 is high, SCALELD goes low.

STROBE3

Active low software-generated signal from the vector-generator state machine ROM decoder H7. When STROBE3 is low, VCTR is set high, OP0 and OP2 are low on the falling edge of VGCK, delayed by falling edge of 12 MHz. In addition, CNTR is set high, if OP2 is high on the falling edge of VGCK, delayed by falling edge of 12 MHz. If OP0 is high, HALT goes high when STROBE3 goes from a low to a high.

ST0 through ST2

Software-generated instructions from vector-generator state machine ROM N4. These signal outputs from the ROM are decoded for the LATCH0 through LATCH 3 and STROBE0 through STROBE3 outputs of decoder H7. ST0 through ST2, plus the highest data bit output from the ROM, are latched at the output of latch R4 for the four lowest-bit inputs of ROM N4.

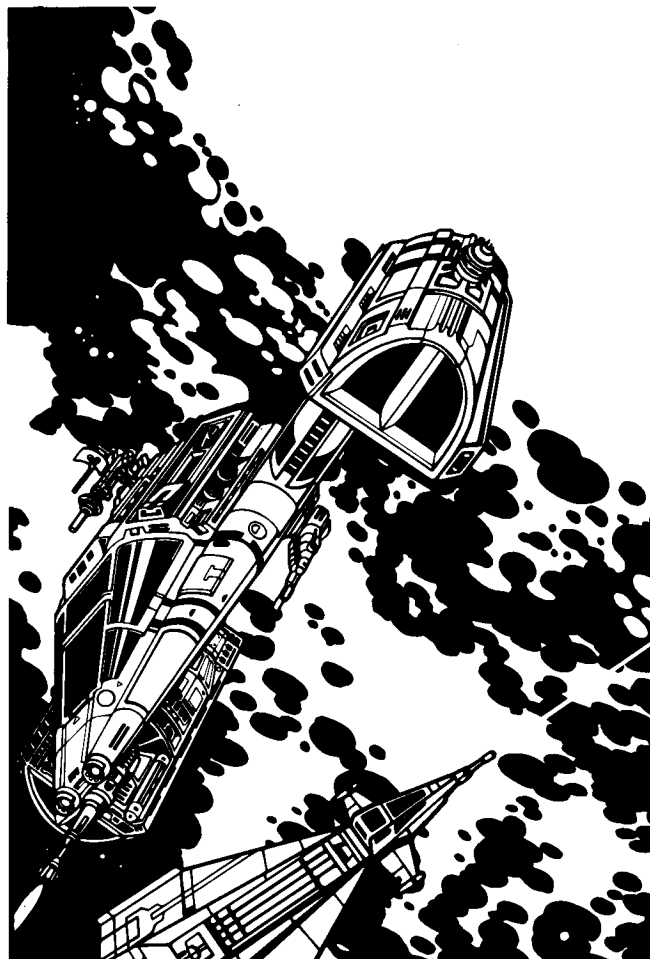

ST3

Hardware-generated signal from the output of state machine control flip-flop A7. This signal is the inverted state of VGCK (1.5 MHz), delayed by one pulse of 12 MHz, if the most-significant-bit output of state machine ROM N4 is low and $\overline{\text{VMEM}}$ is high. If the output bit of ROM N4 is high, ST3 is high. When ST3 is low, one of eight outputs of state machine decoder H7 are selected by ST0 through ST2. When ST3 is high, all outputs of decoder H7 are disabled.

VCTR

Software-generated signal from the VCTR flag. When $\overline{\text{HALT}}$ from the halt flag is low, VCTR is set low and $\overline{\text{VCTR}}$ is set high and remains high until $\overline{\text{HALT}}$ goes high. When OP0, OP2, $\overline{\text{STROBE3}}$ and VGCK are all low, VCTR goes high on the next falling edge of 12 MHz. When VCTR is high, NORM is set low with a low clear input to NORM flag A6.

A high VCTR causes the vector timer to do the following: start its draw time counter with a high GO input; latch the Z-axis intensity data at the outputs of latch H6; and enable X- and Y-axis digital-to-analog converters A/B9 and F9 for drawing the vector. When $\overline{\text{STOP}}$ is received at the input of the VCTR flag, VCTR is set low and $\overline{\text{VCTR}}$ is set high.

VGCK

Hardware-generated signal that is 1.5 MHz passed through buffer B1. This is the basic timing signal of the vector generator that clocks state machine latch R4.

 $\overline{\text{VGG0}}$

Software-generated decode from microcomputer address decoder L4 at address 0C80 that sets $\overline{\text{HALT}}$ of the halt flag low.

 $\overline{\text{VGRST}}$

Software-generated signal from the address decoder at address 0D80 that is ORed together with $\overline{\text{RESET}}$ to produce $\overline{\text{DISRST}}$.

 $\overline{\text{VMEM}}$

Software-generated signal from the microcomputer address decoder, from addresses 2000 through 3FFF. This signal, when low, selects the microprocessor addresses through address-selector multiplexers K8, L8, M8 and N8. This signal is also conditioned by flip-flops L5 and A7 and by various gates to disable state machine decoder H7 with a high ST3 input. This signal kills the clock of state machine latch R4 of the vector generator.

 $\overline{\text{VRAM0}}$

Active low software-generated signal from vector-generator address decoder K6 at address locations 2000 through 23FF. When low, RAMs K7 and M7 are enabled.

 $\overline{\text{VRAM1}}$

Active low software-generated signal from vector-generator address decoder K6 at address locations 2400 through 27FF. When low, RAMs J7 and L7 are enabled.

 $\overline{\text{VROM1}}$

Active low software-generated signal from vector-generator address decoder K6 at address locations 2800 through 2FFF. When $\overline{\text{VROM1}}$ is low, vector ROM R7 is enabled.

 $\overline{\text{VROM2}}$

Active low software-generated signal from address controller J9 and inverted by inverter K9 at address locations 3000 through 3FFF. When low, ROM N/P7 is enabled.

 $\overline{\text{VW}}$

Software-generated signal from vector-generator address selector multiplexer K8. When $\overline{\text{VMEM}}$ is low, $\overline{\text{VW}}$ is from the microprocessor $\overline{\text{R/WB}}$. When $\overline{\text{VMEM}}$ is high, this signal is held high by pull-up resistor R83. When $\overline{\text{VW}}$ is low, data is written to the vector RAM from the microprocessor. When $\overline{\text{VW}}$ is high, data may be read from the vector RAM.

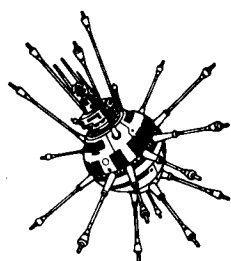

WDDIS

Test point in the microprocessor watchdog circuit that, when grounded, prevents **RESET** from going low (except when **RESET** button is pressed).

Z0 through Z2

Software-generated signals from vector-generator data shifter latch C6. **Z0** is latched active high in the vector data shifter, if data bit **DVG5** is high when **LATCH3** goes low. **Z1** is latched active high and **Z1** is latched active low, if data bit **DVG6** is high when **LATCH3** goes low. **Z2** is latched active high and **Z2** is latched active low, if data bit **DVG7** is high when **LATCH3** goes low. These signals are the Z-axis inputs to the Z-axis digital-to-analog converter if they are less than or greater than the binary count 1. When the **VCTR** signal goes high, these Z-intensity bits are latched at the output of latch H6.

If the count at the output of the latch is zero, the conditions are met with the all-high inputs of NAND gate H5 for a high **ZBLANK** signal to the video display, turning the video display beam off. If the count is greater than one, the binary count determines the bias of transistor Q7, resulting in one of six possible Z-axis level outputs to the video display.

If the Z count is 1, the conditions are met with all high inputs to AND gate F5 for a high **S** (select) input to multiplexer F6. This results in selecting the Z data latched directly from data bits **DVY4** through **DVY7** when **STATCLK** goes low. In this case, the one of sixteen binary count determines the bias of transistor Q7.

**3KHz**

Hardware-generated signal from the clock circuitry read by the microprocessor through the coin door and control-panel input circuits on data line **DB6** through switch input buffer M9 when **SINP1** is low. This frequency is used by the microprocessor as its time reference.

3MHz

Hardware-generated signal from the clock circuit. This is one of the conditioning signals in the vector state machine control circuitry for delaying the time when **VMEM** kills the state machine clock and disables the state machine decoder.

6MHz

Hardware-generated signal from the clock circuitry. This is one of the conditioning signals in the vector state machine control circuitry for delaying the time when **VMEM** kills the state machine clock and disables the state machine decoder.

12KHz

Hardware-generated signal from the clock circuitry. The signal is used to clock timer A4 of the high-score table circuit.

12MHz

Hardware-generated signal from the clock circuitry. This is the basic timing that determines the resolution of the vector generator.

Φ0

Hardware-generated signal used for the clock of microprocessor C2; this signal is equal to 1.5 MHz.

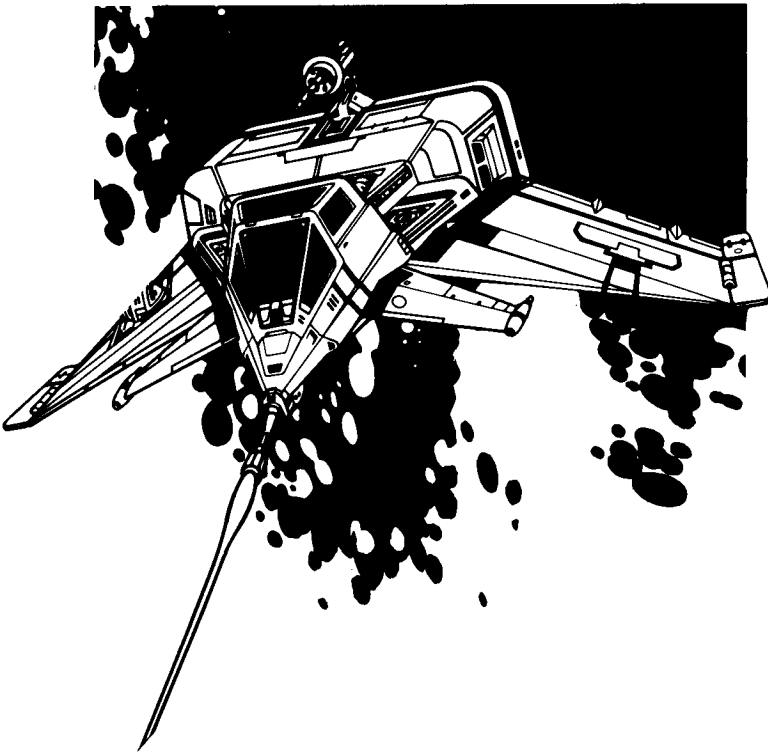

Maintenance, Repair and Parts

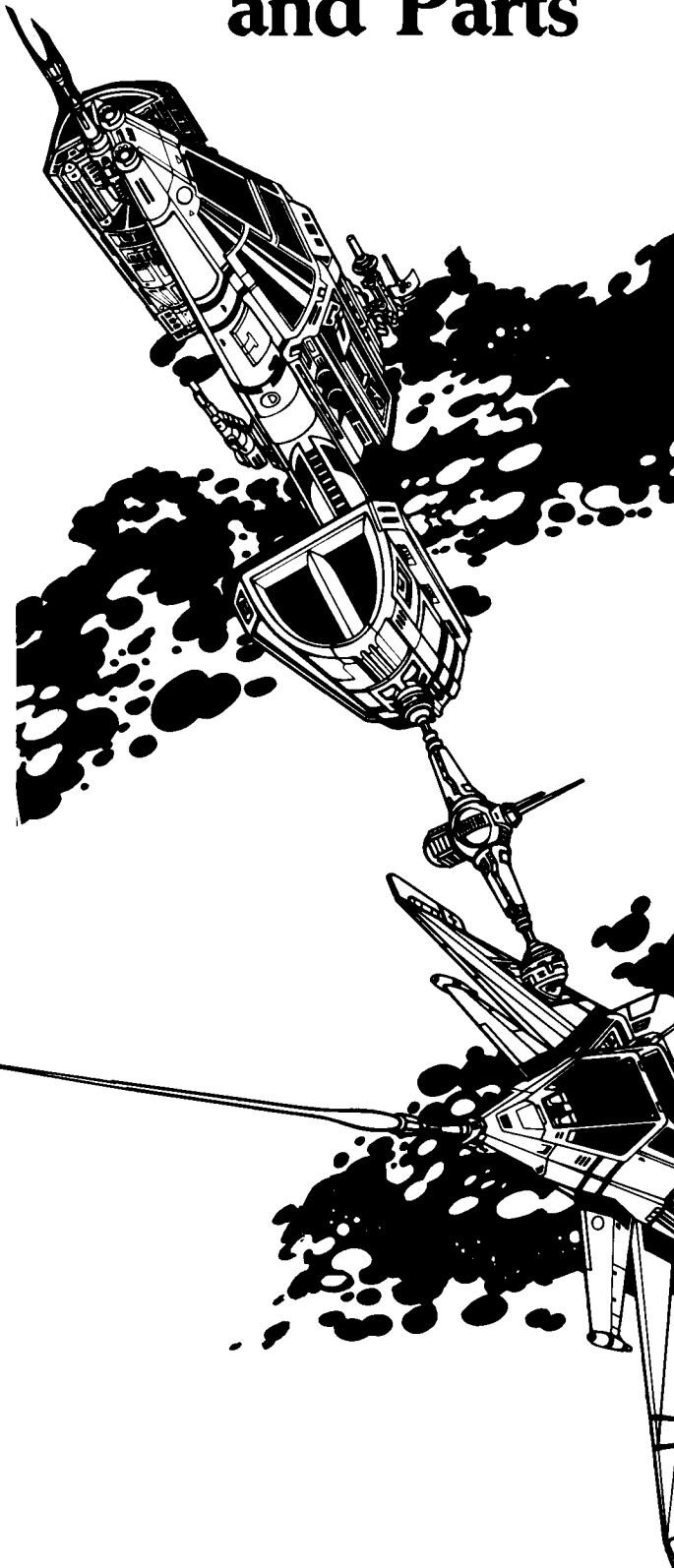

In addition to maintenance and repair information, this chapter provides the necessary information for you to order parts for your Space Duel™ Upright and Cocktail games. Please note that, for simplicity, **common hardware has been deleted** from most of the parts lists. This includes screws, nuts, washers, bolts, etc.

The parts lists are arranged in alphanumeric order. For example, all "A-" prefix numbers come first. Following this are numbers in sequence evaluated up to the hyphen, namely 00- thru 99-, then 000598- thru approximately 190000-.

When ordering parts, please give the part number, part name, applicable figure number of this manual, and serial number of your game. This will help to avoid confusion and mistakes in your order. We hope the results will be less downtime and more profit from your game.

Atari Customer Service numbers are listed in the front of this manual for your convenience.

Chapter

3

Schematics, Self-Test Label & Manuals—
see parts list on following page

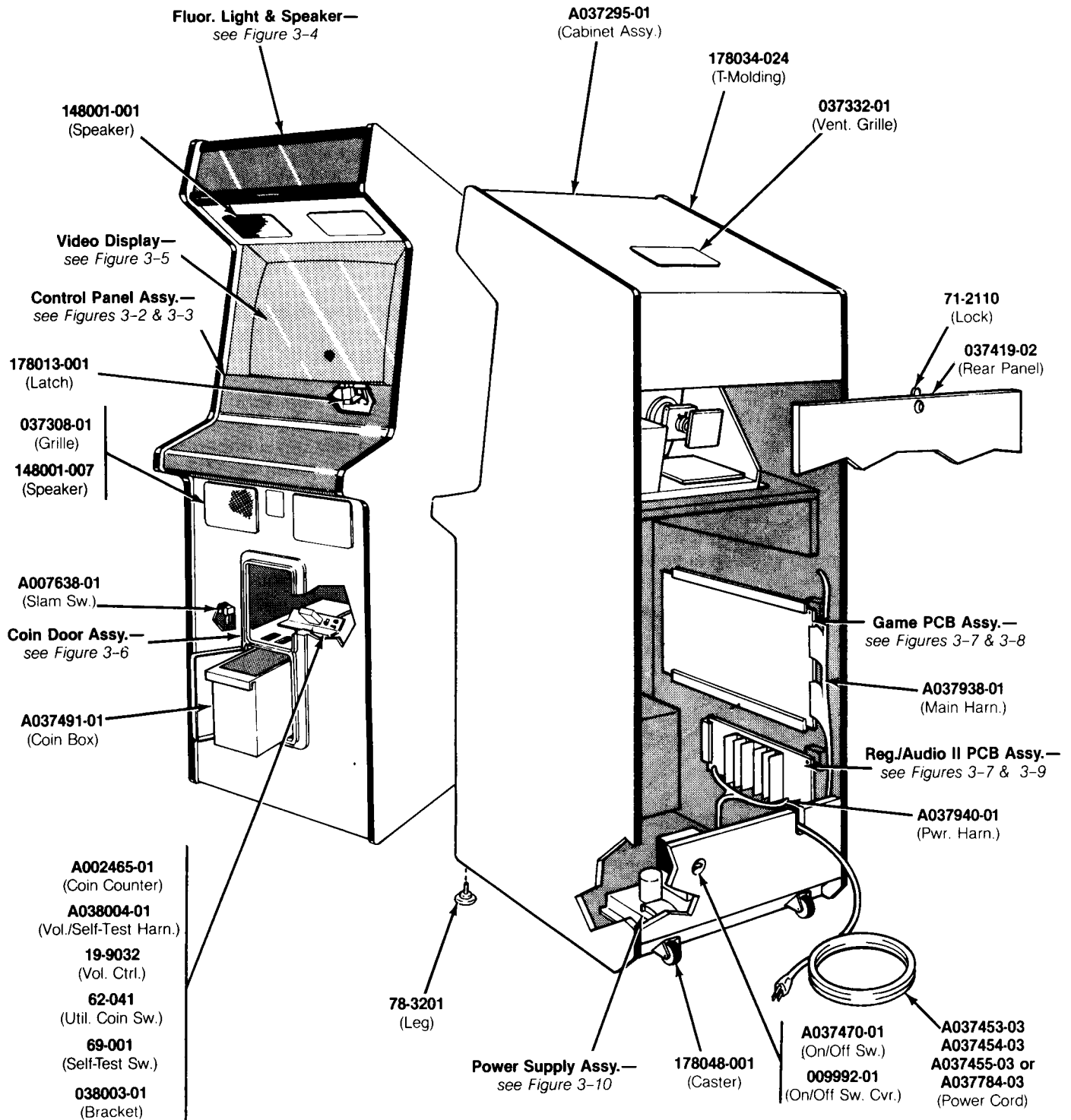

Figure 3-1 Upright Cabinet-Mounted Assemblies
A037294-xx B

Figure 3-1, continued Upright Cabinet-Mounted Assemblies Parts List

<i>Part No.</i>	<i>Description</i>
A002465-01	Coin Counter
A007638-01	Slam Switch Assembly
A037295-01	Cabinet Assembly <i>(includes legs and PCB retainers, but not the rear access panel)</i>
A037453-03	Strain-Relief Power Cord <i>(U.S. and Canada)</i>
A037454-03	Strain-Relief Power Cord <i>(Austria, Belgium, Chile, Denmark, Finland, France, Germany, Greece, Indonesia, Italy, Netherlands, Norway, Spain, Sweden, and Uruguay)</i>
A037455-03	Strain-Relief Power Cord <i>(Australia and New Zealand)</i>
A037470-01	Power On/Off Switch/Mounting Plate Assembly
A037491-01	Coin Box
A037784-03	Strain-Relief Power Cord Assembly <i>(United Kingdom, Ireland, Lebanon, Saudi Arabia, India, Hong Kong, Singapore, Egypt, Nigeria, Republic of South Africa, Zimbabwe)</i>
A038004-01	Harness for Volume Control/Self-Test Switch/Coin Counter Assembly
A037938-01	Main Harness Assembly
A037940-01	Power Harness Assembly
<i>The following four items are the technical information supplements to this game:</i>	
SP-181	Space Duel™ Schematic Package
ST-181-01	Space Duel Label with Self-Test Procedure and Option Switch Settings
TM-181	Space Duel Operation, Maintenance and Service Manual
TM-183	Service Manual for 19-Inch Wells Gardner Color X-Y Display
19-9032	Volume Control
62-041	SPDT Momentary-Contact Pushbutton Utility Coin Switch with Black Cap
69-001	DPDT Self-Test Switch
71-2110	Panel Cartridge Lock Mechanism <i>(for rear access panel)</i>
78-3201	Cabinet-Leveling Leg
009992-01	On/Off Switch Cover
036686-01	Card of Game Pricing Labels <i>(not shown in illustration)</i>
037308-01	Speaker Grille
037331-01	Side Panel Decal <i>(For Ireland build only. Not shown in illustration)</i>
037332-01	Ventilation Grille <i>(located on cabinet top)</i>
037419-02	Rear Access Panel <i>(does not include lock)</i>
038003-01	Bracket for Volume Control, Self-Test Switch and Coin Counter(s)
148001-001	6 × 9-Inch 4-Ohm 15W Oval High-Fidelity Speaker <i>(For upper cabinet)</i>
148001-007	6 × 9-Inch 4-Ohm 15W Oval High-Fidelity Speaker <i>(For lower cabinet)</i>
178013-001	Spring Draw Latch
178034-024	¾-Inch Black Plastic T-Molding
178048-001	Rigid Caster

Schematics, Self-Test Label & Manuals—
see parts list on following page

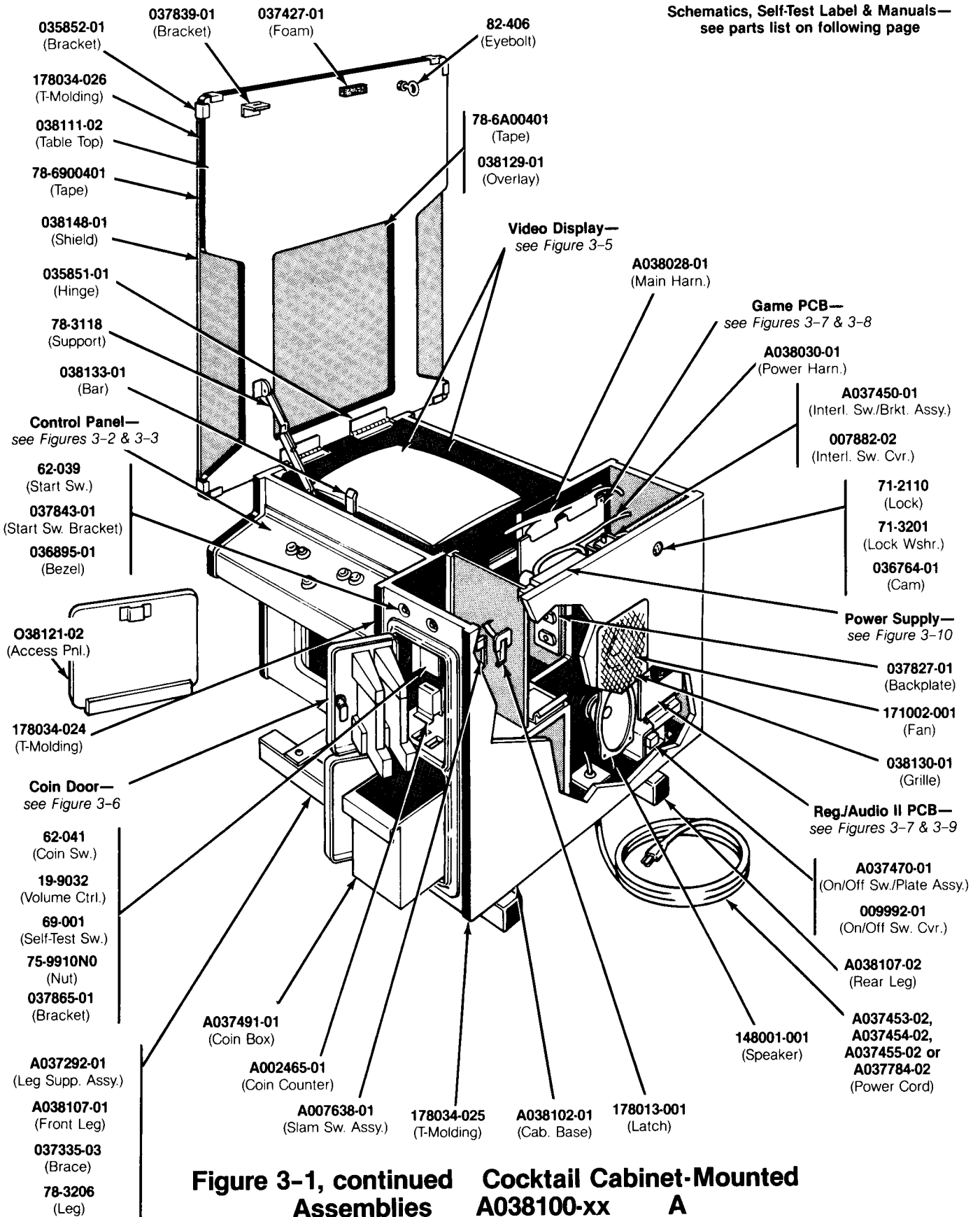

Figure 3-1, continued Cocktail Cabinet-Mounted Assemblies A038100-xx A

Figure 3-1, continued Cocktail Cabinet-Mounted Assemblies Parts List

Part No.	Description
A002465-01	Coin Counter
A007638-01	Slam Switch Assembly
A037292-01	Leg Support Assembly <i>(includes endcap)</i>
A037450-01	Interlock Switch/Bracket Assembly
A037453-02	Strain-Relief Power Cord <i>(U.S. and Canada)</i>
A037454-02	Strain-Relief Power Cord <i>(Austria, Belgium, Chile, Denmark, Finland, France, Germany, Greece, Indonesia, Italy, Netherlands, Norway, Spain, Sweden, and Uruguay)</i>
A037455-02	Strain-Relief Power Cord <i>(Australia and New Zealand)</i>
A037470-01	Power On/Off Switch/Mounting Plate Assembly
A037491-01	Coin Box
A037784-02	Strain-Relief Power Cord Assembly <i>(United Kingdom, Ireland, Lebanon, Saudi Arabia, India, Hong Kong, Singapore, Egypt, Nigeria, Republic of South Africa, Zimbabwe)</i>
A038028-01	Main Harness Assembly
A038030-01	Power Harness Assembly
A038102-01	Cabinet Base Assembly <i>(includes leg backplates, PCB retainers, and access panel)</i>
A038107-01	Front Leg Assembly <i>(includes leg, 2 adjustable feet and 2 endcaps)</i>
A038107-02	Rear Leg Assembly <i>(includes leg, 2 adjustable feet and 2 endcaps)</i>
<i>The following four items are the technical information supplements to this game:</i>	
SP-181	Space Duel™ Schematic Package
ST-181-02	Space Duel/Cocktail Label with Self-Test Procedure and Option Switch Settings
TM-181	Space Duel Operation, Maintenance and Service Manual
TM-183	Service Manual for 19-Inch Wells Gardner Color X-Y Display
19-9032	50 Ohm, 12½W Wire-Wound Rheostat <i>(for volume control)</i>
62-039	SPDT Momentary-Contact LED Start Switch
62-041	SPDT Momentary-Contact Pushbutton Utility Coin Switch
69-001	DPDT Self-Test Switch
71-2110	Panel Cartridge Lock Mechanism <i>(for table top)</i>
71-3201	¾-Inch Anchor Washer for Table-Top Lock
75-9910N0	#⅝-11 Steel Stamped Nut <i>(for utility coin switch)</i>
78-3118	Hinged Table-Top Support
78-3206	Cabinet-Leveling Leg
78-6A00401	Vinyl Foam Double-Coated-Adhesive Tape ¼-inch wide x ⅙-inch thick <i>(22 in. required)</i>
78-6900401	Vinyl Foam Single-Coated-Adhesive Tape ¼-inch wide x ⅙-inch thick <i>(12 feet required)</i>
82-406	#¼-20 × 2-Inch Eyebolt with ¾-Inch Threads
007882-02	Interlock Switch Cover
009992-01	On/Off Switch Cover
035851-01	Table-Top Hinge
035852-01	Corner Bracket for Table Top
036764-01	Hook-Type Cam <i>(for table-top lock)</i>
036895-01	Black Molded Switch Bezel
037335-03	Leg Brace
037427-01	Foam Vibration Damper <i>(for table top)</i>
037827-01	Leg Backplate
037839-01	Spring Draw Latch Bracket
037843-01	Start Switch Mounting Bracket
037865-01	Bracket for Volume Control, Self-Test Switch and Coin Counter

[Continued on next page]

Figure 3-1, continued Cocktail Cabinet-Mounted Assemblies Parts List

<i>Part No.</i>	<i>Description</i>
038111-02	Wood Table Top
038121-02	Access Panel
038129-01	Video Display Overlay
038130-01	Speaker/Fan Grille
038133-01	Security Bar
038148-01	Display Shield with Graphics
148001-001	6 × 9-Inch, 4-Ohm, 15W Oval High-Fidelity Speaker
171002-001	110V Cooling Fan
178013-001	Spring Draw Latch
178034-024	$\frac{3}{4}$ -Inch Black Plastic T-Molding <i>(for center cabinet base)</i>
178034-025	$\frac{25}{32}$ -Inch Black Plastic T-Molding <i>(for cabinet ends)</i>
178034-026	$\frac{1}{16}$ -Inch Black Plastic T-Molding <i>(for table top)</i>

WARNING

Prior to removing or repairing any printed-circuit board, **unplug the game.**

To Open the Control Panel:

1. To open the control panel on the *Upright game*, open the coin door. Reach up through the opening to the top of the control panel. Open the spring-draw latches. Close the coin door. Lift up on the control panel at the top-most edge and tilt it toward you.
2. The control panel edge next to the display shield has foam tape applied to it. This tape acts as a cushion for the glass and prevents spilled liquids from entering the cabinet interior. Always make sure this tape is in good condition.
3. To open the control panel on the *Cocktail game*, remove the Allen-head screws. Then, tilt the control panel toward you.

Leaf Switch Repair:

- Adjust the leaf switches for a narrow gap. When a switch button is depressed, the resulting wiping action of the cross-bar contacts provides a self-cleaning feature. **Don't burnish the contacts.** To clean them, use electrical contact cleaner.
- To replace a leaf switch, remove the screw with a Phillips-head screwdriver.
- To replace the switch button, turn the stamped nut with a wrench in a counterclockwise direction, as seen from the inside of the control panel. The ring on the outside of the control panel should not spin, due to its design.
- To reinstall a switch, reconnect the harness wires as shown in the *Schematic Package, Game Wiring Diagram*. Make certain the right colors go to the right tabs on the switch.

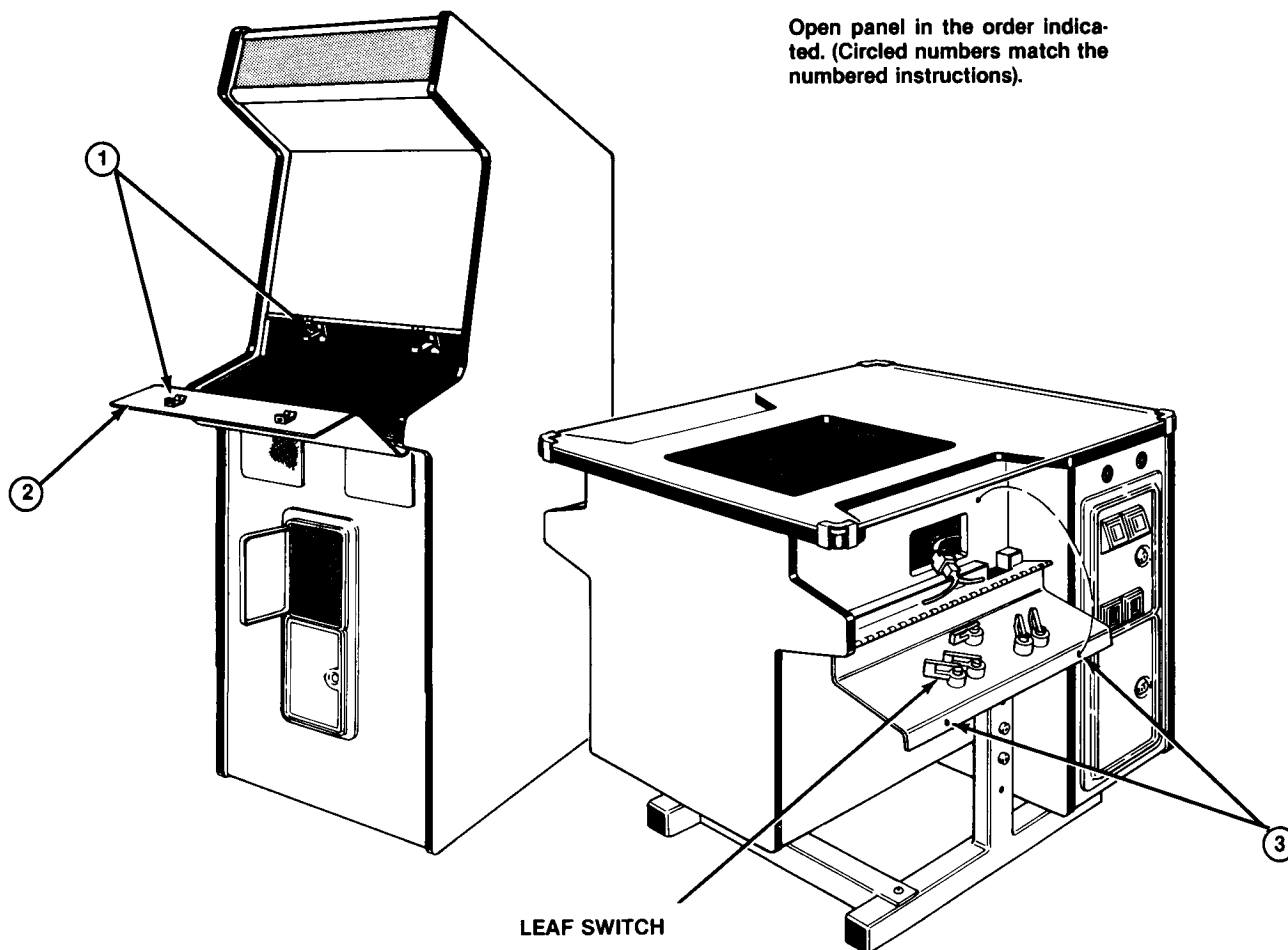

Figure 3-2 The Control Panel

LED Start- and Select-Switch Repair:

The LED switches have a very low failure rate. In case a switch should ever be suspect, first test it per the description that follows.

To Test LED Switch:

- Remove the wires from the suspected switch.
- Attach the leads of an ohmmeter to normally open and common contacts.
- Check contacts (push and release the switch button) for closed and open continuity.

- If the contacts do not operate sharply or always remain closed or open, then replace the LED switch.

To Replace LED Switch:

- Remove all wires from the faulty switch.
- Turn the switch counterclockwise while holding the black cone-shaped bushing on the outside of the control panel.
- Install a new switch using the reverse procedure.
- Reconnect the harness wires as shown.

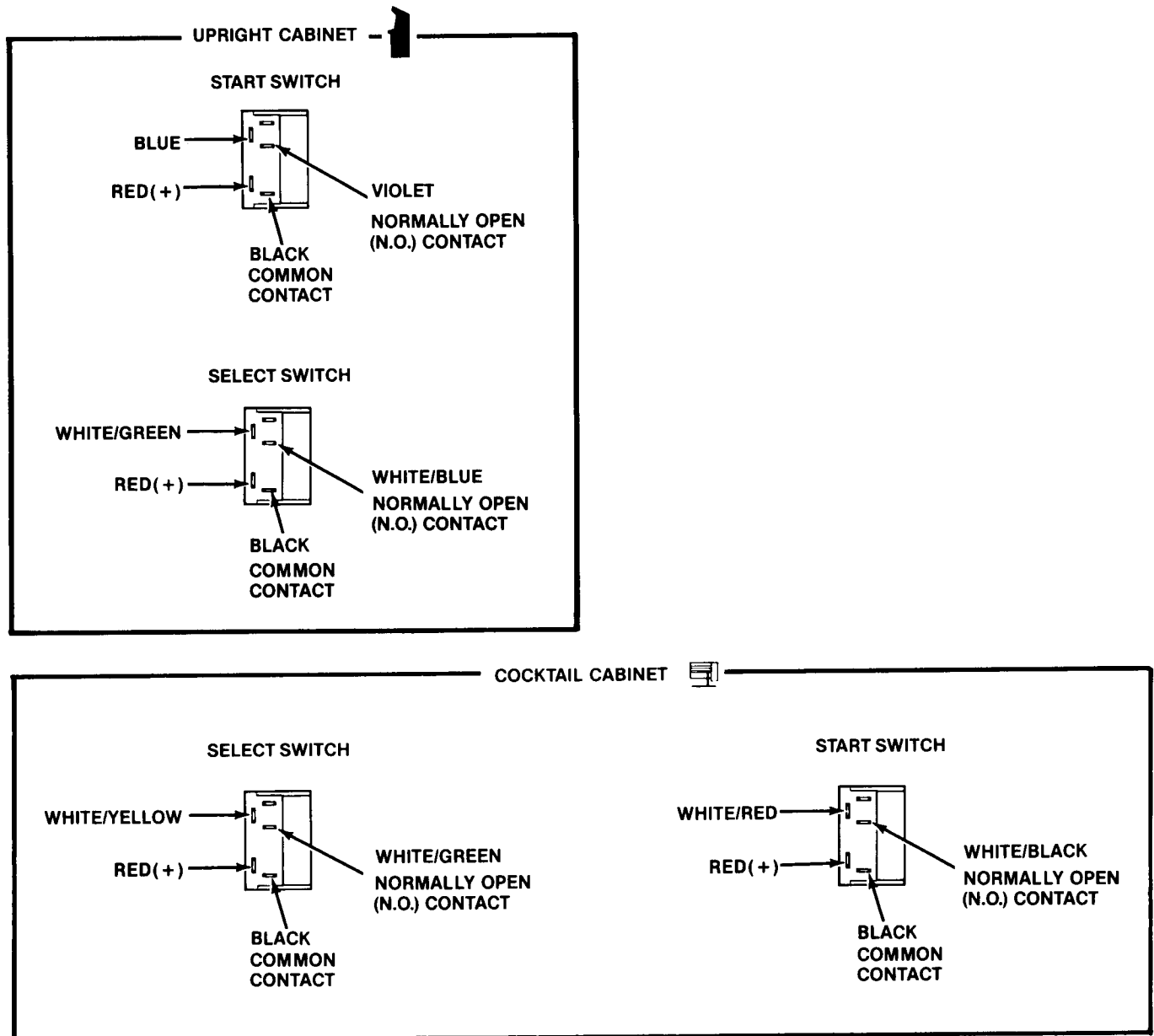
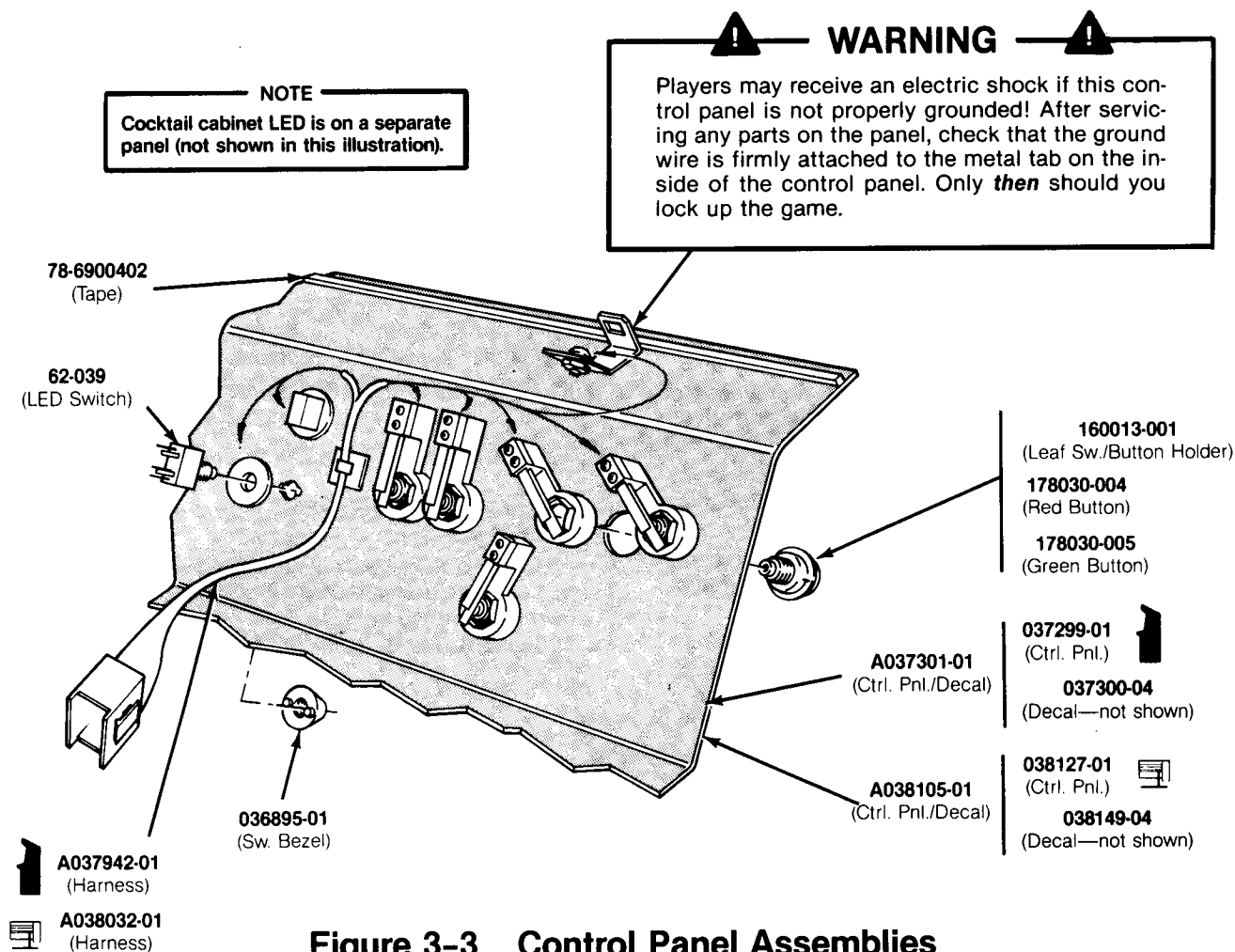

Figure 3-2 The Control Panel, continued



**Figure 3-3 Control Panel Assemblies
Upright A037302-01 A and Cocktail A038104-xx A**

Parts List

Part No.	Description
A037301-01	Upright Control Panel with Decal
A037942-01	Upright Control Panel Harness Assembly
A038032-01	Cocktail Control Panel Harness Assembly
A038105-01	Cocktail Control Panel with Decal
62-039	SPDT Momentary Pushbutton Start Switch, with Red Light-Emitting Diode
78-6900402	Vinyl Foam Single-Coated-Adhesive Tape, ¼-inch wide × ⅛-inch thick (24 in. required)
036895-01	Black Molded Switch Bezel
037299-01	Upright Control Panel
037300-04	Upright Control Panel Decal
038127-01	Cocktail Control Panel
038149-04	Cocktail Control Panel Decal
160013-001	Leaf Switch and Button Holder (leaf switch only is part no. 160012-001)
178030-004	Red Pushbutton Assembly
178030-005	Green Pushbutton Assembly

WARNING

Prior to removing or repairing the speaker, fluorescent tube or fan, **unplug the game.**

If you drop a fluorescent tube and it breaks, *it will implode!* Shattered glass can fly 6 feet or more from the implosion. Use care when replacing any fluorescent tube.

To Replace Fluorescent Tube:

1. At the top front of the game, remove the three sets of hardware that secure the upper attraction-panel retainer to the cabinet. *Loosen* the three sets of hardware that secure the lower retainer to the cabinet. Lift the attraction panel up and out of its lower retainer.
2. Remove the cardboard locking tab at each end of the tube. Slightly rotate the tube up or down, and carefully remove it from the lampholders.
3. Replace with a new tube. Do not snap the tube in vigorously—you may break it, causing an implosion! Replace the locking tabs.
4. Check that the green ground wire is securely attached to the large metal bracket and the ballast transformer on the wood panel. If the tube is not grounded, it may not start.

To Replace Upright Cabinet Speakers:

5. Upper speakers—from the back of the cabinet, unplug the 5-pin harness connector just behind the speaker board. From the front of the cabinet, remove the screws that secure the light board to the cabinet. Slide the board out of the cabinet.
 6. Unplug the two plug-in connectors on the speaker. Remove the hardware that attaches the speaker to the board. Replace the speaker, re-install the wood board and reconnect the harness.
- Lower speakers—unplug the two plug-in connectors on the speaker. Remove the hardware that attaches the speaker to the cabinet. Install the new speaker, and replace the hardware and connectors.

To Replace Cocktail Speaker and Fan:

WARNING

Unplug the game and unlock and open the table top. Let the Regulator/Audio II PCB heat sink cool down for about 10 minutes.

To remove the speaker or fan, unplug the wire connectors. Use a short-handled Phillips screwdriver to remove the screws that attach the speaker or the fan to the cabinet wall. Repair or replace the speaker or fan as required. Make sure the green ground wire is securely attached when replacing the fan.

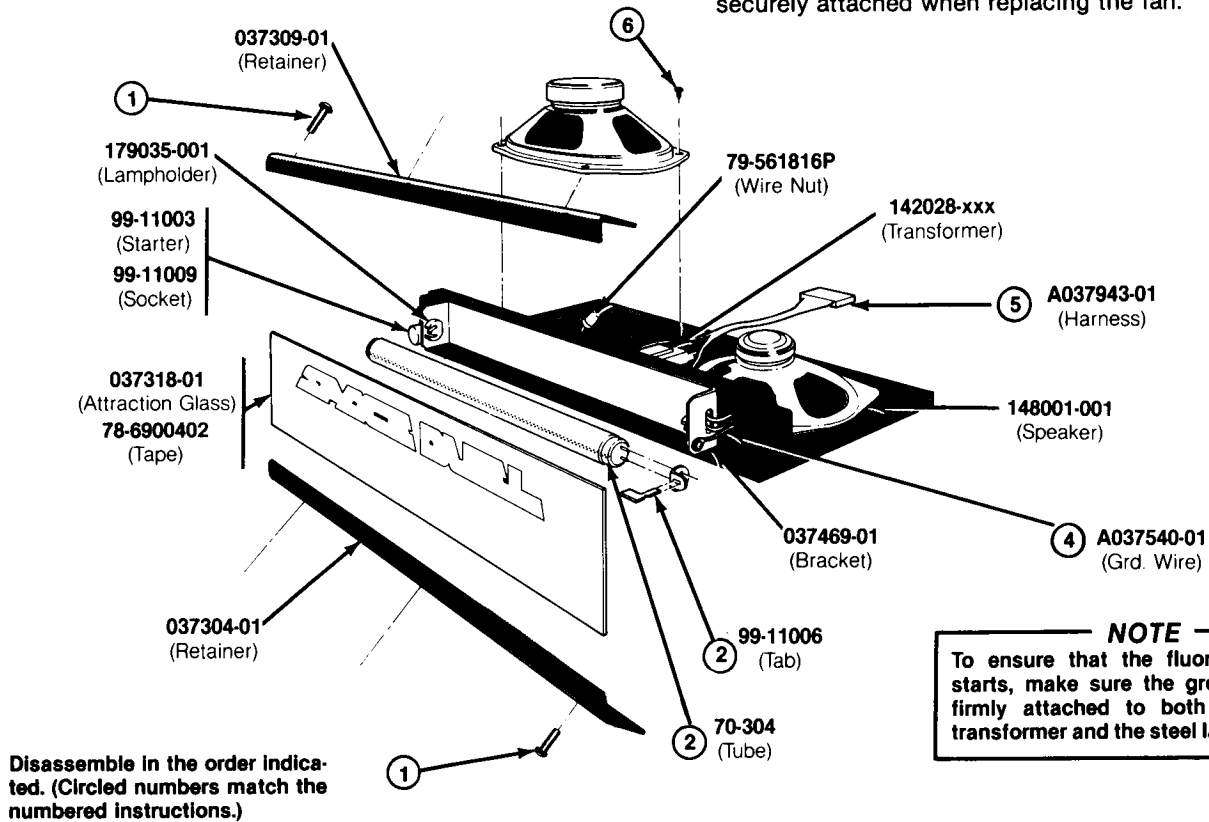

NOTE

To ensure that the fluorescent tube starts, make sure the ground wire is firmly attached to both the ballast transformer and the steel lamp bracket.

Figure 3-4 Speaker, Fluorescent Tube and Fan

Figure 3-4 Speaker, Fluorescent Tube and Fan, continued A037319-01 & -02 A

Parts List

<i>Part No.</i>	<i>Description</i>
A037540-01	Ground Wire with Ring Lug
A037943-01	Light and Speaker Harness
70-304	18-Inch 15-Watt Cool White Fluorescent Tube
78-6900402	Vinyl Foam Single-Coated Adhesive Tape <i>(48 in. required)</i>
79-561816P	Spring-Connector Wire Nut for 16- to 18-Gauge Wires
99-11003	Fluorescent Lamp Starter
99-11006	Fluorescent Lamp Locking Tab <i>(tab consists of two pieces)</i>
99-11009	Starter Socket
037304-01	Bottom Attraction Glass Retainer
037309-01	Top Attraction Glass Retainer
037318-01	Attraction Glass with Graphics
037469-01	Steel Lamp Bracket
142028-001	60-Hz 118-Volt Ballast Transformer <i>(used on A037319-01 assembly)</i>
142028-002	50-Hz 118-Volt Ballast Transformer <i>(used on A037319-02 assembly)</i>
148001-001	6 x 9-Inch 4-Ohm 15-Watt Oval High-Fidelity Speaker
171002-001	110V Cocktail Cooling Fan <i>(not shown in illustration)</i> 
179035-001	2-Pin Fluorescent Lampholder

WARNING:
Shock Hazard

The following procedure should only be performed by a *qualified service technician*. Prior to removing or repairing the video display, **unplug the game**. As an extra precaution, we highly recommend you *discharge the high voltage* from the picture tube.

High voltages may exist in any video display, even with power disconnected. Use extreme caution and do not touch electrical parts of the display yoke area with your hands or with metal objects in your hands!

Implosion Hazard

If you drop the display and the picture tube breaks, *it will implode!* Shattered glass and the yoke can fly 6 feet or more from the implosion. Use care when replacing any display.

UPRIGHT CABINET

To Remove Color X-Y Display:

1. Open the control panel (see *Figure 3-2, The Control Panel*).
2. Lift up on the glass shield. Slide the retainer clip off the wood cleat and remove through the cut-out. Then remove the glass shield by sliding it down and out of the cabinet.
3. Remove the cardboard bezel.
4. Open the rear access panel and unplug the 15-pin display harness connector.
5. Remove the four sets of hardware that secure the display frame to the wood shelf.
6. Carefully pull the display out through the front of the cabinet.

Disassemble in the order indicated. (Circled numbers match the numbered instructions.)

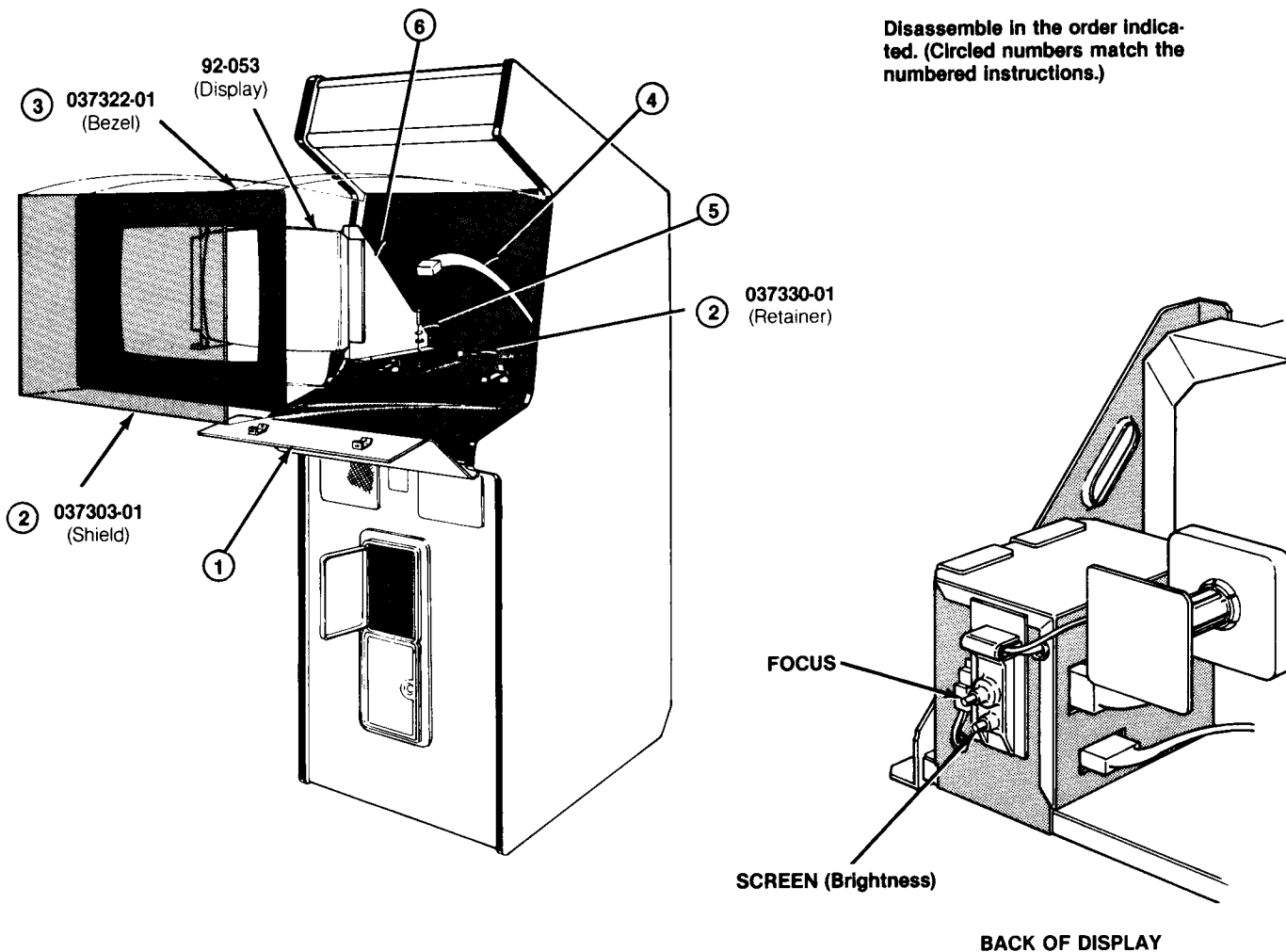
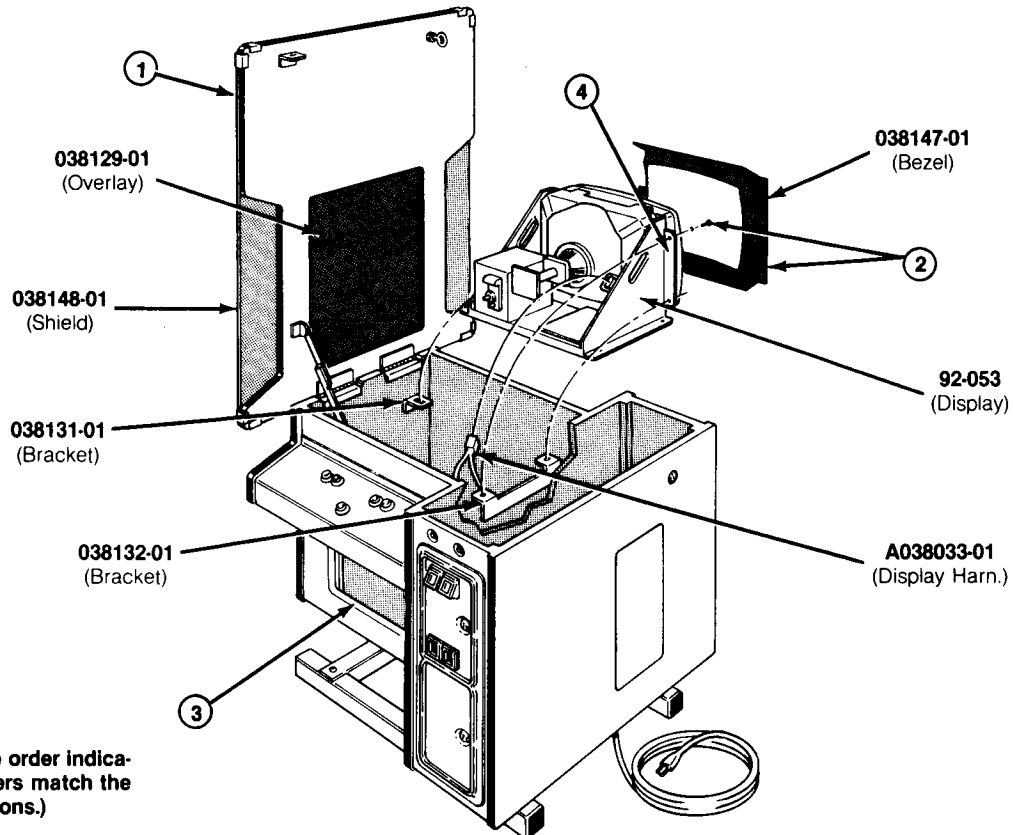

Figure 3-5 Upright Video Display Removal

COCKTAIL TABLE CABINET

To Remove Color X-Y Display:

1. **Unplug the game.** Unlock and open the table top and access panel (see *Chapter 1*).
2. Remove the display bezel. Remove the four hex-head machine screws that attach the display frame to the metal display mounting brackets.
3. Reach through the access panel opening and unplug the 15-pin video display connector underneath the display.
4. Grasp the video-display frame flanges on each side of the display and carefully lift the display assembly up and out the cabinet. After servicing, reassemble in reverse order.



Disassemble in the order indicated. (Circled numbers match the numbered instructions.)

**Figure 3-5 continued, Cocktail Video Display Removal
VA037294-01 A and VA038100-01 A
Parts List**

Part No.	Description
A038033-01	Cocktail Display Harness Assembly
92-053	19-Inch Wells-Gardner Color X-Y Video Display
037303-01	Upright Display Shield
037322-01	Upright Display Bezel
037330-01	Upright Display Shield Retainer
038129-01	Cocktail Display Overlay
038131-01	Cocktail Display Mounting Bracket <i>(for left side)</i>
038132-01	Cocktail Display Mounting Bracket <i>(for right side)</i>
038147-01	Cocktail Display Bezel
038148-01	Cocktail Display Shield with Graphics

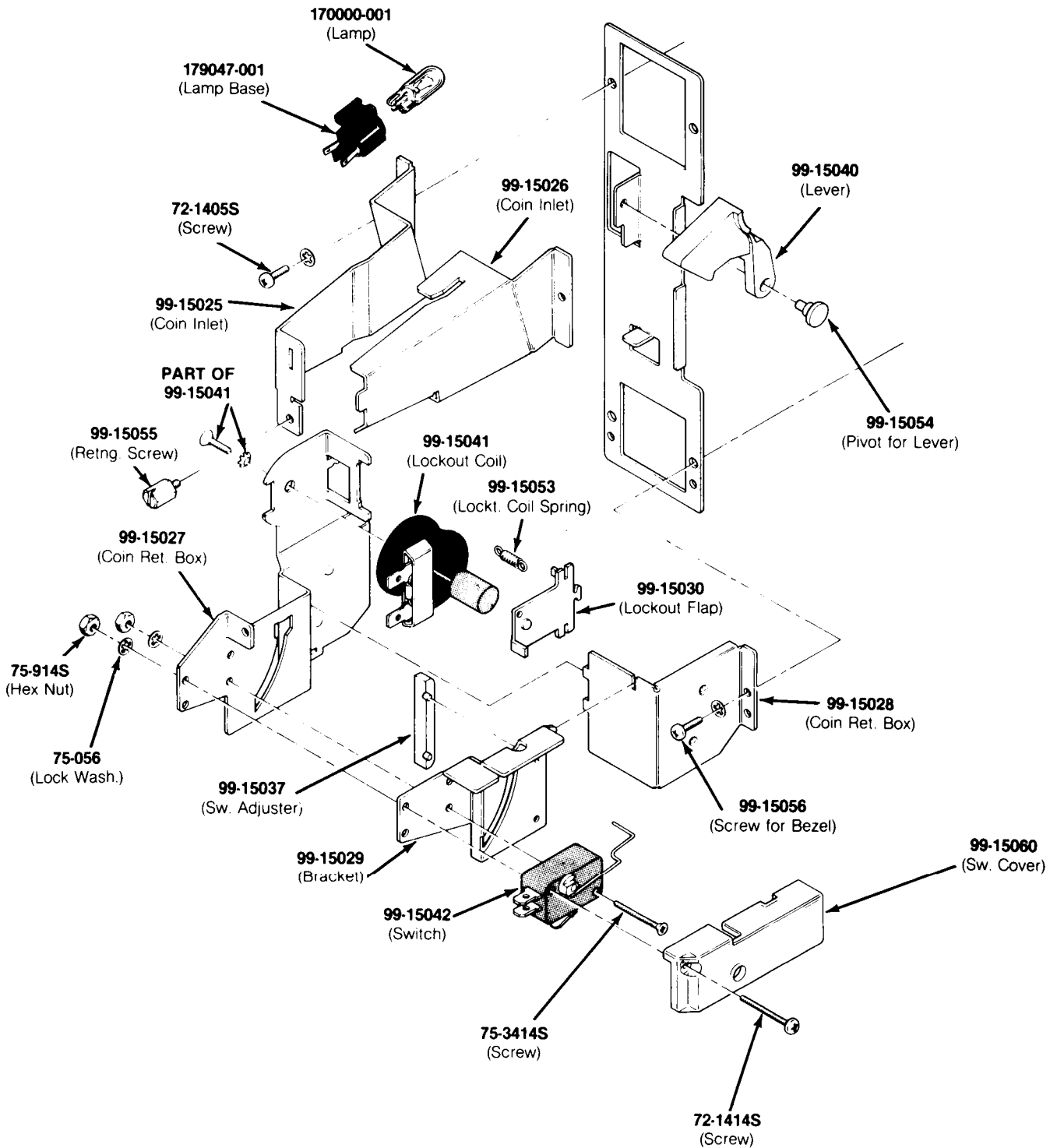

**Figure 3-6 Vertical-Mounted Coin Door
A037619-xx B**

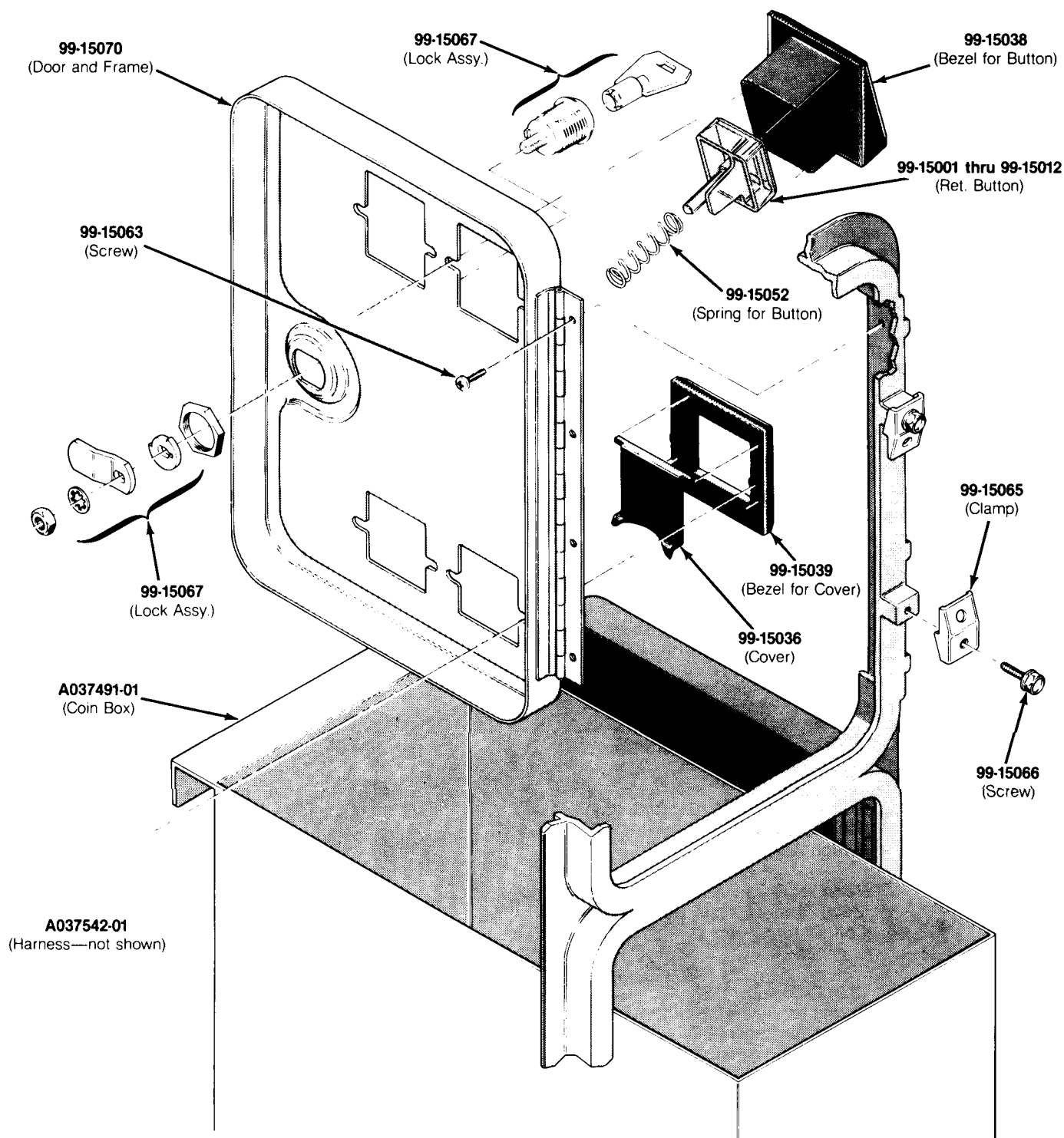

A037619-01 — U.S. 25¢/25¢ Coin Door
 A037619-02 — U.S. 50¢/50¢ Coin Door
 A037619-03 — Canadian 25¢/25¢ Coin Door
 A037619-04 — British 10 P/10 P Coin Door
 A037619-05 — British 10 P/50 P Coin Door
 A037619-06 — British 20 P/50 P Coin Door
 A037619-07 — Australian 20¢/20¢ Coin Door

A037619-08 — German 1 DM/1 DM Coin Door
 A037619-09 — German 2 DM/1 DM Coin Door
 A037619-10 — German 2 DM/5 DM Coin Door
 A037619-11 — German 1 DM/5 DM Coin Door
 A037619-12 — 5 Fr/5 Fr Coin Door
 A037619-13 — Swiss 1 Fr/1 Fr Coin Door
 A037619-14 — French 1 Fr/1 Fr Coin Door

A037619-15 — French 2 Fr/1 Fr Coin Door
 A037619-16 — Swedish 1 Kr/1 Kr Coin Door
 A037619-17 — Spanish 25 Pts/25 Pts Coin Door
 A037619-18 — Italian 100 L/100 L Coin Door
 A037619-19 — Hong Kong \$1/\$1 Coin Door
 A037619-20 — Japanese 100Y/100Y Coin Door

Figure 3-6 Vertical-Mounted Coin Door, continued
A037619-xx B

Figure 3-6 Vertical-Mounted Coin Door, continued Parts List

Part No.	Description
A037491-01	Coin Box <i>(Not included in assembly)</i>
A037542-01	Harness Assembly
71006-035	Metal Coin Mechanism
72-1405S	#4-40 x 1/16-Inch Cross-Recessed Pan-Head Steel Machine Screw
72-1414S	#4-40 x 1/8-Inch Cross-Recessed Pan-Head Steel Machine Screw
75-056	#6 Internal-Tooth Zinc-Plated Steel Lock Washer
75-914S	#4-40 Steel Machine Hex Nut
75-3414S	#4-40 x 1/8-Inch 82° Cross-Recessed Flat-Head Steel Machine Screw
99-15001	Coin Return Button with U.S. 25¢ Price Plate
99-15002	Coin Return Button with U.S. \$1 Price Plate
99-15003	Coin Return Button with German 1 DM Price Plate
99-15004	Coin Return Button with German 2 DM Price Plate
99-15005	Coin Return Button with German 5 DM Price Plate
99-15006	Coin Return Button with Belgian 5 Fr Price Plate
99-15007	Coin Return Button with French 1 Fr Price Plate
99-15008	Coin Return Button with Japanese 100 Yen Price Plate
99-15009	Coin Return Button with British 10 Pence Price Plate
99-15010	Coin Return Button with Australian 20¢ Price Plate
99-15011	Coin Return Button with Italian 100 Lire Price Plate
99-15012	Coin Return Button with U.S. 50¢ (2 x 25¢) Price Plate
99-15025	Left Half of Coin Inlet
99-15026	Right Half of Coin Inlet
99-15027	Side Plate of Coin Return Box
99-15028	Base Plate of Coin Return Box
99-15029	Switch Bracket
99-15030	Flap for Lockout Coil <i>(U.S. 25¢)</i>
99-15036	Metal Coin Return Cover
99-15037	Switch Adjuster
99-15038	Bezel for Coin Return Button
99-15039	Metal Bezel for Coin Return Cover
99-15040	Coin Return Lever
99-15041	Lockout Coil
99-15042	Coin Switch for U.S. 25¢
99-15052	Spring for Coin Return Button
99-15053	Spring for Lockout Coil
99-15054	Pivot for Coin Return Lever
99-15055	Retaining Screw
99-15056	Screw for Both Bezels
99-15060	Switch Cover
99-15063	Screw for Hinge
99-15065	Clamp for Frame
99-15066	Screw for Clamp
99-15067	Lock Assembly
99-15070	Door and Frame
170000-001	6.3V Miniature Wedge Base Incandescent Lamp
179047-001	Lamp Base

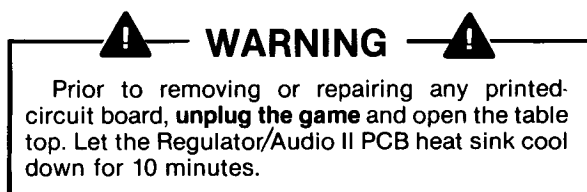

To Remove Printed-Circuit Board:

1. Open the *Upright cabinet rear access panel* or *Cock-tail cabinet table top*.
2. Locate the hardware that secures the PCB to the cabinet, and remove this hardware. (Each PCB has one screw and two spacers to secure it.)
3. If you are removing the game board, first remove the tie wraps that fasten the edge connectors to the game PCB. Then unplug the edge connectors on the game PCB. If you are removing the Regulator/Audio II PCB, disconnect the five small harness connectors on this board. For the cocktail cabinet, next grasp the plastic retainer at the top of the PCB and gently lift it up to release the top of the PCB from the retainer.
4. Carefully slide the PCB straight out of its slots. Be careful not to twist the board, as this may loosen connections or components. Replace or repair as required.

- Reinstall the PCB, making sure that the connectors are properly plugged in. Note that they are keyed to fit on only one way, so if they don't slip on easily, don't force them! **A reversed connector will probably damage your game** and will void the warranty.
- Replace the hardware that secures the PCB to the cabinet wall. Reinstall the fasteners used to secure the edge connectors to the PCB. Close and lock the rear access panel or table top.
- Check that the operation of the game is correct by performing the self-test. This is especially important with any game when you repair a PCB. Normally the only adjustments on this game are option switch changes (made on the 8-toggle DIP switch). Unless you are a qualified technician, **do not turn any of the knobs near the game PCB's edge connector. Also do not turn the small knobs on the Regulator/Audio II PCB.**

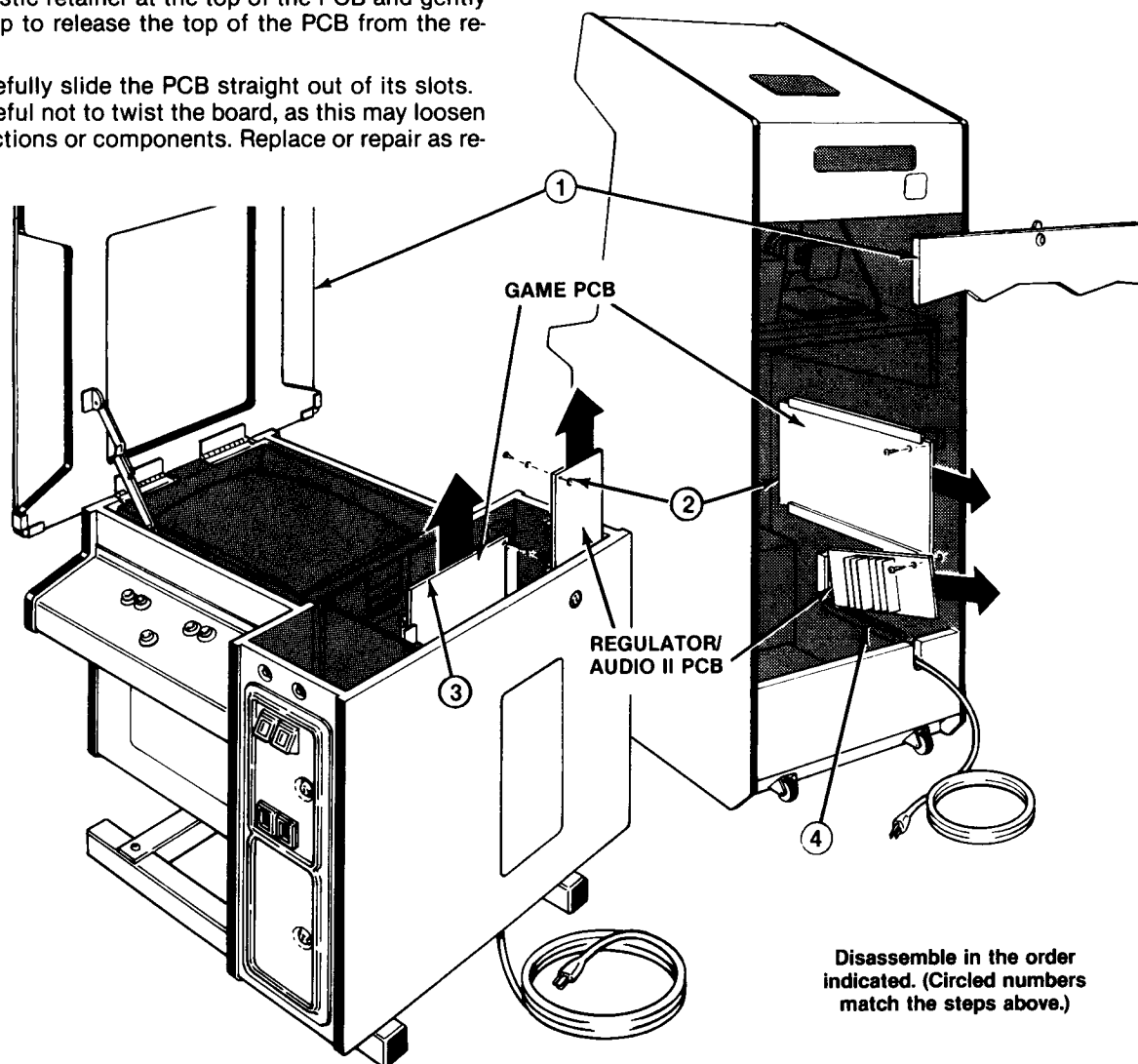

Disassemble in the order indicated. (Circled numbers match the steps above.)

Figure 3-7 Printed-Circuit Board Removal

NOTICE TO ALL PERSONS RECEIVING THIS DRAWING
 CONFIDENTIAL: Reproduction forbidden without the specific written permission of Atari Inc., Sunnyvale, CA. This drawing is only conditionally issued and neither receipt nor possession thereof confers any right in, or license to use, the subject matter thereof nor any right to reproduce this information shown thereon for any purpose other than for manufacture by vendors of Atari Inc. and for manufacture under the corporation's written license. No right is granted to reproduce this drawing or the subject matter thereof, unless by written agreement with or written permission from the corporation.

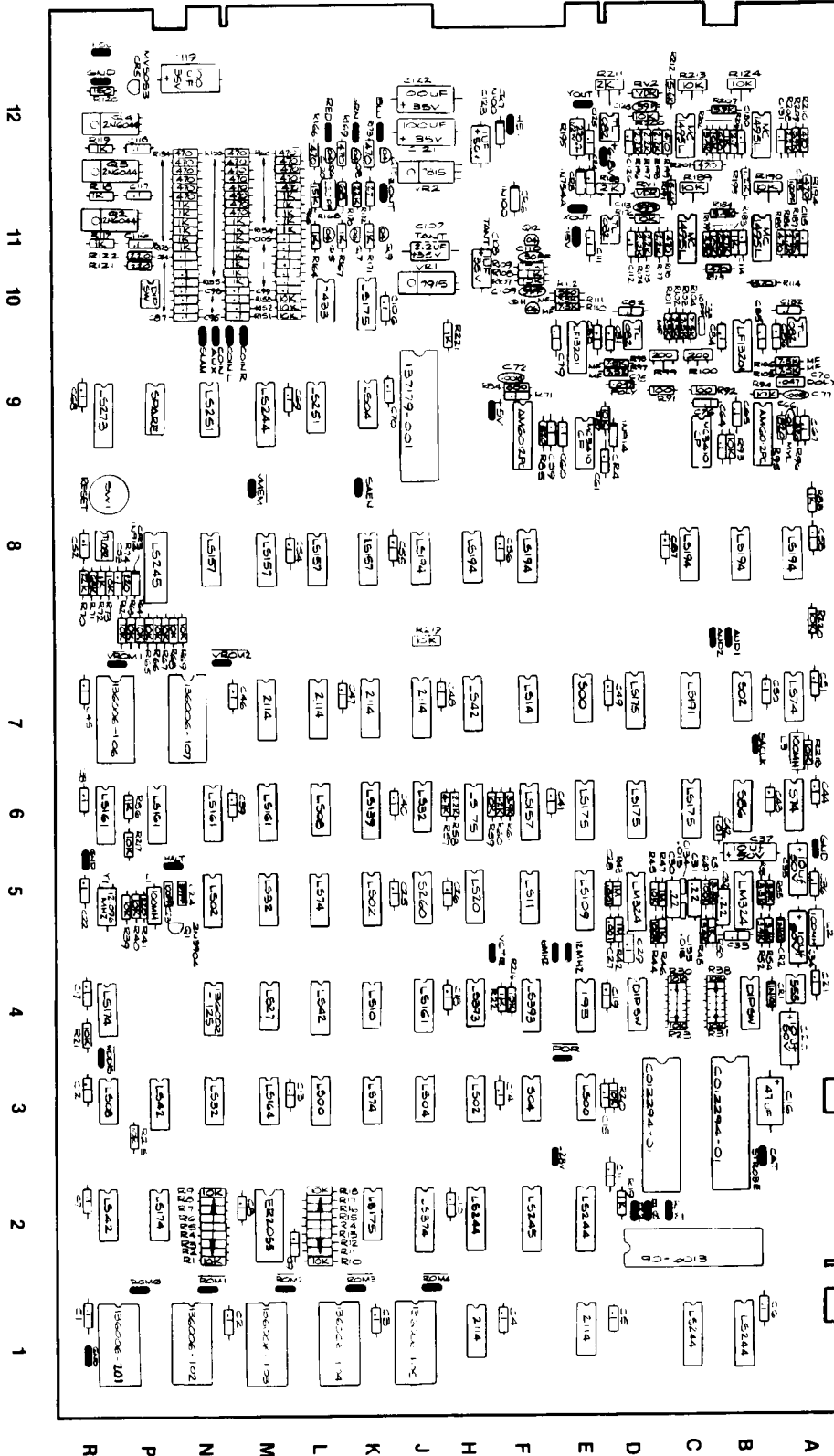

Figure 3-8 Space Duel™ Game PCB Assembly
 A036837-01 & -02 B

Figure 3-8 Space Duel™ Game PCB Assembly, continued Parts List

Part No.	Description (Reference Designations and Locations in Bold)
C012294-01	Audio I/O N-Channel MOS/LSI Custom Chip (B3, C/D3)
19-315103	10K Ohm Vertical PCB-Mounting Cermet Trimpot (R189, 190, 213, 214) <i>Acceptable substitute is part no. 119002-103.</i>
19-315201	200 Ohm Vertical PCB-Mounting Cermet Trimpot (R99, 100) <i>Acceptable substitute is part no. 119002-201.</i>
19-315202	2K Ohm Vertical PCB-Mounting Cermet Trimpot (R188, 211) <i>Acceptable substitute is part no. 119002-202.</i>
21-101103	.01 μ f, \pm 10%, Radial-Lead Epoxy-Dipped 100V Mylar Capacitor (For -02 PCB assy. only: C66)
21-101153	.015 μ f, \pm 10%, Radial-Lead Epoxy-Dipped 100V Mylar Capacitor (C133, 134)
24-350107	100 μ f Aluminum Electrolytic Fixed Axial-Lead 35V Capacitor (C119, 121, 122)
24-500105	1 μ f Aluminum Electrolytic Fixed Axial-Lead 50V Capacitor (C123)
24-500106	10 μ f Aluminum Electrolytic Fixed Axial-Lead 50V Capacitor (C20, 34, 35, 37)
24-500476	47 μ f Aluminum Electrolytic Fixed Axial-Lead 50V Capacitor (C16)
27-102182	.0018 μ f, \pm 10%, Radial-Lead Ceramic-Disc 1000V Capacitor (For -01 PCB assy. only: C77. For -02 PCB assy. only: C72)
29-006	1 μ f, \pm 10%, 35V Tantalum Capacitor (C108)
29-088	.1 μ f Ceramic-Disc 25V Radial-Lead Capacitor (C1-15, 17-19, 21, 22, 25, 26, 29, 33, 36, 38-41, 43-58, 68-70, 79-82, 84-106, 111, 112, 114-118, 124-126, 130-132. Also, for -01 PCB assy. only: C60, 61, 64, 76. For -02 PCB assy. only: C59, 65, 67, 71)
31-1N100	100V Type-1N100 Switching Diode (CR1, 2, 6, 7)
31-1N914	75V Type-1N914 Switching Diode (CR3, 4)
33-2N3906	Type-2N3906 PCB Switching and Amplifying Transistor (Q7, 11)
34-2N3904	Type-2N3904 NPN 60V 1-Watt Transistor (Q1, 5, 6, 8-10, 12)
34-2N6044	Type-2N6044 Darlington NPN Transistor (Q2, 3, 4)
37-TL082CP	Type-TL082 Integrated Circuit (A10, D10, D/E11, D/E12, R8)
37-555	Type-555 Integrated Circuit (A4)
37-1495	Type-MC1495L Integrated Circuit (A/B11, A/B12, C11, C12)
37-7433	Type-7433 Integrated Circuit (L10)
37-13201	Type-LF13201 Integrated Circuit (B10, E10)
37-74193	Type-74193 Integrated Circuit (E4)
37-LM324	Type-LM324 Integrated Circuit (B5, D5)
37-74LS00	Type-74LS00 Integrated Circuit (E3, L3)
37-74LS02	Type-74LS02 Integrated Circuit (H3, K5, N5)
37-74LS04	Type-74LS04 Integrated Circuit (J3, K9)
37-74LS08	Type-74LS08 Integrated Circuit (L6, R3)
37-74LS10	Type-74LS10 Integrated Circuit (K4)
37-74LS14	Type-74LS14 Integrated Circuit (F7)
37-74LS20	Type-74LS20 Integrated Circuit (H5)
37-74LS27	Type-74LS27 Integrated Circuit (M4)
37-74LS32	Type-74LS32 Integrated Circuit (J6, M5, N3)
37-74LS42	Type-74LS42 Integrated Circuit (H7, L4, P3, R2)
37-74LS74	Type-74LS74 Integrated Circuit (A7, K3, L5)
37-74LS109	Type-74LS109 Integrated Circuit (E5)
37-74LS139	Type-74LS139 Integrated Circuit (K6)
37-74LS157	Type-74LS157 Integrated Circuit (F6, K8, L8, M8, N8)
37-74LS161	Type-74LS161 Integrated Circuit (J4, M6, N6, P6, R6)
37-74LS164	Type-74LS164 Integrated Circuit (M3)
37-74LS174	Type-74LS174 Integrated Circuit (P2, R4)
37-74LS175	Type-74LS175 Integrated Circuit (C6, D6, D7, E6, H6, K2, K10)

[Continued on next page]

Figure 3-8 Space Duel™ Game PCB Assembly, continued Parts List

Part No.	Description (Reference Designations and Locations in Bold)
37-74LS191	Type-74LS191 Integrated Circuit (C7)
37-74LS194	Type-74LS194 Integrated Circuit (A8, B8, C8, F8, H8, J8)
37-74LS244	Type-74LS244 Integrated Circuit (B1, C1, E2, H2, M9)
37-74LS245	Type-74LS245 Integrated Circuit (F2, P8)
37-74LS251	Type-74LS251 Integrated Circuit (L9, N9)
37-74LS273	Type-74LS273 Integrated Circuit (R9)
37-74LS374	Type-74LS374 Integrated Circuit (J2)
37-74LS393	Type-74LS393 Integrated Circuit (F4, H4)
37-74S00	Type-74S00 Integrated Circuit (E7)
37-74S02	Type-74S02 Integrated Circuit (B7)
37-74S04	Type-74S04 Integrated Circuit (F3)
37-74S74	Type-74S74 Integrated Circuit (A6)
37-74S260	Type-74S260 Integrated Circuit (J5)
37-7815	+ 15V Voltage Regulator (VR2)
37-7915	- 15V Voltage Regulator (VR1)
38-MV5053	Type-MV5053 Light-Emitting Diode (CR5)
41-3003	100 μ H, \pm 10%, Hot-Molded Plastic Fixed R.F. Choke (L1, 2, 3) <i>Acceptable substitute is part no. 141002-001.</i>
62-001	SPST Momentary Pushbutton Switch (Reset)
66-114P1T	4-Station Single-Throw, Dual-Inline-Package Bit Switch (P10)
66-118P1T	8-Station Single-Throw, Dual-Inline-Package Bit Switch (B4, D4)
72-6610S	#6 x $\frac{3}{8}$ -Inch Phillips-Head Screw (for mounting PCB to cabinet wall)
78-24012	5-Inch Beaded Nylon Tie Wrap (for PCB edge connectors)
79-42C22	22-Contact Medium-Insertion-Force Integrated Circuit Socket (M2)
79-42C24	24-Contact Medium-Insertion-Force Integrated Circuit Socket (J1, K/L1, M1, N/P1, N/P7, R1, R7)
79-42C40	40-Contact Medium-Insertion-Force Integrated Circuit Socket (B3, C2, C/D3, J9)
81-4302	Nylon Snap-In Fastener
90-6013	Microprocessor (C2)
90-7033	Random-Access Memory (E1, H1, J7, K7, L7, M7)
034536-02	Cocktail Foam Vibration Damper
034536-03	Foam Vibration Damper
035745-02	18-Inch Plastic PCB Retainer
110000-101	100 Ohm, \pm 5%, $\frac{1}{4}$ W Resistor (R91, 92)
110000-102	1K Ohm, \pm 5%, $\frac{1}{4}$ W Resistor (R19, 22, 46, 50, 56, 72, 83, 108, 117-119, 123-128, 135-142, 154-158, 164, 167, 171, 183, 205, 221)
110000-103	10K Ohm, \pm 5%, $\frac{1}{4}$ W Resistor (R1-18, 20, 21, 23-40, 45, 59, 62-69, 73, 107, 151-153, 176, 180, 200, 203, 215-220. <i>Also, for -01 PCB assy. only: 87, 93, 94.</i>)
110000-104	100K Ohm, \pm 5%, $\frac{1}{4}$ W Resistor (R44, 49)
110000-105	1M Ohm, \pm 5%, $\frac{1}{4}$ W Resistor (R42, 43, 47)
110000-122	1.2K Ohm, \pm 5%, $\frac{1}{4}$ W Resistor (R60, 193)
110000-151	150 Ohm, \pm 5%, $\frac{1}{4}$ W Resistor (R120)
110000-153	15K Ohm, \pm 5%, $\frac{1}{4}$ W Resistor (R109, 165)
110000-221	220 Ohm, \pm 5%, $\frac{1}{4}$ W Resistor (R41, 74, 121, 122)
110000-222	2.2K Ohm, \pm 5%, $\frac{1}{4}$ W Resistor (R58, 174, 175, 177, 186, 196-198, 208)
110000-223	22K Ohm, \pm 5%, $\frac{1}{4}$ W Resistor (R70, 170)
110000-270	27 Ohm, \pm 5%, $\frac{1}{4}$ W Resistor (R172)
110000-272	2.7K Ohm, \pm 5%, $\frac{1}{4}$ W Resistor (R182, 206)

[Continued on next page]

Figure 3-8 Space Duel™ Game PCB Assembly, continued Parts List

Part No.	Description (Reference Designations and Locations in Bold)
110000-332	3.3K Ohm, $\pm 5\%$, $\frac{1}{4}$ W Resistor (R51, 53-55)
110000-392	3.9K Ohm, $\pm 5\%$, $\frac{1}{4}$ W Resistor (R48, 52, 61, 179, 184, 187, 202, 207, 209)
110000-471	470 Ohm, $\pm 5\%$, $\frac{1}{4}$ W Resistor (R113, 114, 129-134, 143-150, 159-163, 166, 169, 173, 178, 185, 194, 199, 201, 210)
110000-472	4.7K Ohm, $\pm 5\%$, $\frac{1}{4}$ W Resistor (R57)
110000-561	560 Ohm, $\pm 5\%$, $\frac{1}{4}$ W Resistor (R112)
110000-562	5.6K Ohm, $\pm 5\%$, $\frac{1}{4}$ W Resistor (R191, 212)
110000-680	68 Ohm, $\pm 5\%$, $\frac{1}{4}$ W Resistor (R168)
110000-681	680 Ohm, $\pm 5\%$, $\frac{1}{4}$ W Resistor (R181, 204. Also, for -02 PCB assy. only: R84.)
110000-683	68K Ohm, $\pm 5\%$, $\frac{1}{4}$ W Resistor (R71)
110000-821	820 Ohm, $\pm 5\%$, $\frac{1}{4}$ W Resistor (For -02 PCB assy. only: R85, 95, 96)
110001-271	270 Ohm, $\pm 5\%$, $\frac{1}{2}$ W Resistor (R195)
110003-752	7.5K Ohm, $\pm 1\%$, $\frac{1}{8}$ W Resistor (R97, 98, 101-106, 110, 111)
110004-001	Voltage Dependent Resistor (RV1, 2)
121007-473	.047 μ f, $\pm 10\%$, Radial-Lead Epoxy-Dipped 50V Polycarbonate Capacitor (C75, 78)
122000-225	2.2 μ f, $\pm 10\%$, 35V Tantalum Capacitor (C107)
122002-102	.001 μ f, Ceramic-Disc 50V Radial-Lead Capacitor (C27, 28)
122005-103	.01 μ f, Ceramic-Disc 25V Radial-Lead Capacitor (C42)
122008-224	.22 μ f, Ceramic-Disc 25V Radial-Lead Capacitor (C30-32)
128002-100	10 pf Radial-Lead Epoxy-Dipped 100V Mica Capacitor (C83)
128002-101	100 pf Radial-Lead Epoxy-Dipped 100V Mica Capacitor (C23, 135)
128002-151	150 pf Radial-Lead Epoxy-Dipped 100V Mica Capacitor (C110)
128002-221	220 pf Radial-Lead Epoxy-Dipped 100V Mica Capacitor (C120)
128002-390	39 pf Radial-Lead Epoxy-Dipped 100V Mica Capacitor (C24, 109, 113, 128)
131002-001	6.8V, 400 mW, $\pm 5\%$, Zener Diode (CR8)
136002-125	Programmable Read-Only Memory (N4)
136006-102	Programmable Read-Only Memory (N/P1)
136006-103	Programmable Read-Only Memory (M1)
136006-104	Programmable Read-Only Memory (K/L1)
136006-105	Programmable Read-Only Memory (J1)
136006-106	Programmable Read-Only Memory (R7)
136006-107	Programmable Read-Only Memory (N/P7)
136006-201	Programmable Read-Only Memory (R1)
137002-001	Type-74S86 Integrated Circuit (B6)
137149-001	Type-74LS11 Integrated Circuit (F5)
137158-002	Type-AM6012PC 12-Bit Digital-to-Analog Converter (For -02 PCB assy. only: A/B9, F9)
137160-003	Type-MC3410 10-Bit Digital-to-Analog Converter (For -01 PCB assy. only: C9, E9)
137161-001	Read-Only Memory (M2) Note: If you replace this part, you must erase this ROM before locking up the game. See Self-Test Procedure, in this manual for instructions. If you do not erase the EAROM, the self-test will show the ROM to be "defective" by displaying the letter E on the screen.
137179-001	Address Controller (J9)
144000-001	12.096 MHz, $\pm .005\%$, Crystal (Y1)
175004-706	# Spacer for Mounting Printed Circuit Board
179051-001	Test Point Acceptable substitute is part no. 020670-01.

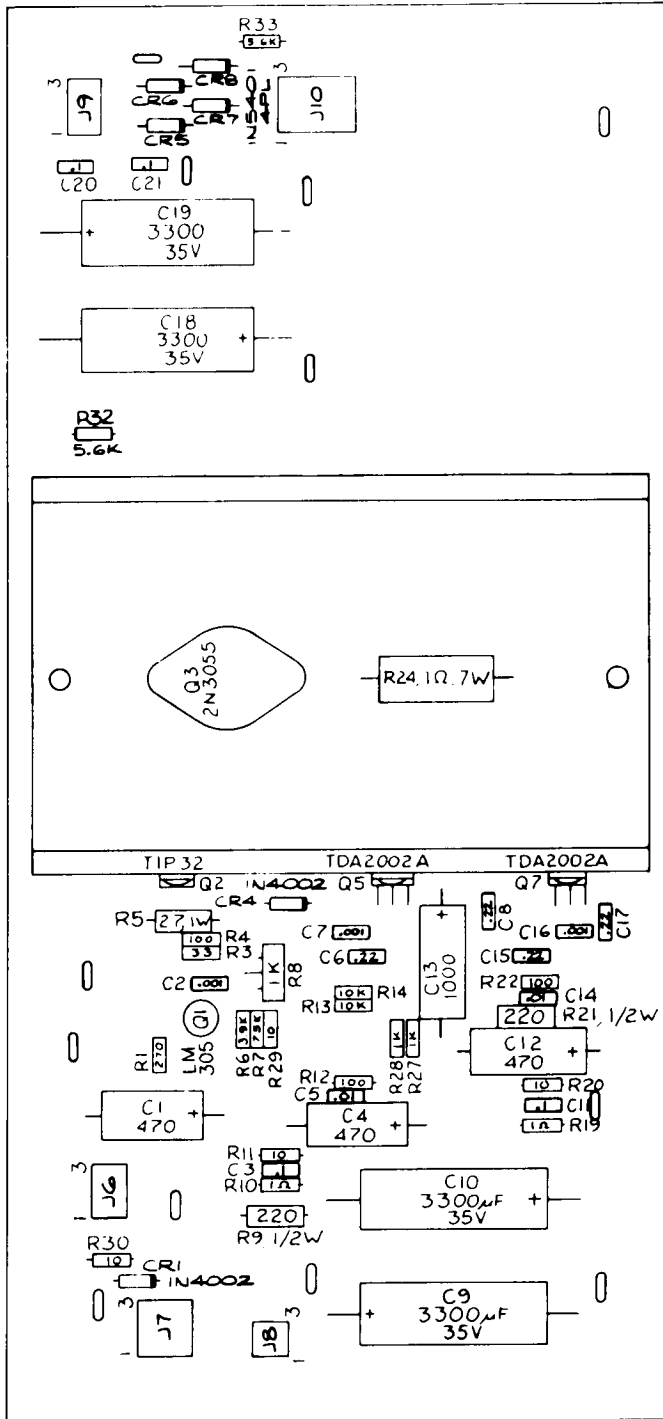

NOTICE TO ALL PERSONS RECEIVING THIS DRAWING
CONFIDENTIAL: Reproduction forbidden without the specific written permission of Atari, Inc., Sunnyvale, CA. This drawing is only conditionally issued, and neither receipt nor possession thereof confers or transfers any right in, or license to use, the subject matter of the drawing or any design or technical information shown thereon, nor any right to reproduce this drawing or any part thereof. Except for manufacture by vendors of Atari, Inc., and for manufacture under the corporation's written license, no right is granted to reproduce this drawing or the subject matter thereof, unless by written agreement with or written permission from the corporation.

Figure 3-9 Regulator/Audio II PCB Assembly
A035435-04 B

Figure 3-9 Regulator/Audio II PCB Assembly Parts List

Part No.	Description (Reference Designations and Locations in Bold)
19-100P1015	.1 Ohm, $\pm 3\%$, 7W Wirewound Resistor (R24)
19-315102	1K Ohm Vertical PCB-Mounting Cermet Trimpot (R8) <i>Acceptable substitute is part no. 119002-102</i>
24-250108	1000 μf Aluminum Electrolytic Fixed Axial-Lead 25V Capacitor (C13)
24-250477	470 μf Aluminum Electrolytic Fixed Axial-Lead 25V Capacitor (C1, 4, 12)
24-350338	3300 μf Aluminum Electrolytic Fixed Axial-Lead 35V Capacitor (C9, 10, 18, 19)
29-088	.1 μf Ceramic-Disc 25V Radial-Lead Capacitor (C3, 11, 20, 21)
31-1N4002	100V 1-Amp. Silicon Rectifier Type 1N4002 Diode (CR1, 4)
31-1N5401	100V 3-Amp. Silicon Rectifier Type 1N5401 Diode (CR5-8)
33-TIP32	PNP Power Transistor, Type TIP32 (Q2)
34-2N3055	NPN Silicon Transistor, Type 2N3055 (Q3)
37-LM305	5V Linear Voltage Regulator (Q1)
72-1608C	#6-32 \times 1/2-Inch Cross-Recessed Pan-Head Corrosion-Resistant Steel Machine Screw (Q3)
72-6606S	#6 \times 3/8-Inch Pan-Head Thread-Forming Cross-Recessed Type-AB Zinc-Plated-Steel Screw (Q5, 7)
72-6810S	#8 \times 3/8-Inch Phillips-Head Screw (<i>attaches PCB to cabinet wall</i>)
75-F60405	#6-32 \times 1/4-Inch Binder-Head Nylon Screw (Q2)
75-99516	#6-32 Nut/Washer Assembly (Q3)
78-16008	Thermally Conductive Compound (Q3)
78-16014	Thermally Conductive Silicon Insulator (Q2)
79-58306	6-Position Connector Receptacle (J6, 9)
79-58308	9-Position Connector Receptacle (J7)
79-58346	12-Position Connector Receptacle (J10)
79-58354	4-Position Connector Receptacle (J8)
020670-01	Test Point
034531-01	Heat Sink
034536-02	Foam Vibration Damper
034536-03	Cocktail Foam Vibration Damper
035745-06	5-Inch Plastic Cocktail PCB Retainer
100015-103	.01 μf Ceramic-Disc 25V Radial-Lead Capacitor (C5, C14) <i>Acceptable substitute is part no. 122005-103</i>
110000-010	1 Ohm, $\pm 5\%$, 1/4W Resistor (R10, 19)
110000-100	10 Ohm, $\pm 5\%$, 1/4W Resistor (R11, 20, 29, 30)
110000-101	100 Ohm, $\pm 5\%$, 1/4W Resistor (R4, 12, 22)
110000-102	1K Ohm, $\pm 5\%$, 1/4W Resistor (R27, 28)
110000-103	10K Ohm, $\pm 5\%$, 1/4W Resistor (R13, 14)
110000-271	270 Ohm, $\pm 5\%$, 1/4W Resistor (R1)
110000-330	33 Ohm, $\pm 5\%$, 1/4W Resistor (R3)
110000-392	3.9K Ohm, $\pm 5\%$, 1/4W Resistor (R6)
110000-562	5.6K Ohm, $\pm 5\%$, 1/4W Resistor (R32, 33)
110000-752	7.5K Ohm, $\pm 5\%$, 1/4W Resistor (R7)
110001-221	220 Ohm, $\pm 5\%$, 1/2W Resistor (R9, 21)
110009-027	2.7 Ohm, $\pm 5\%$, 1W Resistor (R5)
122002-102	.001 μf Ceramic-Disc Minimum 25V Radial-Lead Capacitor (C2, 7, 16)
122004-224	.22 μf Ceramic-Disc 25V Capacitor (C6, 8, 15, 17)
137151-002	Type TDA2002A 8W Linear Audio Amplifier Integrated Circuit (Q5, 7)
175004-708	#8 Spacer for Mounting Printed Circuit Board (<i>2 required</i>)

NOTICE TO ALL PERSONS RECEIVING THIS DRAWING
CONFIDENTIAL: Reproduction forbidden without the specific written permission of Atari, Inc., Sunnyvale, CA. This drawing is only conditionally issued, and neither receipt nor possession thereof confers or transfers any right in, or license to use, the subject matter of the drawing or any design or technical information shown thereon, nor any right to reproduce this drawing or any part thereof. Except for manufacture by vendors of Atari, Inc., and for manufacture under the corporation's written license, no right to reproduce this drawing is granted or the subject matter thereof unless by written agreement with or written permission from the corporation.

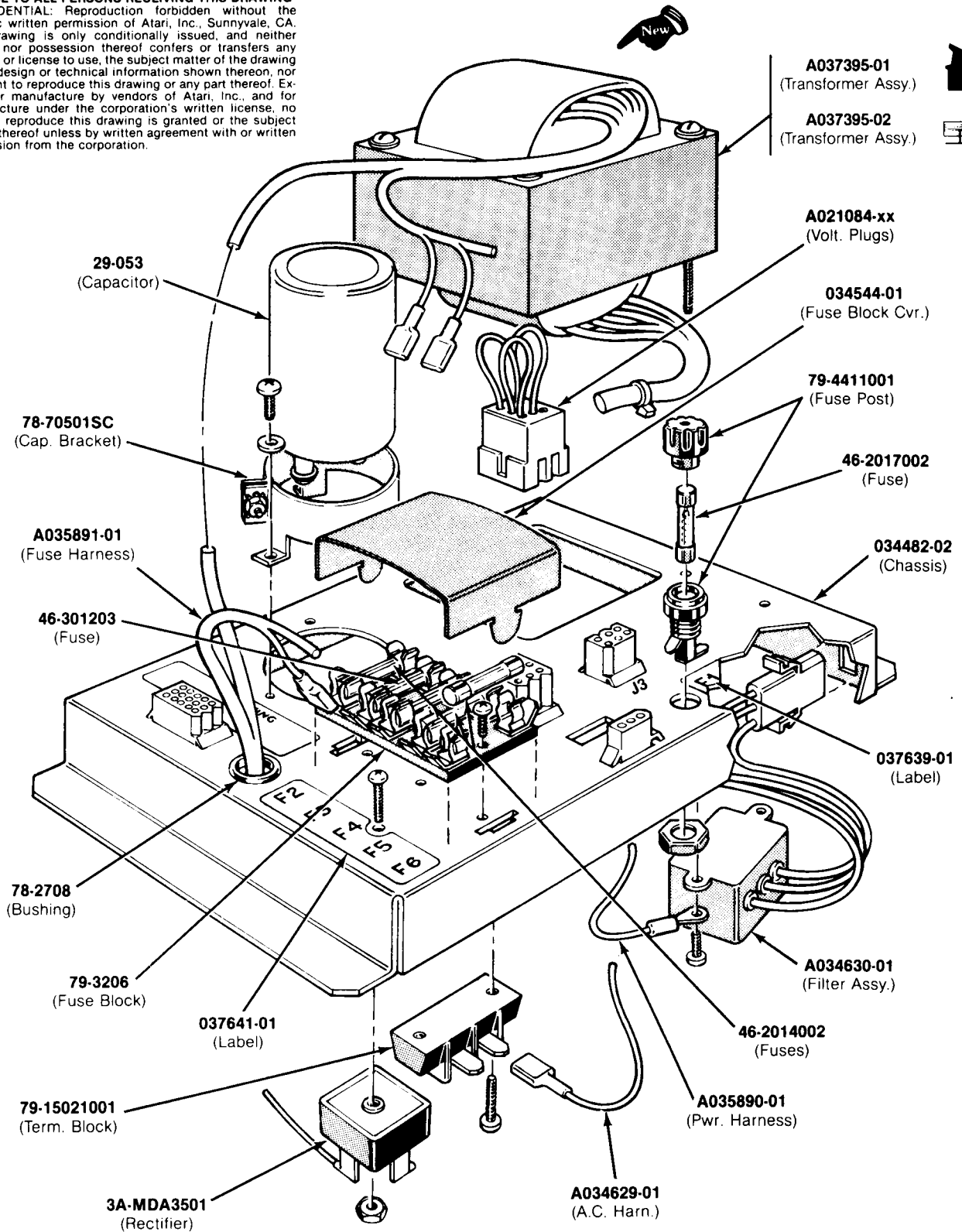

**Figure 3-10 Color X-Y Power Supply Assemblies
 A037396-xx B and A037875-xx B**

Figure 3-10 Color X-Y Power Supply Assemblies Parts List

Part No.	Description (Reference Designations in Bold)
A021084-01	Voltage Plug for 100V (violet)
A021084-02	Voltage Plug for 120V (yellow)
A021084-04	Voltage Plug for 220V (blue)
A021084-05	Voltage Plug for 240V (brown)
A034629-01	A.C. Harness Assembly
A034630-01	RFI Filter Assembly (FL1)
A035890-01	Power Harness Assembly
A035891-01	Fuse Harness Assembly
A037395-01	Upright Transformer Assembly (T1)
A037395-02	Cocktail Transformer Assembly (T1)
29-053	27,000 μ f 15 VDC Electrolytic Capacitor (C1)
3A-MDA3501	Bridge Rectifier, Type MDA 3501 (CR1)
46-2014002	4-Amp. 250V 3AG Slow-Blow Glass Cartridge-Type Fuse (F2, F4-F6)
46-2017002	7-Amp. 250V 3AG Slow-Blow Glass Cartridge-Type Fuse (F1)
46-301203	20-Amp. 32V 3AG Slow-Blow Glass Cartridge-Type Fuse (F3)
78-2708	Nylon Type 6/6 Hole Bushing with $\frac{5}{8}$ -Inch Inside Diameter \times $\frac{55}{64}$ -Inch Outside Diameter \times $\frac{1}{4}$ -Inch Thick
78-70501SC	2-Inch Diameter Capacitor Mounting Bracket
79-15021001	2-Circuit Single-Row Terminal Block
79-3206	5-Position 3AG Fuse Block with $\frac{1}{4}$ -Inch Quick-Disconnect Terminals
79-4411001	Panel-Mounting Non-Indicating 3AG Cartridge-Type Fuse Post
034482-02	Power Supply Chassis
034544-01	Fuse Block Cover
037243-01	Metal Base Plate (not shown in illustration)
037639-01	Label for Fuse Value (F1)
037641-01	Label for Fuse Values (F2-F6)
037836-01	Metal Shield for Cocktail Power Supply (not shown in illustration)

Line Voltage Range	Voltage Selection Plug Wire Color
90-110 VAC (100)	Violet
105-135 VAC (120)	Yellow*
200-240 VAC (220)	Blue
220-260 VAC (240)	Brown

*This is the only plug provided on the North American power supply.

NOTE

A037671-01 power supply assembly has the 120V plug
 A037671-02 has the 100V, 220V and 240V plugs
 A037671-03 has the 220V and 240V plugs

WARNING

Fuse cover must be in place during
game operation.

YOUR COMMENTS, PLEASE!

Your comments will assist Atari in improving the usefulness of our publications. They are an important part of preparing for revisions of game manuals. No postage stamp is necessary if mailed in the U.S.A.

If you have any technical questions about certain ATARI games products, or are requesting additional publications, we will immediately forward your note to the appropriate person.

Page: _____ Comments: _____



Fill in if you wish a reply:

Name _____

Firm _____

Address _____

City _____ State _____ Zip _____

Area Code _____ Phone _____

Distributor

Operator

Other _____

Warranty

Seller warrants that its printed-circuit boards and parts thereon are free from defects in material and workmanship under normal use and service for a period of ninety (90) days from date of shipment. Seller warrants that its video displays (in games supplied with displays) are free from defects in material and workmanship under normal use and service for a period of thirty (30) days from date of shipment. None of the Seller's other products or parts thereof are warranted.

If the products described in this manual fail to conform to this warranty, Sellers' sole liability shall be, at its option, to repair, replace, or credit Buyer's account for such products which are returned to Seller during said warranty period, provided:

- (a) Seller is promptly notified in writing upon discovery by Buyer that said products are defective;
- (b) Such products are returned prepaid to Sellers' plant; and
- (c) Seller's examination of said products discloses to Seller's satisfaction that such alleged defects existed and were not caused by accident, misuse, neglect, alteration, improper repair, installation or improper testing.

In no event shall Seller be liable for loss of profits, loss of use, incidental or consequential damages.

Except for any express warranty set forth in a written contract between Seller and Buyer which contract supersedes the terms of this order, this warranty is expressed in lieu of all other warranties expressed or implied, including the implied warranties of merchantability and fitness for a particular purpose, and of all other obligations or liabilities on the Seller's part, and it neither assumes nor authorizes any other person to assume for the Seller any other liabilities in connection with the sale of products under this order.

The use of any non-Atari parts may void your warranty, according to the terms of the warranty. The use of any non-Atari parts may also adversely affect the safety of your game and cause injury to yourself and others. Be very cautious in using non-Atari-supplied components with our games, in order to insure your safety.

Atari distributors are independent, being privately owned and operated. In their judgment they may sell parts or accessories other than Atari parts or accessories. Atari cannot be responsible for the quality, suitability or safety of any non-Atari part or any modification including labor which is performed by such distributor.

This document is and contains confidential trade secret information of Atari, Inc.

This document is loaned under confidential custody for the sole purpose of operation, maintenance or repair of Atari equipment and may not be used by or disclosed to any person for any other purpose whatever, and remains the property of Atari, Inc.

Neither it nor the information it contains may be reproduced, used, or disclosed to persons not having a need to know consistent with the purpose of the loan, without written consent of Atari, Inc.

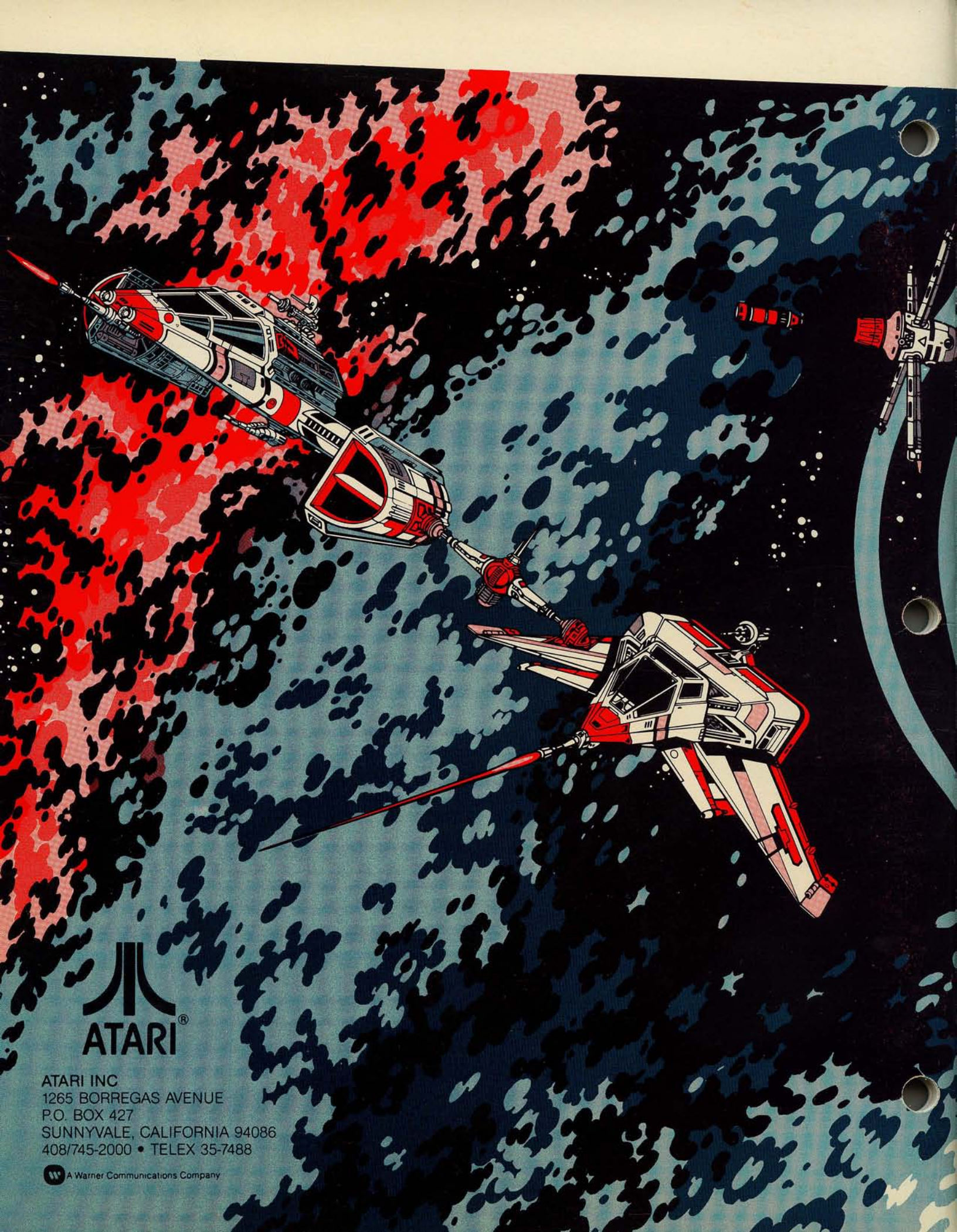

ATARI INC
1265 BORREGAS AVENUE
P.O. BOX 427
SUNNYVALE, CALIFORNIA 94086
408/745-2000 • TELEX 35-7488

 A Warner Communications Company