

SEGA

ARABIAN FIGHT

4 Player Conversion Kit for Optional 19" or 25"
Monitor

Installation/Owners Manual

SEGA ENTERPRISES, INC.

999-0133

ARABIAN FIGHT

by:

SEGA Enterprises, Inc. (U.S.A.)
2149 Paragon Drive
San Jose, California 95131
Phone Number (408) 435-0201
FAX Number (408) 435-0294

A 4 Player Conversion Kit for Upright Cabinet with Horizontal Monitor

NOTE: THIS EQUIPMENT HAS BEEN TESTED AND FOUND TO COMPLY WITH THE LIMITS FOR A CLASS A DIGITAL DEVICE, PURSUANT TO PART 15 OF THE FCC RULES. THESE LIMITS ARE DESIGNED TO PROVIDE REASONABLE PROTECTION AGAINST HARMFUL INTERFERENCE WHEN THE EQUIPMENT IS OPERATED IN A COMMERCIAL ENVIRONMENT. THIS EQUIPMENT GENERATES, USES, AND CAN RADIATE RADIO FREQUENCY ENERGY AND, IF NOT INSTALLED AND USED IN ACCORDANCE WITH THE INSTRUCTION MANUAL, MAY CAUSE HARMFUL INTERFERENCE TO RADIO COMMUNICATIONS. OPERATION OF THIS EQUIPMENT IN A RESIDENTIAL AREA IS LIKELY TO CAUSE HARMFUL INTERFERENCE IN WHICH CASE THE USER WILL BE REQUIRED TO CORRECT THE INTERFERENCE AT HIS/HER OWN EXPENSE.

This SEGA product has the copy right notice as follows: SEGA 1992
This signifies that this product was disclosed in 1992 and is the property of SEGA Enterprises.

Table of Contents

Introduction	3
Handling and Installation Precautions	3
Prevention of Counterfeiting and Conversion Labeling	3
Precautions Concerning the Place of Installation	3
System Requirements	4
Tools Required	5
Cabinet Preparation	5
Kit Component Verification	6
Installation Procedure	7
Monitor Card	7
License Seal	7
Side Decal	7
Marquee	7
Control Panel	7
Service Switch Assembly	8
Harness Installation	8
Cabinet 115 VAC System Grounding	9
Cabinet System Checkout	9
Printed Circuit Board Installation	9
Logic Board and Complete System Checkout	9
In Case of Difficulty	11
Figure 1	12
Figure 2	12
Figure 3	13
Figure 4	13
Figure 5	14
Figure 6	14
Figure 7	15
Figure 8	15
Test Mode Operation / Schematic Diagram	16

Introduction

SEGA ENTERPRISES, LTD., supported by its high electronic technology of Large Scale Integration, microprocessors, etc. and a wealth of experience, has for more than 30 years been supplying various innovative and popular game machines to the world market. This OWNER'S AND KIT INSTALLATION manual is intended to provide detailed comments together with all the necessary information covering the operation and installation of electronic assemblies, electro-mechanical assemblies, control assemblies, and spare or replacement parts for coin operated games. This manual is intended

Introduction

SEGA ENTERPRISES, LTD., supported by its high electronic technology of Large Scale Integration, microprocessors, etc. and a wealth of experience, has for more than 30 years been supplying various innovative and popular game machines to the world market. This OWNER'S AND KIT INSTALLATION manual is intended to provide detailed comments together with all the necessary information covering the operation and installation of electronic assemblies, electro-mechanical assemblies, control assemblies, and spare or replacement parts for coin operated games. This manual is intended for those who have knowledge of electricity and technical expertise in video games. Carefully read the enclosed information before starting the kit installation or troubleshooting procedures.

Handling and Installation Precautions

- During Installation:**
1. Be sure to remove power plug when working on the machine.
 2. Be sure all connections and harness routing are secure.
 3. Make sure all grounding connections are secure and properly affixed.
 4. Do not use any fuse that does not meet the specified rating.

Prevention of Counterfeiting and Conversion Labeling

To prevent counterfeit and unauthorized conversions, the following label is supplied with all authorized SEGA kit products. When handling such goods, be sure to locate and confirm the label. It is used to prevent illegal acts such as the unauthorized copying of the products and the printed circuit boards.

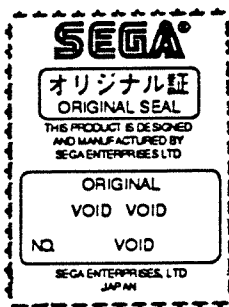

Precautions Concerning the Place of Installation

The CONVERSION KIT is intended to be installed in an indoor game cabinet. Absolutely do not install it outdoors. When installed indoors the following places mentioned below should be avoided to ensure proper operation and usage:

- Places subject to rain or water leakage, or condensation due to humidity
- In the proximity of an indoor swimming pool and/or shower
- Places subject to direct sunlight
- Places subject to heat sources from heating units, hot air, etc.
- Vicinity of highly flammable/volatile chemicals or hazardous materials
- Sloped surfaces
- Vicinity of anti-disaster facilities such as fire exits and fire extinguishers
- Places subject to any type of violent impact
- Dusty environment

System Requirements

Power Supply:

- Input voltage 90 VAC to 135 VAC 60 Hz
- + 5 volts at 6 amps
- + 12 volts at 2 amps
- Over-voltage protected at + 5.8 volts
- Current limit set at 8 amps

RFI Line Filter:

1. If a switching power supply is used:
 - Current rating of 6 amps
 - Frequency attenuation of the following:

0.15 MHz	40db
0.5 MHz	65db
1.0 MHz	65db
5.0 MHz	55db
10.0 MHz	50db
30.0 MHz	50db

2. If a linear power supply is used:
 - Current rating of 5 amps
 - Frequency attenuation of the following:

0.15 MHz	6db
0.5 MHz	19db
1.0 MHz	28db
5.0 MHz	42db
10.0 MHz	45db
30.0 MHz	50db

Miscellaneous:

- | | |
|------------------------|---|
| Line Fuse: | 4 amp 120 VAC |
| Speaker: | 8 ohms 10 watt |
| On/Off Switch: | 6 amp 120 VAC |
| Isolation Transformer: | 115 VAC primary, 115 VAC secondary, 100 Watts |
| Coin Door: | Dual coin acceptors |
| Coin Meter: | + 5 Volt DC |
| Power Cord: | Three conductor with ground |
| Color Monitor: | |
| | • Video input 1 volt to 5 volt peak-to-peak positive polarity |
| | • Sync TTL negative polarity separate horizontal and vertical |
| | • Horizontal frequency 15.750 KHz |
| | • Vertical frequency 60 Hz |
| | • Video bandwidth 12 MHz or greater |
| | • Horizontal mounted |
| | • Recommended size 19 inch |

Tools Required

- Drill
- Hole cutter 1-3/16 "
- Phillips screw driver
- Flat blade screw driver
- Small flat blade screw driver
- Scissors
- Sand paper
- Paint
- Xacto knife
- Wood patch

Cabinet Preparation

1. Remove old PCB, and all existing game harnesses.
2. Remove and disassemble the control panel.
3. Remove any side decals, monitor bezel, and marquee.
4. Using sandpaper and/or paint thinner, clean and smooth the cabinet for paint preparation. Use wood patch to fill any nicks or flaws in the cabinet.
5. Paint cabinet if required.
6. Wipe down and vacuum cabinet as necessary.

NOTE: You are building a new game, not just changing an old one. A nice, clean, and new looking conversion not only earns better, but lasts longer.

Kit Component Verification

Verify each component with the kit list provided to assure your kit is complete. If any part is missing after the inventory is taken, please contact your distributor and provide to them the following information:

1. Kit serial number
2. Part number and description of missing item/s
3. Date received

Kit List

Part Number	Quantity	Description
0002-0000	2	#6 x 3/8 P/H Phil Tek
0002-0001	4	#6 x 3/4 P/H Phil "AB" SMS
0312-0024	16	#10-24 x 1 3/4 Carr/Bolt Black
0502-0024	16	#10-24 Hexnut
0612-0024	16	#10 Split Lock Washer
0692-0024	16	#10 Flat Washer 1/2 OD
2112-0000	2	Wire Nut #18
999-0087	1	Monitor Card
999-0133	1	Owners Manual, Arabian Fight
421-5801-139	1	License Seal
999-0127	2	Side Decal
999-0086	1	Control Panel Overlay
999-0129	1	Marquee, Arabian Fight
999-0130	1	Label Sheet (See List)
		- Test, Service, Volume Sticker
		- Play Instructions
		- Action Button Labels
		- Start Button Labels
999-0047	1	FCC Plate
4750-0049	1	Volume Control 100 Ohm 10 Watt
5090-5028	2	PB Spst Switch Momentary
999-0122	4	Joy Stick, 8 Way
999-0063	4	Pushbutton, Microswitch (White)
999-0123	4	Pushbutton, Microswitch (Red)
999-0124	4	Pushbutton, Microswitch (Yellow)
JAM-0000	1	Jamma Harness
999-0094	1	I/O Harness
KR0-1721	1	Service Switch Bracket
833-8646-04	1	Game PCB, System 32 Arabian Fight

Installation Procedure

Monitor Card

1. Locate the MONITOR CARD and measure the size of existing monitor card or the required size to fit (refer to the reverse side of the monitor card for 19" or 25" monitor size option). Cut the cardboard monitor card to size. (see figure 1)
Install Play Instruction Labels horizontally across the bottom of the Card.

License Seal

2. Locate the LICENSE SEAL and place seal as shown in figure 1. Install Monitor Card on game cabinet. Note: Verify that the License Seal will be visible when the Monitor Card is installed on game cabinet.

Side Decal

3. Locate the SIDE DECALS and install on the left and right side panels of the cabinet (see figure 1). Note: A mixture of slightly soapy water can be used on the cabinet to position the Decal as desired. A squeegee may be used to remove any wrinkles in the Decal if soapy water is used.

Marquee

4. Locate the MARQUEE SHEET and measure the size of existing Marquee or required size to fit and trim the Marquee Sheet to size. Install on cabinet. (see figure 1)

Control Panel

5. Locate the CONTROL PANEL OVERLAY and measure the size required and cut the control panel overlay to fit the existing control panel.
6. Define the location of the player push buttons and joystick(s) on the control panel. (see figure 2)
7. Cut holes in control panel to locate buttons and joystick(s). See template for button and joystick. (see figure 3)
8. Install the "PLAYER START" label or labels on the control panel overlay if applicable (see figure 2)
9. Drill the control panel for the player controls as shown in figure 2.
10. Install player control button labels on the control panel overlay (see figure 2)
11. Install player pushbutton/s as required. (see figure 2)

NOTE: When buttons are securely placed and tightened in the control panel assembly, a small amount of clear RTV Silicone may be placed on two or three areas of the lock-nut to keep the switches from being unscrewed from the top of the panel. (see figure 3)

Service Switch Assembly

12. Install player/s JOYSTICK/S as required. (see figure 2)
13. Locate SERVICE SWITCH BRACKET and install two PUSH BUTTON SPST SWITCH MOMENTARY into bracket as shown in figure 4.
16. Locate VOLUME CONTROL 100 OHM 10 WATT and install into service switch bracket as shown in figure 4.
17. Locate TEST, SERVICE, VOLUME STICKER and place on the service switch bracket as shown in figure 4.
18. Locate KNOB 1/8" SHAFT and install on shaft of volume control 100 ohm 10 watt as shown in figure 4.
19. Install the Service Switch Assembly using 2 ea screws in the cabinet at either of the following locations (see figure 5):
 - On top of the steel enclosure for the Cash Box, inside the coin door.
 - Inside to the left of the coin door, mounted to the wood cabinet.

Harness Installation

20. The Game PCB is Jamma compatible for player 1 and 2. Players 3 and 4 are connected to an I/O PCB attached to the main logic pcb. . Modification of an existing Jamma harness inside the game cabinet should not be necessary. CAUTION SHOULD BE OBSERVED TO ASSURE THAT THE PIN OUTPUTS ARE CORRECT.
21. Connect the Player/s controls and buttons to the PCB..
22. Connect the T.V Monitor as shown in figure 6.
23. Connect the routed speaker wires to the speaker. Check the routing for security.
24. Connect the SERVICE SWITCH ASSEMBLY as follows: (see figure 4.)

FOR REMOTE VOLUME CONTROL OPERATION PERFORM THE FOLLOWING STEPS:

- a. Locate the 2 speaker wires which connect to pins L and 10 of the Jamma connector.
- b. Connect the wire from Pin L of the Jamma connector and one side of the speaker to one side of the volume control.
- c. Connect the wire from Pin 10 of the Jamma connector to the other side of the volume control.
- d. Connect the other side of the speaker to the center terminal of the volume control.

FOR REMOTE TEST OPERATION PERFORM THE FOLLOWING STEP:

Connect the wire from Pin 15 of the Jamma harness to one side of the Test pushbutton and connect ground to the other terminal of the pushbutton.

FOR REMOTE SERVICE OPERATION PERFORM THE FOLLOWING STEP:

Connect the wire from Pin R of the Jamma harness to one side of the Service pushbutton and then connect ground to the other terminal of the pushbutton.

**Cabinet 115 VAC
System Grounding**

24. Locate the GROUND lead (green) of the 115 volt input power Line (see figure 7). This must be connected to all components of the game system. This is a safety requirement for the players protection. This AC GROUND must be of # 18 AWG wire or larger. (see figure 7 for the proper routing of the wire)

**Cabinet System
Checkout**

25. Apply power to cabinet system and check for the following voltages. If any voltage is incorrect, remove power and correct problem before proceeding any further.
 - a. + 5 Volts on pins 3,4,C, and D of the 56 pin PCB connector.
 - b. + 12 Volts on pins 6 and F of the 56 pin PCB connector.
 - c. No voltage present on any other pins of the 56 pin PCB connector.
26. Check that the monitor has power. This can be accomplished by observing the glow of the filament inside the neck of the picture tube.
27. Check that the Marquee lamp has power.
28. Check that the system ON/OFF switch functions properly.

WARNING: PROCEED ONLY IF THE ABOVE CHECKS ARE CORRECT

PCB Installation

29. Install the logic PCB inside the cabinet (see figure 5). Use wood screws to secure the PCB through its' mounting feet.
30. Locate the Switch Setting Sheet for factory recommendations. Setting options are adjustable in the Test Mode.
31. Connect the 56 pin Jamma connector to the PCB.

NOTE: The proper orientation of the connector (see figure 8). If not connected properly, the system will not function and damage can occur to the PCB.

**Logic Board and
Complete System
Checkout**

32. Apply power to the system and observe that the logic PCB functions. If a video picture is not present proceed to "IN CASE OF DIFFICULTY" portion of this manual. When corrected, return to this point and continue.

33. Press the TEST BUTTON to enter the test menu. Individual tests can be entered by following the instructions on the Test screen.
34. Functionally test the game by:
 - a. VERIFY that coin drops register proper credit/s and the COIN METER OPERATES
 - b. VERIFY that the proper number of lives is given for each CREDIT
 - c. VERIFY that all player controls operate properly
35. Locate the Kit SERIAL NUMBER STICKER and FCC PLATE. Install on the rear of the game cabinet. (see figure 1)

In Case of Difficulty

No Raster/No Video

- Check A.C. line cord
- Check line fuse
- Check monitor brightness
- Check power switch and/or interlock switch
- Check all solder connections on line filter and transformer
- Check for proper orientation of the 56 pin PCB connector

Raster/No Video

- Check all PCB to monitor connections
- Check power supply voltage on PCB

No Video/ Game sounds can be heard

- Check monitor brightness
- Check all PCB to monitor connections

Incorrect Colors

- Monitor needs degaussing
- Check for proper wiring between PCB and monitor
- Check monitor adjustment and adjust if necessary

Wavy Picture

- Check monitor ground is properly connected to monitor
- Be certain sync inputs are properly connected to monitor
- Check horizontal hold adjustment

Vertical Roll/Horizontal Tear

- Check horizontal and/or vertical hold adjustments
- Check for proper wiring of sync from PCB to monitor

No Sound

- Check volume control potentiometer adjustment
- Check for + 12 volts on edge connector of PCB
- Check wiring from PCB to speaker
- Check speaker for low resistance between the " + " and " - " tabs

Bad Sound

- Check wiring to speaker for bad solder connections
- Check sound with another speaker

No Switch Input

- Check ground connection to switch/es
- Check wiring between PCB and switch/es for proper connection
- Check switch/es with an ohm meter to verify proper operation

Switch Operates Incorrect Function

- Check wiring between PCB and switches for proper orientation
- Check wiring for shorts between switch inputs

No Coin Meter

- Check wiring to coin meter
- Check that + 5 volts is on + side of meter
- Verify a + 5 volt meter is used

When coin switch is made and meter pulses, the screen blanks out and/or game resets

- Verify that a meter with a diode is used
- If no diode is built in meter a 1N4004 can be used across the meter. Cathode to "+" side of meter and anode to "-" side of meter.

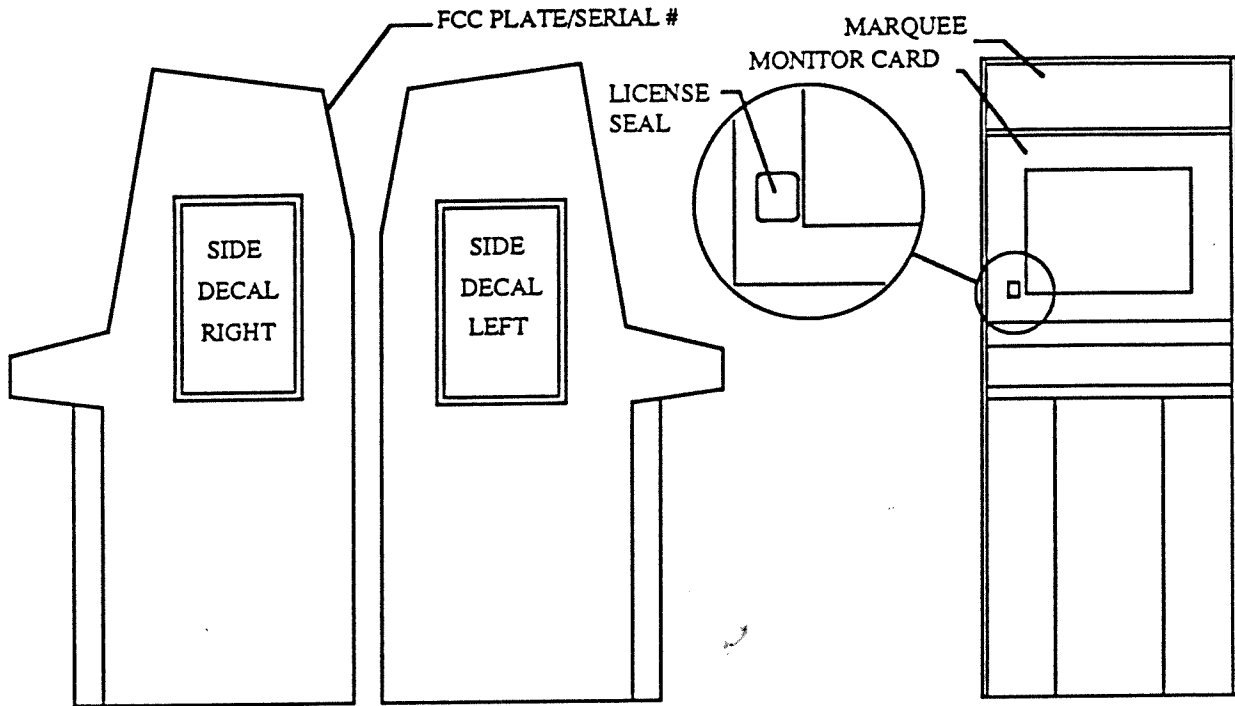

Figure 1

CONTROL PANEL TOP VIEW

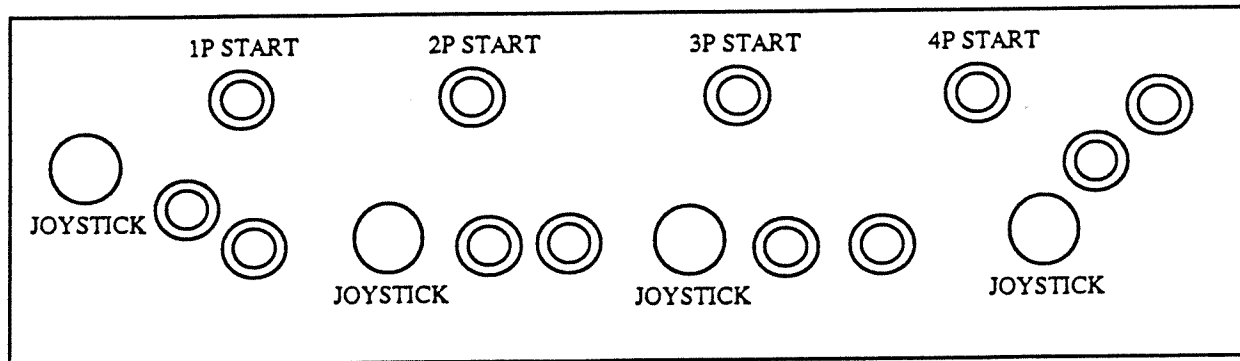

Figure 2

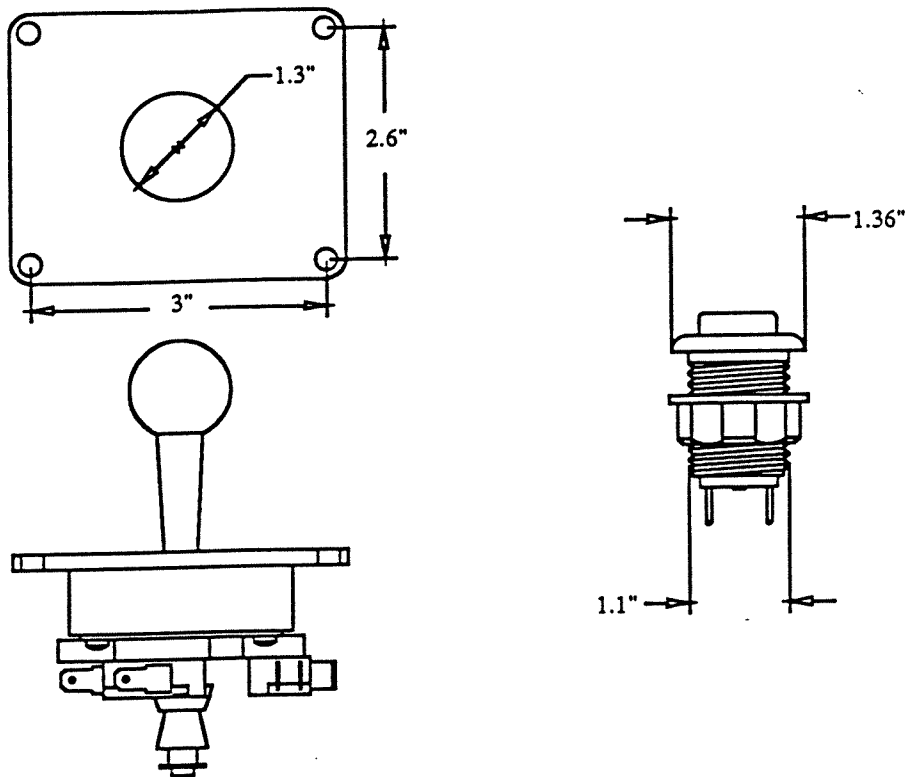
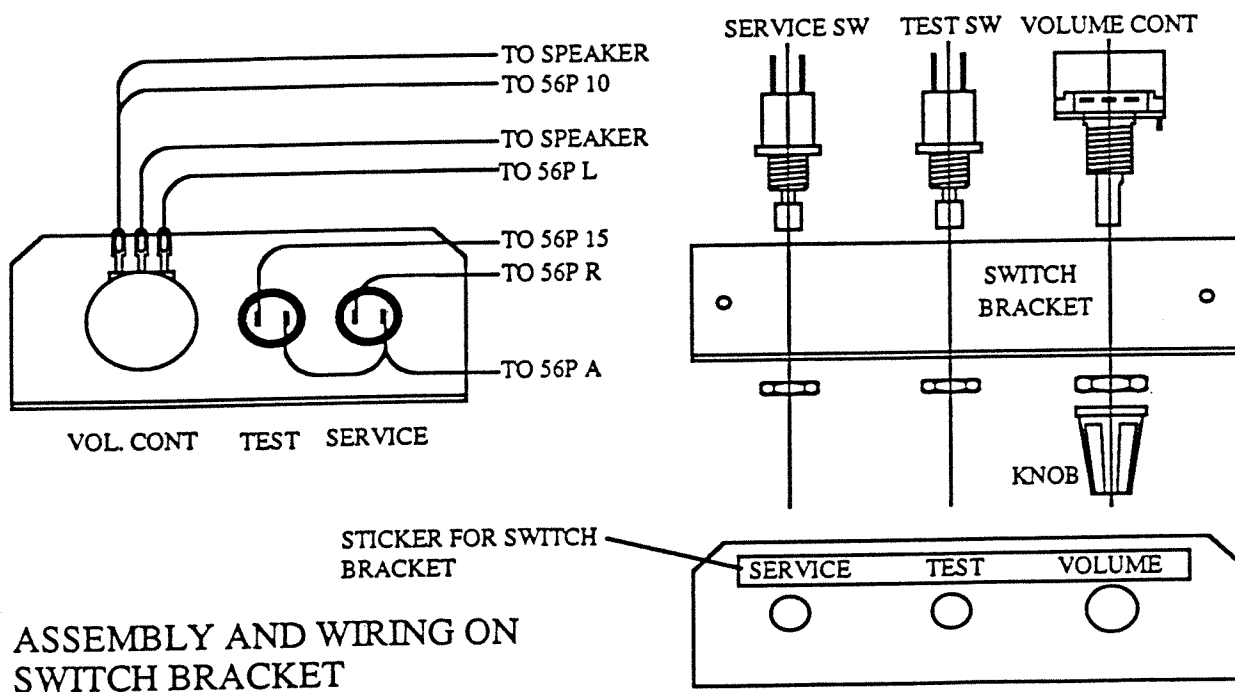

FIGURE 3



ASSEMBLY AND WIRING ON SWITCH BRACKET

FIGURE 4

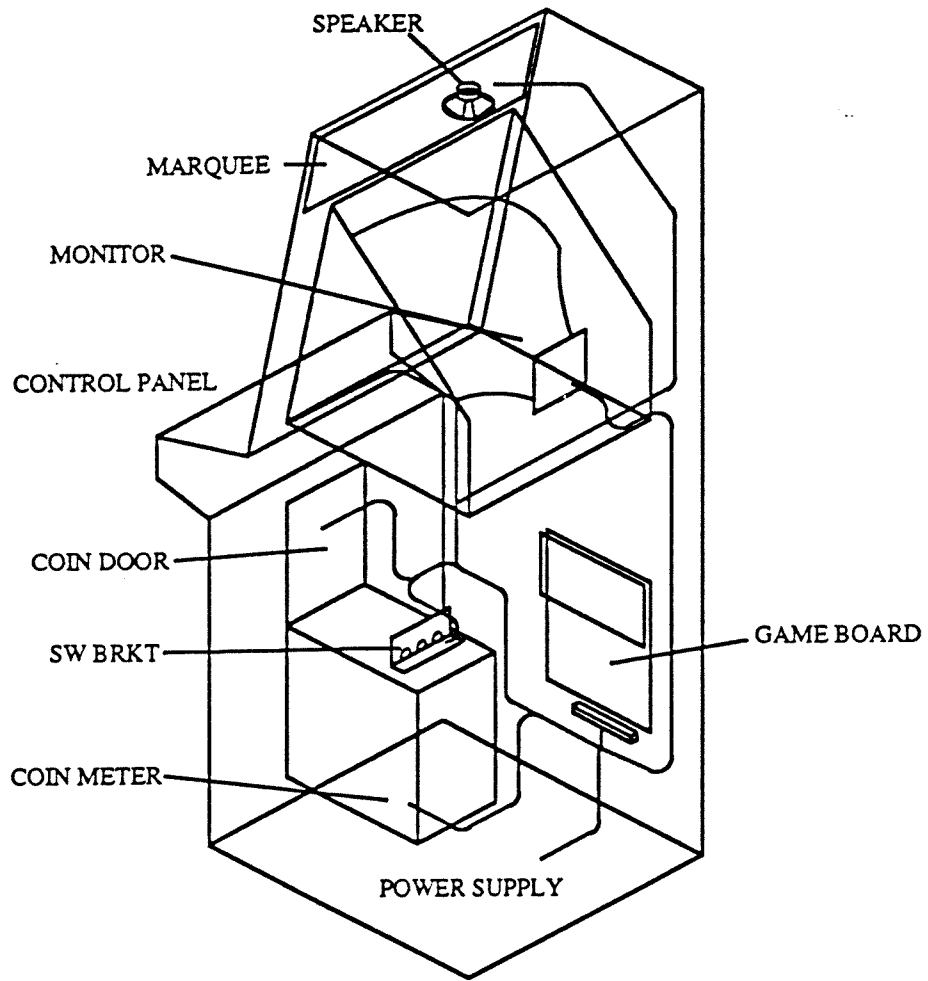

FIGURE 5

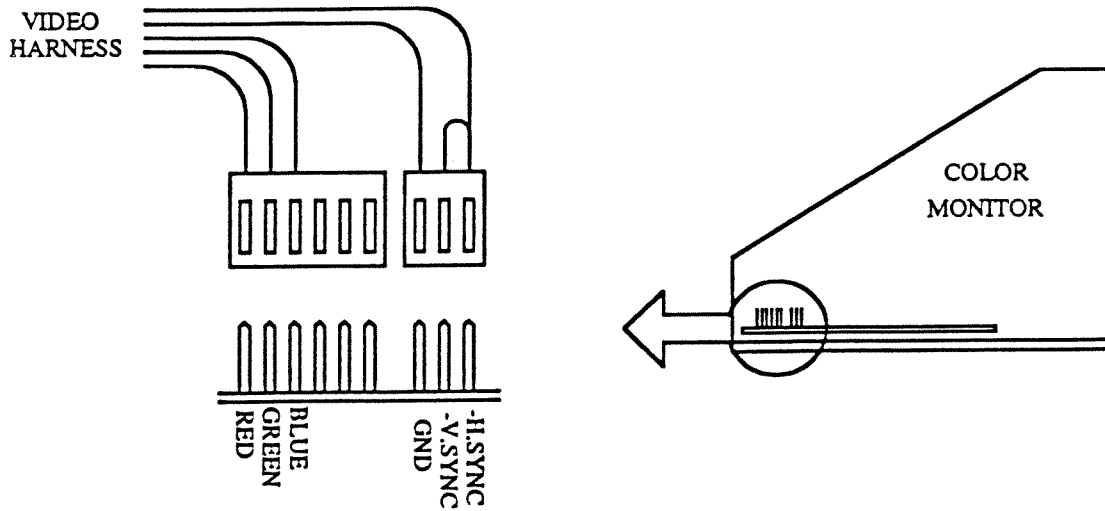

FIGURE 6

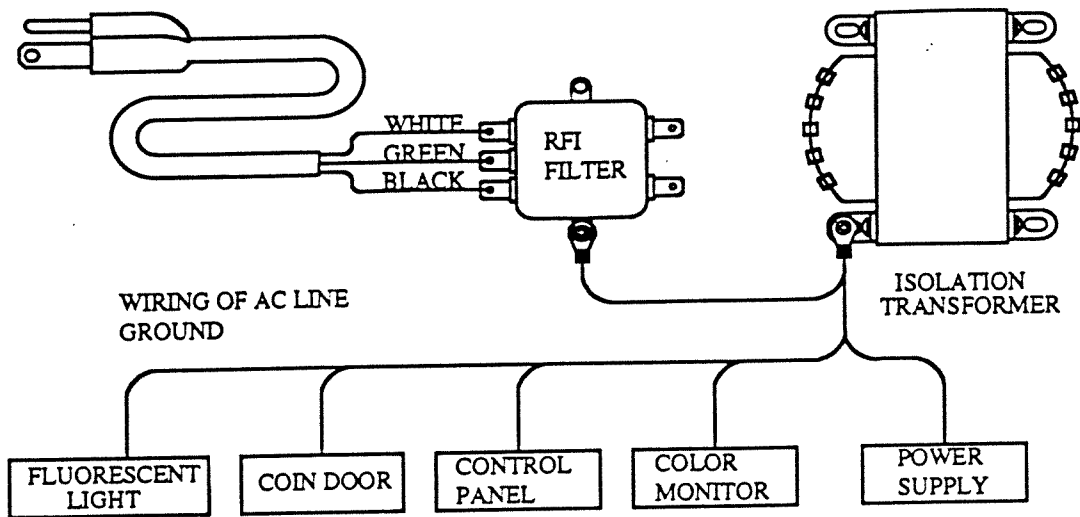

Figure 7

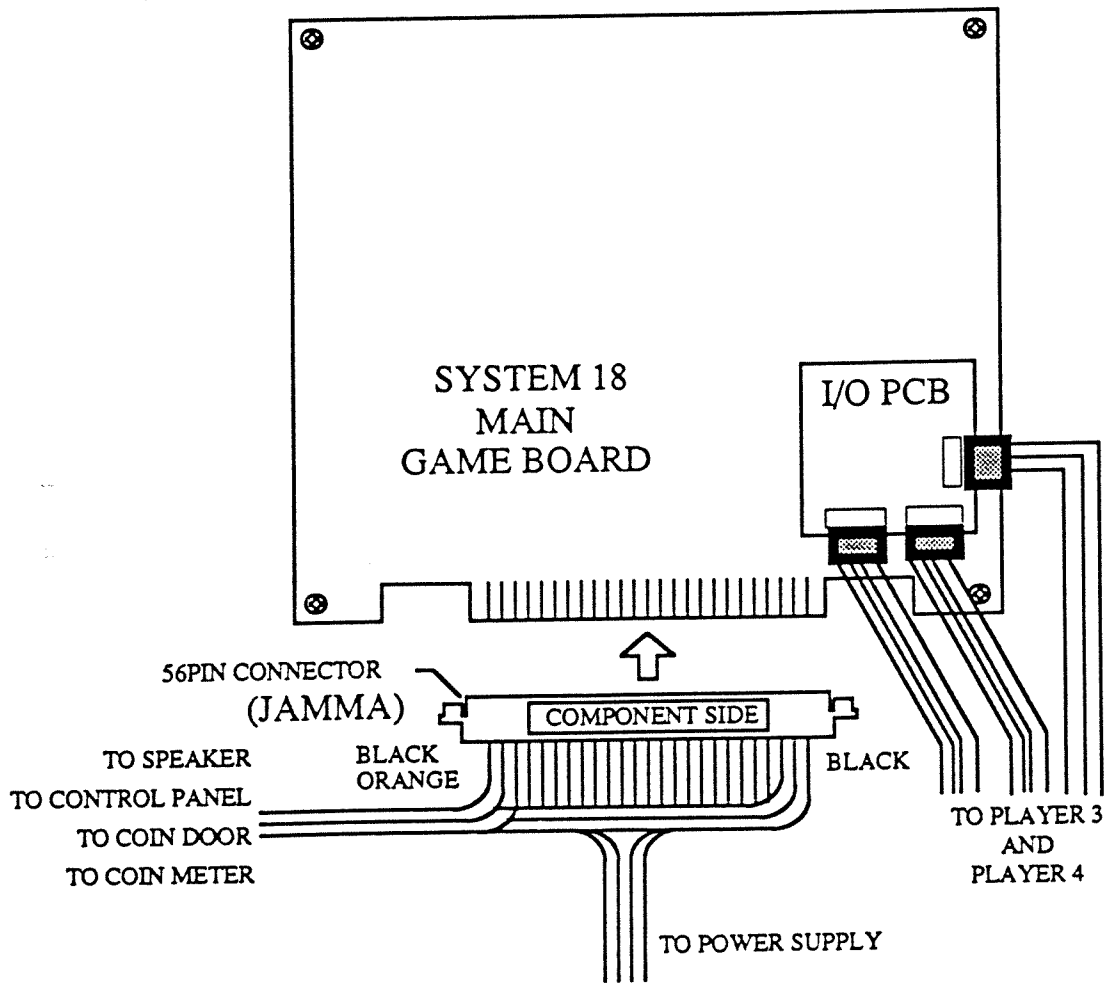

FIGURE 8

TEST MODE

The test operation of this game allows you to verify operation of the game memory, input, sound, CRT, and game assignments. The test mode also includes coin assignments, and bookkeeping functions.

Selection of Test Items:

1. Push the TEST SW to cause the following TEST ITEM MENU to appear:

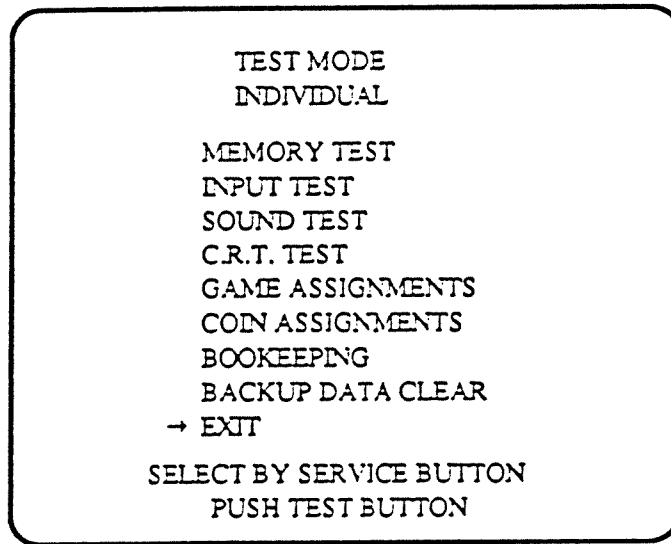

2. When you push the service switch, the arrow (→) will move to the next item on the menu.
3. Press the Test Button to perform the selected function.

Memory Test. When this item is selected, a list of Integrated Circuits will appear. Each item will display "Good" or "Bad" to indicate whether or not the IC is functioning properly. If "Bad" appears, it indicates a malfunctioning IC.

```

MEMORY TEST

<ROM>
IC9 GOOD IC8 GOOD
IC18 GOOD
<RAM>      IC16 GOOD
IC36 GOOD IC37 GOOD
IC61 GOOD IC62 GOOD
IC63 GOOD IC64 GOOD
IC65 GOOD IC66 GOOD
IC68 GOOD IC69 GOOD
IC70 GOOD IC71 GOOD
IC74 GOOD IC75 GOOD

PUSH TEST BUTTON TO EXIT

```

Input Test. This test indicates the condition of each switch and potentiometer. To test a switch, operate it. When the switch is in good operating condition, the "Off" will change to "On". If it does not change, it indicates a malfunctioning switch.

```

INPUT TEST

PLAYER  1P  2P  3P  4P

  UP  Off  Off  Off  Off
DOWN  Off  Off  Off  Off
RIGHT Off  Off  Off  Off
  LEFT Off  Off  Off  Off
ATTACK Off  Off  Off  Off
  JUMP Off  Off  Off  Off
  START Off  Off  Off  Off
   CON  Off  Off  Off  Off

SERVICE-OFF      TEST-OFF

PUSH TEST BUTTON TO EXIT

```

Sound Test. The sound test indicates whether or not the sound in each category is working properly or not. Select the item using the Service Button and then push the Test Button.

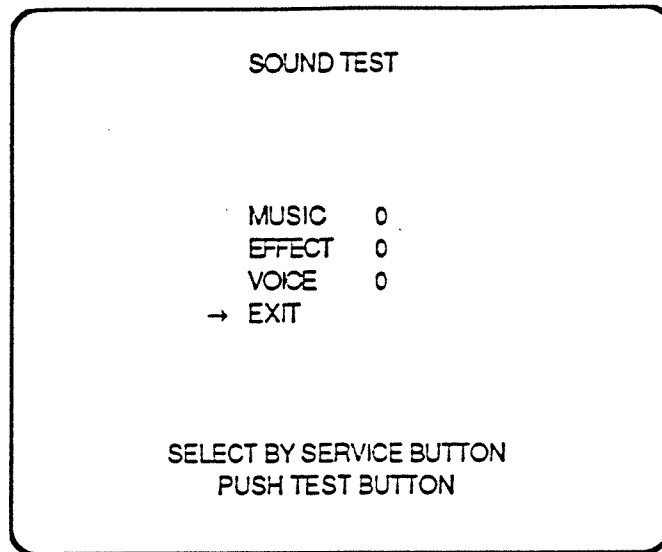

RGB Color Check. The CRT test allows you to adjust the color of the monitor. The color becomes brighter from left to right.

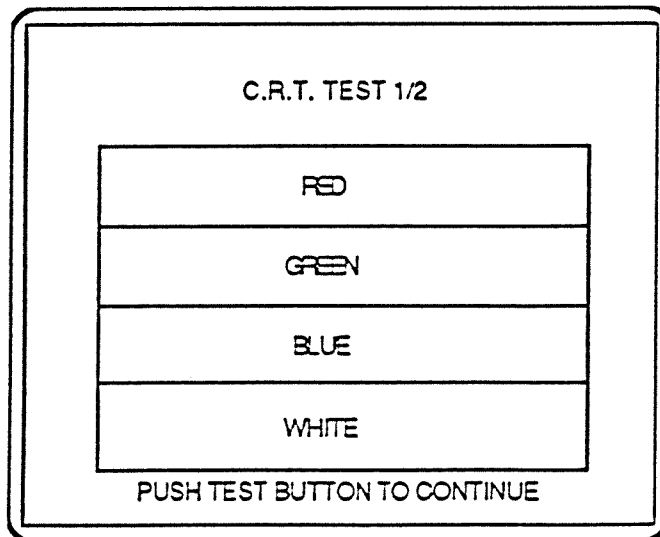

C.R.T. Test. View the image and make sure that all corners are straight. If the corners are not straight, make the necessary adjustments.

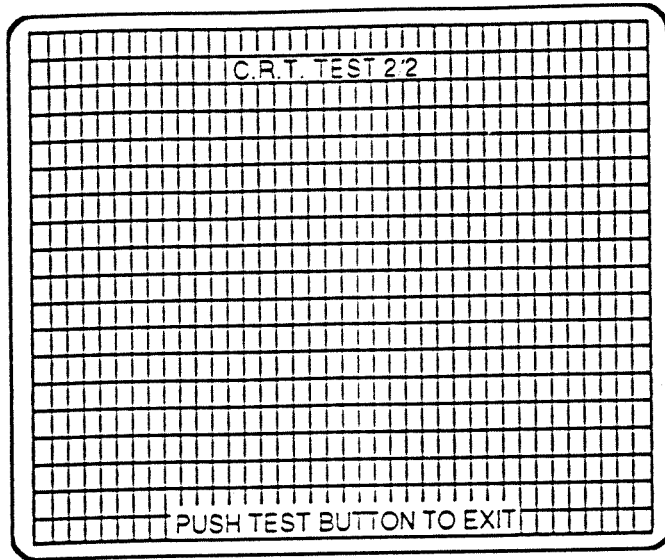

Game Assignments.

The monitor allows you to adjust game assignments as follows:

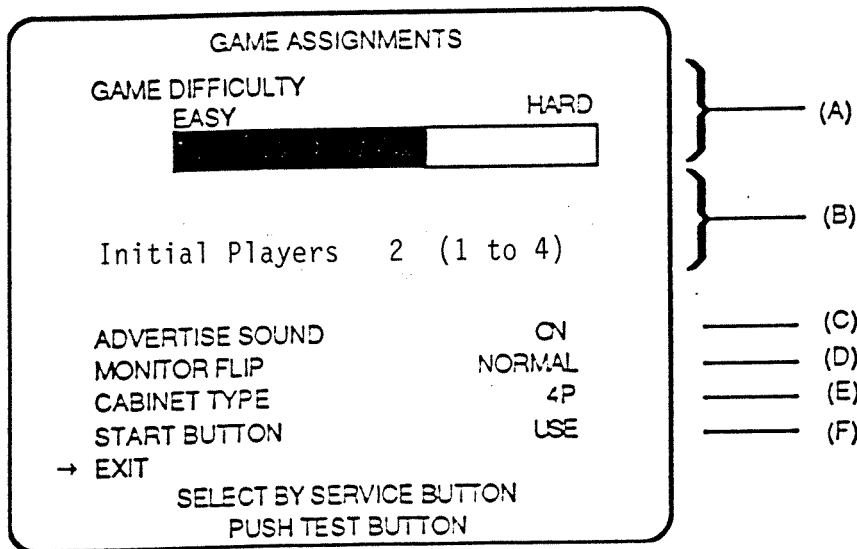

- A. Game Difficulty: Values range from 1-16. The higher the number, the more difficult the game play.
- B. Initial Players: Sets the number of players allotted. The same number applies to both cases of starting and continuing (Min. 1, to Max. 5, with the standard setting being 2).

- C. Advertise Sound: Allows you to turn the advertising sound on or off.
- D. Monitor Flip: Should be set to normal.
- E. Cabinet Type: Should be set to 4P.
- F. Start Button: Should be set to Use.

Coin Assignments.

The coin chute type is set to individual. The credit to start play is two credits. One coin per chute equals one credit per chute. Fifteen different types of coin credits can be selected. See the coin/chute setting matrix on page 15.

COIN ASSIGNMENTS	
COIN CHUTE TYPE	INDIVIDUAL
CREDIT TO START	2 CREDITS
COIN/CREDIT SETTING	#1
COIN CHUTE #1	1 COIN 1 CREDIT
COIN CHUTE #2	1 COIN 1 CREDIT
MANUAL SETTING	
→ EXIT	
SELECT BY SERVICE BUTTON AND PUSH TEST BUTTON	

Manual Setting. The coin to credit, Bonus Adder information and coin chute multiplier are displayed. Select the item by using the Service Button and then push the Test Button to perform the selected function.

COIN ASSIGNMENTS
MANUAL SETTING

COIN TO CREDIT 1 COIN 1 CREDIT
BONUS ADDER NO BONUS ADDER
COIN CHUTE MULTIPLIER
COIN 1 COIN COUNTS AS 1 COIN

1 2 3 4 5 6 7 8 9
1 2 3 4 5 6 7 8 9

CREDIT
→ EXIT

SELECT BY SERVICE BUTTON
AND PUSH TEST BUTTON

COIN/CREDIT SETTING
 (COIN CHUTE INDIVIDUAL TYPE)

SETTING #1	1 COIN	1 CREDIT
SETTING #6	1 COIN	2 CREDITS
SETTING #8	1 COIN	3 CREDITS
SETTING #9	1 COIN	4 CREDITS
SETTING #10	1 COIN	5 CREDITS
SETTING #11	1 COIN	6 CREDITS
SETTING #12	2 COINS	1 CREDIT
SETTING #15	1 COIN 2 COINS	1 CREDIT 3 CREDITS
SETTING #17	3 COINS	1 CREDIT
SETTING #18	4 COINS	1 CREDIT
SETTING #19	1 COIN 2 COINS 3 COINS 4 COINS	1 CREDIT 2 CREDITS 3 CREDITS 5 CREDITS
SETTING #21	3 COINS 5 COINS	1 CREDIT 2 CREDITS
SETTING #22	2 COINS 4 COINS 5 COINS	1 CREDIT 2 CREDITS 3 CREDITS
SETTING #24	1 COIN 2 COINS 3 COINS 4 COINS 5 COINS	1 CREDIT 2 CREDITS 3 CREDITS 4 CREDITS 6 CREDITS
SETTING #26	FREE PLAY	

MANUAL SETTINGS

COIN TO CREDIT	1 COIN	1 CREDIT
	2 COINS	1 CREDIT
	3 COINS	1 CREDIT
	4 COINS	1 CREDIT
	5 COINS	1 CREDIT
	6 COINS	1 CREDIT
	7 COINS	1 CREDIT
	8 COINS	1 CREDIT
	9 COINS	1 CREDIT

BONUS ADDER	NO BONUS ADDER
	2 COINS GIVE 1 EXTRA COIN
	3 COINS GIVE 1 EXTRA COIN
	4 COINS GIVE 1 EXTRA COIN
	5 COINS GIVE 1 EXTRA COIN
	6 COINS GIVE 1 EXTRA COIN
	7 COINS GIVE 1 EXTRA COIN
	8 COINS GIVE 1 EXTRA COIN
	9 COINS GIVE 1 EXTRA COIN

COIN CHUTE #1 MULTIPLIER	1 COIN COUNTS AS 1 COIN
	1 COIN COUNTS AS 2 COINS
	1 COIN COUNTS AS 3 COINS
	1 COIN COUNTS AS 4 COINS
	1 COIN COUNTS AS 5 COINS
	1 COIN COUNTS AS 6 COINS
	1 COIN COUNTS AS 7 COINS
	1 COIN COUNTS AS 8 COINS
	1 COIN COUNTS AS 9 COINS

COIN CHUTE #2 MULTIPLIER	1 COIN COUNTS AS 1 COIN
	1 COIN COUNTS AS 2 COINS
	1 COIN COUNTS AS 3 COINS
	1 COIN COUNTS AS 4 COINS
	1 COIN COUNTS AS 5 COINS
	1 COIN COUNTS AS 6 COINS
	1 COIN COUNTS AS 7 COINS
	1 COIN COUNTS AS 8 COINS
	1 COIN COUNTS AS 9 COINS

Coin chute #3 and coin chute #4 multipliers are the same as for #1 and #2 above.

Bookkeeping 1/2. The Coin Chutes #1 through #4 are displayed with the total number of coin drops recorded per chute. The total of all four chutes is recorded under Total Coin. Coin Credits are displayed and the number of times the service switch has been used to gain credits is also recorded. The total of both types of credits are recorded under Total Credit.

Number of Games: displays the number of times the game has been played. Total Operating time is displayed in days, hours, minutes and seconds. The total game playing time is displayed in a like fashion. Average game length , Longest game time, and Shortest game time are displayed in hours, minutes and seconds. The utilization factor is displayed as a percentage. To continue, push the Test Button.

BOOKKEEPING 1/2	
COIN CHUTE #1	0
COIN CHUTE #2	0
COIN CHUTE #3	0
COIN CHUTE #4	0
TOTAL COINS	0
COIN CREDITS	0
SERVICE CREDITS	0
TOTAL CREDITS	0
NUMBER OF GAMES	0
TOTAL OP. TIME	0d 0h 0m 0s
TOTAL GAME TIME	0d 0h 0m 0s
AVERAGE GAME TIME	0h 0m 0s
LONGEST GAME TIME	0h 0m 0s0m 0s
SHORTEST GAME TIME	0h
UTILIZATION FACTOR	0.0%
PUSH TEST BUTTON TO CONTINUE	

Scoring information is displayed below. The average score, highest score, and the lowest score ranges are also displayed. To exit, push the Test Button.

BOOKKEEPING 2/2	
Time Histogram	
0m00s-0m29s	0
0m30s-0m59s	0
1m00s-1m29s	0
1m30s-1m59s	0
2m00s-2m29s	0
2m30s-2m59s	0
3m00s-3m29s	0
3m30s-3m59s	0
4m00s-4m29s	0
4m30s-4m59s	0
5m00s-9m59s	0
OVER 10m00s	0
AVERAGE SCORE	0
HIGHEST SCORE	0
LOWEST SCORE	0
PUSH TEST BUTTON TO EXIT	

If you wish to delete all backup bookkeeping data, simply select YES and push the Test Button. Otherwise, select No and push the Service Button.

BACKUP DATA CLEAR	
YES	
→ NO	
SELECT BY SERVICE BUTTON AND PUSH TEST BUTTON	

4 PLAYER TYPE

PIN ASSIGNMENT

JST 10P
(I/O BD CN 2)

1	3P UP
2	3P DOWN
3	3P LEFT
4	3P RIGHT
5	GND
6	3P ATTACK
7	3P JUMP
8	(NOT USED)
9	(NOT USED)
10	GND

JST 11P
(I/O BD CN 3)

1	4P UP
2	4P DOWN
3	4P LEFT
4	4P RIGHT
5	GND
6	4P ATTACK
7	4P JUMP
8	(NOT USED)
9	(NOT USED)
10	GND
11	

JST 05P
(I/O BD CN4)

1	3P START
2	4P START
3	(NOT USED) <COIN 3 (2P COIN)>
4	(NOT USED) <COIN 4 (1P COIN)>
5	GND

(JAMMA)

COMPONENT SIDE

SOLDER SIDE

GND	1	A	GND
GND	2	B	GND
+5V	3	C	+5V
+5V	4	D	+5V
(NOT USED)	5	E	(NOT USED)
+12V	6	F	+12V
KEY (NOT USED)	7	H	KEY (NOT USED)
COIN METER 1	8	J	COIN METER 2
(NOT USED)	9	K	(NOT USED)
SPEAKER (+)	10	L	SPEAKER (-)
(NOT USED)	11	M	(NOT USED)
RED	12	N	GREEN
BLUE	13	P	SYNC
GND (SYNC)	14	R	ALL SERVICE
TEST	15	S	(NOT USED)
<4P COIN> COIN 1	16	T	COIN 2 <3P COIN>
1P START	17	U	2P START
1P UP	18	V	2P UP
1P DOWN	19	W	2P DOWN
1P LEFT	20	X	2P LEFT
1P RIGHT	21	Y	2P RIGHT
1P ATTACK	22	Z	2P ATTACK
1P JUMP	23	a	2P JUMP
(NOT USED)	24	b	(NOT USED)
(NOT USED)	25	c	(NOT USED)
(NOT USED)	26	d	(NOT USED)
GND	27	e	GND
GND	28	f	GND

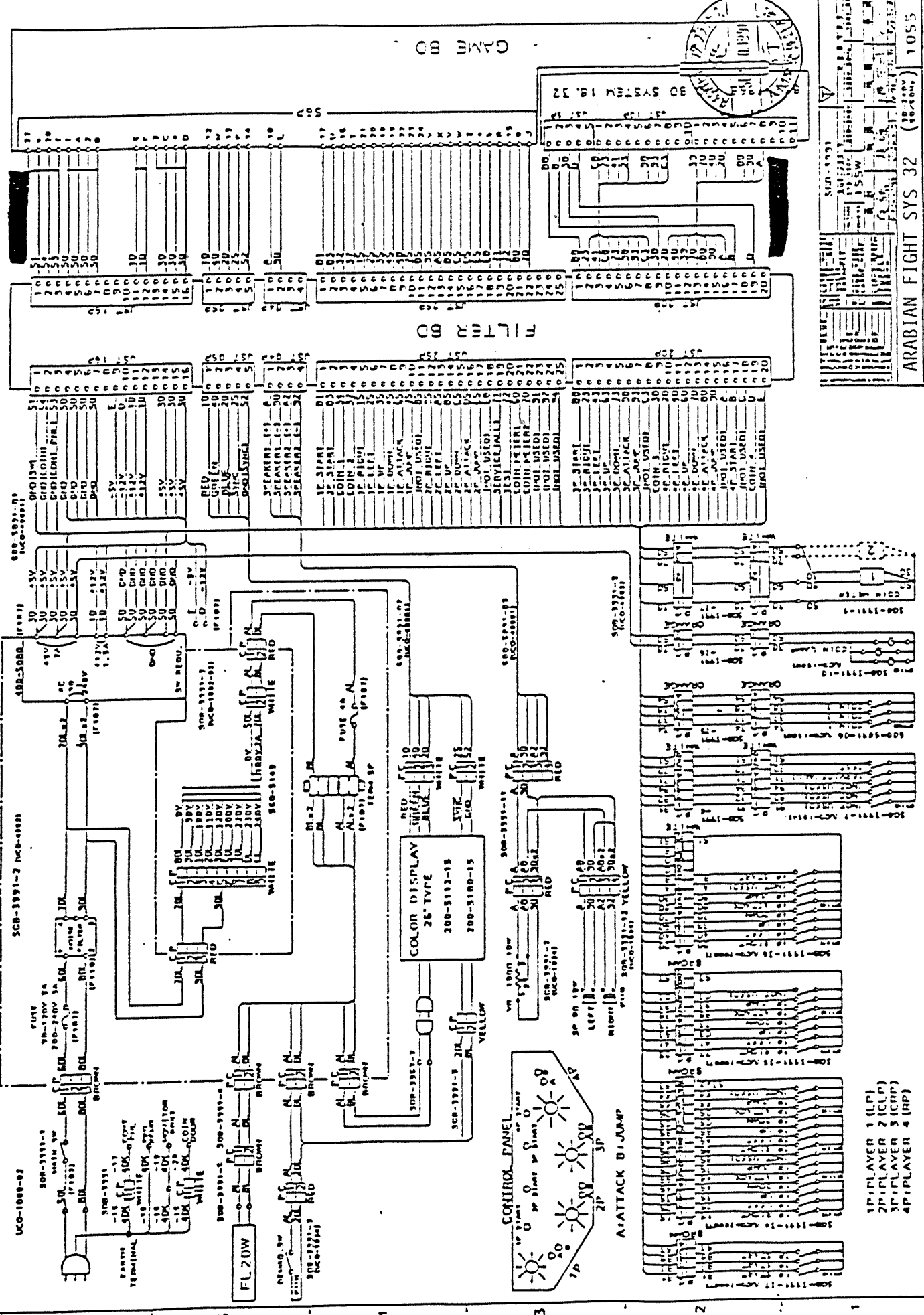

6
5
4
3
2
1

3P PLAYER 1 (LP)
3P PLAYER 2 (LP)
3P PLAYER 3 (RP)
3P PLAYER 4 (RP)

ARABIAN FIGHT SYS 32 (REV. 09-58) 1055

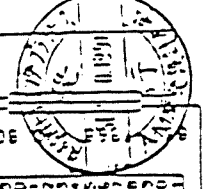

GAME BD

FILM 2 BD

