

CANDY SHOP
(DOCUMENTATION)

GRAYHOUND ELECTRONICS, INC.

1915 SWARTHMORE AVENUE LAKEWOOD, NJ 08701
TOLL FREE ~~1-800-222-0491~~ ~~908-370-8500~~ FAX 908-370-7884

CANDY SHOP

DIPSWITCHES

1
ON
OFF
ON
OFF

2
ON ——— 1 CREDIT = \$2.00
ON ——— 1 CREDIT = \$1.00
OFF ——— 1 CREDIT = .50 CENTS
OFF ——— 1 CREDIT = .25 CENTS

3
ON ——— 3 CREDITS PER \$1.00 USE 50 CENT SETTING
OFF ——— 1 CREDIT PER QUARTER

4
ON ——— WALTZ AS ATTRACT SONG
OFF ——— STING AS ATTRACT SONG

5
ON ——— 3 MINUTES BETWEEN ATTRACT TUNES
OFF ——— 1 MINUTES BETWEEN ATTRACT TUNES

6
ON ——— ENABLE TICKET DISPENSER
OFF ——— DISABLE TICKET DISPENSER

7
ON ——— DISABLE ATTRACT TUNE
OFF ——— ATTRACT SONG ENABLED

8
ON ——— SELFTEST
OFF ——— NORMAL PLAY

***** ERROR CODES *****

88-01 ——— PROBLEM WITH UP SWITCH, UP PLATE STUCK,
OR BOARD PROBLEM
99-01 ——— VEND DETECTOR BLOCKED
99-11 ——— TICKET DISPENSER JAMMED OR EMPTY
11-11 ——— SECURITY ERROR

INTRODUCTION

Congratulations!, on the purchase of your CANDY SHOP CRANE. We suggest that you read this owner's manual very carefully to become familiar with the CANDY SHOPS operations and features. This manual explains in simple easy to understand steps how to install and use your CANDY SHOP CRANE.

Copyright (C) 1994 GEI. All rights reserved.

INSTALLATION

This unit should only be plugged into a properly wired 110/120 AC outlet. If an extension cord is necessary it must be a 3 wire heavy duty utility cord. Unlock the two locks at the top left and top right corners of the CANDY SHOPS cabinet and slide the front plexi glass out. Remove bridge from the box on the inside of the cabinet and place the bridge on the two rails at the top of the cabinet. Open the front coin door before turning the unit on and check the plug in connectors on the pc boards in case one has come loose in shipping.

OPERATIONS

POWER UP, This occurs when the CANDY SHOP is turned on. A DATE CODE flashes on the displays. This date code shows the revision date of the software. Once the DATE CODE has been shown, the bridge is returned to the home position if it is not already there. When the bridge is returned to the home position the CANDY SHOP enters the ATTRACT MODE.

ATTRACT MODE, While in this mode the credit and time display are flashing back and forth. During the ATTRACT MODE it is possible to have an attract tune play. This will only occur if dipswitch #7 is in the OFF ~~on~~ position. Dipswitch #4 is used to select 1 of the 2 attract tunes, the tune will play every 1 or 3 minutes

depending on how dipswitch #5 is set. As soon as money is inserted it is recorded on the mechanical credit meter and then The ATTRACT MODE is terminated and PLAY MODE begins.

PLAY MODE, depending on how dipswitches #1 and #2 are set determines how much each play costs, either 25 cents, 50 cents, \$1.00 or \$2.00. The appropriate amount of plays is shown in the PLAYS display, each play is 15 seconds long and is shown in the SECONDS display which is the bottom display. The seconds starts counting down as soon as the joystick is moved in any direction. If the drop button is not pressed by the time the second timer reaches zero, the claw will automatically drop and close then return to the home position. The claw then opens up, if a piece of plush falls past the WIN DETECTOR, a win tune is played and the win mechanical meter is incremented. If there is no win detected then the play is replayed from the start. Once all plays are gone the CANDY SHOP will go back into the ATTRACT MODE.

SELFTEST MODE

ENTERING SELFTEST, to enter SELFTEST MODE turn CANDY SHOP CRANE off, if it is not already off. Then put dipswitch #8 on and dipswitches #1-#7 off. Next turn the CANDY SHOP on, now it is in SELFTEST MODE. Selecting the different test options is done by turning dipswitches #1-#4 on one at a time. Switch #8 must stay on to keep the unit in SELFTEST MODE.

NOTE: only 1 of the first 4 switches can be on at any given time...switches 5,6,7 should always remain in the off position during the SELFTEST.

DISPLAY TEST, to test the PLAY and SECONDS display segments place dipswitch #1 on. Both digits in the PLAY display will count from zero to 9 and then both digits in the SECONDS display will count from zero to 9. This test will continue until dipswitch #1 is turned off.

TEST ALL, this test is used to isolate switch input and output problems - place dipswitch #2 on. This test will continue until dipswitch #2 is turned off.

DESCRIPTION OF TEST ALL, as the joystick is moved in any direction the corresponding number shown in the following table will be displayed in the PLAYS display. The number that is displayed shows that the switch closure on the joystick was good. As the joystick is held in that position the bridge moves in that direction until the limit switch for that direction is hit. The limit switches number from the table are displayed in the SECONDS display. This shows that the limit switch has closed and is good. The claw can then be dropped by pressing the button on top of the joystick. The tension switch and up switch can be monitored on the SECONDS display as the claw drops down then comes back up. The WIN DETECTOR can be tested by blocking the beam in the prize shoot with your hand. The corresponding number from the table will be shown in the PLAY display. If the coin switch on the coin mech is held closed, the lockout will engage and each of the mechanical meters (PLAYS and WIN) are incremented by 1. If dipswitch #6 is on a ticket is also dispensed at this time.

AUTO BRIDGE TEST, can be entered by turning dipswitch #3 on and will continue until dipswitch #3 is turned off.

DESCRIPTION OF AUTO BRIDGE TEST, with the SECONDS counter starting at 15 seconds the bridge will move from front to back until the seconds counter counts down to 7 seconds. At this point the bridge will start moving from left to right until the seconds counter counts down to 0. Then the claw will drop close and move upwards until the black plate is reached and the upswitch closes. Now the bridge returns to the home position and the test repeats from the start.

SOUND TEST, can be entered by turning dipswitch #4 on. This test will continue until dipswitch #4 is turned off.

DESCRIPTION OF SOUND TEST, sound test will play each of the attract tunes along with the win tune.

CLOSED SWITCH	NUMBER SHOWN COIN DISPLAY	LIMIT SWITCHES	NUMBER SHOWN TIME DISPLAY
---------------	------------------------------	----------------	------------------------------

JOY BACK	1	BACK LIMIT SWITCH	1
JOY FORWARD	2	FORWARD LIMIT SWITCH	2
JOY RIGHT	3	RIGHT LIMIT SWITCH	3
JOY LEFT	4	LEFT LIMIT SWITCH	4
DROP BUTTON	5	UP LIMIT SWITCH	5
(NOT USED)	6	DOWN LIMIT SWITCH	6

COIN SWITCH	7		
DETECTOR INPUT	8		
TICKET SWITCH	9		
TILT SWITCH	10		

CRANE ENHANCEMENTS SOUND, WIN METER, DETECTOR

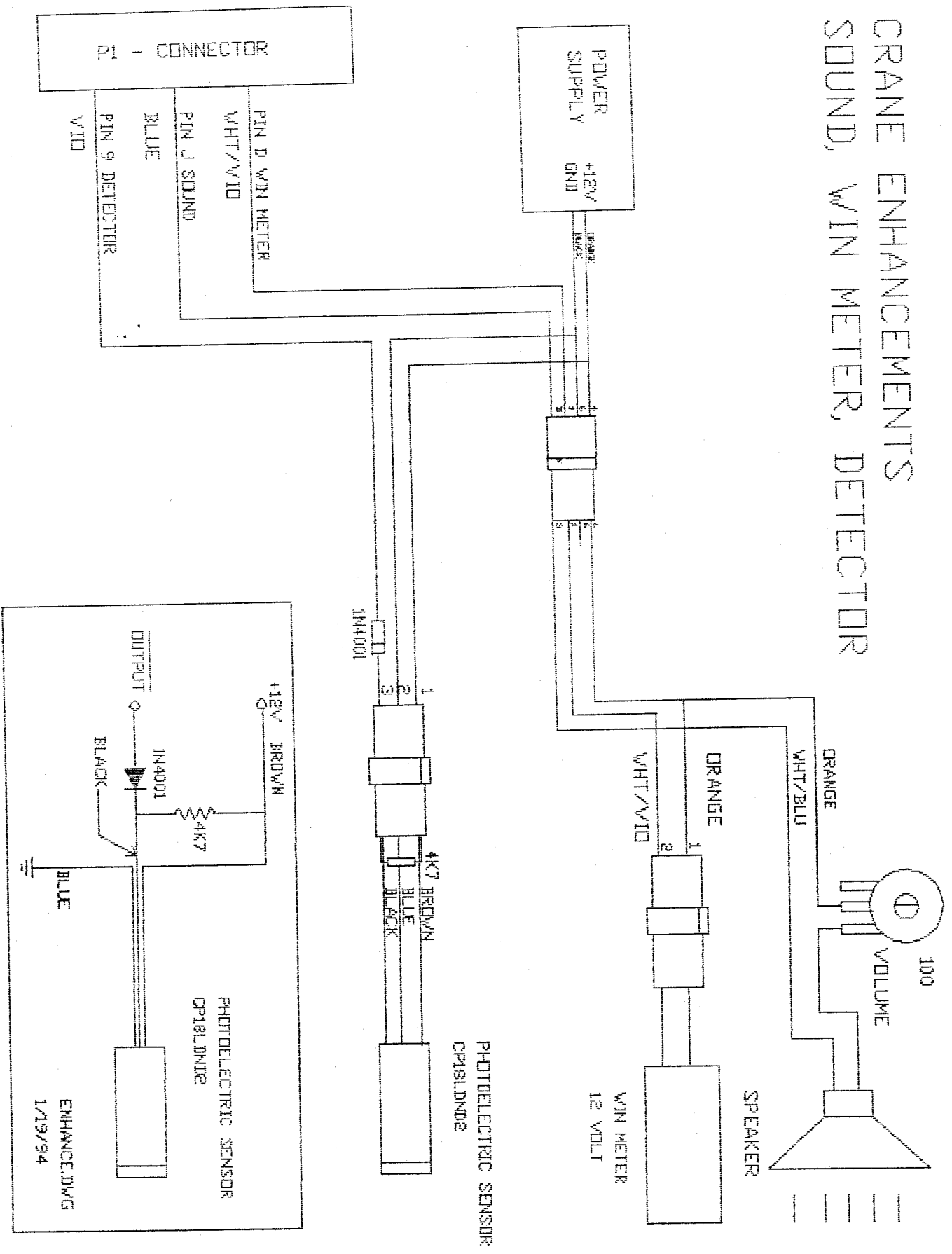

CRANE CPU BOARD

INTER-CONNECTION TO CONTROL BOARD

			12V	1	2	12V		
			5V	3	4	5V		
STICK-BUTTON		GROUND		5	6	GROUND		
L L-R BUT	P1-3	IN2-0		7	8	OUT1-7 to U1-5	U1-12 to P1-C,	COIN METER
R F-B BUT	P1-4	IN2-1		9	10	OUT1-6 to U1-6	U1-11 to P1-D,	PLUSH METER
FORWARD	P1-5	IN2-2		11	12	OUT1-5 to U1-7	U1-12 to P1-E,	LOCKOUT 1
BACK	P1-6	IN2-3		13	14	OUT1-4 to U2-1	U2-10 to P1-F,	LOCKOUT 2
CLAW	P1-7	IN2-4		15	16	OUT1-3 to U2-2	U2-15 to P1-H	COUPON METER
COUPON SW	P1-8	IN2-5		17	18	OUT1-2 to U2-3	U2-14 to P1-J	
	P1-9	IN2-6		19	20	OUT1-1 to U2-4	U2-13 to P1-K,	F-P LIGHT
COIN SW	P1-10	IN2-7		21	22	OUT1-0 to U2-5	U2-12 to P1-L,	L-R LIGHT
		GROUND		23	24	GROUND		
	P1-11	IN3-0		25	26	OUT2-7 to U2-3	U2-10 to P1-M	
	P1-12	IN3-1		27	28	OUT2-6	RELAY #7 P3-9	LEFT
DN-SW	P3-K	IN3-2		29	30	OUT2-5	RELAY #6 P3-8	RIGHT
UP-SW	P3-J	IN3-3		31	32	OUT2-4	RELAY #5 P3-7	FORWARD
BE-SW	P3-H	IN3-4		33	34	OUT2-3	RELAY #4 P3-6	BACK
FW-SW	P3-F	IN3-5		35	36	OUT2-2	RELAY #3 P3-5	UP
RT-SW	P3-E	IN3-6		37	38	OUT2-1	RELAY #2 P3-4	DOWN
LF-SW	P3-D	IN3-7		39	40	OUT2-0	RELAY #1 P3-3	CLAW

INTER-CONNECTION TO DISPLAY BOARD

		5V	1	2	5V	
		OUT3-0	3	4	OUT4-7	
		OUT3-1	5	6	OUT4-6	
		OUT3-2	7	8	OUT4-5	
TIME		OUT3-3	9	10	OUT4-4	CREDIT
DISPLAY		OUT3-4	11	12	OUT4-3	DISPLAY
		OUT3-5	13	14	OUT4-2	
		OUT3-6	15	16	OUT4-1	
		OUT3-7	17	18	OUT4-0	
		GROUND	19	20	GROUND	

CRANE RELAY BOARD

POWER IN CONNECTOR J1

?	1	AC HOT
?	2	AC COMMON
	3	LEV-NO
ORANGE	4	+12 VOLT
RED	5	+5 VOLT
	6	AC
	7	AC
BLACK	8	GROUND
BLACK	9	GROUND

LEFT CONNECTOR P1

(JOY STICK)	(BUTTONS)	TOP	BOTTOM
	BLK	GROUND	1 A GROUND
		NC	2 B NC
LEFT	BRN L-R But	IN2-0	3 C OUT1-7 Coin Meter WH/ORG
RIGHT	RED F-B But	IN2-1	4 D OUT1-6 Plush Meter
FORWARD		IN2-2	5 E OUT1-5 Coin Lock out
BACK		IN2-3	6 F OUT1-4 Coin Lock out
STOP		IN2-4	7 H OUT1-3 LATCH CLEAR (GUMBALL ONLY)
	Coupon Switch	IN2-5	8 J OUT1-2 COUPON MOTOR
	Plush Detector	IN2-6	9 K OUT1-1 F-B Light WH/RED
	BLU Coin SW	IN2-7	10 L OUT1-0 L-R Light WH/BRN
		IN3-0	11 M OUT2-7
		IN3-1	12 N 12 Volt OUT ORG

RIGHT CONNECTOR P3

TOP	BOTTOM
BLK Ground	A 1 Ground
GRY AC Com.	F 2 AC Com.
ELACK Ground	C 3 RLY#1 CLAW
WH/VIO LEFT	D 4 RLY#2 DOWN
WH/BLU RIGHT	E 5 RLY#3 UP
WH/GRN FWARD	F 6 RLY#4 BACK
WH/YLW BACK	H 7 RLY#5 FWARD
WH/ORG UP	J 8 RLY#6 RIGHT
WH/RED DOWN	K 9 RLY#7 LEFT
	L 10

BLK
 GRY ±
 BRN ±
 RED ±
 ORANGE AC TO
 YELLOW MOTORS
 GREEN /
 BLUE /
 VIOLET /

CLAW BOARD ADJUSTMENT

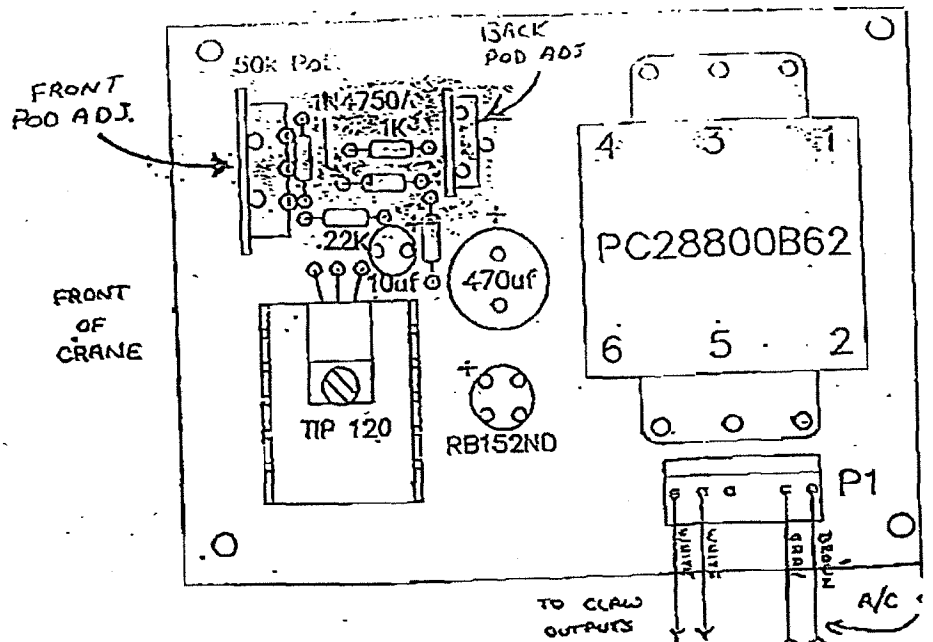

FINE TUNING WITH VOLT METER

CONNECT LEADS HERE

First, you must acquire an electric meter. You do not need expensive or elaborate equipment, a simple digital readout available at Radio Shack will be the easiest to read and use.

If you already own a regular model that's fine too!

Using a regular needle display meter, set the voltage at 15volts DC current. Open the service door, as you look at the small board to your left, you will notice two adjustable pods, a front pod and one right behind it. These two pods work in conjunction with one another and must be fine tuned as you would the carburetor in a car.

To the right of the pods you will see a plastic connector (one way snap in) with wires sticking straight up. Looking front to back you will notice the first two wires are white.

In the small hole where the first white wire sits, put the RED lead from your electric meter. This might be a little tight, but it must be seated with the first white wire.

Next, in the 2nd hole right behind the first wire place the BLACK lead. Make sure both are securely in place!

Now turn both pods completely off by turning them both counter clockwise till they stop.

With the crane coiled up and ready start playing the crane as you would normally.

Let the claw drop; now on its return up and to the front is the only time you may do any adjusting of the pods!!

Start with the rear pod and turn it to the right until it registers 10 on the 15volt scale.

This may take a couple of plays to get it as close to being on 10 as possible.

Now with the crane still returning to home position adjust the front pod another 2 increments, so that you have a total read out of 12 on your scale. 10 on the rear pod and 2 more on the front!

Note: Depending on location and the volume of business you are doing you may fluctuate the front pod setting to please your needs. Moving the front pod 1 more increment will let your'e players win a little more (a total of 15 on your'e scale).

If you follow the above steps, whether you are running 1 or 200 cranes, you will be working on a good payout percentage on all your cranes, about 25 to 33 percent depending which of the above settings you choose.

If you are using a direct digital readout meter don't worry about the 15 volt scale, just set your meter to DC volts and use the direct reading.

Step 6: Now that you have a perfectly tuned machine you are ready to fill it with plush and install it on location. Your first time in a location and the appearance of you're crane is important. Plainly what we call the FLASH.

TUNING BY HAND

The Claw Adjustment controls are located on the Claw board behind the coin mech door. On the Claw board there are 2 thumbwheels adjustment dials, front and back. The front dial is for setting tension, only after back dial has been adjusted correctly.

- 1- Turn crane on
- 2-Turn both adjustment dials all the way counterclockwise
- 3-Put a couple games on the crane
- 4-Run claw out over prizes and let claw drop
- 5-When the claw starts to come back up, start turning the Back dial clockwise until the claw closes. Stop turning dial
- 6-Run claw out over prizes and let claw drop again
- 7-If back adjustment dial is adjustly correctly, claw will close on prizes but not have enough strength to pick up anything
- 8-Adjust front tension dial to desired tension according to prize size clockwise stronger counterclockwise weaker

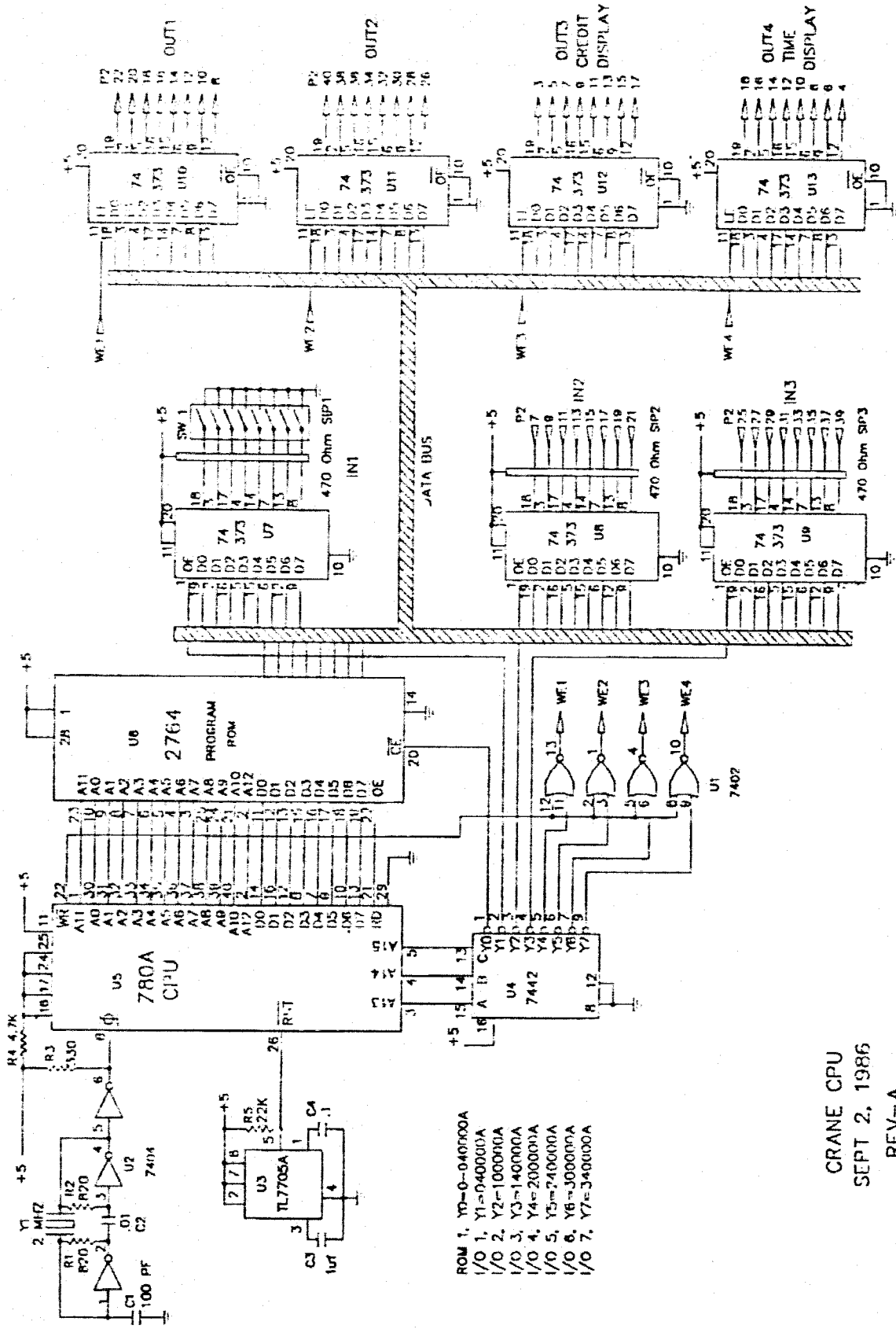

CRANE CPU
 SEPT 2, 1986
 REV--A

LEFT DIGIT DISPLAY

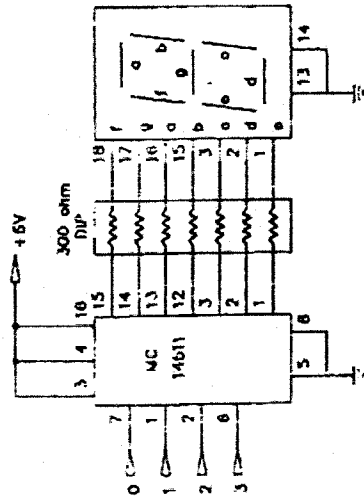

RIGHT DIGIT DISPLAY

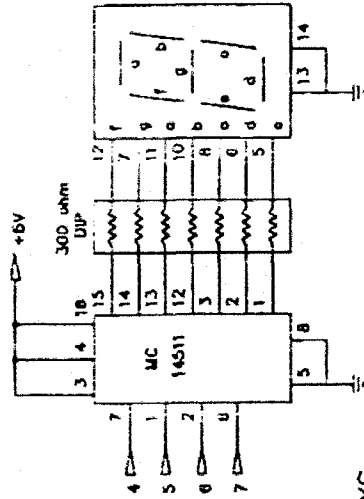

DISPLAYS

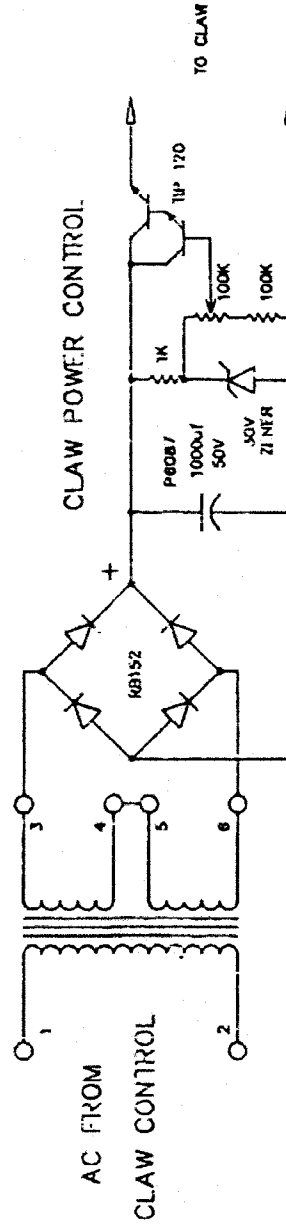

CRANE
 DISPLAY AND CLAW CONTROL
 SEPT 2, 1986

Main Interface harness

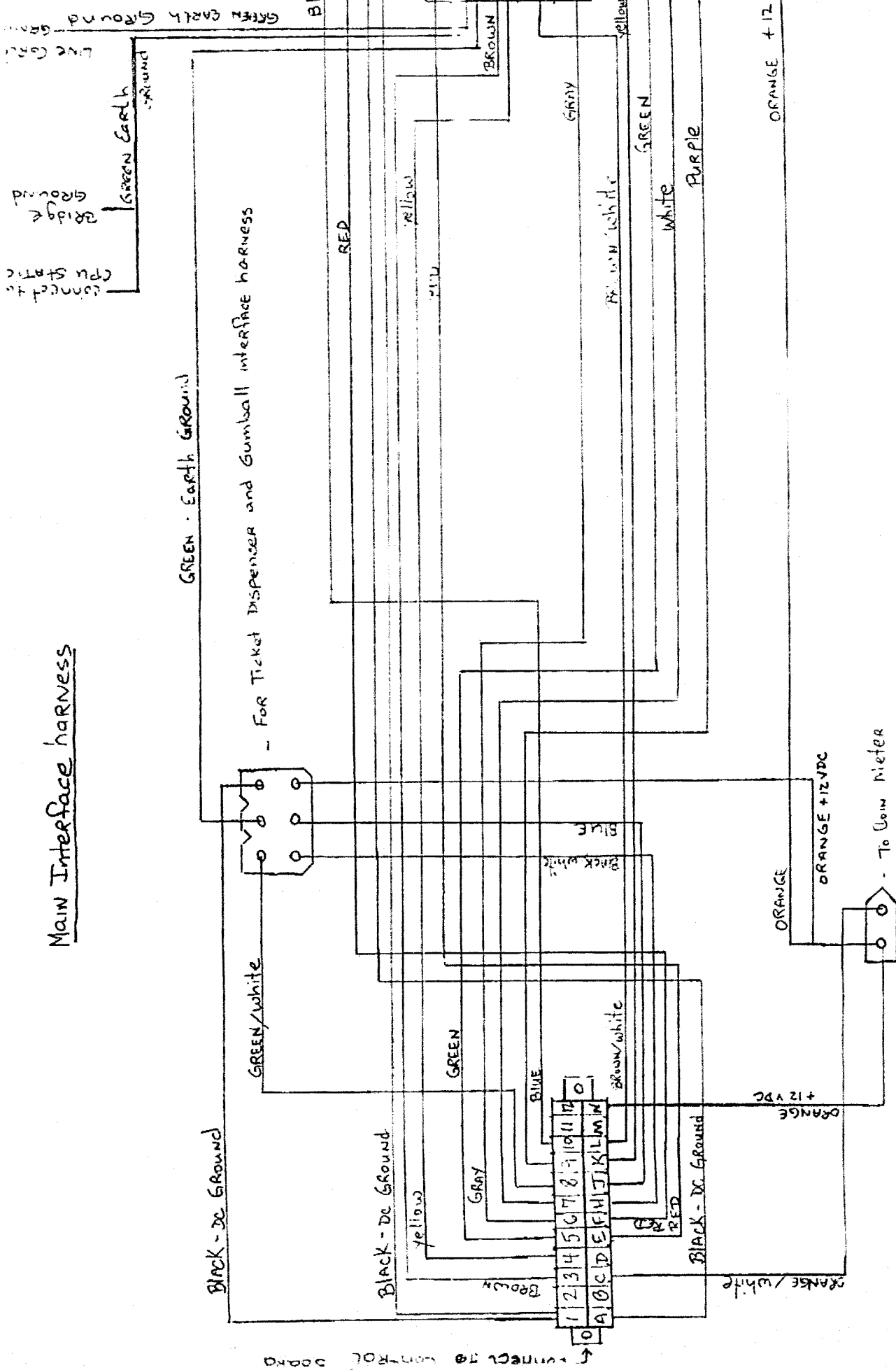

Main Interface harness

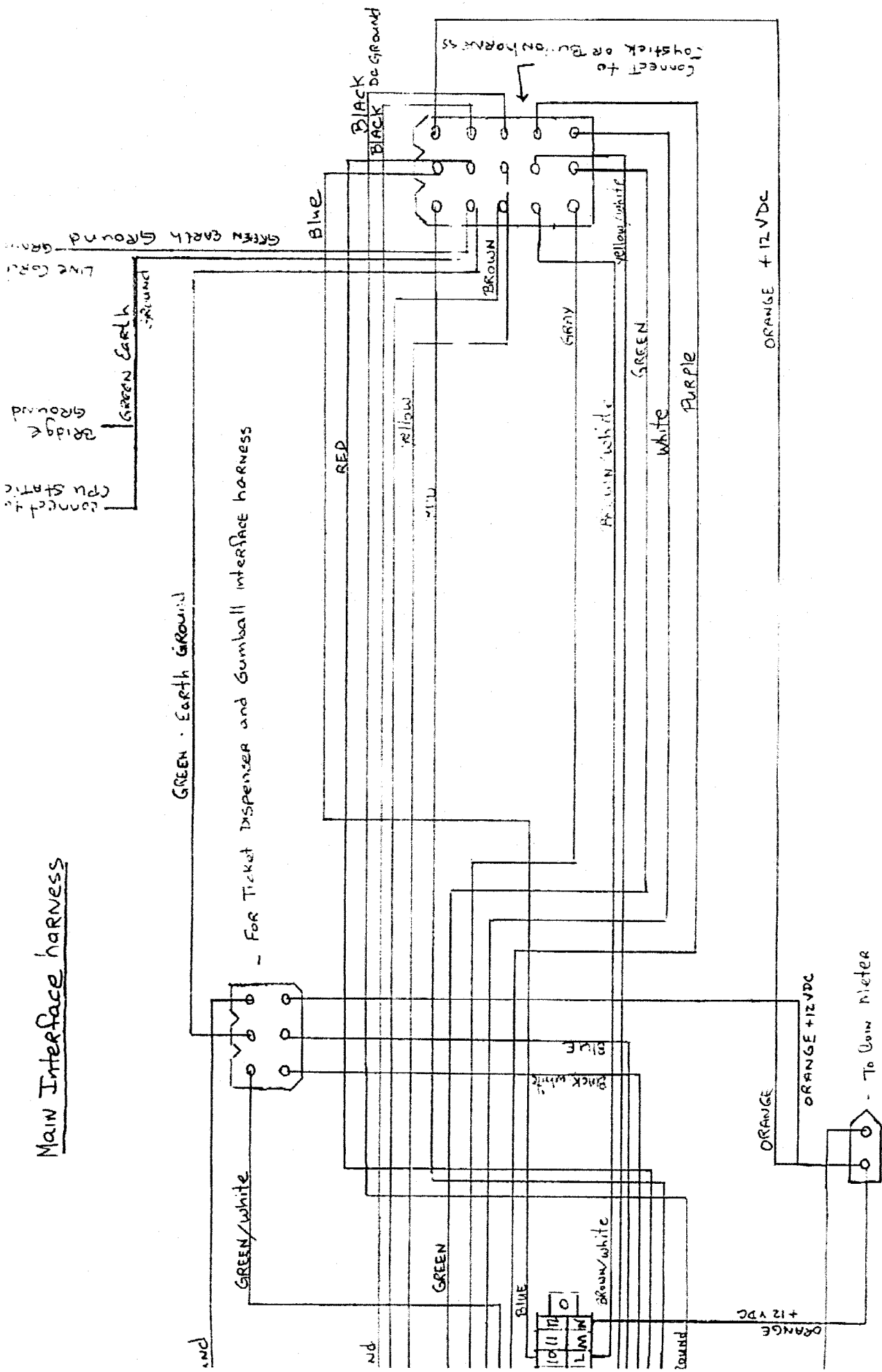

Joy stick harness 9/24/87

Black - DC

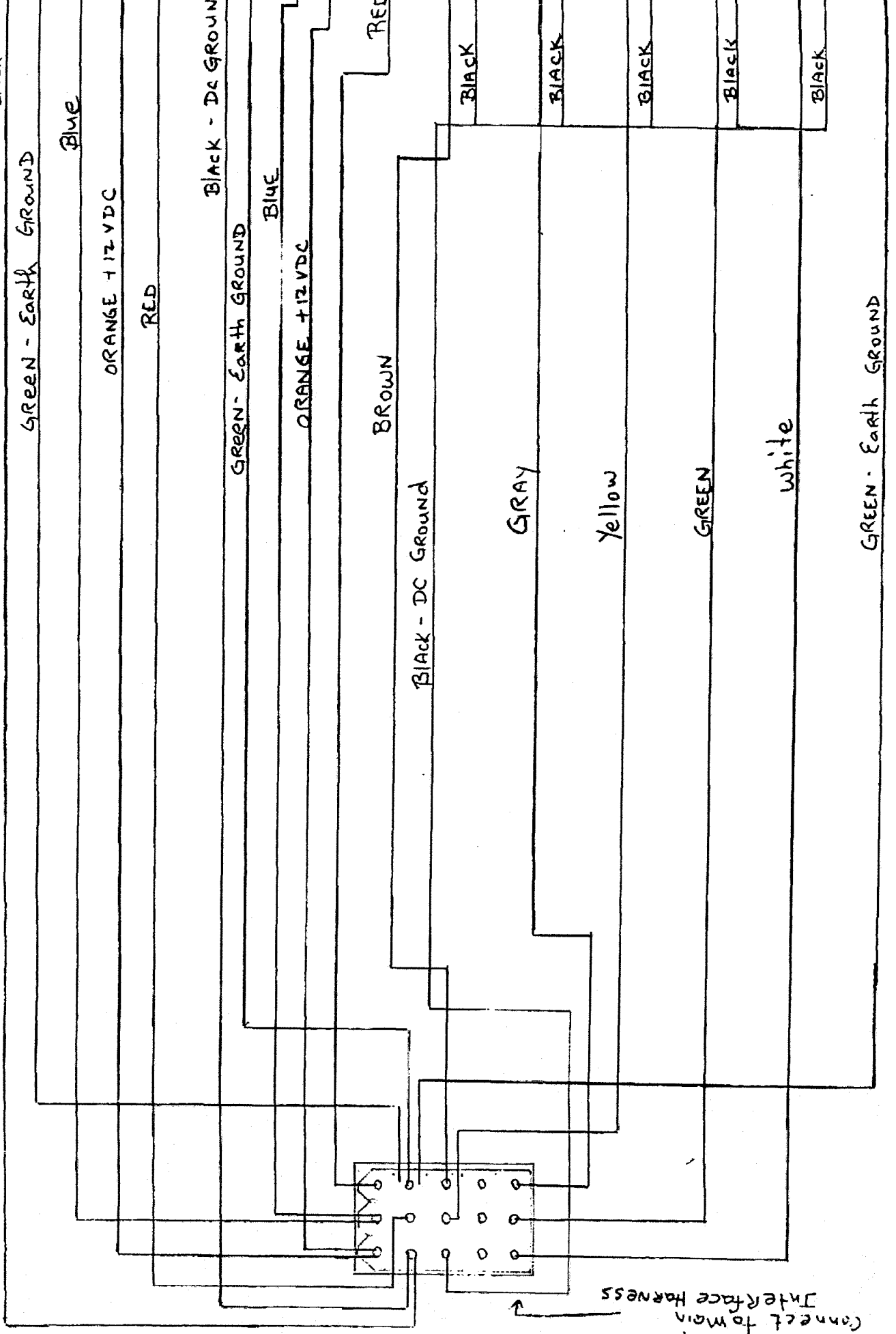

Joy stick harness 9/24/81

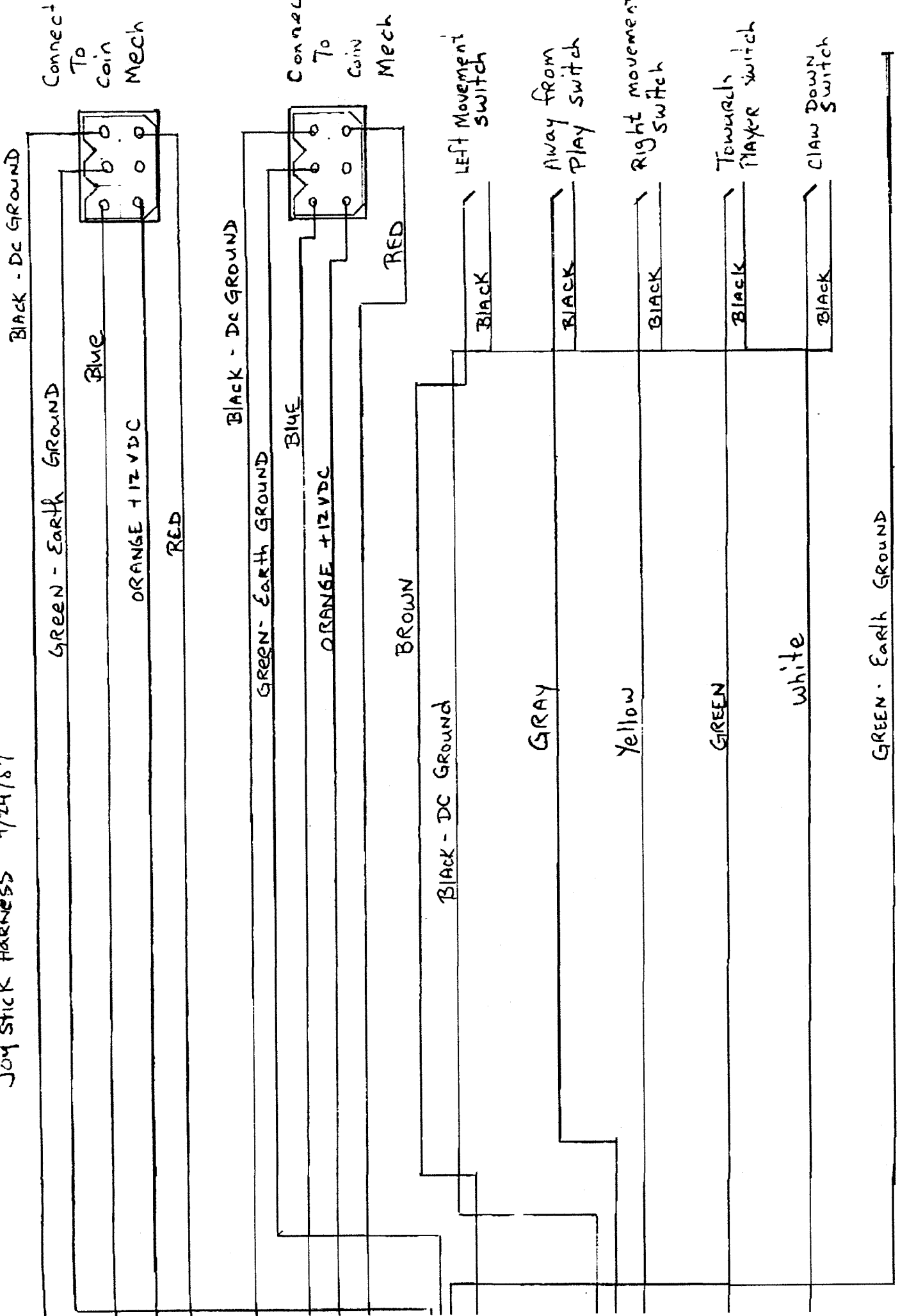

Joystick Wiring

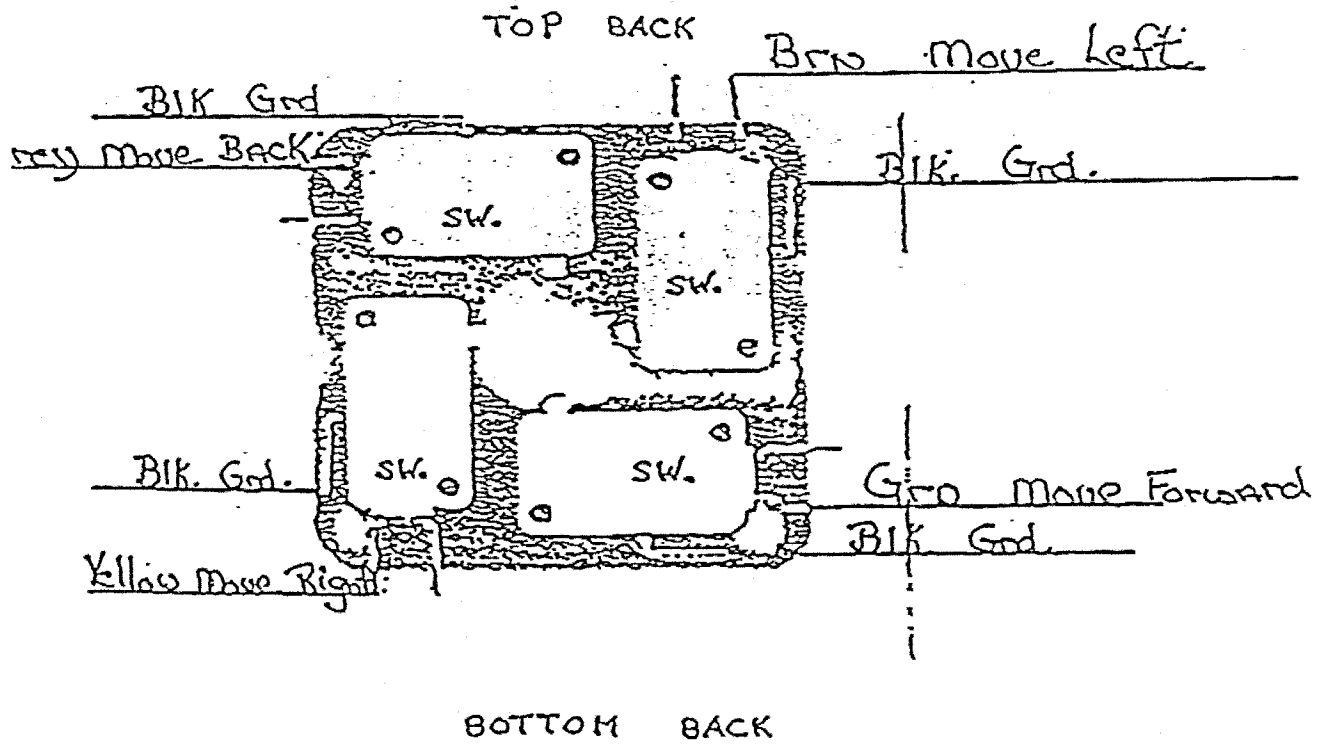
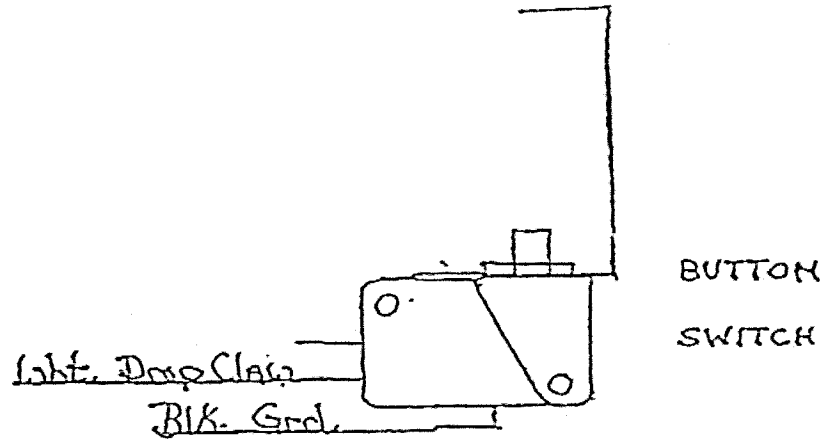

TOP
ALL WHITE STRIPED

L K J H F E D C B A 2 FT GRAY

RED
ORANGE
YELLOW
GREEN
BLUE
PURPLE

P-3-Connector

BOTTOM
ALL SOLID

1 2 3 4 5 6 7 8 9 10

BLACK
GRAY
RED
ORANGE
YELLOW
BROWN
BLUE
PURPLE

2 FT. BROWN

THE CRANE OPERATORS MANUAL

Step 1: Unbox your crane and check for any visible shipping damage, if damage is found, make necessary repairs before placing on location!

Step 2: Install bridge correctly on track and place lights securely in place. Turn power on.

Step 3: Check operation of bill acceptor and coin mechs by running money through them and checking to see that the correct amount of credits is registering. Note; This is operator adjustable!

Step 4: While you have credits on the machine check operation of bridge. Make sure bridge moves all the way back, forward, and side to side. Let claw drop and return to starting position several times. At this time do not worry about claw tension, we will deal with that in the next step! For right now we want to check all moving parts, lights, bill acceptor and coin mech. Make any necessary adjustments.

Step 5: Adjusting the claw tension is the most important factor in running a crane. This will determine the amount of plush your machine will be dispensing, and the amount of profit you as the operator will see.

First, you must acquire an electric meter. You do not need expensive or elaborate equipment, a simple digital readout available at Radio Shack will be the easiest to read and use.

If you already own a regular model that's fine too!

Using a regular needle display meter, set the voltage at 15volts DC current. Open the service door, as you look at the small board to your left, you will notice two adjustable pods, a front pod and one right behind it. These two pods work in conjunction with one another and must be fine tuned as you would the carburetor in a car.

To the right of the pods you will see a plastic connector (one way snap in) with wires sticking straight up. Looking front to back you will notice the first two wires are white.

In the small hole where the first white wire sits, put the RED lead from your electric meter. This might be a little tight, but it must be seated with the first white wire.

Next, in the 2nd hole right behind the first wire place the BLACK lead. Make sure both are securely in place!

Now turn both pods completely off by turning them both counter clockwise till they stop.

With the crane coiled up and ready start playing the crane as you would normally.

Let the claw drop, now on its return up and to the front is the only time you may do any adjusting of the pods!!

Start with the rear pod and turn it to the right until it registers 10 on the 15 volt scale.

This may take a couple of plays to get it as close to being on 10 as possible.

Now with the crane still returning to home position adjust the front pod another 2 increments, so that you have a total read out of 12 on your scale. 10 on the rear pod and 2 more on the front!.

Note; Depending on location and the volume of business you are doing you may fluctuate the front pod setting to please your needs. Moving the front pod 1 more increment will let your'e players win a little more (a total of 13 on your'e scale).

If you follow the above steps, whether you are running 1 or 200 cranes, you will be working on a good payout percentage on all your cranes, about 25 to 33 percent depending which of the above settings you choose.

If you are using a direct digital readout meter don't worry about the 15 volt scale, just set your meter to DC volts and use the direct reading.

Step 6: Now that you have a perfectly tuned machine you are ready to fill it with plush and install it on location. Your first time in a location and the appearance of you're crane is important!. Mainly what we call the FLASH.

If your crane is totally empty, it will need about 2 regular size B&C premixes to fill, this is a nice fill and look.

With your plush in the crane, toss it a couple of times like you would a salad. Now gently face the animals so that they are looking towards you, starting in the front working your way back, slant them in a slight incline with the highest point being the back wall of the crane.

There is no reason to pack or push the animals down since you have already adjusted the claw tension. This gives the crane a good looking appearance and more play appeal. Note; when ever you return to fill or retoss the plush you must repeat this process!. It's a little more work, but your dollar return will be your reward.

Step 7: You are now ready to make some money!.

Always keep in mind the location where your crane is. The only reason now that you would have a problem is if your crane is being tipped over by the location customers. A word with the owner explaining to him that dumping out plush will cause a profit loss for the both of you may help.

The other way to permantly solve the problem is to secure the crane to the wall using sturdy L Brackets. They are easily installed and prevent the crane from being tipped over.

Step 8: These are few things to always do and have on hand.

- 1) Check claw tension every 2-3 weeks.**
- 2) Clean plexi and crane exterior every week.**
- 3) Have a spare Bridge, Power Supply, Claw board, Relay Board, and Control Board to avoid having any down time on your crane.**

You are now armed and ready to handle any problem that may arise in the future.

You have purchased the finest crane available on the market today, and we at Grayhound only wish you the best success in this venture. If there is any way we can help you, please call us at the factory, we will do our best to walk you through any problem that may arise.

**Grayhound Electronics
1-800-222-0491**

VENDING CRANE

DIPSWITCHES

1 2
ON ON _____ 1 CREDIT = \$2.00
OFF ON _____ 1 CREDIT = \$1.00
ON OFF _____ 1 CREDIT = .50 CENTS
OFF OFF _____ 1 CREDIT = .25 CENTS

3
ON _____ SPECIAL CREDIT OPERATION
OFF _____ NORMAL CREDIT OPERATION

4
ON _____ WALTZ AS ATTRACT SONG
OFF _____ STING AS ATTRACT SONG

5
ON _____ 3 MINUTES BETWEEN ATTRACT SONGS
OFF _____ 5 MINUTES BETWEEN ATTRACT SONGS

6
ON _____ ENABLE TICKET DISPENSER
OFF _____ DISABLE TICKET DISPENSER

7
ON _____ DISABLE ATTRACT SONG
OFF _____ ATTRACT SONG ENABLED

8
ON _____ SELFTEST
OFF _____ NORMAL PLAY

***** ERROR CODES *****

88-01 ----- PROBLEM WITH UP SWITCH, UP PLATE STUCK,
OR BOARD PROBLEM

99-11 ----- TICKET DISPENSER JAMMED OR EMPTY

GRAYHOUND CRANE DIP SWITCH SETTINGS

DIP SWITCH SETTINGS

1 2 3 4 5 6 7 8

DIP SWITCH #1 & #2

ON	ON	-----2.00 PER PLAY-----
OFF	ON	-----1.00 PER PLAY-----
ON	OFF	----- .50 PER PLAY-----
OFF	OFF	----- .25 PER PLAY-----

DIP SWITCH #3 & #4

ON	ON	-----60 SEC PER PLAY
OFF	ON	-----45 SEC PER PLAY
ON	OFF	-----30 SEC PER PLAY
OFF	OFF	-----15 SEC PER PLAY

DIP SWITCH #5

OFF-BUTTONS CONTROL
ON - JOYSTICK CONTROL

DIP SWITCH # 6 ON (FOR TICKET DISP.)

DIP SWITCH # 7 NOT USED OFF DISABLE

DIP SWITCH #8

OFF - NORMAL PLAY
ON - SELF TEST

UNITED TEXTILE FABRICATORS
UNITED TEXTILE FABRICATORS
ROUTE 37
P.O. BOX 4988
TOMS RIVER N.J. 08754-4988
1-800-833-4667 FAX: 732-341-3351 732-286-1120

UNITED TEXTILE PROVIDES TECHNICAL SUPPORT AND REPAIRS
FOR ALL TREASURE CHEST, TALON, SOUTH BEACH, GRAYHOUND,
RAINBOW, UNITED TEXTILE, AND OTHER CRANES

Bought out Grayhound Cranes

<http://www.unitedtextile.net/>