

±12V 2-12C

±5V 2-12C

±5V 2-12E

OPAMP	YTA301K	0.1μF (4.7)
		0.1μF (4.7)
		0.1μF (4.7)

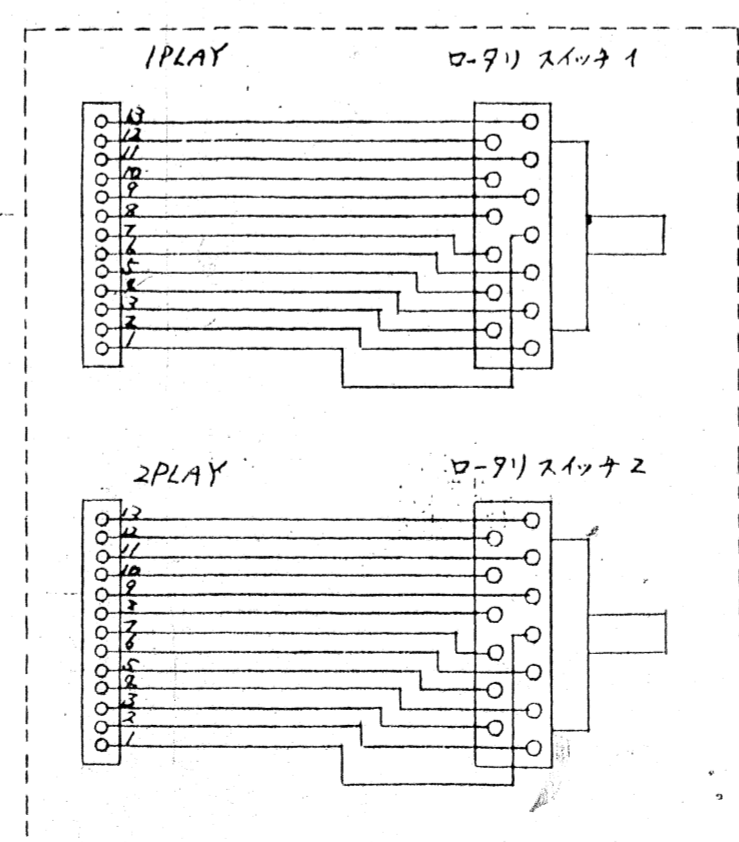
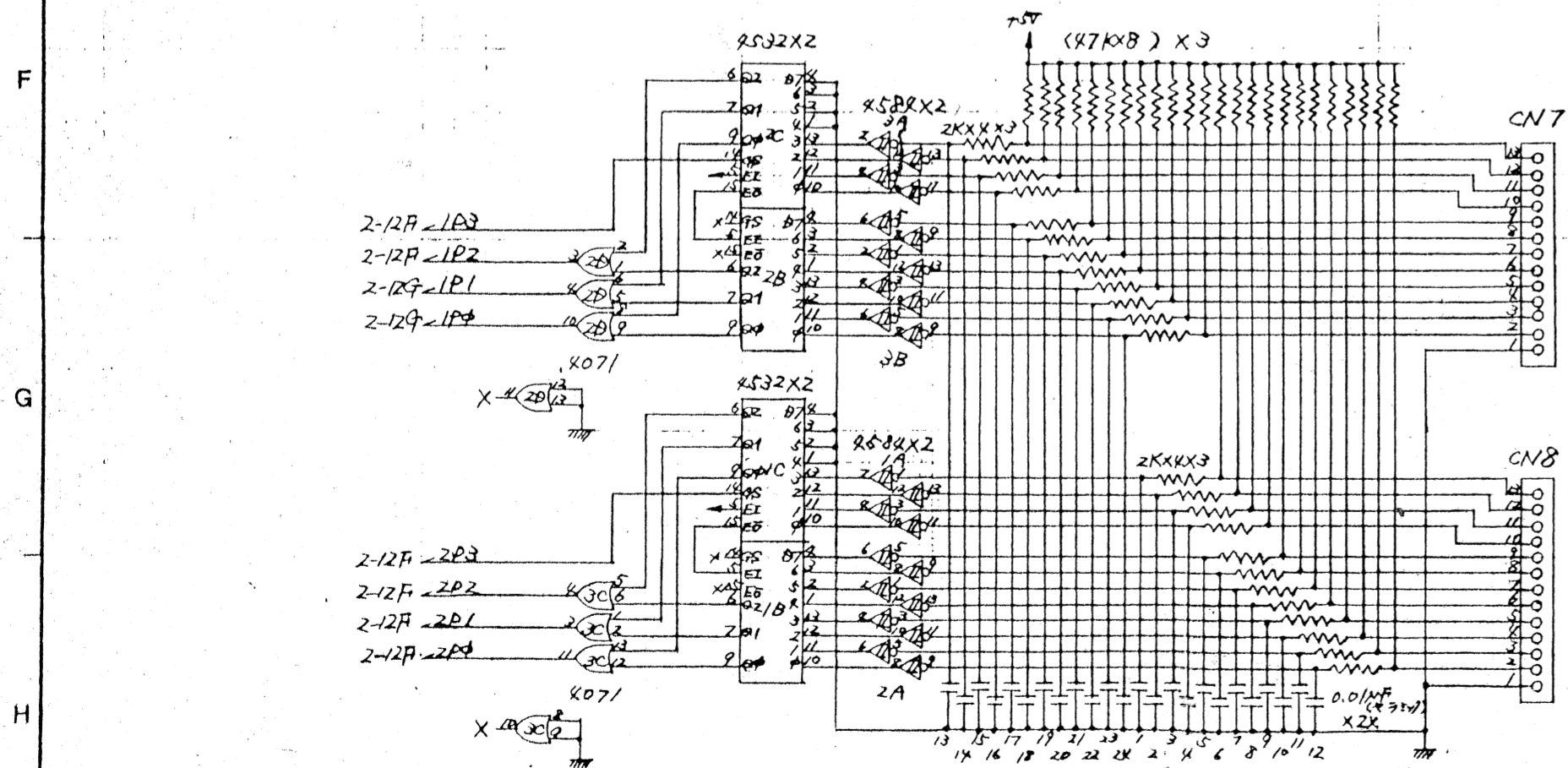

内の回路はA5004UP03に接続する外付け回路

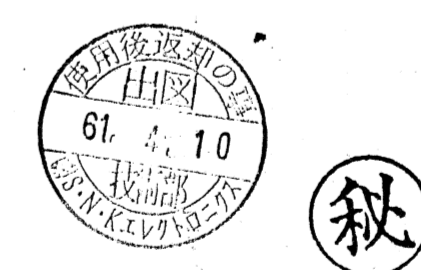

MARK	REVISION	ORG.	SNK CORPORATION NAME: MUSIC ROTARY TYPE: DRG.No. A5004 UC 03 3/3
Δ			

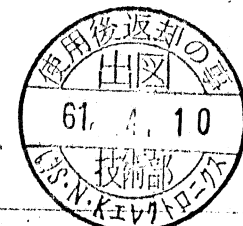

秘

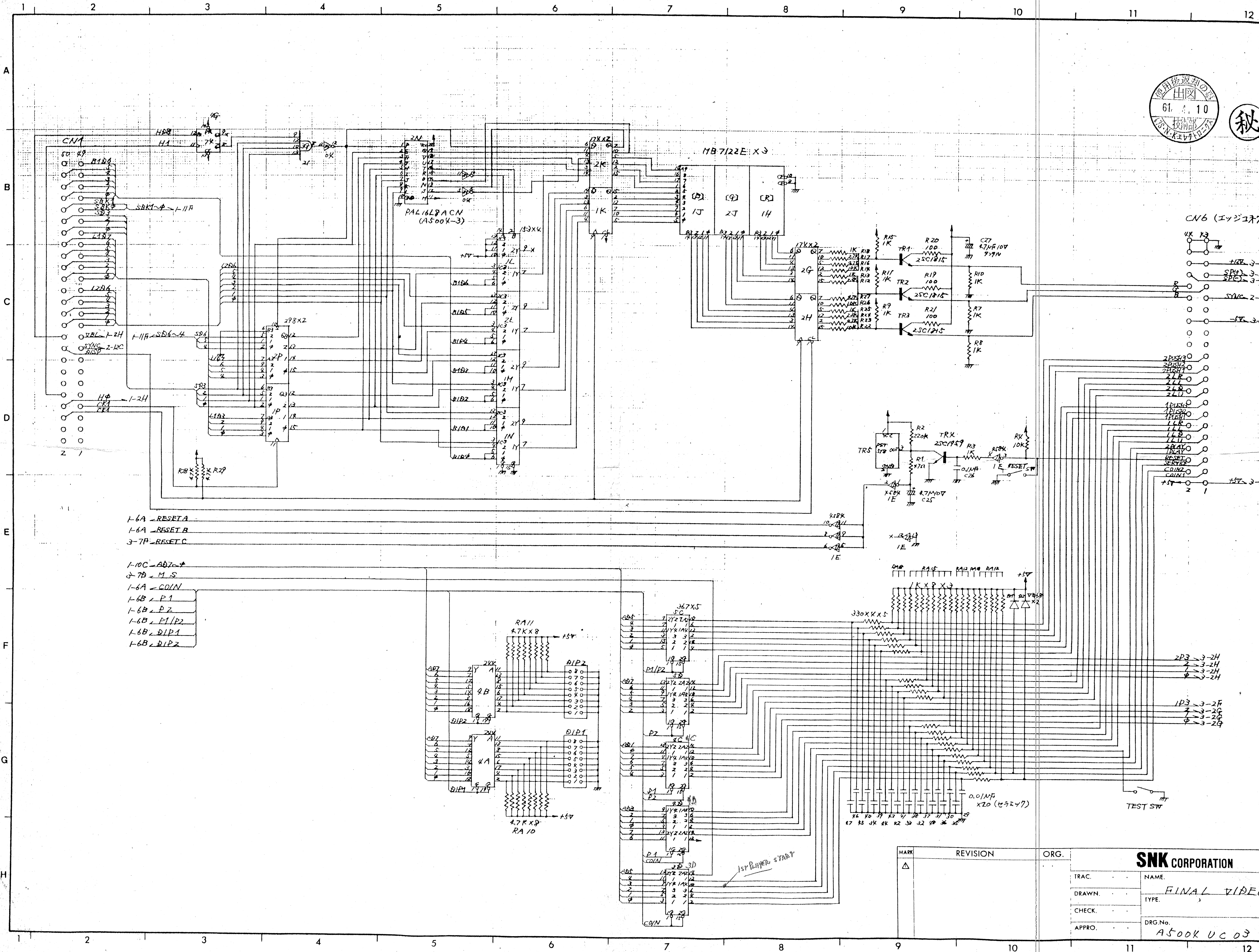

1-6A - RESET A
1-6A - RESET B
3-7P - RESET C

1-10C - ADI
2-7D - M.S
1-6A - COUN
1-6B - P1
1-6B - P2
1-6B - P1/P2
1-6B - DIP1
1-6B - DIP2

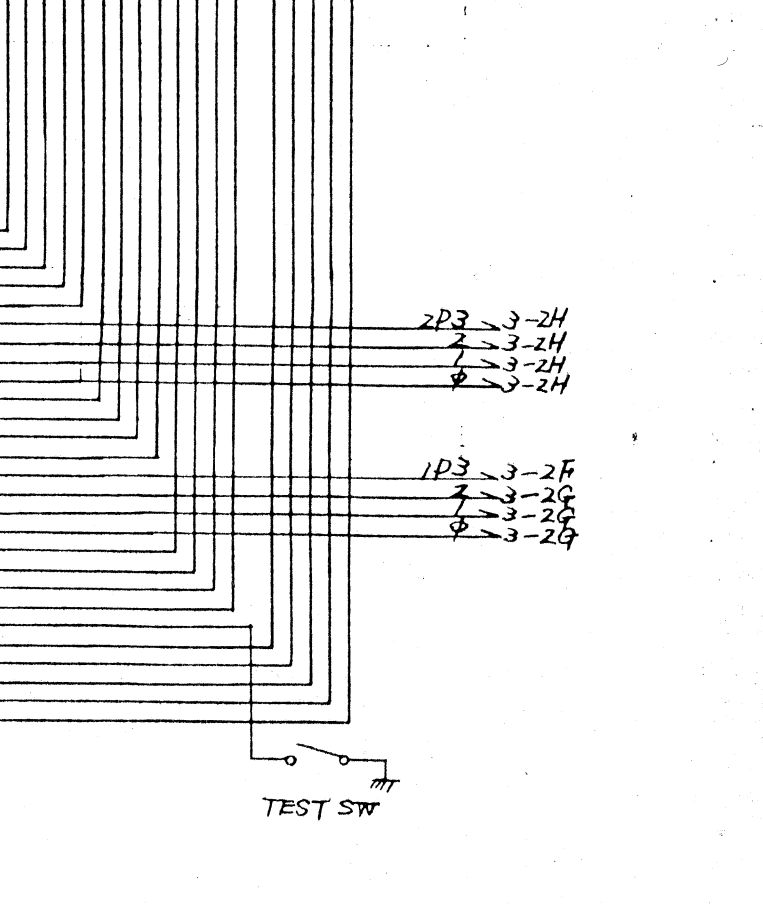
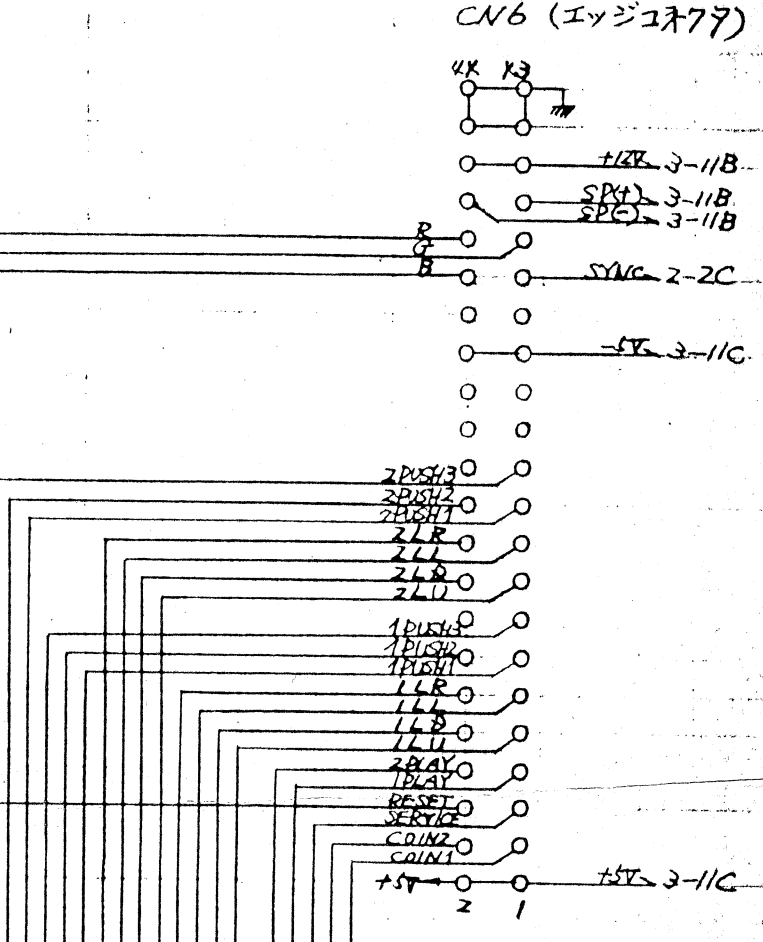
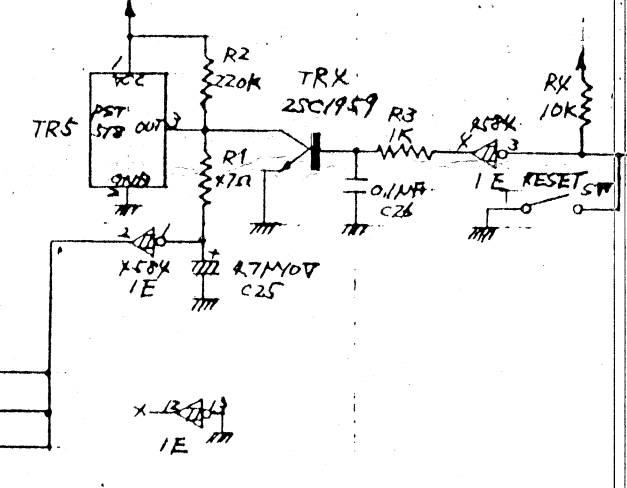
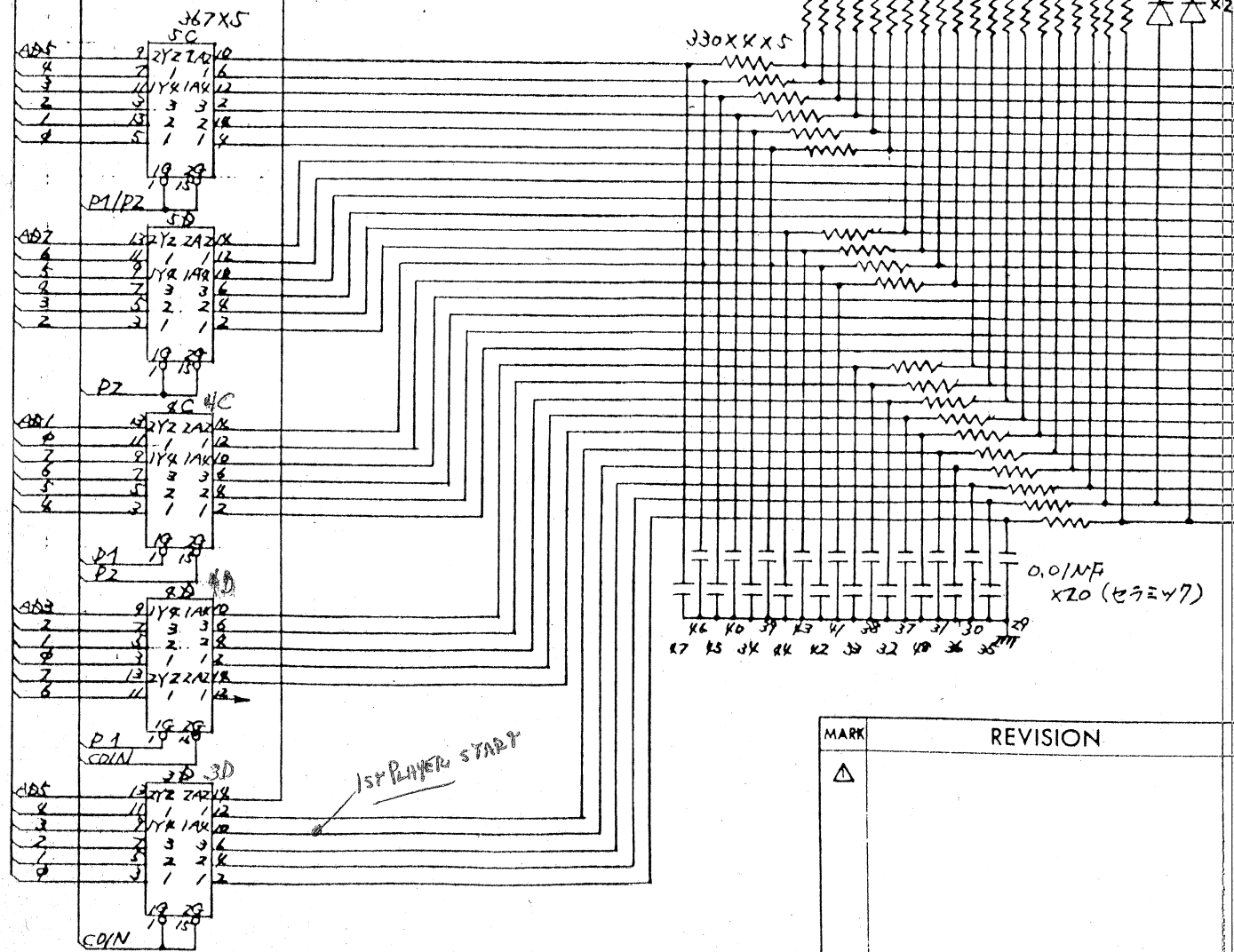
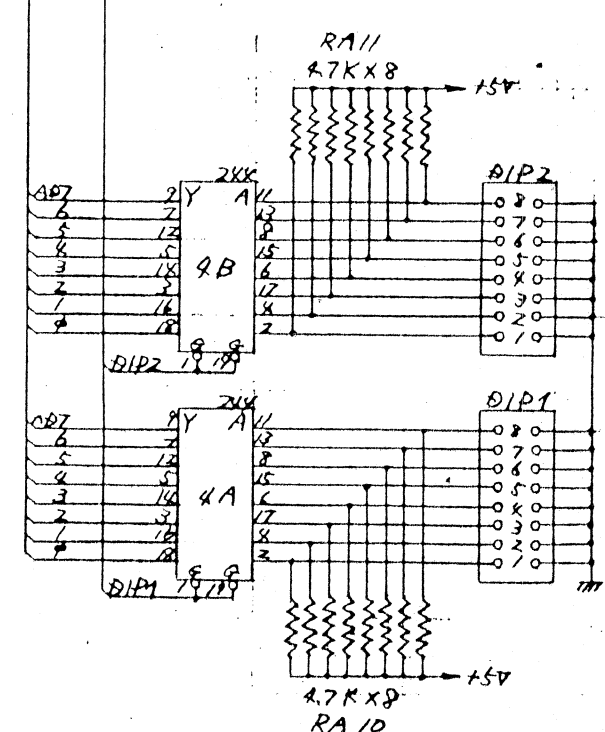

MARK	REVISION	ORG.	NAME
△			FINAL VIDEO
			TYPE
			DRG.No.
			A500K UC 03

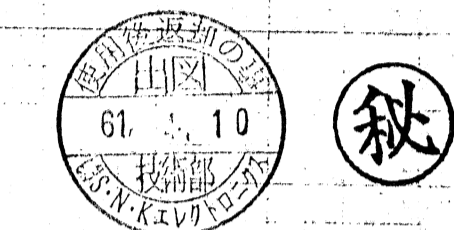
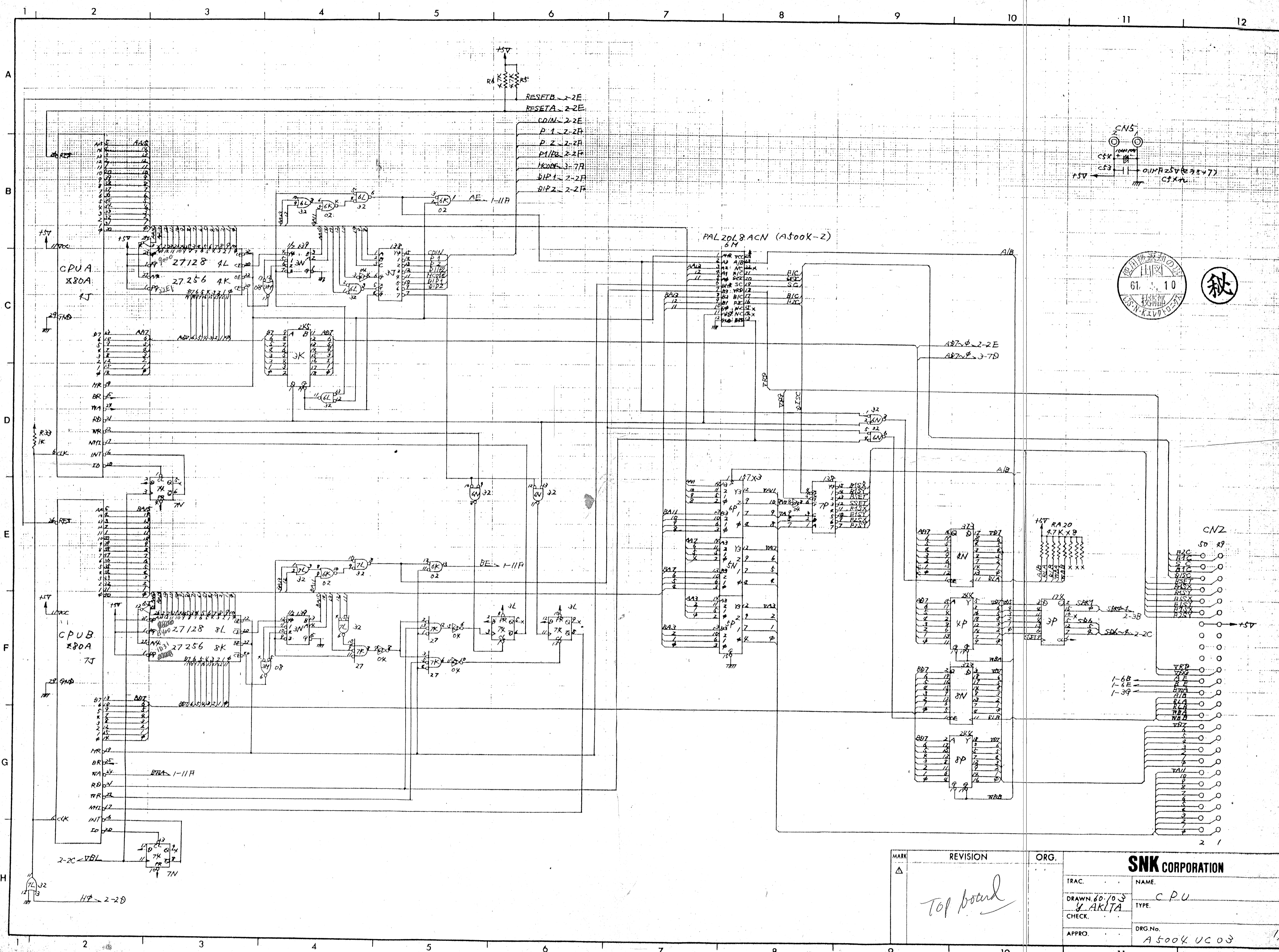

MARK	REVISION	ORG.	SNK CORPORATION	
Δ	Top board		TRAC.	NAME
			DRAWN 60.10.5 Y. AKITA	CPU
			CHECK.	TYPE.
			APPRO.	DRG.No.
				A500K UC03

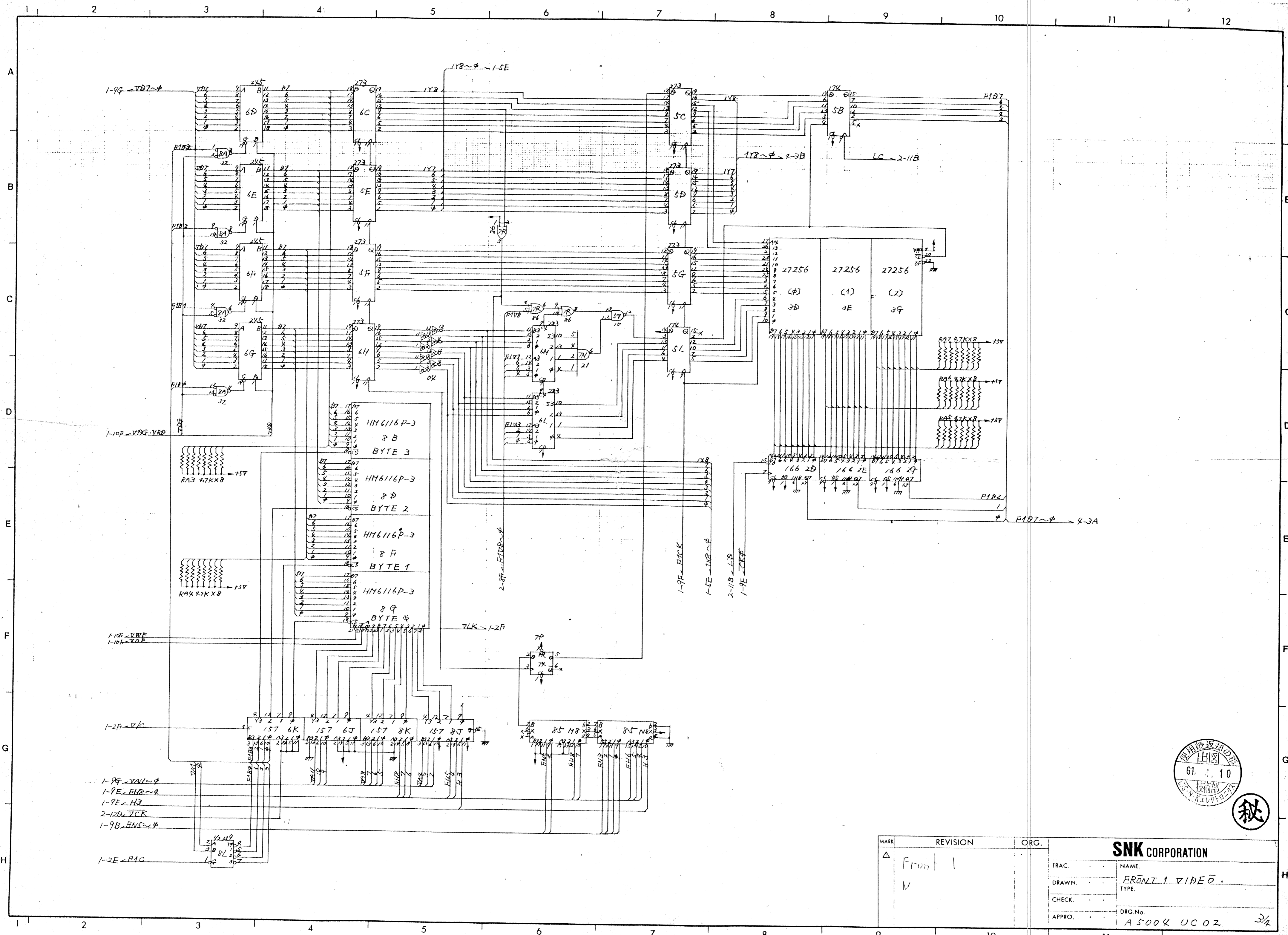

1-9G-VB7-φ
 1-9E-EH8-φ
 1-9E-H3
 2-12B-VCK
 1-9B-ENC-φ
 1-2E-E1G



MARK	REVISION	ORG.	SNK CORPORATION	
Δ	Front 1		TRAC.	NAME
			DRAWN.	FRONT 1 VIDEO
			CHECK.	TYPE
			APPRO.	DRG. No.
				A5004 UCOZ

秘

3/4

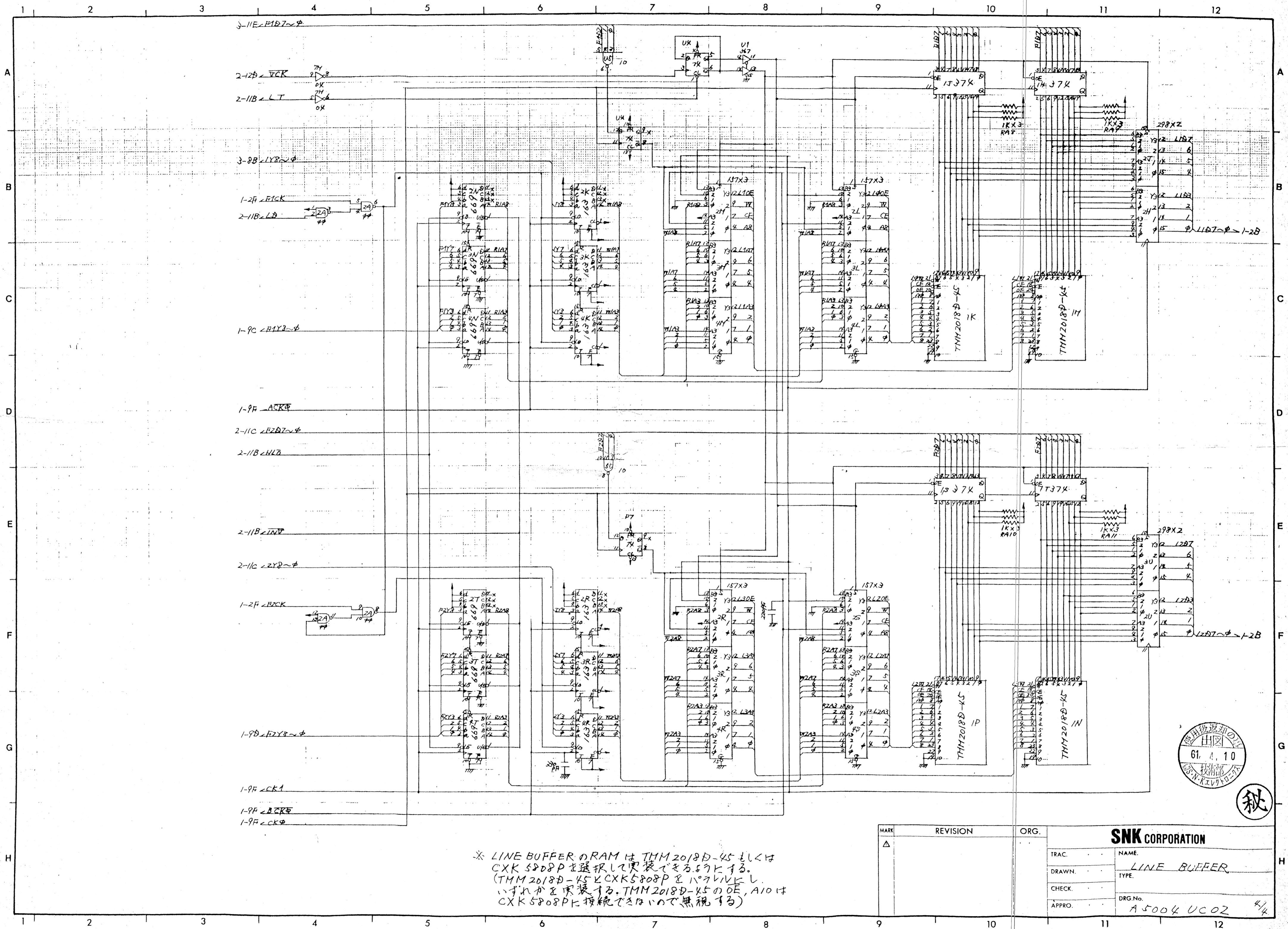

※ LINE BUFFERのRAMはTMM2018D-45もしくは
 CXK5808Pを接続して実装できるようにする。
 (TMM2018D-45とCXK5808Pを1:1で入れ
 いかを交換する。TMM2018D-45のOE, A10は
 CXK5808Pに接続するはいいで無視する)

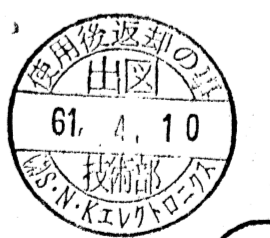

秘

MARK	REVISION	ORG.	TRAC.	NAME
△				LINE BUFFER
			DRAWN.	TYPE.
			CHECK.	DRG.No.
			APPRO.	A5004 UC02 4/4

SNK CORPORATION

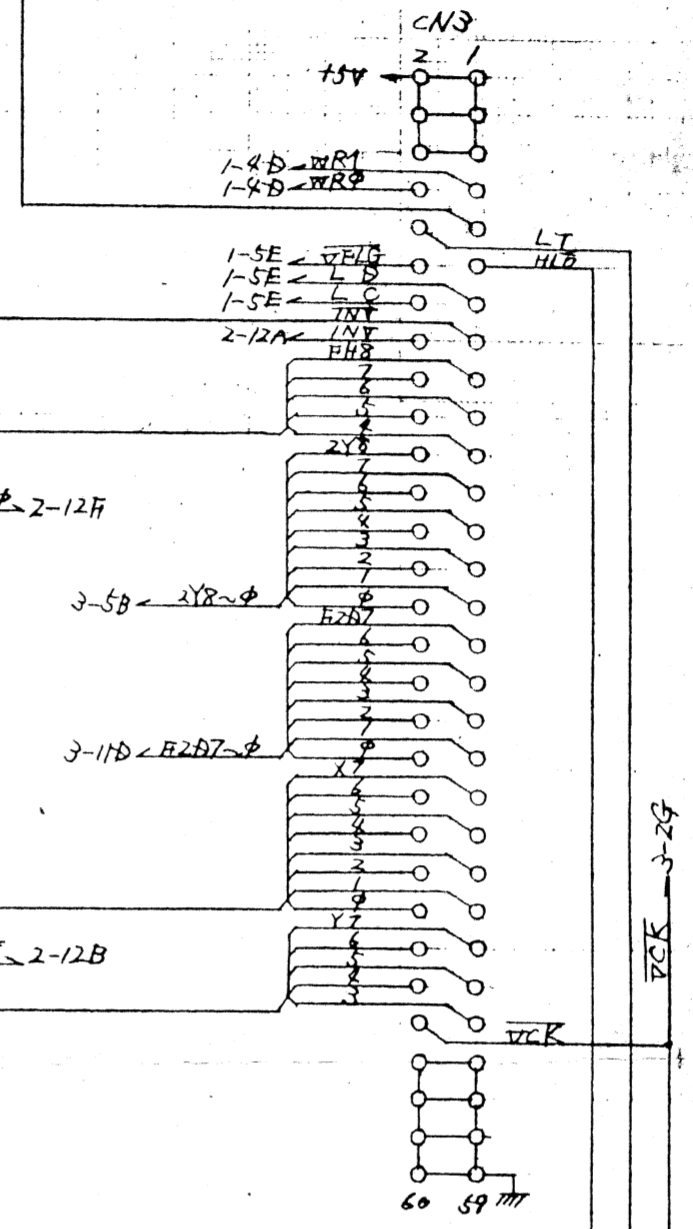
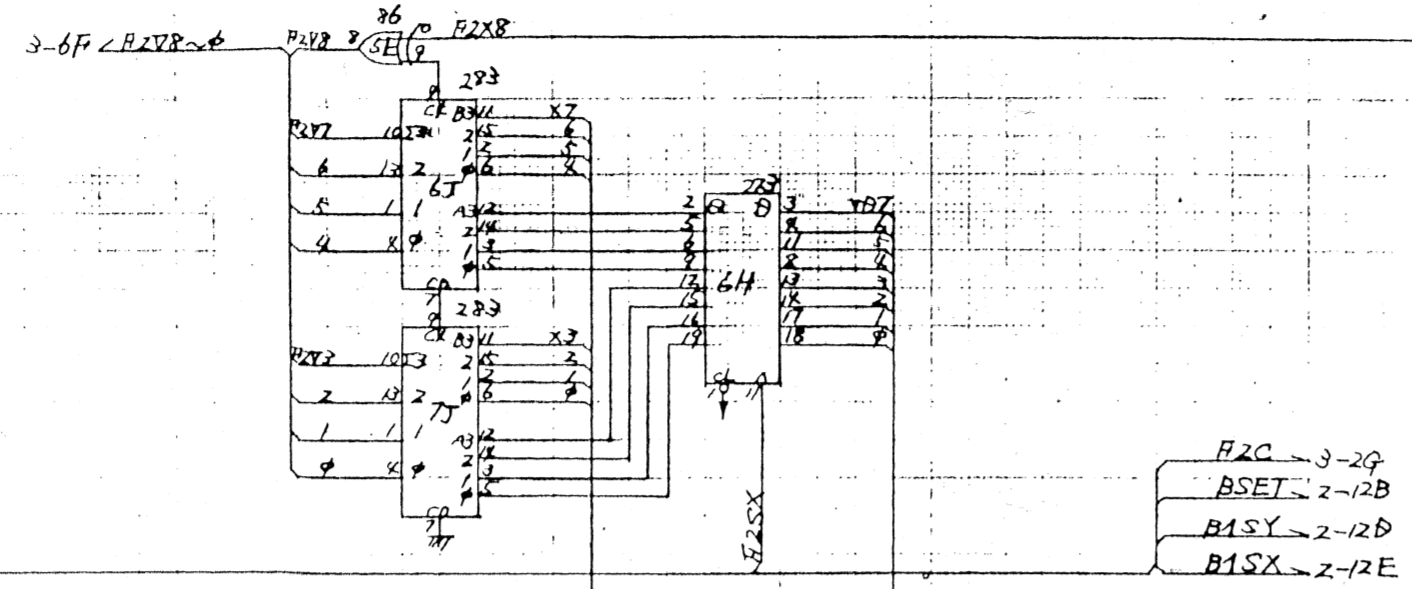
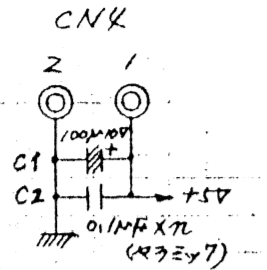
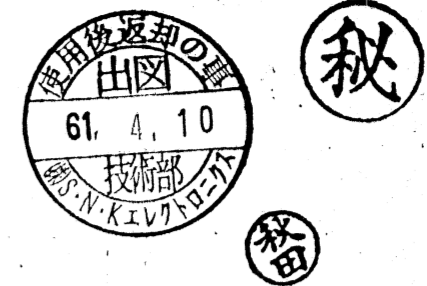

B2C 3-2G
B2E 2-12B
B2Y 2-12B
B2X 2-12E

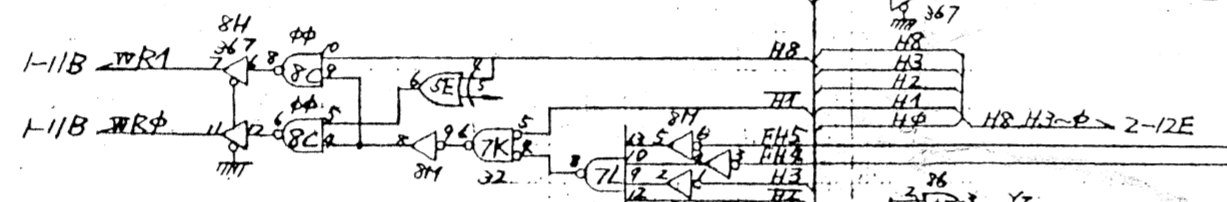

VK 2-8F, 3-6F
V/C 2-8F, 3-2F
VWE 2-8F, 3-2E
VDE 2-8F, 3-2F
VFD 2-8F, 3-2B
VDF 2-8F, 3-2B

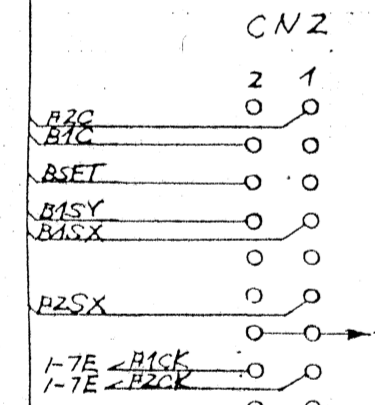

B2C
B2E
B2Y
B2X
1-7E BACK
1-7E B2C

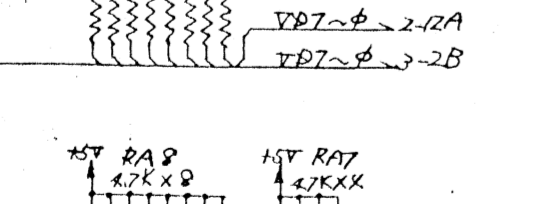
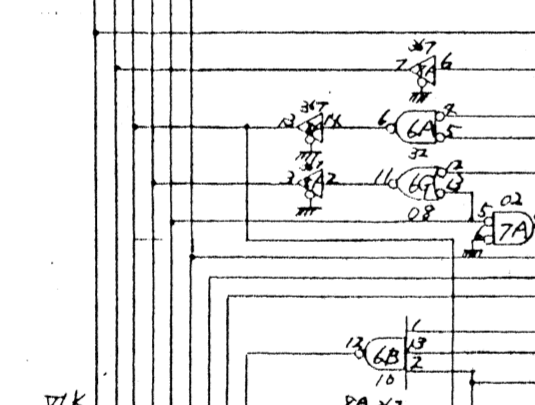

VAV 2-12A
VAV 3-2G
B10 2-9F
B11 2-9F
B12 2-9F
B13 2-9F
B14 2-9F
B15 2-9F
B16 2-9F
B17 2-9F
B18 2-9F
B19 2-9F
B20 2-9F
B21 2-9F
B22 2-9F
B23 2-9F
B24 2-9F
B25 2-9F
B26 2-9F
B27 2-9F
B28 2-9F
B29 2-9F
B30 2-9F
B31 2-9F
B32 2-9F
B33 2-9F
B34 2-9F
B35 2-9F
B36 2-9F
B37 2-9F
B38 2-9F
B39 2-9F
B40 2-9F
B41 2-9F
B42 2-9F
B43 2-9F
B44 2-9F
B45 2-9F
B46 2-9F
B47 2-9F
B48 2-9F
B49 2-9F
B50 2-9F
B51 2-9F
B52 2-9F
B53 2-9F
B54 2-9F
B55 2-9F
B56 2-9F
B57 2-9F
B58 2-9F
B59 2-9F
B60 2-9F
B61 2-9F
B62 2-9F
B63 2-9F
B64 2-9F
B65 2-9F
B66 2-9F
B67 2-9F
B68 2-9F
B69 2-9F
B70 2-9F
B71 2-9F
B72 2-9F
B73 2-9F
B74 2-9F
B75 2-9F
B76 2-9F
B77 2-9F
B78 2-9F
B79 2-9F
B80 2-9F
B81 2-9F
B82 2-9F
B83 2-9F
B84 2-9F
B85 2-9F
B86 2-9F
B87 2-9F
B88 2-9F
B89 2-9F
B90 2-9F
B91 2-9F
B92 2-9F
B93 2-9F
B94 2-9F
B95 2-9F
B96 2-9F
B97 2-9F
B98 2-9F
B99 2-9F
B100 2-9F

MARK	REVISION	ORG.	NAME
			CLOCK
			TYPE
			DRG. No.
			A5004 UC01 1/3

Bottom board

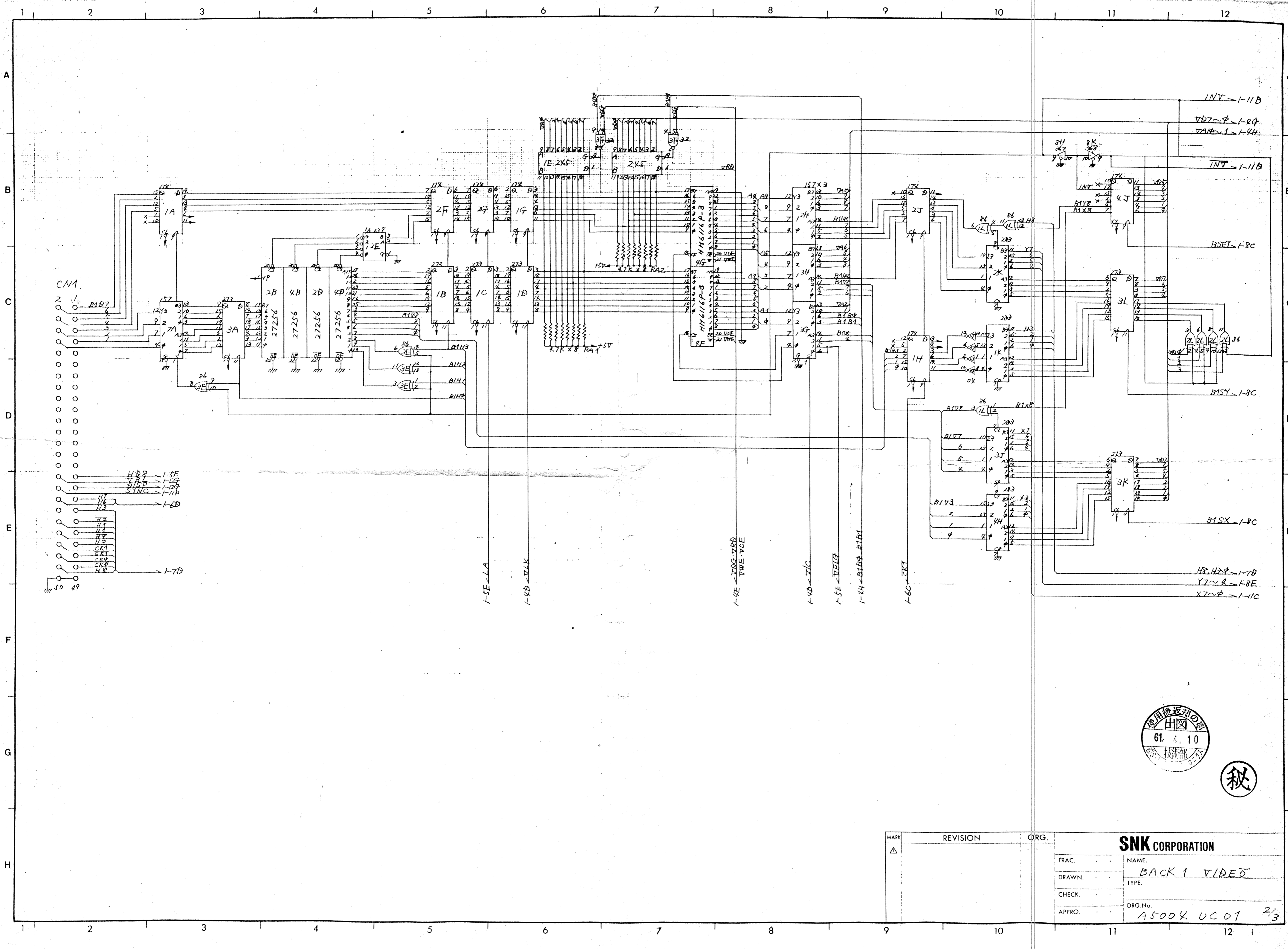

使用済みの部品
61. 1. 10
技術部

秘

MARK	REVISION	ORG.	NAME
Δ			BACK 1 VIDEO
			TYPE
			DRG.No. A500X UC 01 2/3
			APPRO.
			TRAC.
			DRAWN.
			CHECK.
			APPRO.

SNK CORPORATION

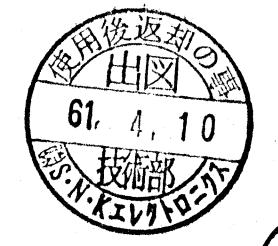
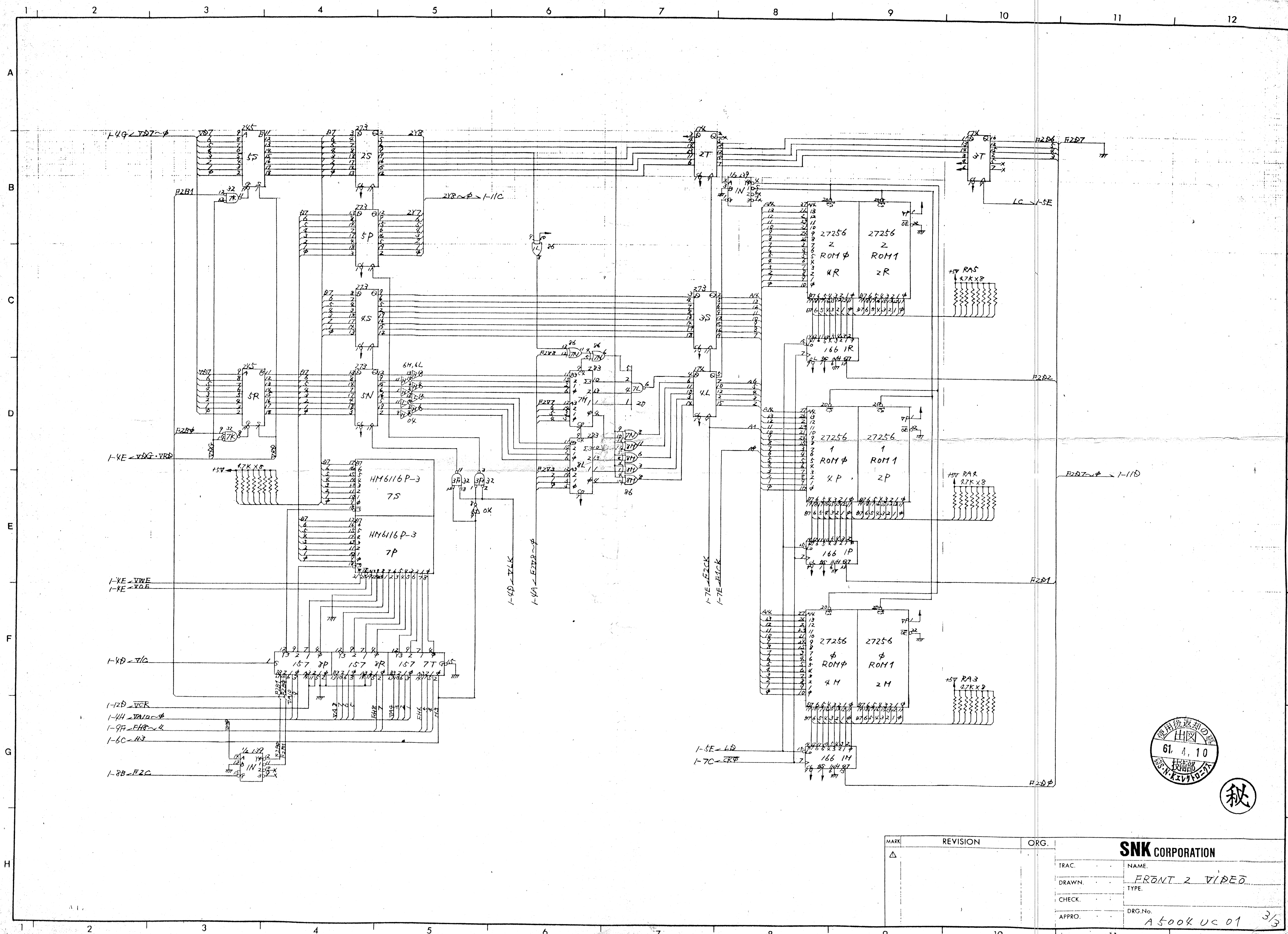

MARK	REVISION	ORG.	SNK CORPORATION	
Δ			TRAC.	NAME
			DRAWN.	FRONT 2 VIDEO
			CHECK.	TYPE
			APPRO.	DRG.No.
				A500K UC 01 3/3

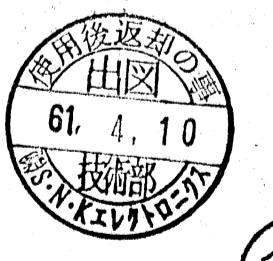
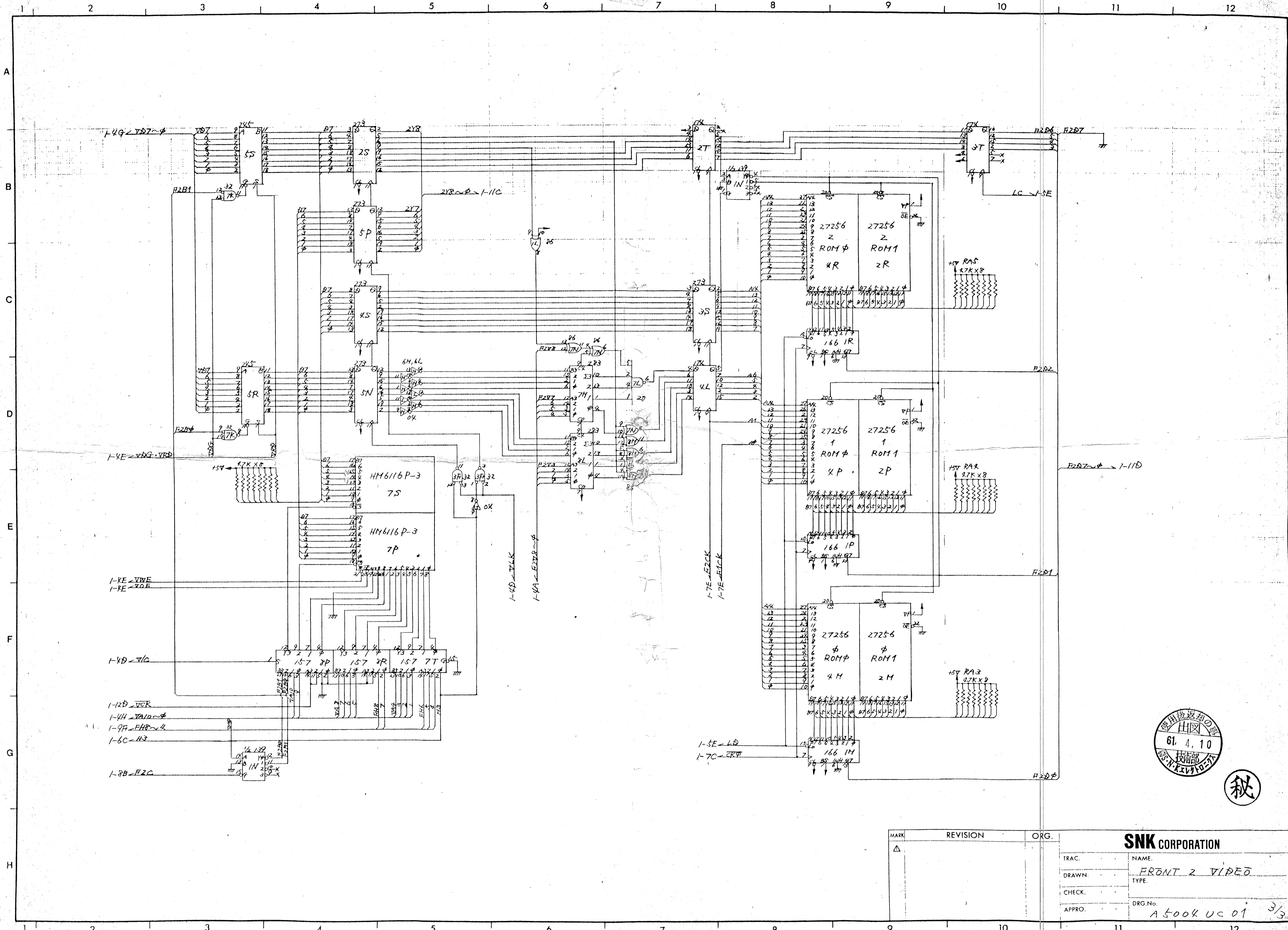

秘

MARK	REVISION	ORG.	SNK CORPORATION	
△			TRAC.	NAME.
			DRAWN.	FRONT 2 VIDEO
			CHECK.	TYPE.
			APPRO.	DRG.No.
				A5004 UC 01 3/3