



Software
Conversion Kit
Kit Installation Instructions & Service Manual

1 - 2 PLAYER GAME

SEGA AMUSEMENTS USA, INC.

MANUAL NO. 999-1787
GAME CODE: TOTK

VISIT OUR WEBSITE!

The screenshot shows a browser window with the address bar containing <http://www.seuservice.com/>. The browser's navigation bar includes buttons for Back, Forward, Stop, Refresh, Home, AutoFill, Print, and Mail. The website content features the SegaService logo in large, stylized blue letters. To the left of the logo, the text "Help is on the way!!" is displayed in blue, accompanied by two cartoon characters: a bee wearing a hat and a police officer. Below the logo, a list of site features is shown: • Bulletins, • Darl's Office, • Game Manuals, • Search, and • What's New. A central message reads: "If you have any questions or comments about this site please E-Mail to Darl.Davidson@seu.sega.com". Below this is a "POWERED BY Mac OS X" logo. A list of site links is provided: [\[what's new\]](#), [\[manuals\]](#), [\[bulletins\]](#), [\[assemblies\]](#), [\[specials\]](#), [\[Search\]](#), [\[staff\]](#), [\[Darl's office\]](#), [\[Return/Parts Policy\]](#), [\[warranty\]](#), [\[corporate info\]](#), [\[plugins\]](#), and [\[Non-framed page\]](#). A note states: "You will need the following items to view this page in its entirety." Below this are logos for Adobe Acrobat Reader and Microsoft Internet Explorer. At the bottom, it says "All Platforms Windows Macintosh". The browser's status bar at the bottom left shows "Internet zone".

BEFORE USING THE PRODUCT, BE SURE TO READ THE FOLLOWING:

To maintain the safety:

To ensure the safe usage of the product, be sure to read the following before using the product. The following instructions are intended for the users, operators and the personnel in charge of the operation of the product. After carefully reading and sufficiently understanding the warning displays and cautions, handle the product appropriately. Be sure to keep this manual nearby the product or elsewhere convenient for referring to it when necessary.

Herein, explanations which require special attention are enclosed with dual lines. Depending on the potentially hazardous degrees, the terms of WARNING, CAUTION, etc. are used. Be sure to understand the contents of the displays before reading the text.



Indicates that mishandling the product by disregarding this warning will cause a potentially hazardous situation which can result in death or serious injury.



Indicates that mishandling the product by disregarding this caution will cause a slight hazardous situation which can result in personal injury and or material damage.

For the safe usage of the product, the following pictographs are used:



Indicates “HANDLE WITH CARE.” In order to protect the human body an equipment, this display is attached to places where the Owner’s Manual and or Service Manual should be referred to.

- **Perform work in accordance with the instructions herein stated.**
Instructions for work are explained by paying attention to the aspect of accident prevention. Failing to perform work as per the instructions can cause accidents. In the case where only those who have technical expertise should perform the work to avoid hazardous situation, the instructions herein state that the serviceman should perform such work.
- **Be sure to turn off power before working on the machine.**
To prevent electric shock, be sure to turn off power before starting the work in which the worker touches the interior of the product. If the work is to be performed in the power-on status, the Instruction Manual herein always states to that effect.
- **Be sure to ground the Earth Terminal** (this, however, is not required in the case where a power cord with earth is used).
This product is equipped with the Earth Terminal. When installing the product, Connect the Earth Terminal to the “accurately grounded indoor earth terminal” by using an earth wire. Unless the product is grounded appropriately, the user can be subject to electric shock. After performing repair, etc. for the Control equipment, ensure that the Earth Wire is firmly connected to the Control equipment.
- **Ensure that the Power Supply used is equipped with an Earth Leakage Breaker.**
This product does not incorporate the Earth Leakage Breaker. Using a power supply which is not equipped with the Earth Leakage Breaker can cause a fire when earth leakage occurs.
- **Be sure to use fuses which meet the specified rating.** (only for the machines which use fuses).
Using fuses exceeding the specified rating can cause a fire and electric shock.

- **Specification changes (removal of equipment, conversion and addition) not designated by SEGA are not allowed.**
The parts of the product include warning labels for safety, covers for personal protection, etc. It is very hazardous to operate the product by removing parts and or modifying the circuits. Should doors, lids and protective parts be damaged or lost, refrain from operating the product, and contact where the product was purchased from or the office herein stated. SEGA shall not be held responsible for any accidents, compensation for damage to a third party, resulting from the specifications not designated by SEGA.
 - **Ensure that the product meets the requirements of appropriate Electrical Specifications.**
Before installing the product, check for Electrical Specifications. SEGA products have a nameplate on which Electrical Specifications are described. Ensure that the product is compatible with the power supply voltage and frequency requirements of the location. Using any Electrical Specifications different from the designated Specifications can cause a fire and electric shock.
 - **Install and operate the product in places where appropriate lighting is available, allowing warning labels to be clearly read.**
To ensure safety for the customers, labels and printed instructions describing potentially hazardous situation are applied to places where accidents can be caused. Ensure that where the product is operated has sufficient lighting allowing the warnings to be read. If any label is peeled off, apply it again immediately. Please place an order with where the product was purchased from or the office herein stated.
 - **When handling the Monitor, be very careful. (Applies only to the product w/monitor.)**
Some of the monitor (TV) parts are subject to high tension voltage. Even after running off power, some portions are still subject to high tension voltage sometimes. Monitor repair and replacement should be performed only by those technical personnel who have knowledge of electricity and technical expertise.
 - **Be sure to adjust the monitor (projector) properly. (Applies only to the product w/monitor.)**
Do not operate the product leaving on-screen flickering or blurring as it is. Using the product with the monitor not properly adjusted may cause dizziness or a headache to an operator, a player, or the customers.
 - **When transporting or reselling this product, be sure to attach this manual to the product.**
In the case where commercially available monitors and printers are used in this product, only the contents relating to this product are explained herein. Some commercially available equipment has functions and reactions not stated in this manual. Read this manual together with the specific Instruction Manual of such equipment.
- Descriptions herein contained may be subject to improvement changes without notice.
 - The contents described herein are fully prepared with due care. However, should any question arise or errors be found, please contact SEGA.

INSPECTIONS IMMEDIATELY AFTER TRANSPORTING THE PRODUCT TO THE LOCATION.

Normally, at the time of shipment, SEGA products are in a status allowing for usage immediately after transporting to the location. Nevertheless, an irregular situation may occur during transportation. Before turning on power, check the following points to ensure that the product has been transported in a satisfactory status.

- Are there any dented portions or defects (cuts, etc.) on the external surfaces of the cabinet?
- Are Casters and Adjusters, damaged?
- Do the power supply voltage and frequency requirements meet with those of the location?
- Are all wiring connectors correctly and securely connected? Unless connected in the correct direction, connector connections can not be made accurately. Do not insert connectors forcibly.
- Do power cords have cuts and dents?
- Do the fuses used meet specified rating? Is the Circuit Protector in an energized status?
- Are all accessories available?
- Can all Doors and Lids be opened with the Accessory keys? Can Doors and Lids be firmly closed?

Initial “D” Ver. 2 Naomi 2 Software Kit Contains List

Before beginning installation, check to make sure the kit contains the following parts.
Details of the parts are given below.

Part #	Desc	Qty
999-1787	Upgrade Manual (this document)	1
610-0624-0027	GD Software Kit TOT ENG	2
422-0015B	Sticker (for shield case)	2
420-6741-02	Owner’s Manual TOT ENG2	1
601-11237-01	Card Package TOT (Initial D2) ENG	2
622-000007-EX2	Packing Set CKT-1238-G-EX1	1
421-8075-75	JASRAC Sticker TOT	2
421-11409-09	Sticker JASRAC V TOT	2
999-1788	Instruction Card TOTK	1
999-1789	Play Instructions TOTK	2
999-1790	Monitor Side Left TOTK	1
999-1791	Monitor Side Right TOTK	1
999-1792	POP Art TOTK	2
999-1793	Decal Seat Back Lower TOTK	2
999-1794	Decal Seat Back Mid TOTK	2
999-1795	Decal Seat Back Upper TOTK	2
999-1796	Decal Copyright Monitor	2

DESIGNED RELATED PARTS

999-1788
Instruction Card TOTK →



← 999-1789
Play Instructions TOTK



999-1790 →
Monitor Side Left TOTK



← 999-1791
Monitor Side Right TOTK





← 999-1792
POP Art TOTK



999-1793 →
Decal Seat Back Lower TOTK



← 999-1794
Decal Seat Back Mid TOTK

999-1795 →
Decal Seat Back Upper TOTK



← 999-1796
Decal Copyright Monitor TOTK

All manufacturers, cars, names, brands and associated imagery featured in this game are trademarks and/or copyrighted materials of their respective owners. All rights reserved.

Official Honda Licensed Product. The game features trademarks, copyrighted material, and/or automobile designs of cars actually produced and/or distributed by Honda Motor Co., LTD (Japan) All rights reserved.

UPGRADING



Perform all operations with the power switch turned off. Failure to do so may result in electrical shock and/or short circuiting. In addition, working with the power turned on may result in fingers becoming caught and injured in the spinning fan motor.

REPLACING THE KEY CHIP AND GD-ROM

Follow the steps listed below to replace the Key Chip and GD-ROM with the ones included in this kit

- Turn off the power.
- Remove the truss screws (one each) from the left and right sides of the base lid R.
- Unlock the lid using the master key.
- Turn the lock handle on the base lid R to release the latch.
- Tilt and let the seat rest on its backrest. Taking care not to damage the seat, gently lower until the backrest rests on the floor. If the floor surface is hard, spread a cloth or towel on the floor to protect the surface of the sheet from scratching.

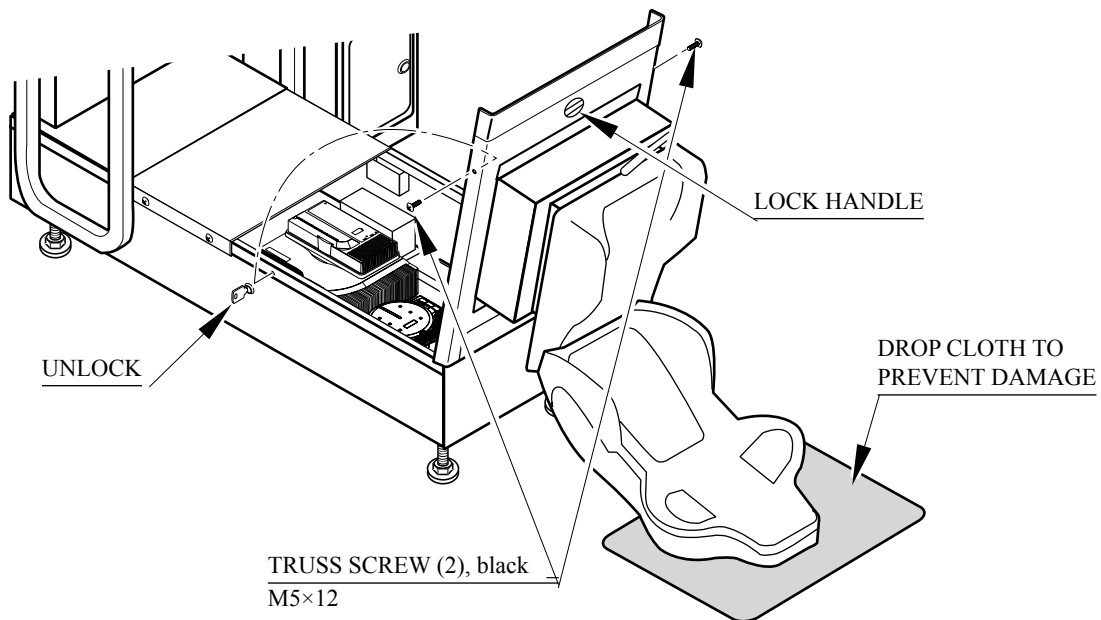

FIG. 2. 1

Replacing the Key Chip



- The Key Chip is a precision part. Exposure to heat or static electricity or collision with another object may damage it. Be sure to handle it with care.
- The Key Chip must be used in conjunction with the game GD-ROM disc contained in the same package.

- Using the cabinet's NAOMI Network System Service Manual as reference, remove the existing Key Chip from the game board and replace it with the Key Chip included in the kit.
- Affix the sticker (442-00115B) contained in the kit to the DIMM board case in the position indicated by the diagram.

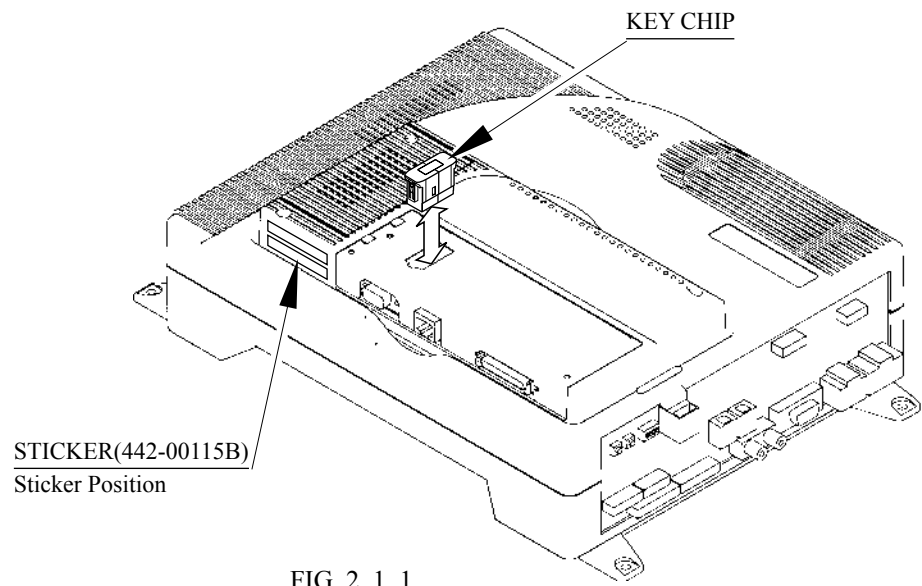
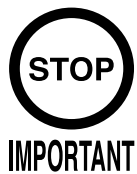

FIG. 2. 1. 1

Replacing the GD-ROM



- Handle the surface of the GD-ROM disc and the reader lens of the GD-ROM drive with care to protect them from dirt and dust.
- Do not use the GD-ROM disc if the surface has been scratched. Using a scratched disc may cause the GD-ROM drive to malfunction.
- Be sure to place the GD-ROM disc into the GD-ROM drive with the label side facing up.

Using the cabinet's NAOMI Network System Service Manual as reference, remove the existing GD-ROM disc from the GD-ROM drive and replace it with the disc included in the kit.

CONFIRMING THE UPGRADE

Using the "Explanation of Test and Data Display" section of the instruction manual contained in the kit as reference, check to make sure that the upgrade has been performed correctly and that all systems are working properly. Be sure to adjust the monitor to correct for any flickering or distortion before operating the product. Refer to the "Monitor" section of the instruction manual included in the kit for details.

Game Overview

Game Overview

The game is a car racing game with three different game modes: "Legend of the Streets", "Time Attack" and "The Bunta Challenge!". By connecting two units, you can also enjoy "Network Battle Game" play. The card system allows players to store information such as the car, wins/loss records and car tune-up status on a special card.

Legend of the Streets

● Game Content & Rules

Battle rival characters man to man on 6 different courses. Each checkpoint you pass adds time to the overall time limit. The first one across the finish line with the allotted time wins. If you run out of time or cross the finish line second, you lose. Once you've defeated all 24 rival characters, you'll get a chance to race against a hidden rival character (final battle/race). Defeat him and you'll race for the title of street legend against the last hidden rival character (special battle/race). Only when the title is yours will you get to see the ending.

● INITIAL D CARD

Purchasing a card when you start the game creates your car. The card can store all the data for one car. Information on the card includes the player name, car, tune-up status, names of defeated rival characters, times from Time Attack mode, Network Game records, passwords from Time Attack mode and more. On the Card Screen, the player's name, car name, cleared areas, Key and Speed Demon Level are displayed. The Key is necessary when recording results on the Net Rankings. Speed Demon Level stars (★) increase as various conditions are cleared.

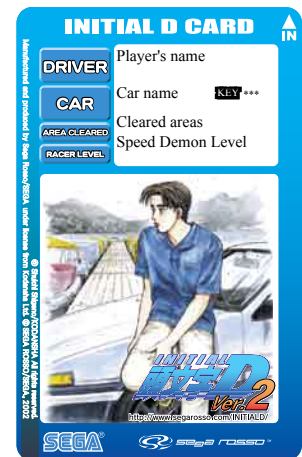

● Car Tune-Ups

Depending on how well you do, points are added to your card when you use it to play in "Legend of the Streets", "Time Attack", "The Bunta Challenge!" and "Network Battle Race" modes. When you've accumulated enough points, you are given the option of using those points to do tune-ups on your car to increase performance.

- Game Flow

- Accept Challenger Screen, Battle Race Select Screen:

When network play is disabled, this screen will not appear.

For a 1-player game only, select "Refuse Challengers" or "Do Not Enter".

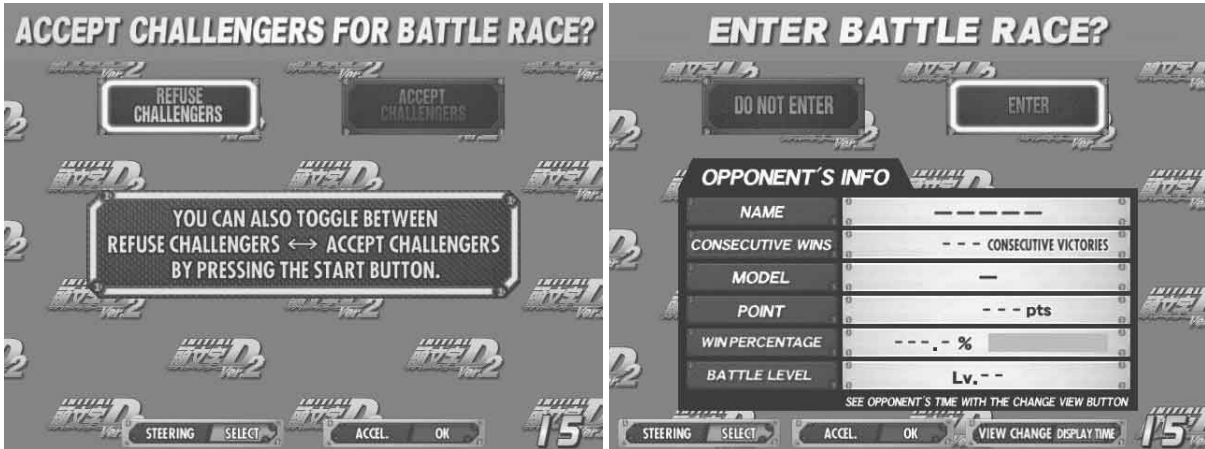

- Card Entry Screen and Card Purchase Screen:

Insert your card if you've got one after completing the Card Purchase Screens. If you don't already have a card, you can purchase one.



- Vehicle Selection Screen:

This screen isn't displayed if you've already purchased a card.



- **Transmission Selection Screen:**
This screen isn't displayed if you've already purchased a card.



- **Parts Option Selection Screen:**
If you're purchasing a card, select one of the Parts option. These parts are then attached to your car when you accumulate enough points.



- **Name Entry Screen:**
If you're purchasing a card, enter your name (driver's name) at the player name input screen.



- Mode Select Screen:
Select "Legend of the Streets"
at the Mode Selection Screen.



- Course and Rival Character Selection Screens

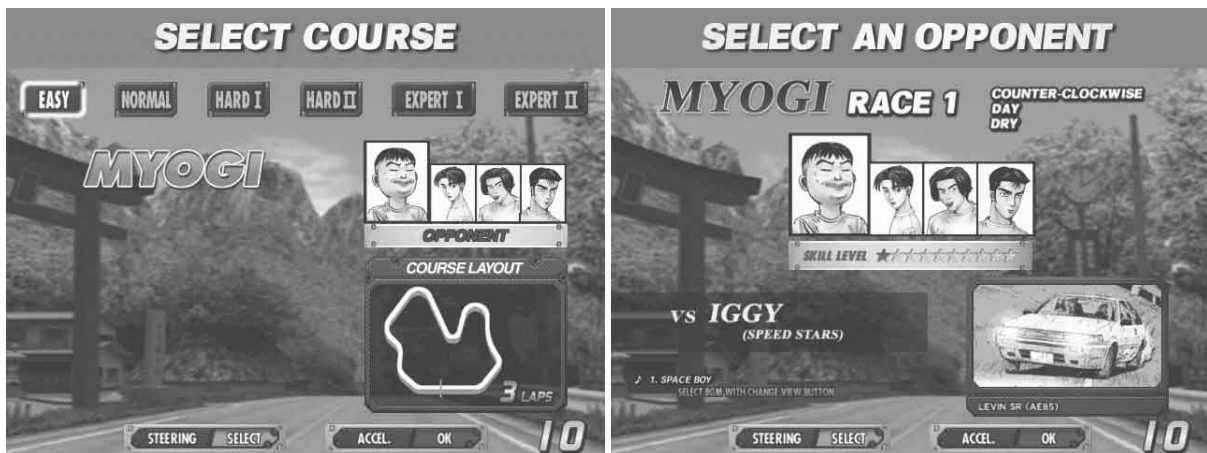

- Rival Character Scenes



- Battle (Race)



- Results Screen



- Tune Up Screen:
Use your card to play and accumulate points you can put towards performance enhancing tune-ups.



- **Continue Screen:**
Choose to continue or quit after rival character scenes. If you select "YES", nothing is recorded to the card and you can continue playing. If you select "NO", your game data is stored on your card and your game ends.



Time Attack

- **Game Content & Rules**

This is a race against time. The goal is to cross the finish line as quickly as you can. "Direction", "Time of Day" and "Weather" can be selected for each of the six courses - note that on the highest level (Expert 1) time can only be set to Night. Each checkpoint you pass adds time to the overall time limit. When you cross the finish line, a password is displayed. You may use this password to participate in the online Internet rankings.

Note: In order to register the password, you must have played the game with a card and you'll need to enter the 3 digit number of KEY printed on the front of the card.

Four Courses Runaround: A new Time Attack challenge available when the player spends 60000 points from the total saved on their Card. Weather option may be changed. Player races in order through these courses: Akagi (single Downhill), Akina (single Downhill), Happogahara (single Inbound) and Irohazaka (single Downhill).

Your times, when recorded with the card (or tuned car), are displayed in the "TUNED" ranking. Your time, when not using a card, are displayed in the "NORMAL" ranking. The only way to accumulate points is to play with a card.

The BUNTA Challenge!

- **Game Content & Rules**

Race head-to-head against a single rival (BUNTA), on four different courses: Akagi, Akina, Happogahara and Irohazaka

For each course, only Dry or Night conditions may be selected.

A Card with saved points is necessary to play.

Player must finish ahead within the time limit to win.

Finishing behind or over the time limit means the player loses.

Beating Bunta earns points and increases the Bunta Level for that course by one.

The Bunta Level indicates Bunta's strength; the higher the level the stronger he becomes.

Losing reduces the player's points total.

Network Battle Race

● Game Content & Rules

Two vehicles race for victory.

When either car passes a checkpoint, remaining race time will be increased.

The winner is the car that crosses the finish line first or is occupying first place when time runs out.

A car built on the Card (Custom Car) may also be used.

When racing with a Custom Car, results will be saved on the Card.

Challengers may challenge at any point during the champion side race.

Cards may not be purchased during a Network Battle Race.

Before the Race

[Champion Side]

● Battle Entry Challenge Request Screen

When a challenge occurs before the start of the race (during selection phase):

If the challenge occurs before the mode selection phase (during Car Selection etc), the Network Battle Race Information Screen is displayed directly before the selection phase.

If the challenge occurs after the selection phase, selection is interrupted and the Network Battle Race Information Screen is displayed.

When a challenge occurs during the race:

The race is interrupted and the Network Battle Race Information Screen is displayed.



- Network Battle Race Information Screen

The challenger selects the course while the champion waits at the Network Battle Race Information Screen.



[Challenger Side]

- Network Battle Race Select Screen

This screen asks if a new player wishes to enter a Battle Race. It only appears when a new player first inserts coins and the current player has opted to accept Battle Race challengers.



- Card Entry Screen

When a Battle Race is established, the Card Entry Screen appears. A Battle can be raced even without a Card.

If there is no Card, the game proceeds to the Car Selection and Transmission Selection Screens. The Course Selection Screen then appears. The challenger selects the course.



After the Race

● Results Screen

After a battle, the Results Screen appears.

Depending on the results, the Battle Level will change.



Result	
BATTLE RESULT	WIN
TOTAL TIME	3'05"728
LAP TIME	1 1'07"674
	2 0'58"914
	3 0'59"139
ADVANTAGE	+ 195.7m
Point	
BATTLE POINTS	1000pts
VICTORY BONUS	2000pts
ADVANTAGE BONUS	195pts
PTS. ACQUIRED	3195pts
TOTAL POINTS	6389pts

● Continue Screen

The winning player will receive victory points and will be allowed to continue play.

The losing player will go to the Continue Screen.

When the number of victories exceeds the set limit

When a player's total number of victories exceeds the set limit, the player will be taken to the Continue Screen even if they win. (See Section "10-3 F".)

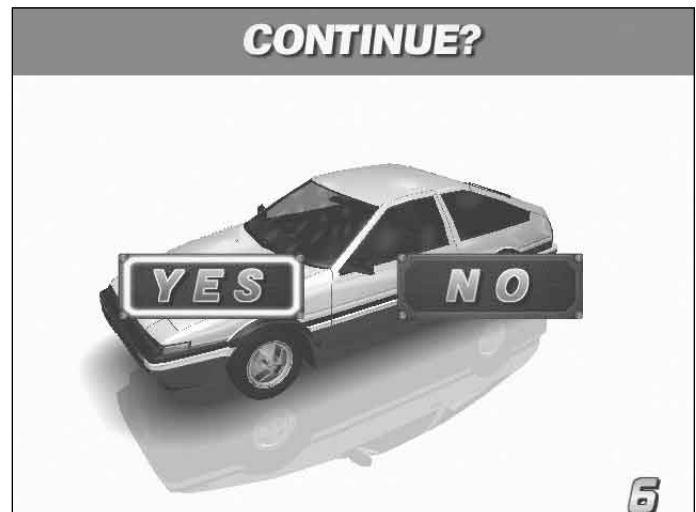

Configuration

When a Card is inserted, a number of options may be set.

Press the View Change Button at the Card Data Confirmation Screen to go to the Configuration screen. When displaying the configuration Screen, you can select the item by the Shift Lever. After selecting the item, press the Start Button and change the setting by the Steering Wheel. After changing the setting, press the Start Button again to be settled the new settings.



- **BGM**
Set race background music options
On: Play BGM as normal (Default Setting).
Off: Turn BGM off.
Fix: Play the melody selected at Song Selection. Will play the same BGM until changed.
- **Navigation Display**
Set options for the Navigation Display that appears at the lower left of the Race Screen.
On: Show navigation display (Default setting).
Off: Do not show navigation display.
Paper Cup: A paper cup full of water appears on the navigation display.
- **Steering**
Set steering wheel stiffness.
1 to 9: 1 is the loosest. Stiffness increases up to a maximum setting of 9.
(Default Setting is 5)
- **Time Display**
Set the Time Display on the Race Screen.
Normal: Standard time display. (Default setting)
Simple: Simplified time display.
- **Force Quit**
Force end of game during Legend of the Streets and Time Attack play.
Off: Disable force quit (Default setting)
On: Enable force quit. Press the Start and Change View Buttons simultaneously to end game.

Game Over

With "Legend of the Streets", "Time Attack" and "Network Battle Race" play, the Continue Screen appears after each race. If you choose not to continue, the game ends.

Transferring Old Card Data

Card data from the previous version, "Initial D" may be transferred for use with "Initial D Ver. 2". Not all player data will be transferred to the new Card.

- Transferable Data: Points, car model, player name, customization options, Auto/Manual transmission setting, number of plays till next inspection (the number of plays remaining on the Card, plus 50).
- Non-transferable Data: Tune-up (Tune-up status is returned to default, but transferred points may be used to re-tune the car), times, race results, Legend of the Streets status.

1. The player inserts coins to start.



Player inserts Card at the Card Entry Screen.

2. Player inserts credits at the Transfer Card Data Screen.

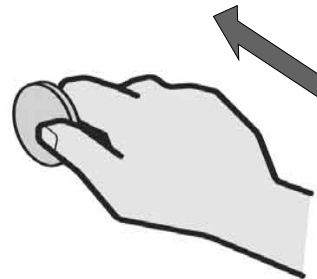

3. The old Card will be ejected. This Card can no longer be used.

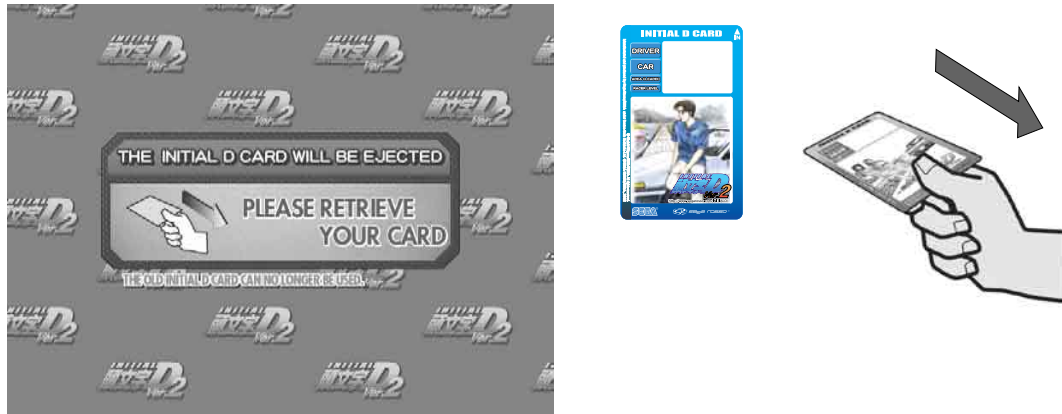

4. When the Card Data Transferred message appears, the game will restart.
The new Card is for exclusive use with the Initial D Ver. 2, and cannot be used with the previous version, Initial D.

Limit on Card Use

Each Card can be used for up to fifty plays, until Car Inspection time is reached. Continued game play after each race is not counted as part of the 50 game limit. Cards may be renewed by transferring data to a new Card (stored points will not be lost). However, if you do not renew your card at the Car Inspection, you will not longer be able to play using the data stored on your card.

Car Selections

TOYOTA
TRUENO GT-APEX [AE86]
LEVIN GT-APEX [AE86]
LEVIN SR [AE85]
MR2 G-Limited [SW20]
MR-S S EDITION [ZZW30]
ALTEZZA RS-200 [SXE10]
CELICA GT-FOUR [ST205]

NISSAN
SKYLINE GT-R V spec
[BNR32]
SKYLINE GT-R V spec
[BNR34]
SILVIA K's [S13]
SILVIA Q's [S14]
SILVIA K's AERO [S14]
SILVIA spec-R [S15]
180SX TYPE X [RPS13]
SILEIGHTY [RPS13]

HONDA
CIVIC TYPE R [EK9]
CIVIC SiR [EG6]
INTEGRA TYPE R [DC2]
S2000 [AP1]

MITSUBISHI
LANCER EVOLUTION GSR [CE9A]
LANCER EVOLUTION RS [CN9A]
LANCER EVOLUITON ZGSR [CT9A]

MAZDA
RX-7 Type R [FD3S]
RX-7 SPIRIT R Type A [FD3S]
RX-7 ∞III[FC3S]
ROADSTER S Special [NA6C]
ROADSTER RS [NB8C]

SUBARU
IMPREZA WRX STi Version Y [GC8]
IMPREZA WRX STi [GDB]

SUZUKI
Cappuccino [EA11R]

Race Courses

- Easy: Myogi, Circular Course/3 laps, Clockwise & Counter-clockwise, Day & Night, Dry & Wet
- Normal: Usui, Circular Course/2 laps, Clockwise & Counter-clockwise, Day & Night, Dry & Wet
- Hard I: Akagi, Single road, Uphill & Downhill, Day & Night, Dry & Wet
- Hard II: Akina, Single road, Uphill & Downhill, Day & Night, Dry & Wet
- Expert I: Happogahara, Outbound & Inbound, Night, Dry & Wet
- Expert II: Irohazaka, Single road, Downhill/Reverse, Day & Night, Dry & Wet

Legend of the Streets Rival Characters

- EASY (MYOGI)

IGGY	LEVIN SR [AE85]
TAK	LEVIN SR [AE85]
SHINGO	CIVIC SiR [EG6]
ZACK	SKYLINE GT-R V spec [BNR32]
- NORMAL (USUI)

TWO GUYS FROM TOKYO	SILVIA spec-R [S15]
NOBU	ALTEZZA RS-200 [SXE10]
MAYA & SIMONE	SILEIGHTY [RPS13]
SID	Cappuccino [EA11R]
- HARD I (AKAGI)

KYLIE	RX-7 Type R [FD3S]
DANNY	SILVIA Q's [S14]
K. T.	RX-7 Type R [FD3S]
RY	RX-7 ∞ III [FC3S]
- HARD II (AKINA)

KENJI	180SX TYPE X [RPS13]
COLE	SILVIA K's [S13]
AKI	LEVIN GT-APEX [AE86]
TAK	TRUENO GT-APEX [AE86]
- EXPERT I (HAPPOGAHARA)

TORU	ROADSTER SSpecial [NA6C]
DICE	CIVIC TYPE R [EK9]
SMILEY	INTEGRA TYPE R [DC2]
TOUCH	CIVIC TYPE R [EK9]
- EXPERT II (IROHAZAKA)

HAWK	LANCER EVOLUTION RS [CN9A]
KYLE	LANCER EVOLUTION GSR [CE9A]
CAINE	MR2 G-Limited [SW20]
K. T.	RX-7 Type R [FD3S]
TAK	TRUENO GT-APEX [AE86]
BUNTA	IMPREZA WRX type R STi Version [GC8]

10. EXPLANATION OF TEST AND DATA DISPLAY

By operating the switch unit, periodically perform the tests and data check. When installing the machine initially or collecting cash, or when the machine does not function correctly, perform checking in accordance with the explanations given in this section.

The following shows tests and modes that should be utilized as applicable.

This product's basic system consists of the NAOMI 2 GD-ROM game board. The system enables you to play several games one after the other just by changing a GD-ROM disc and key chip.

The product supports, therefore, the following 2 test modes:

- (1) System test mode for an automatic self-diagnostic test (generally used by every product that contains the basic system) and a coin assignment (specifically used by this product) and
- (2) Game test mode for testing the input/output control devices and setting the difficulty level (specifically used by this product).

This manual does not cover the automatic self-diagnostic test. For more information about the system test mode, see the attached NAOMI NETWORK SYSTEM Service Manual.

TABLE 10 EXPLANATION OF TEST MODE

ITEMS	DESCRIPTION
INSTALLATION OF MACHINE	When the machine is installed, perform the following: <ol style="list-style-type: none"> 1. Check to ensure each is the standard setting at shipment. 2. Check each Input equipment in the INPUT TEST mode. 3. Check each Output equipment in the OUTPUT TEST mode. 4. Test on-IC-Board IC's in the SELF-TEST mode.
MEMORY	This test is automatically executed by selecting RAM TEST, or ROM BOARD TEST in the Menu mode.
PERIODIC SERVICING	Periodically perform the following: <ol style="list-style-type: none"> 1. MEMORY TEST 2. Ascertain each setting. 3. To test each Input equipment in the INPUT TEST mode. 4. To test each Output equipment in the OUTPUT TEST mode. 5. CARD R/W TEST
CONTROL SYSTEM	<ol style="list-style-type: none"> 1. To check each Input equipment in the INPUT TEST mode. 2. Adjust or replace each Input equipment. 3. If the problem still remains unsolved, check each equipment's mechanism movements.
MONITOR	In the Monitor Adjustment mode, check to see if Monitor (Projector) adjustments are appropriate.
IC BOARD	MEMORY TEST
DATA CHECK	Check such data as game play time and histogram to adjust the difficulty level, etc.

SYSTEM TEST MODE



- The contents of settings changed in the TEST mode are stored when the test mode is finished from EXIT in the menu mode. If the power is turned off before the TEST mode is finished, the contents of setting change become ineffective.
- Executing "BACKUP DATA CLEAR" in the SYSTEM TEST MODE does not clear the BOOKKEEPING data in the GAME TEST mode.
- Entering the TEST mode clears fractional number of coins less than one credit and BONUS ADDER data.
- Perform setting as per specified in this manual for operation. If setting not specified is performed for operation, proper function of this product may not be obtained.

In the SYSTEM TEST MODE, IC BD functioning can be checked, the monitor adjusted, and the coin setting performed.

Refer to NAOMI NETWORK SYSTEM SERVICE MANUAL for the details. Note that the setting of the following items need to be performed in accordance with the instruction given.

- CABINET TYPE: 1 PLAYER(S)
- MONITOR TYPE: HORIZONTAL
- SERVICE TYPE: COMMON
- COIN CHUTE TYPE: COMMON
- NETWORK TYPE: NONE

The SEQUENCE SETTING items of COIN/CREDIT SETTING are as follows.

- SEQUENCE SETTING
 - SEQUENCE 1: Number of credits required for starting the game.
 - SEQUENCE 2: Number of credits required for continuing the play.
 - SEQUENCE 3: Number of credits required for dedicated CARD purchase.
 - SEQUENCE 4~8: NOT USED

GAME TEST MODE



- When changing the game configuration, changes will not take effect until the Game Test Mode has been completed. Be sure to exit the Game Test Mode properly after configuration changes.
- Do not configure the game in ways not described in this text. It is possible that the game will not function properly.

GAME TEST MENU MODE

Select GAME TEST MODE from the System Menu screen to display the Game Test Menu screen.

Use the SERVICE Button to move the cursor to the desired test item.
Press the TEST Button to enter the selected item.

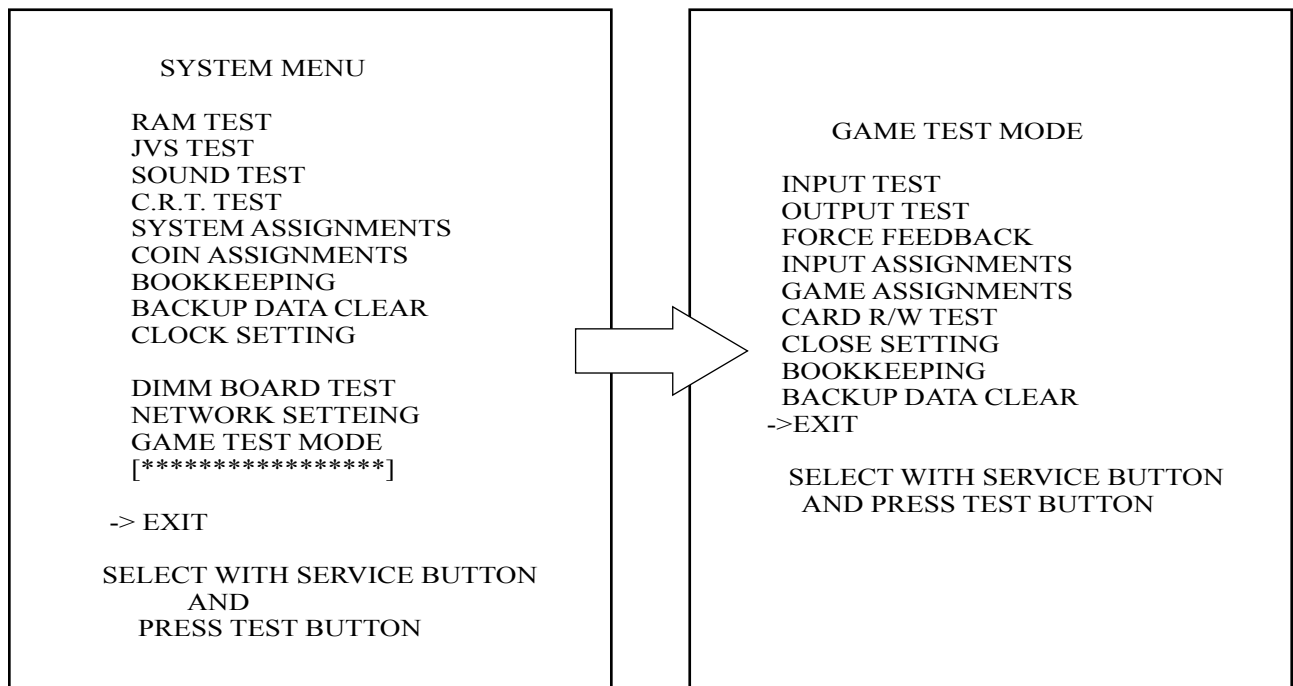

SYSTEM TEST MODE MENU Screen

GAME TEST MENU Screen

After making changes, be sure to select EXIT and press the TEST Button in order to enable the new settings.

Move the cursor to EXIT and press the TEST Button to return to the System Menu screen.

INPUT TEST

Select INPUT TEST to display the following screen and check the status of input devices. This test should be used periodically to check that each input device is functioning correctly.

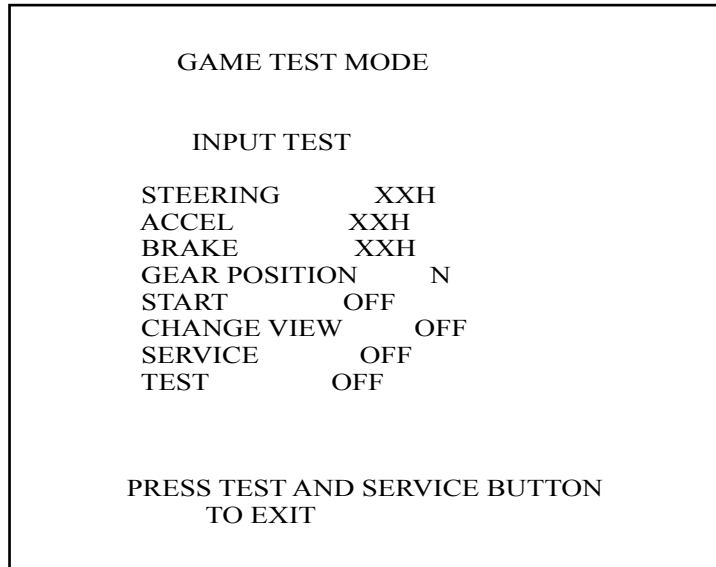
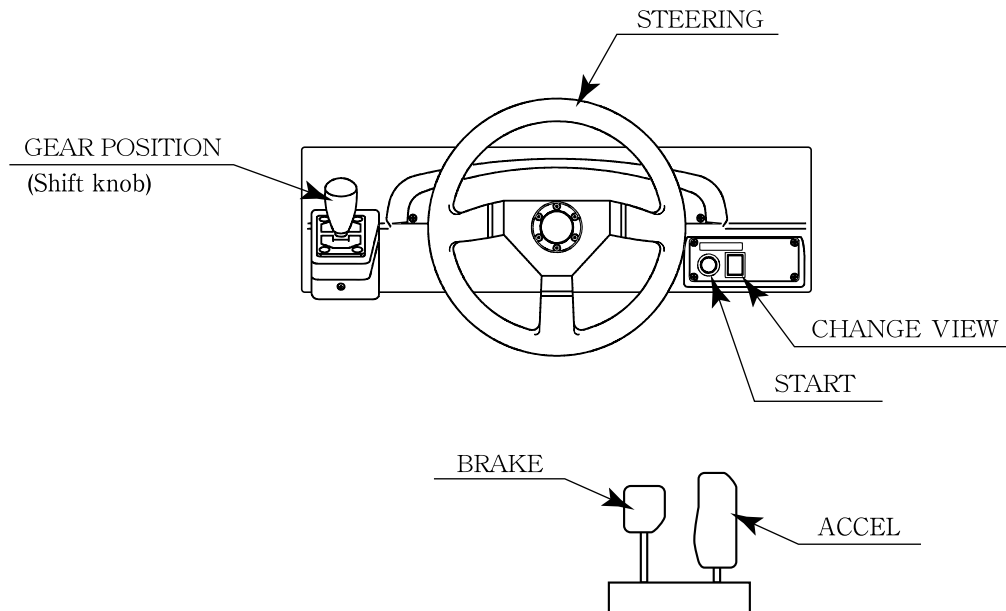

FIG. 10. 3 b INPUT TEST Screen

Test the STEERING, ACCEL and BRAKE controls to ensure that they are functioning properly and that the parameters change smoothly as each input device is operated.

Display N, UP and DOWN using the GEAR POSITION. N should display there is no control input. Verify that both UP and DOWN display in sync with the position of the shift knob.

Press the START, CHANGE VIEW, SERVICE and TEST Buttons. If functioning correctly, each indicator will switch from OFF to ON.



Press the SERVICE and TEST Buttons simultaneously to return to the Game Test Menu screen.

OUTPUT TEST

Select OUTPUT TEST to display the following screen and check the status of each lamp. This test should be used periodically to check that the lamps are functioning correctly.

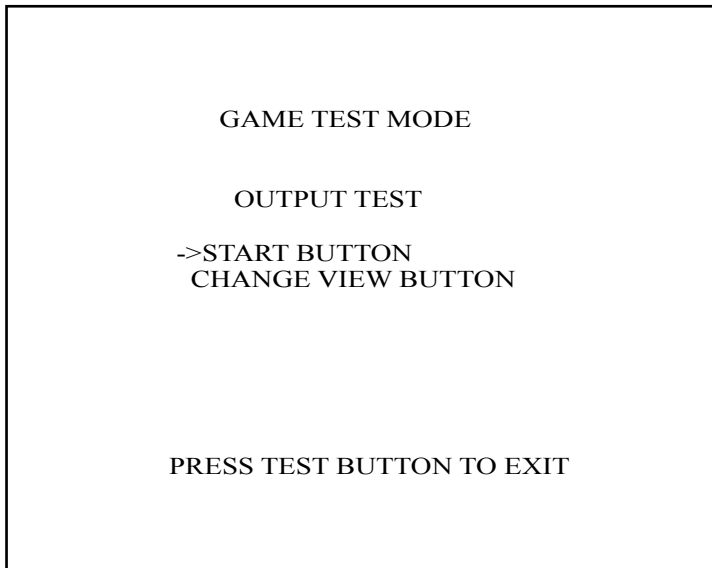

FIG. 10. 3 c OUTPUT TEST Screen

The cursor toggles automatically between START Button and CHANGE VIEW Button, and each lamp lights up.

Press the TEST Button to return to the Game Test Menu screen.

FORCE FEEDBACK



If you select FORCE FEEDBACK, the STEERING will rotate automatically when you press the TEST Button. The STEERING will also rotate automatically during FORCE TEST. Make sure that no one is touching the STEERING before running these tests as contact may cause injury.

When you select "FORCE FEEDBACK", a connection test runs and the STEERING rotates. When the connection check completes, a screen similar to the one below is displayed, and you may adjust the STEERING resistance.

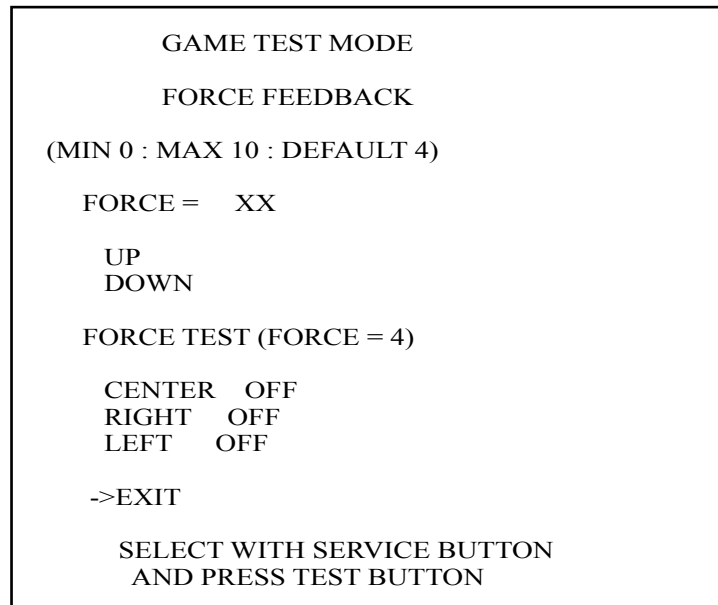

FIG. 10. 3 d FORCE FEEDBACK Screen

- **FORCE:** Set the STEERING resistance
The smaller the value, the weaker the resistance; the larger the value, the stronger the resistance.
(Minimum value is 0; the maximum value is 10. The default setting is 4.)
Move the cursor to UP or DOWN and press the TEST Button to change the value.
- **FORCE TEST:** Verifies the STEERING motor is working properly
Conducted when the STEERING resistance is set at 4.
Toggle between OFF and ON by aligning to CENTER and pressing the TEST Button.
The STEERING will rotate and stop in the center position. Pressing the SERVICE Button moves the cursor to the next menu item and CENTER changes to OFF. Control of the STEERING is then released.
When the RIGHT menu item is ON, the STEERING rotates to the right as far as possible and then stops. Press the SERVICE Button again to turn it OFF and release control of the STEERING.
When the LEFT menu item is ON, the STEERING rotates to the left as far as possible and then stops. Press the SERVICE Button again to turn it OFF and release control of the STEERING.

Move the cursor to EXIT and press the TEST Button to return to the Game Test Menu screen.

INPUT ASSIGNMENTS

Select INPUT ASSIGNMENTS to display the following screen.

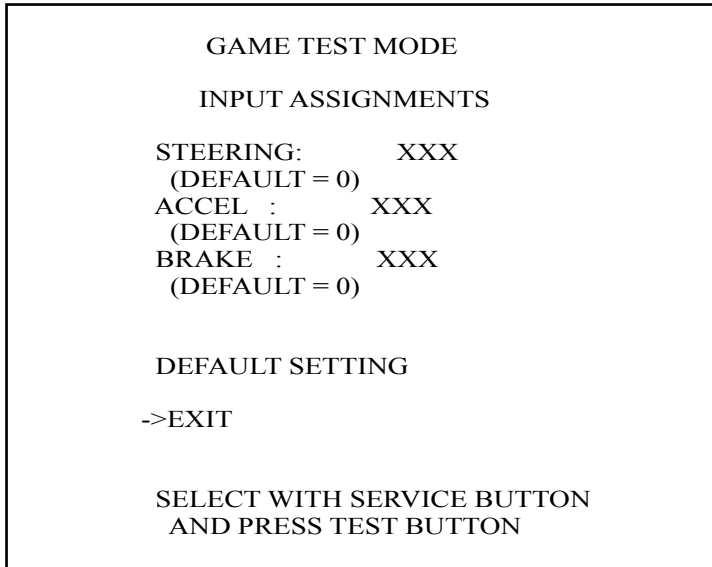

FIG. 10. 3 ea INPUT ASSIGNMENTS Screen

You can adjust each of the menu items by moving the cursor to the menu item and pressing the TEST Button.

Return all settings to the default settings with DEFAULT SETTING.

- STEERING: Make adjustments to STEERING
Press the TEST Button to display the following screen.

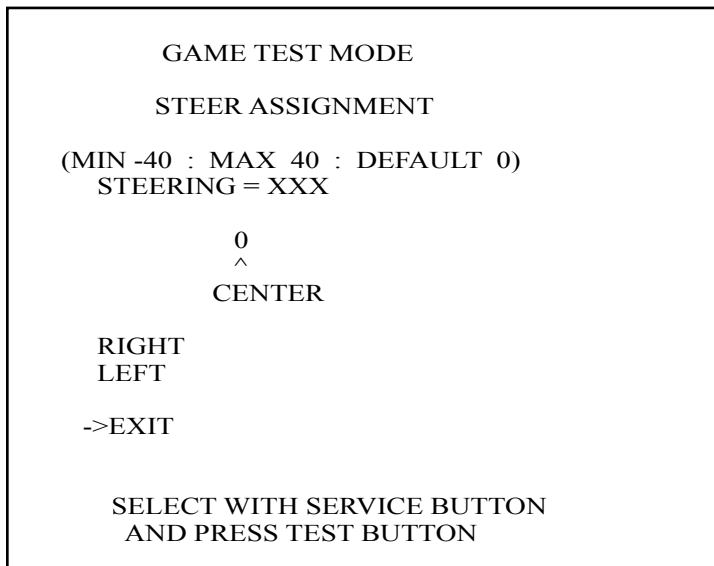

FIG. 10. 3 eb STEER ASSIGNMENTS Screen

Center the STEERING. When the "0" displayed is not exactly aligned with the "^" mark above CENTER, use the cursor to select RIGHT or LEFT and move the "0" until it is displayed directly above the "^" mark. Move the cursor to RIGHT and press the TEST Button to move the "0" to the right. Each time you press the TEST Button, "0" moves slightly to the right. Move the cursor to LEFT and press the TEST Button to move the "0" to the left. Each time you press the TEST Button, "0" moves slightly to the left.

Move the cursor to EXIT and press the TEST Button to return to the INPUT ASSIGNMENTS screen.

- ACCEL: Make adjustments to ACCEL
Press the TEST Button to display the following screen.

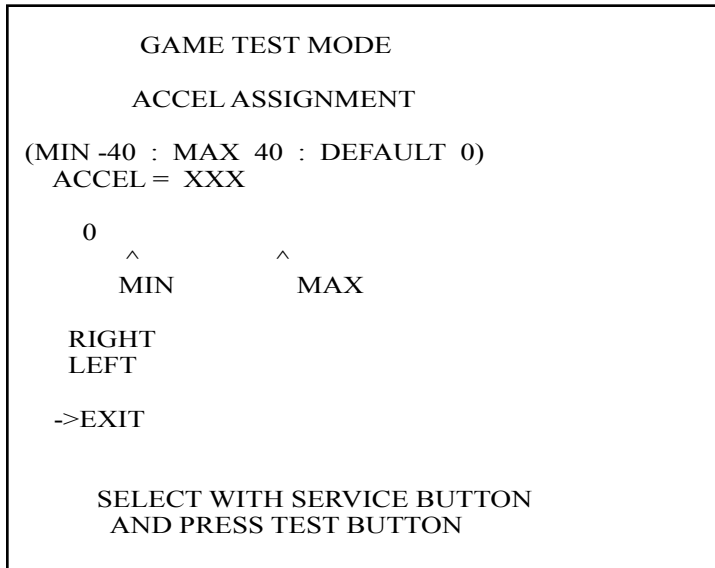

FIG. 10. 3 ec ACCEL ASSIGNMENTS Screen

Adjust the distance between "0" displayed and the "^" mark equally so that when your foot is off the ACCEL pedal, the "0" on the left is aligns with the "^" above MIN and when you press the ACCEL pedal down all the way, the "0" on the right is aligns with the "^" mark above MAX.

Move the cursor to RIGHT and press the TEST Button to move "0" to the right. Each press of the TEST Button moves "0" slightly to the right.

Move the cursor to LEFT and press the TEST Button to move "0" to the left. Each press of the TEST Button moves "0" slightly to the left.

Move the cursor to EXIT and press the TEST Button to return to the INPUT ASSIGNMENTS screen.

- BRAKE: Make adjustments to BRAKE
Press the TEST Button to display the following screen.

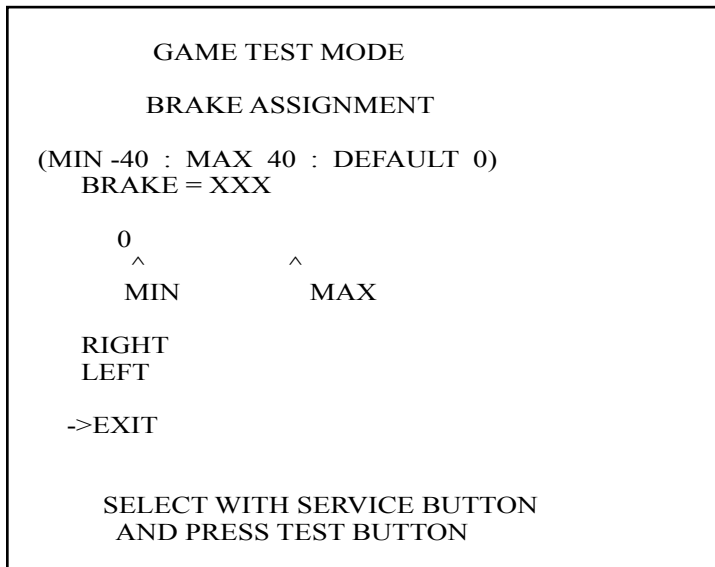

FIG. 10. 3 ed BRAKE ASSIGNMENTS Screen

Adjust the distance between "0" displayed and the "^" mark equally so that when your foot is off the BRAKE pedal, the "0" on the left is aligns with the "^" above MIN and when you press the BRAKE pedal down all the way, the "0" on the right is aligns with the "^" mark above MAX.

Move the cursor to RIGHT and press the TEST Button to move "0" to the right. Each press of the TEST Button moves "0" slightly to the right.

Move the cursor to LEFT and press the TEST Button to move "0" to the left. Each press of the TEST Button moves "0" slightly to the left.

Move the cursor to EXIT and press the TEST Button to return to the INPUT ASSIGNMENTS screen.

GAME ASSIGNMENTS

Select GAME ASSIGNMENTS to display the current game settings and make changes.

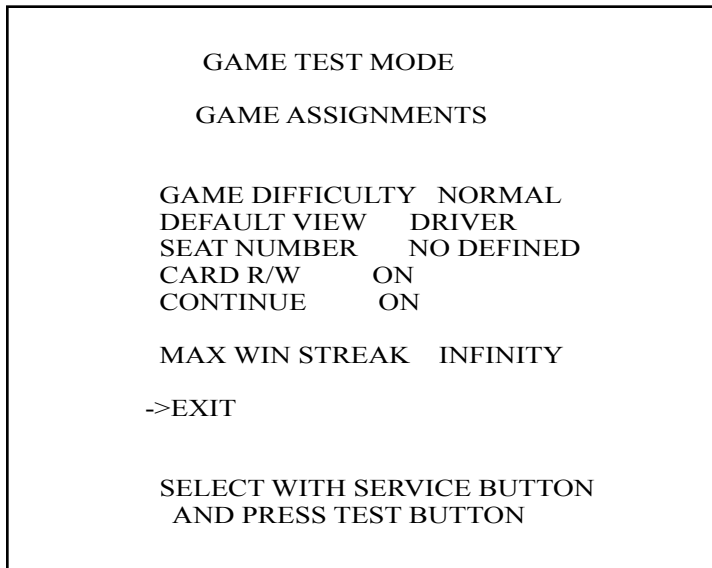

FIG. 10. 3 f GAME ASSIGNMENTS Screen

The GAME DIFFICULTY and CONTINUE menu items can be set only when the SEAT NUMBER is set to either 1 or NO DEFINED. The MAX WIN STREAK menu item can be set only when the SEAT NUMBER is set to 1.

- **GAME DIFFICULTY:** Set the level of difficulty for the game
You may select one of 5 different levels of difficulty: VERY EASY, EASY, NORMAL, HARD or VERY HARD.
This setting does not affect the speed of rivals in "Legend of the Streets" mode.
- **DEFAULT VIEW:** Set the view perspective at the start of races
You may select one of the following 2 settings: DRIVER view or REAR view.
- **SEAT NUMBER:** Assign seat numbers to seats in each arcade unit for network play
If you have two arcade units side by side, make sure you assign different seat numbers; the seat on the left would be 1 and the one on the right would be 2. If the unit will not be used for network play, set the SEAT NUMBER to NO DEFINED.
You may select one of the following 3 settings: 1, 2 or NO DEFINED.
- **CARD R/W:** Set to ON if using the Card Reader/Writer.
Set to OFF when not using the Card Reader/Writer.
- **CONTINUE:** Enable/Disable Continue function.
ON: Enables Continue for Legend of the Street Time Attack and Network Battle Race games.
OFF: Disable Continue.
- **MAX WIN STREAK:** Set maximum possible wins in the Battle Race game
1/3/5/10/20/30: Causes the continue screen to appear when the number of wins exceeds the indicated limit.
INFINITY: Play continues without inserting new coins as long as the player continues to win.

Changes to settings are not enabled until Test Mode is exited. After changing settings, be sure to exit Test Mode.

After changing the settings, select EXIT and press the TEST Button to return to the Game Test Menu screen.

CARD R/W TEST



Clean the card reader/writer periodically.

Test the functionality of or clean the CARD R/W (read/writer).
The CARD R/W should be tested and cleaned periodically.

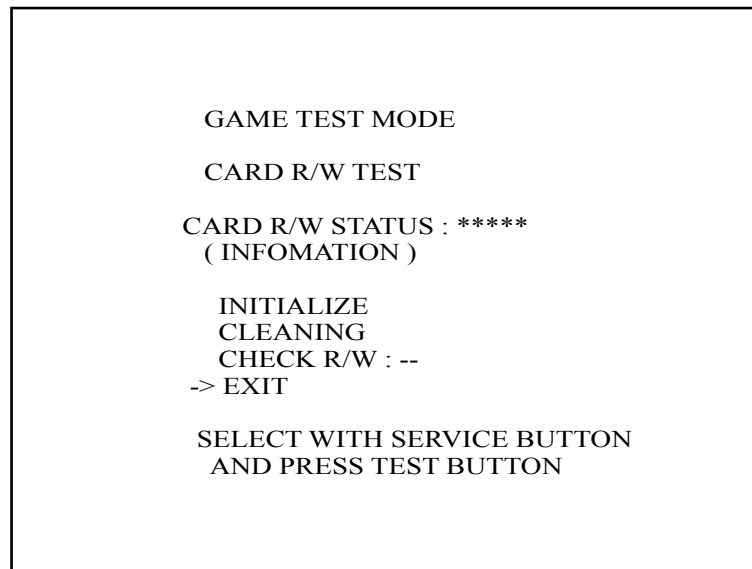

FIG. 10. 3 g CARD R/W TEST Screen

The cursor can move to the following items:

- INITIALIZE: Initialization
- CLEANING: Cleaning
- CHECK R/W: R/W Operation Check

Move the cursor to EXIT and press the TEST Button to return to the Game Test Menu screen.

Depending on the R/W running mode, one of the following is displayed in "*****" in "CARD R/W STATUS : *****":

READY Now waiting (Clear to Send Command)
INITIAL Now initializing (Not Clear to Send Command)
CLEAN Now cleaning (Not Clear to Send Command)
GET Cards are being taken out from the dispenser (Not Clear to Send Command)
SAVE Sample data is saved onto the card (Not Clear to Send Command)
PRINT Sample data is printed onto the card (Not Clear to Send Command)
LOAD Load card data and compares it with sample data (Not Clear to Send Command)
OUT Eject cards (Not Clear to Send Command)
SHUTTER Now closing/opening the shutter (Not Clear to Send Command)
ERROR Error (Clear to Initialize Command Only)

While a status with a note of "Not Clear to Send Command " in parentheses is on-screen, no operations are accepted. If such a status has occurred, wait until the operation in that status stops automatically and the display comes to READY.

Occasionally, the "INFORMATION" field on the screen outputs one of the instructions below. It usually displays nothing (blank), although it displays NO ERROR when each item is completed normally.

While cleaning is in progress, waiting in the ready mode for inserting a cleaning card:

-- PLEASE INSERT CLEANING CARD --

After the operation check, waiting for the ready mode for ejecting the card:

-- PLEASE REMOVE --

When an error occurs, its type are displayed in the "INFORMATION" field:

NO ERROR Nomal Completion
CAN'T LOAD Loading Error
CAN'T SAVE Writting Error
DRAW CARD ERROR Error in Taking Card from dispenser
CARD STUFFED Card Jamming
SHUTTER ERROR Shutter Error
WRONG DATA Data Error, Dispenser Card Empty
CONNECTION ERROR Connection Error
SCIF ERROR RC-232C Communication Error
UNKNOWN EROR Unknown Error

The "---" field in "CHECK R/W : ---" shows the result of the operation check.

--- Not Checked
OK No Failure
NG Failure

CLEANING PROCESS

Cleaning refers to the optional cleaning of the heads on the CARD R/W.
Refer to section <7-2> Head Cleaning for details on the use of the cleaning card.

- Select "CLEANING" and press the TEST Button.
- If the CARD R/W is not initialized, it will be initialized first. :INITIALIZE is displayed.
- The following message appears to show that the R/W is ready for insertion of the cleaning card:
-- PLEASE INSERT CLEANING CARD --
- Insert the cleaning card into the R/W.
On the screen, the status display is replaced with "CLEAN", and cleaning begins.
- Once cleaning ends after a lapse of a certain time, the R/W automatically ejects the card.
The status display changes from "CLEAN" to "READY."
NO ERROR is displayed on the screen.

TESTING FUNCTIONALITY

The operation check takes out each card from the dispenser, and writes the sample data onto it. The check then loads and reads it, and checks whether the read data matches the sample data. Then, the check ejects the card. When you draw out the card at this time, the entire process of the check is completed. The functionality test uses 1 card from the dispenser.

- Select "CHECK R/W" and press the TEST button.
R/W operates automatically as follows:
- If the CARD R/W is not initialized, it will be initialized first. :INITIALIZE is displayed.
- Close the shutter: SHUTTER is displayed.
- Takes out the card from the dispenser: GET is displayed.
- Saves the sample data onto the card: SAVE is displayed.
- Print the sample data onto the card: PRINT is displayed.
- Loads the data on the card for comparison with the sample data: LOAD is displayed.
- Open the shutter: SHUTTER is displayed.
- Ejects the card: OUT is displayed.
- Draws out the card. Now the entire process of the check is completed.

If execution of the operation check results in display of NG, check the error condition. If you can take action against the error, execute the operation check again after you take the proper action.

If you cannot take action against the error, repeat the check several times. If the result of the check is still NG, clean the R/W.

If the subsequent execution of the operation check still results in NG, the R/W may be faulty.

If an error occurs, it is cleared by executing the INITIALIZE command.

Note that, when an error has occurred, the R/W only accepts this command (except EXIT).

CLOSE SETTING

Select CLOSE SETTING to display the following screen.

Change the setting for the time when the store closes.

The game will be unusable for card play starting 15 minutes before the time you set until 6:00 AM the next morning. Before the store closing time, be sure to pay attention to the players with the card.

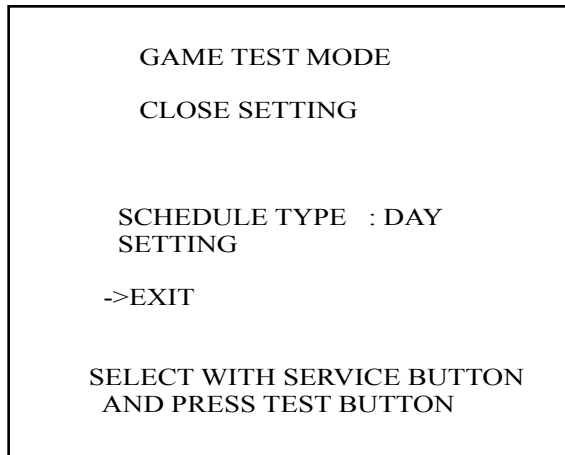

FIG. 10. 3 ha CLOSE SETTING Screen

You can set SCHEDULE TYPE to DAY, WEEK or OFF. Press the TEST Button to select the item. (The unit is shipped with SCHEDULE TYPE set to OFF.)

Move the cursor to SETTING and press the TEST Button to display the appropriate time setting screen.

- DAY: Set the daily store closing time. This time setting will be used every day

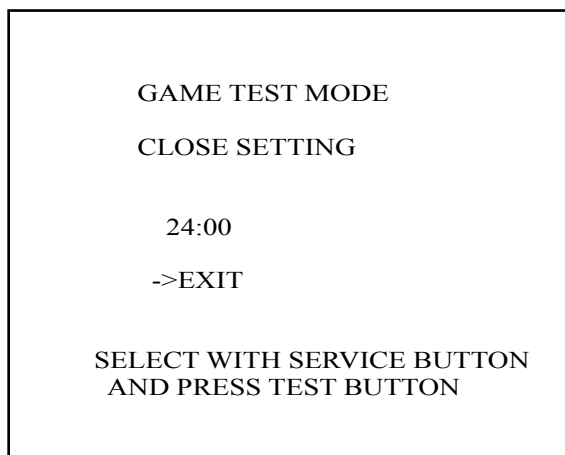

FIG. 10. 3 hb CLOSE SETTING (DAY) Screen

Set the daily store closing time. When you press the SERVICE Button, the "hour" display will begin to flash. Press the TEST Button to select any hour from "19" to "26".

Press the SERVICE Button again to accept the "hour" selection. Once accepted, the "minute" display will then begin to flash. Press the TEST Button to select one of the following "minute" options: "00, 15, 30, 45". Press the SERVICE Button again to accept the "minute" selection.

When complete, move the cursor to EXIT. If you press the SERVICE Button when the cursor is next to EXIT, the "hour" display will begin to flash again indicating that you can change the settings.

Move the cursor to EXIT and press the TEST Button to return to the CLOSE SETTING screen.

- WEEK: Set a different store close time for each day of the week

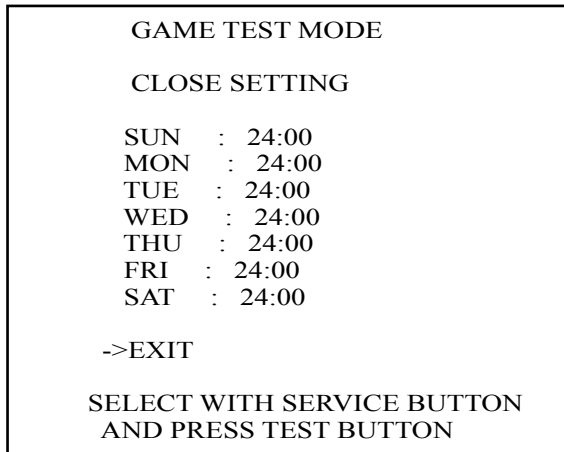

FIG. 10. 3 hc CLOSE SETTING (WEEK) Screen

Set the store closing time for each day of the week. When you press the SERVICE Button, the "hour" display will begin to flash. Press the TEST Button to select any hour from "19" to "26". Press the SERVICE Button again to accept the "hour" selection. Once accepted, the "minute" display will then begin to flash. Press the TEST Button to select one of the following "minute" options: "00, 15, 30, 45". Press the SERVICE Button again to accept the "minute" selection. Once accepted, the "hour" display for the next day of the week will begin to flash. Set the "hour" and "minute" settings in the same fashion as described above.

When you have completed setting the time for SAT, move the cursor to EXIT. If you press the SERVICE Button when the cursor is next to EXIT, the "hour" display for SUN will begin to flash again indicating that you can change the settings.

Move the cursor to EXIT and press the TEST Button to return to the CLOSE SETTING screen.

- OFF: Do not set any store closing times. Other SETTING items are not displayed

BOOKKEEPING

Select BOOKKEEPING to display the following screens of operating status data. Each time the TEST Button is pressed, the ensuing page appears. Pressing the TEST Button while the 5/5 page is displayed causes the Game Test Menu to return on the screen.

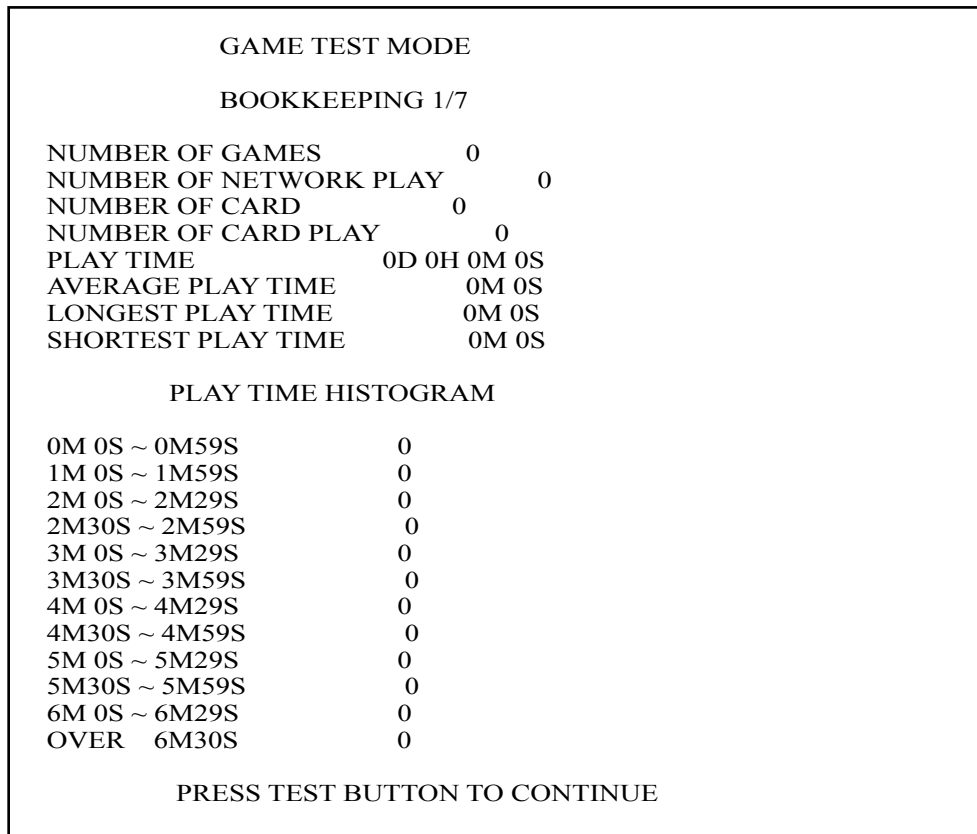

FIG. 10. 3 i BOOKKEEPING (1/7) Screen

- NUMBER OF GAMES: total number of games played
- NUMBER OF NETWORK PLAY: total number of network games played
- NUMBER OF CARD: total number of cards purchased
- NUMBER OF CARD PLAY: number of games played with cards
(selecting continue during card play gets added to this count)
- PLAY TIME: total amount of game play time
- AVERAGE PLAY TIME: average game play time
- LONGEST PLAY TIME: longest game play time
- SHORTEST PLAY TIME: shortest game play time
- PLAY TIME HISTOGRAM: table of play times

Press the TEST Button to move to screen 2/7 of BOOKKEEPING.

GAME TEST MODE	
BOOKKEEPING 2/7	
GAME / LEGEND OF THE STREETS	
MYOGI-1	0
MYOGI-2	0
MYOGI-3	0
MYOGI-4	0
USUI-1	0
USUI-2	0
USUI-3	0
USUI-4	0
AKAGI-1	0
AKAGI-2	0
AKAGI-3	0
AKAGI-4	0
AKINA-1	0
AKINA-2	0
AKINA-3	0
AKINA-4	0
PRESS TEST BUTTON TO CONTINUE	

FIG. 10. 3 i BOOKKEEPING (2/7) Screen

Press the TEST Button to move to screen 3/7 of BOOKKEEPING.

GAME TEST MODE	
BOOKKEEPING 3/7	
GAME / LEGEND OF THE STREETS	
HAPPOGAHARA-1	0
HAPPOGAHARA-2	0
HAPPOGAHARA-3	0
HAPPOGAHARA-4	0
IROHAZAKA-1	0
IROHAZAKA-2	0
IROHAZAKA-3	0
IROHAZAKA-4	0
IROHAZAKA-5	0
SPECIAL	0
PRESS TEST BUTTON TO CONTINUE	

FIG. 10. 3 i BOOKKEEPING (3/7) Screen

- GAME/LEGEND OF THE STREETS: Displays the number of times each rival character was selected in "Legend of the Street" mode. "MYOGI-1" refers to the first rival in MYOGI which is IGGY.

Press the TEST Button to move to screen 4/7 of BOOKKEEPING.

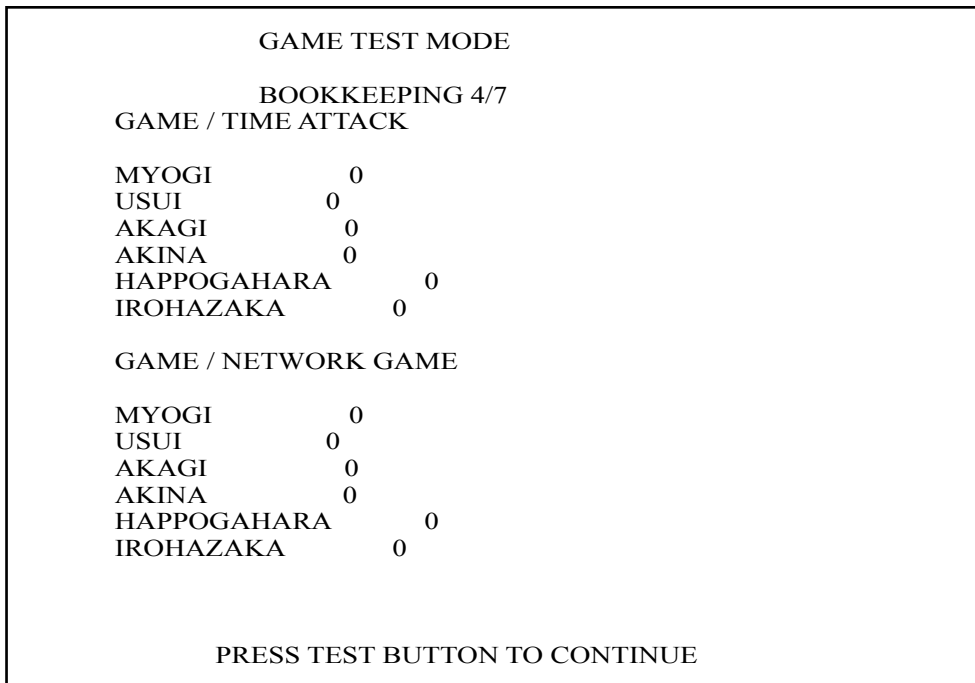

FIG. 10. 3 i BOOKKEEPING (4/7) Screen

- **GAME/TIME ATTACK:** Displays the number of times each course was selected in TIME ATTACK mode
- **GAME/NETWORK GAME:** Displays the number of times each course was selected in NETWORK GAME (VERSUS) mode

Press the TEST Button to move to screen 5/7 of BOOKKEEPING.

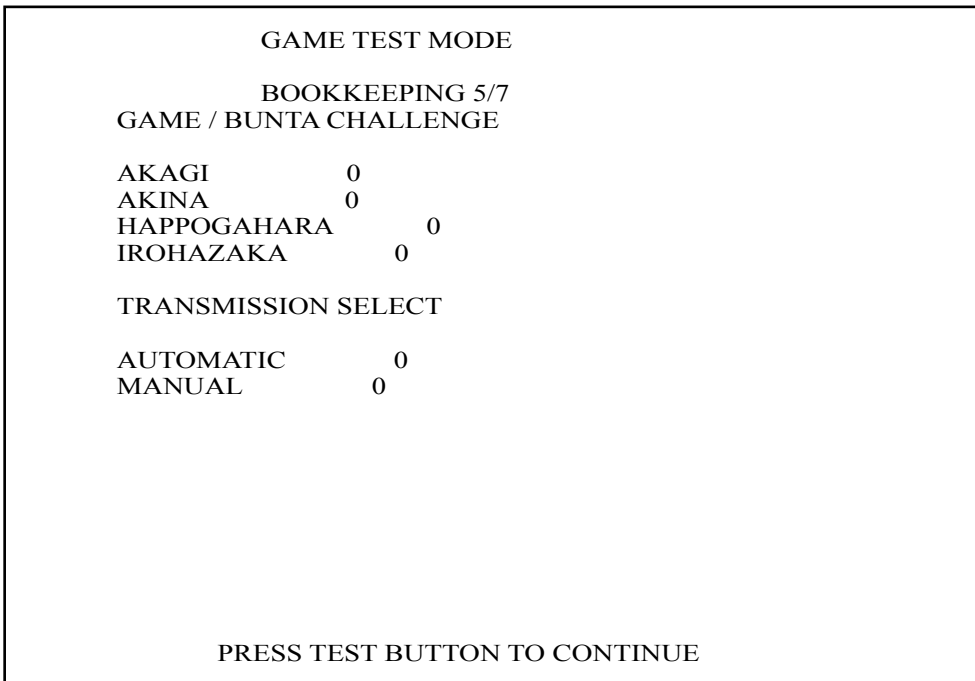

FIG. 10. 3 i BOOKKEEPING (5/7) Screen

- **GAME/BUNTA CHALLENGE:** Displays number of times each course has been selected for the Bunta Challenge.
- **TRANSMISSION SELECT:** Displays the number of times each TRANSMISSION was selected in all game modes.

Press the TEST Button to move to screen 6/7 of BOOKKEEPING.

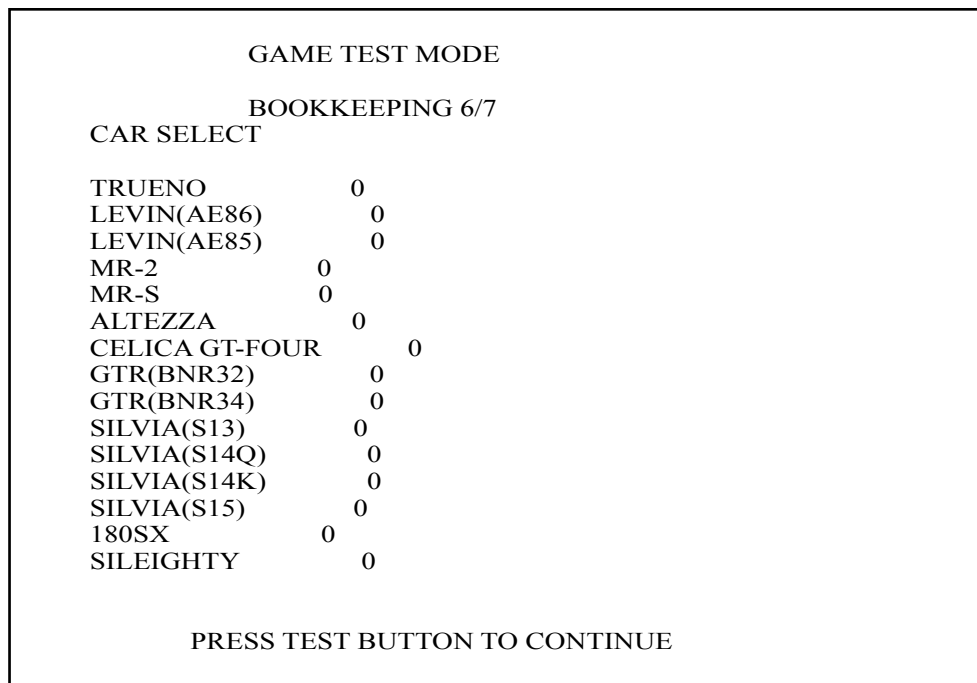

FIG. 10. 3 i BOOKKEEPING (6/7) Screen

Press the TEST Button to move to screen 7/7 of BOOKKEEPING.

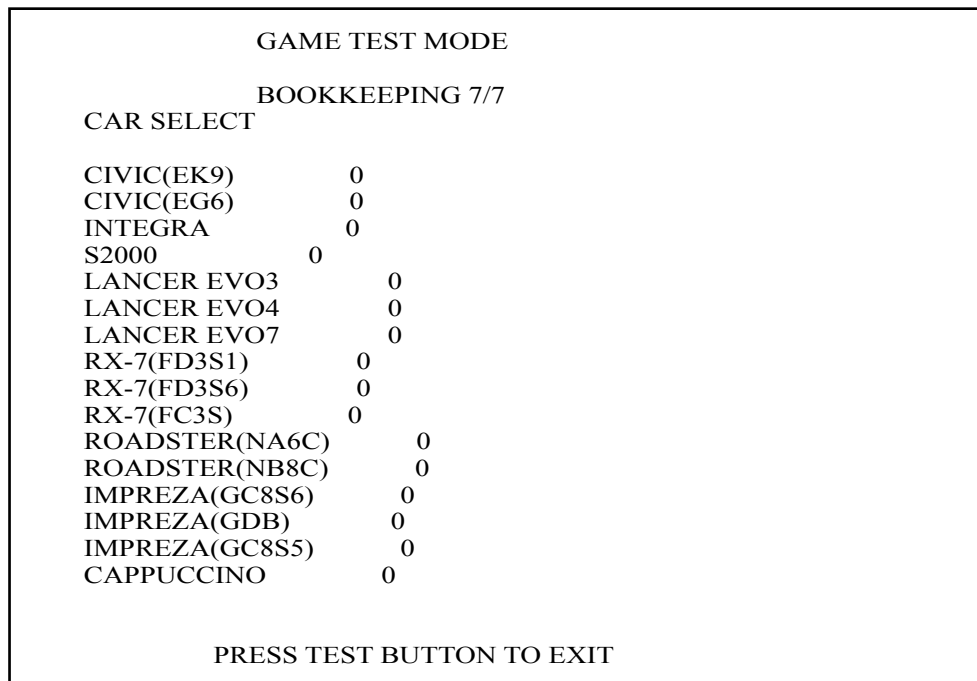

FIG. 10. 3 i BOOKKEEPING (7/7) Screen

● CAR SELECT: Displays the number of times each car was selected

Move the cursor to EXIT and press the TEST Button to return to the Game Test Menu screen.

BACKUP DATA CLEAR

Delete all BOOKKEEPING screen data. Use BACKUP DATA CLEAR in the SYSTEM TEST MODE to delete data about coin/credit collection.

Deleting this data does not affect the game settings or other data stored by the game.

Deleting this data will delete the data showing how many times the CARD R/W was used.

After deleting the data, the CARD R/W automatically enters Head Cleaning mode.

Refer to section <7-2> Head Cleaning for more information about head cleaning.

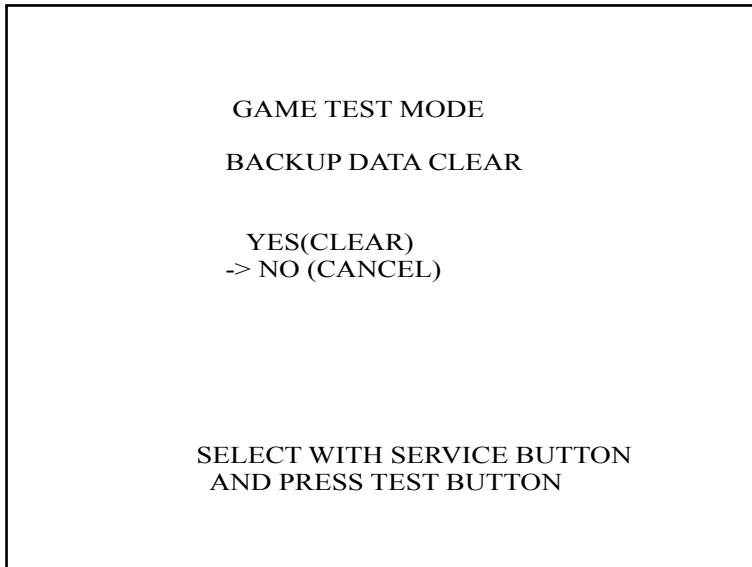

FIG. 10. 3 j BACKUP DATA CLEAR Screen

To clear data, use the SERVICE Button to move the cursor to YES (CLEAR) and then press the TEST Button. When the data has been cleared, the message "COMPLETED" will be displayed.

Press the TEST Button again to return to the Game Test Menu screen.

Move the cursor to NO (CANCEL) and press the TEST Button to return to the Game Test Menu screen without clearing the data.

Warranty

Your new Sega Product is covered for a period of 90 days from the date of shipment. This certifies that the Printed Circuit Boards, Power Supplies and Monitor are to be free of defects in workmanship or materials under normal operating conditions. This also certifies that all Interactive Control Assemblies are to be free from defects in workmanship and materials under normal operating conditions. No other product in this machine is hereby covered.

Sellers sole liability in the event a warranted part described above fails shall be, at its option, to replace or repair the defective part during the warranty period. For Warranty claims, contact your Sega Distributor.

Should the Seller determine, by inspection that the product was caused by Accident, Misuse, Neglect, Alteration, Improper Repair, Installation or Testing, the warranty offered will be null and void.

Under no circumstances is the Seller responsible for any loss of profits, loss of use, or other damages.

This shall be the exclusive written Warranty of the original purchaser expressed in lieu of all other warranties expressed or implied. Under no circumstance shall it extend beyond the period of time listed above.



SEGA ENTERPRISES, INC. (USA)

45133 Industrial Drive
Fremont, CA 94538
(415) 701-6580 phone
(415) 701-6594 fax