

KONAMI®

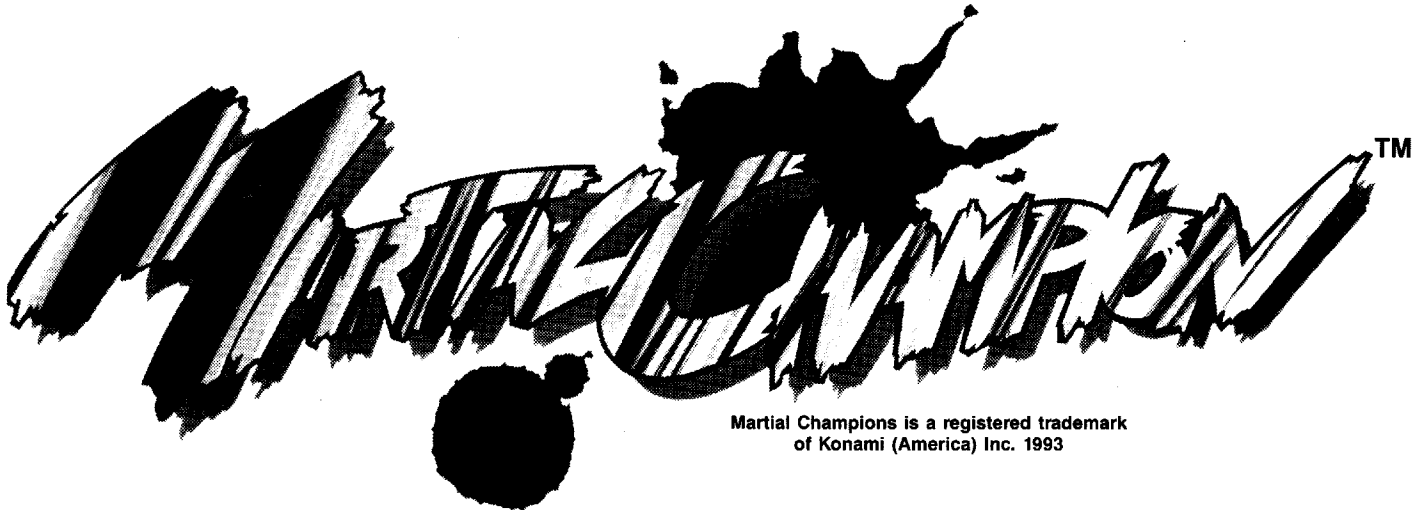

Martial Champions is a registered trademark
of Konami (America) Inc. 1993

Service & Parts #

708-215-5100

Jerry Korbecki (Service Manager) Ext. 122

George Limonez (Parts) Ext. 123

INSTRUCTION MANUAL

KONAMI® (America) Inc. is a trademark of Konami Industry Co., Ltd.

MARTIAL CHAMPION™: PARTS LIST

Part #	Description
234003	Martial Champion PCB
234100	Control Panel Overlay
234101	Player Instructions
234200	Marquee
234300	Upper Right Decal
234301	Upper Left Decal
234302	Middle Right Decal
234303	Middle Left Decal
234304	Lower Right Decal
234305	Lower Left Decal
30254	White Button
30255	Red Button
30256	Yellow Button
30258	Blue Button
30261	Microswitch
30262	Palnut
30335	Joystick
35205	ISO Transformer
35407	Power Supply
40101	Coin Door with Meter
40209	Marquee Bracket
40356	Monitor Glass
40357	Marquee Glass
40525	Monitor Glass
40611	25" Plastic Bezel

MARTIAL CHAMPION™: WIRING HARNESS

Solder Side ← → Parts Side

BLACK	GND	A	1	GND	BLACK
BLACK	GND	B	2	GND	BLACK
RED	+5V DC	C	3	+5V DC	RED
RED	+5V DC	D	4	+5V DC	RED
	NOT USED	E	5	NOT USED	
ORANGE	+12V DC	F	6	+12V DC	ORANGE
	*KEY	H	7	*KEY	
	(EMPTY)	J	8	COIN COUNTER	GREEN/GRAY
	(EMPTY)	K	9	(EMPTY)	
	(EMPTY)	L	10	(EMPTY)	
	(EMPTY)	M	11	(EMPTY)	
WHITE/GREEN	VIDEO GREEN	N	12	VIDEO RED	RED/WHITE
WHITE	VIDEO SYNC	P	13	VIDEO BLUE	BLUE/WHITE
	(EMPTY)	R	14	VIDEO GROUND	BLACK
	(EMPTY)	S	15	(EMPTY)	
VIOLET/WHITE	COIN 2	T	16	COIN 1	BLUE/BROWN
RED/GREEN	2 START	U	17	1P START	RED/YELLOW
BLUE/YELLOW	2P UP	V	18	1P UP	ORANGE/WHITE
VIOLET/YELLOW	2P DOWN	W	19	1P DOWN	BLACK/WHITE
ORANGE/GREEN	2P LEFT	X	20	1P LEFT	RED/GRAY
ORANGE/YELLOW	2P RIGHT	Y	21	1P RIGHT	GRAY/WHITE
BLACK/YELLOW	2P UPPER ATTACK	Z	22	1P UPPER ATTACK	RED/WHITE
ORANGE/GRAY	2P MIDDLE ATTACK	a	23	1P MIDDLE ATTACK	GREEN/BROWN
ORANGE	2P LOWER ATTACK	b	24	1P LOWER ATTACK	RED/BLUE
	NOT USED	c	25	NOT USED	
	NOT USED	d	26	NOT USED	
BLACK	GND	e	27	GND	BLACK
BLACK	GND	f	28	GND	BLACK

(BASE COLOR/LINE COLOR)

MARTIAL CHAMPION™: TECHNICAL INFORMATION

TECHNICAL INFORMATION

- (1) Required power capacity
GND-Vcc 5V 4A or more
GND-(+ 12V)
*See the Wiring Diagram.
- (2) Output
R (red) analog, positive
G (green) analog, positive
B (blue) analog, positive
SYNC. H-V complexed, negative
- (3) The monitor should be installed horizontally.
- (4) There is no sound volume knob on the PCB. Sound level should be adjusted in the Manual Test mode.
(See next page.)
- (5) Handle with care.

PLAY INSTRUCTIONS

- You can choose "PLAYER 1 vs COMPUTER (CPU)" or "PLAYER 1 vs PLAYER 2."
 - Buy-in available. Continue available.
 - When the player is damaged, his/her "Life" decreases. When "Life" totally runs out, the player loses a 'round.'
 - The game is of tournament style. One match consists of three rounds (90 counts per round). If the player wins two rounds in three rounds, he/she will go to the next stage (match).
 - If there is a draw round, the player will fight in an additional round. If the additional round ends up with a draw, the player loses the game (GAME OVER).
 - In the case of "PLAYER 1 vs PLAYER 2," both players can play with the same character.
- (HOW TO PLAY)
- Control your character with joystick and three buttons.
 - You can make UPPER ATTACK with the button SHOT 1, MIDDLE ATTACK with the SHOT 2 and LOWER ATTACK with the SHOT 3.
 - There are several special moves and attack for each character. These are accomplished by using different combinations of the joystick and buttons.
 - If your opponent has dropped a weapon, you can pick it up by positioning your character over it and pulling joystick down.

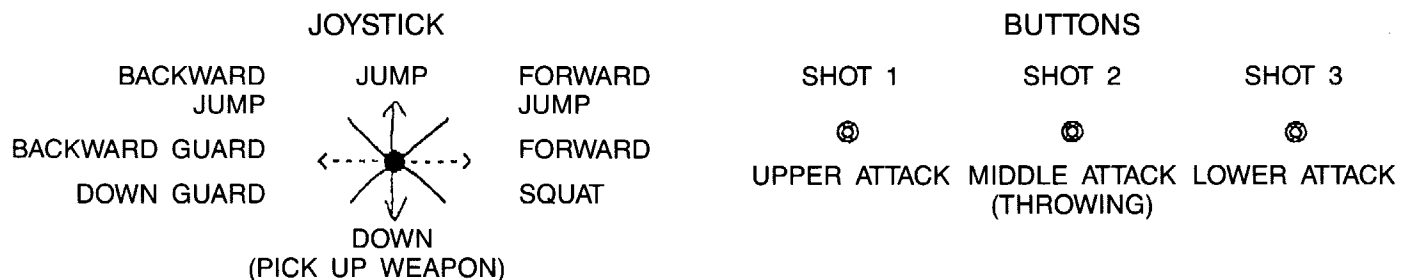

MARTIAL CHAMPION™: TECHNICAL INFORMATION (cont.)

CONTROL PANEL INFORMATION

Use a dual (for 2-player) panel with an 8-way Joystick and three function buttons for each player.

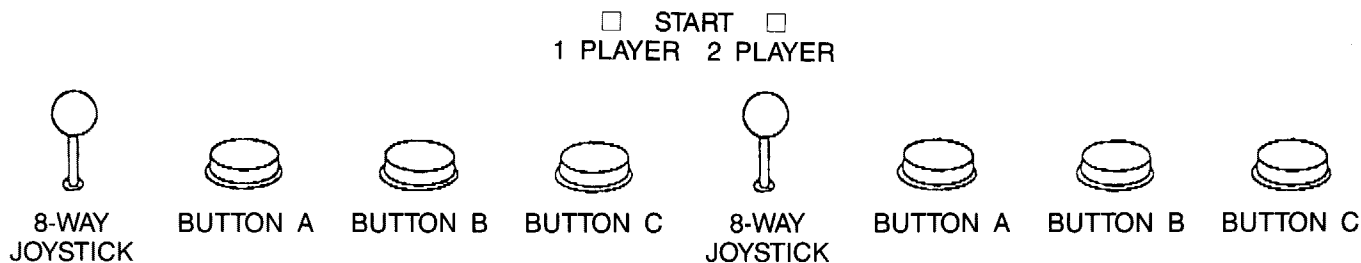

SELF TEST

Normal: "OK" will be displayed. Then the game will start.

Abnormal: "BAD" will be displayed and self test will repeat. If "15B BAD" is displayed, switch off and switch on again with TEST SWITCH (on the PCB) pressed. Switching on with TEST SWITCH pressed causes the settings of the manual test to be initialized to default.

MANUAL TEST

(1) HOW TO START

After switching on the power, press the TEST SWITCH on the PCB or on the cabinet, and you will get the MAIN MENU of the Manual Test.

NOTE: Switching on with TEST SWITCH pressed causes the program in the EEPROM to be initialized to default.

(2) HOW TO RETURN TO THE GAME MODE

Select "GAME MODE" on the MAIN MENU then press Player 1 START BUTTON to return to the game mode.

(3) ITEMS AND HOW TO SELECT

Use Player 1 JOYSTICK to select the desired test and press Player 1 START BUTTON to initiate testing. Press Player 1 START BUTTON during or at the end of each test to return to the MAIN MENU.

MAIN MENU

I/O CHECK
SCREEN CHECK
COLOR CHECK
MASK ROM CHECK
DIP SWITCH SETTINGS
SOUND OPTIONS
GAME OPTIONS
COIN OPTIONS
GAME MODE

1 PLAYER JOYSTICK = SELECT ITEM
1 PLAYER START = DO CHECK

MARTIAL CHAMPION™: TECHNICAL INFORMATION (cont.)

(4) ITEMS IN MAIN MENU

Use Player 1 Joystick to select the item and move Joystick right/left to modify setting. Factory settings are shown in green, and modified results in red. (Settings below are not always the factory settings.) After modification is completed, select "SAVE AND EXIT" and press Player 1 START button to save and return to MAIN MENU.

* If you select "EXIT" instead of "SAVE AND EXIT" after modifying some settings, the message appears: "YOU DID NOT SAVE. DO YOU WANT TO SAVE? YES/NO." When you choose "YES," the screen shows "NOW SAVINGS" and returns to MAIN MENU. If you select "NO," "NO MODIFICATION" is shown and then MAIN MENU appears.

1. I/O CHECK

Check all the joysticks and buttons to see "1" when switched on. Press Player 1 and 2 START buttons at the same time to return to MAIN MENU.

2. SCREEN CHECK

Adjust focus, alignment, size, etc. using the cross-hatch screen.

3. COLOR CHECK

Adjust color brightness so that the specified area will be colorless.

4. MASK ROM CHECK

Roms will be checked one after another, and the message "OK" or "BAD" will be displayed on the screen.

5. DIP SWITCH SETTING

You can check the settings of DIP SWITCH at this item. You can change the settings with DIP SWITCH as per the following:

DIP SW	CONTENTS	DIP SW/ON	DIP SW/OFF
SW1	SOUND OUTPUT	STEREO	MONAURAL
SW2	VIDEO SCREEN FLIP	UP SIDE DOWN	NORMAL
SW3	UNUSED		
SW4			

MARTIAL CHAMPION™: TECHNICAL INFORMATION (cont.)

6. SOUND OPTIONS

The following screen will appear:

SOUND OPTIONS

SOUND IN ATTRACT MODE
ALL THE TIME

SOUND SCALE CHECK
SOUND VOLUME = 25

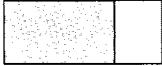

FACTORY SETTINGS
SAVE AND EXIT
EXIT

1 PLYR JOYSTICK UP/DOWN=SELECT OPTION
1 PLYR JOYSTICK RIGHT/LEFT=MODIFY SETTING

...Select out of the following 3 types for the sound for demonstration play.
... "ALL THE TIME," "ONCE EVERY 2-8 CYCLES" and "COMPLETELY OFF"

...Do, re, mi...do will sound.
...Sound volume adjustment (0-30)

...Returned to factory settings

7. GAME OPTIONS

Following screen will appear:

GAME OPTIONS

DIFFICULTY LEVEL 4/MEDIUM
VIOLENT MODE BLOODY

FACTORY SETTINGS
SAVE AND EXIT
EXIT

1 PLYR JOYSTICK UP/DOWN=SELECT OPTION
1 PLYR JOYSTICK RIGHT/LEFT=MODIFY SETTINGS

...Select out of 8 levels for play

...Difficulty level.
...With "BLOODY;" player characters spurt blood when damaged.

...Returned to Factory Settings

MARTIAL CHAMPION™: TECHNICAL INFORMATION (cont.)

8. COIN OPTIONS

Following screen will appear. The specification is for COMMON coin slot only without coin. If there are 2 COMMON coin slots, the coin option setting must be done for each coin slot.

COIN OPTIONS	
FREE PLAY	NO
COIN SLOT 1	1 COIN 1 CREDIT
COIN SLOT 2	1 COIN 1 CREDIT
PREMIUM START	NO
	1 CREDIT TO START
	1 CREDIT TO CONTINUE
FACTORY SETTINGS	
SAVE AND EXIT	
EXIT	
1 PLYR JOYSTICK UP/DOWN=SELECT OPTION	
1 PLYR JOYSTICK RIGHT/LEFT=MODIFY SETTINGS	

...Choice of Free Play (YES/NO)

} Set the number of credit per coin. (See below *COIN SETTING OPTIONS.)

... "NO" or "YES 1" to "YES 4"
(The number means the EXTRA coins necessary.)

} Set the number of credit for Start and Continue (1-8).

} Same as above "GAME OPTIONS."

*COIN SETTING OPTIONS

COIN(S)	1	1	1	1	1	1	1	2	2	2	3	3	3	4	4	4
CREDIT(S)	1	2	3	4	5	6	7	1	3	5	1	2	4	1	3	5

MARTIAL CHAMPION™: PCB LAYOUT

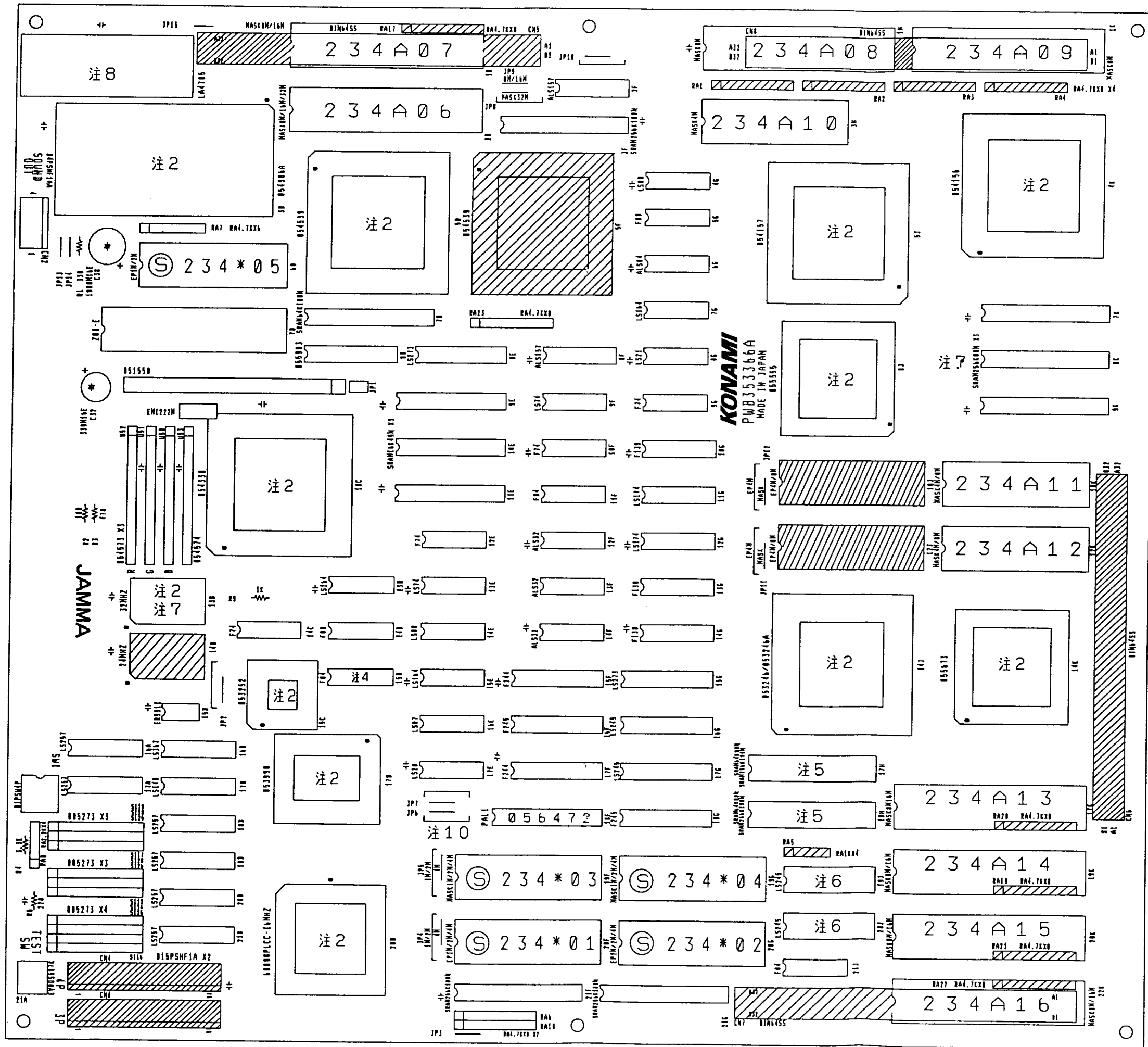

MARTIAL CHAMPION™: WIRING DIAGRAM

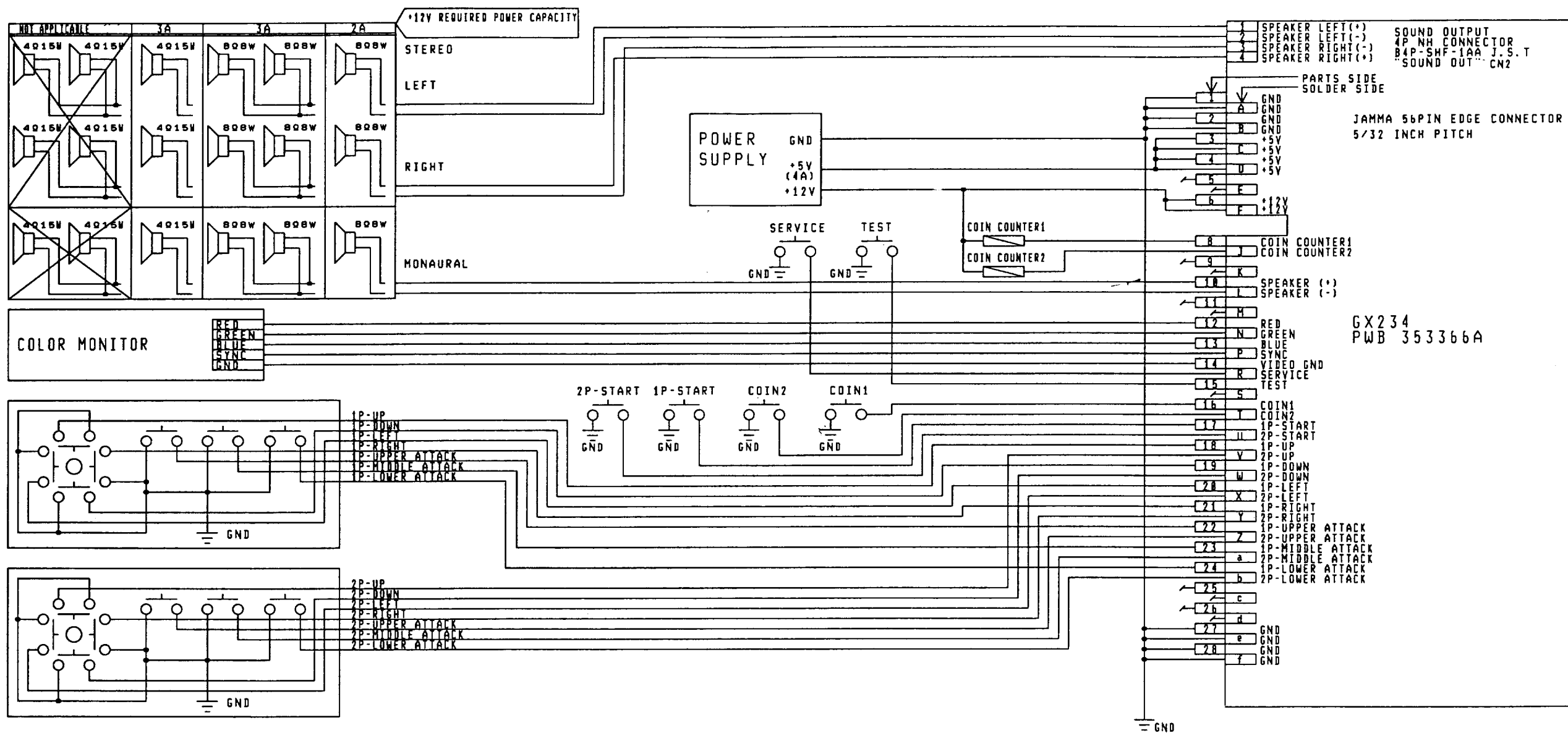

GX234
PWB 353366A

- NOTE -
- (1) 1P:NO.1 PLAYER 2P:NO.2 PLAYER
 - (2) SURGE KILLER DIODES FOR COIN COUNTER INSTALLED ON THE PCB.
 - (3) YOU CANNOT USE BOTH STEREO AND MONAURAL OUTPUTS AT THE SAME TIME.
 - (4) DO NOT CONNECT SPEAKER(-) TO GND.
SPEAKER(-)

PROPRIETARY AND CONFIDENTIAL:

REPRODUCTION FORBIDDEN WITHOUT THE SPECIFIC WRITTEN PERMISSION OF KONAMI CO.,LTD., 4-3-1, TORANOMON, MINATOKU, TOKYO 105, JAPAN. THIS DRAWING IS ONLY CONDITIONALLY ISSUED. NEITHER RECEIPT NOR POSSESSION OF THIS DRAWING OR ANY OPERATING MANUAL RELATING TO KONAMI'S GAMES OR PRODUCTS CONTAINING THIS DRAWING CONFERS OR TRANSFERS ANY RIGHT IN OR LICENSE TO USE THE PRINTED CIRCUIT BOARDS THE DRAWING OR ANY DESIGN OR TECHNICAL INFORMATION SHOWN THEREON, EXCEPT FOR MANUFACTURE BY VENDORS OF KONAMI CO.,LTD. AND FOR MANUFACTURE UNDER KONAMI'S WRITTEN LICENSE. NO RIGHT IS GRANTED TO REPRODUCE, MAKE, HAVE MADE, USE OR SELL THIS DRAWING OR THE SUBJECT MATTER THEREOF INCLUDING, WITHOUT LIMITATION, THE PRINTED CIRCUIT BOARD OR OPERATING MANUAL RELATING THERETO, WHATSOEVER, UNLESS BY WRITTEN AGREEMENT WITH OR WRITTEN PERMISSION FROM KONAMI. COPYRIGHT 1992 KONAMI CO.,LTD. ALL RIGHTS RESERVED.

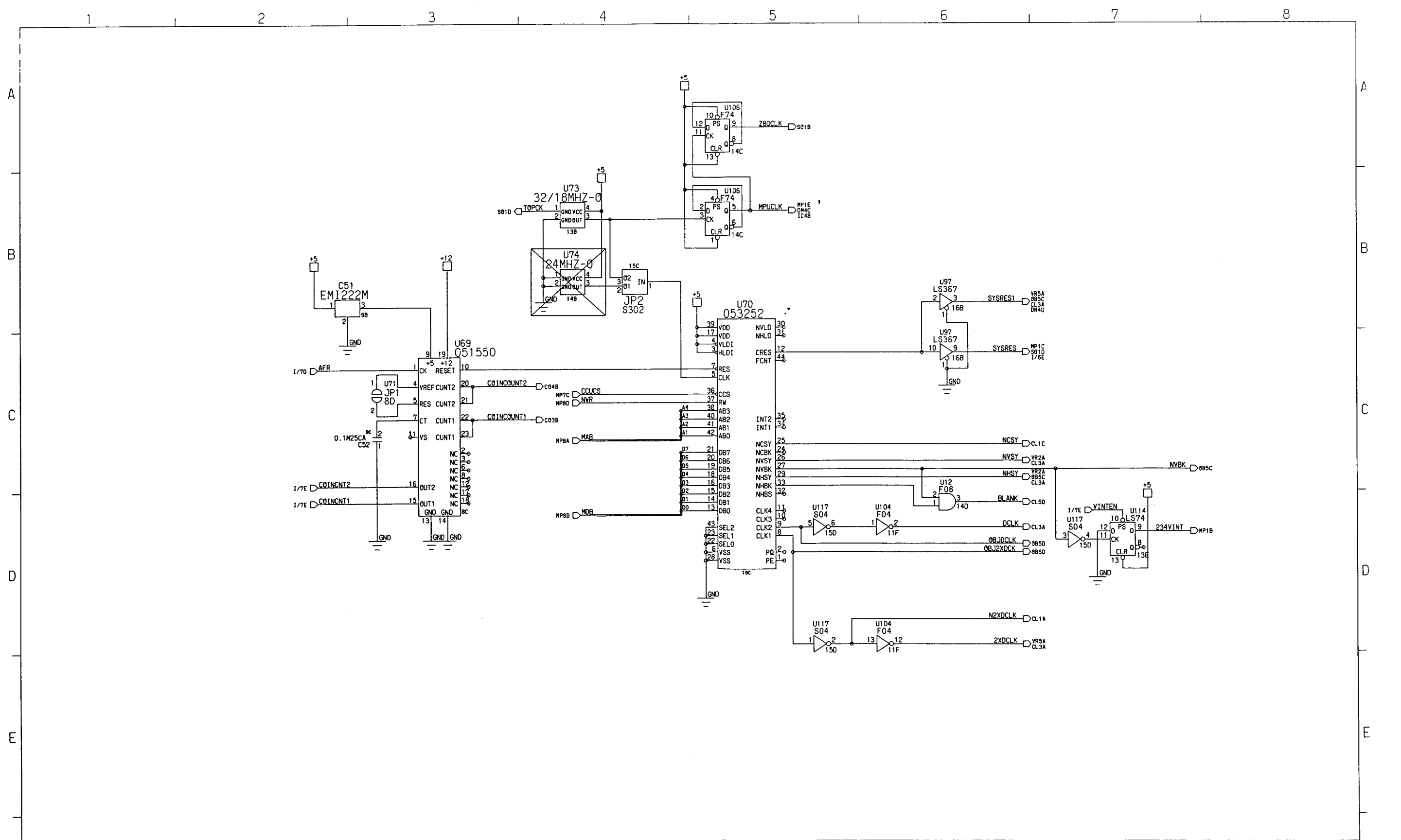

PROPRIETARY AND CONFIDENTIAL:
 REPRODUCTION FORBIDDEN WITHOUT THE SPECIFIC WRITTEN PERMISSION OF KONAMI CO.,LTD.,4-3-1.
 TORANOMON, MINATOKU, TOKYO 105, JAPAN. THIS DRAWING IS ONLY CONDITIONALLY ISSUED. NEITHER
 RECEIPT NOR POSSESSION OF THIS DRAWING OR ANY OPERATING MANUAL RELATING TO KONAMI'S GAMES OR PRODUCTS
 CONTAINING THIS DRAWING CONFERS OR TRANSFERS ANY RIGHT IN OR LICENSE TO USE THE PRINTED CIRCUIT BOARDS
 RELATING TO THIS DRAWING OR OTHER SUBJECT MATTER OF THE DRAWING OR ANY DESIGN OR TECHNICAL INFORMATION
 SHOWN THEREON, EXCEPT FOR MANUFACTURE BY VENDORS OF KONAMI CO.,LTD. AND FOR MANUFACTURE UNDER
 KONAMI'S WRITTEN LICENSE. NO RIGHT IS GRANTED TO REPRODUCE, MAKE, HAVE MADE, USE OR SELL THIS DRAWING
 OR THE SUBJECT MATTER THEREOF INCLUDING, WITHOUT LIMITATION, THE PRINTED CIRCUIT BOARD OR OPERATING
 MANUAL RELATING THERETO, WHATSOEVER, UNLESS BY WRITTEN AGREEMENT WITH OR WRITTEN PERMISSION FROM KONAMI.
 COPYRIGHT 1992 KONAMI CO.,LTD. ALL RIGHTS RESERVED.

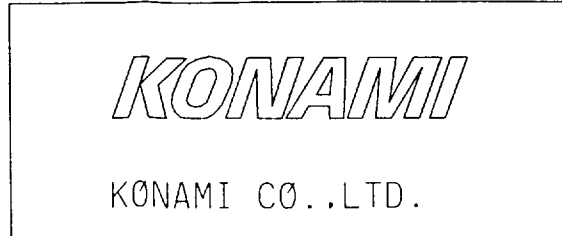

DRAWING	DESIGN	H. MURATA	TITLE	SCHEMATIC DIAGRAM
	DRAW	H. MURATA	SUBTITLE	
	CHECK	<i>[Signature]</i>	PAGE	CCU
	APPROVE	<i>[Signature]</i>	CODE NO.	353735A
	SCALE		REG. TYPE	GX234 PWB353366A
	TOLERANCE		SECURITY LEVEL	CONFIDENTIAL
	DATE	1993/02/10		

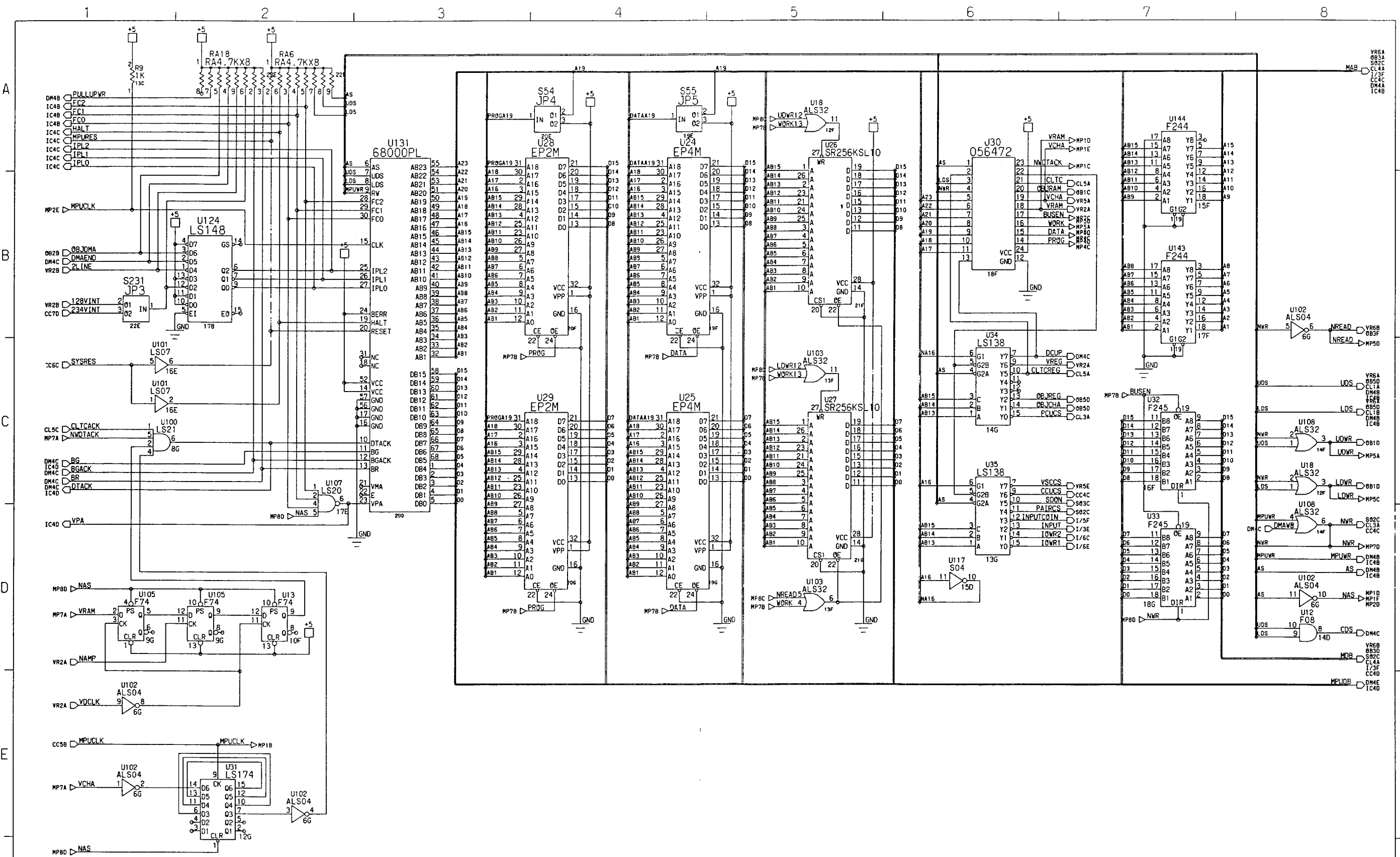

PROPRIETARY AND CONFIDENTIAL:
 REPRODUCTION FORBIDDEN WITHOUT THE SPECIFIC WRITTEN PERMISSION OF KONAMI CO., LTD. 4-3-1, TORANOMON, MINATOMU, TOKYO 105, JAPAN. THIS DRAWING IS ONLY CONDITIONALLY ISSUED. NEITHER RECEIPT NOR POSSESSION OF THIS DRAWING OR ANY OPERATING CONTAINING THIS DRAWING CONFERS OR TRANSFERS ANY RIGHT RELATING TO THIS DRAWING OR OTHER SUBJECT MATTER OF SHOWN THEREON, EXCEPT FOR MANUFACTURE BY VENDORS OF KONAMI'S WRITTEN LICENSE. NO RIGHT IS GRANTED TO OR THE SUBJECT MATTER THEREOF INCLUDING, WITHOUT LIMITATION, MANUAL RELATING THERETO, WHATSOEVER, UNLESS BY WRITTEN AGREEMENT WITH OR WRITTEN PERMISSION FROM KONAMI. COPYRIGHT 1992 KONAMI CO., LTD. ALL RIGHTS RESERVED.



DRAWING	DESIGN	H. MURATA	TITLE	SCHEMATIC DIAGRAM
	DRAW	H. MURATA	SUBTITLE	
	CHECK	<i>Y. Ashima</i>	PAGE	MPU
	APPROVE	<i>H. Murata</i>	CODE NO.	353735A
	SCALE		REG. TYPE	GX234 PWB353366A
	TOLERANCE		SECURITY LEVEL	CONFIDENTIAL
	DATE	1993/02/10		

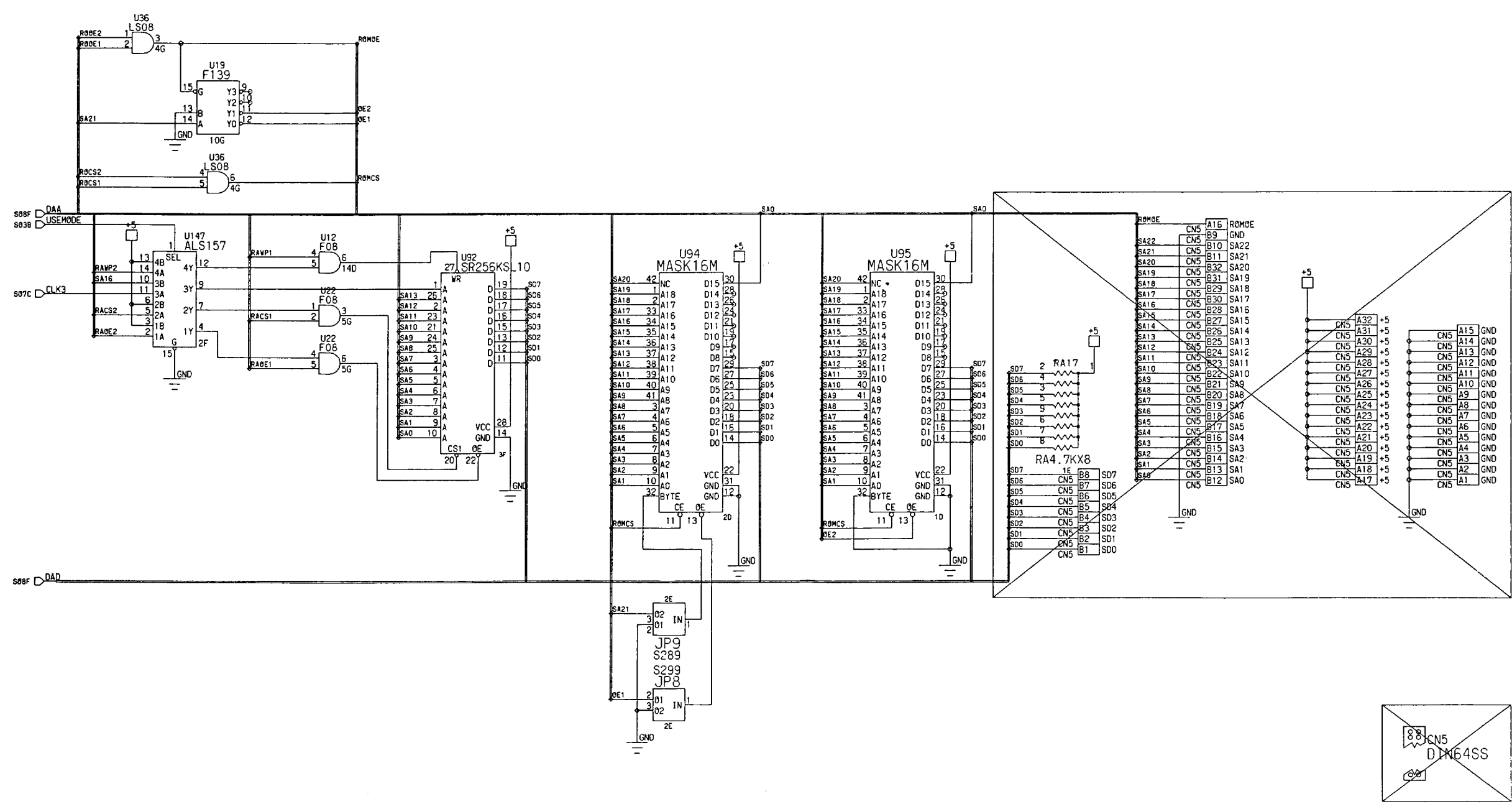

PROPRIETARY AND CONFIDENTIAL:
 REPRODUCTION FORBIDDEN WITHOUT THE SPECIFIC WRITTEN PERMISSION OF KONAMI CO., LTD., 4-3-1, TORANOMON, MINATOKU, TOKYO 105, JAPAN. THIS DRAWING IS ONLY CONDITIONALLY ISSUED. NEITHER RECEIPT NOR POSSESSION OF THIS DRAWING OR ANY OPERATING MANUAL RELATING TO KONAMI'S GAMES OR PRODUCTS CONTAINING THIS DRAWING CONFERS OR TRANSFERS ANY RIGHT IN OR LICENSE TO USE THE PRINTED CIRCUIT BOARDS RELATING TO THIS DRAWING OR OTHER SUBJECT MATTER OF KONAMI CO., LTD. AND FOR MANUFACTURE UNDER THE DRAWING OR ANY DESIGN OR TECHNICAL INFORMATION SHOWN THEREON. EXCEPT FOR MANUFACTURE BY VENDORS OF KONAMI CO., LTD. AND FOR MANUFACTURE UNDER REPRODUCE, MAKE, HAVE MADE, USE OR SELL THIS DRAWING OR THE SUBJECT MATTER THEREOF INCLUDING, WITHOUT LIMITATION, THE PRINTED CIRCUIT BOARD OR OPERATING MANUAL RELATING THERETO, WHATSOEVER, UNLESS BY WRITTEN AGREEMENT WITH OR WRITTEN PERMISSION FROM KONAMI. COPYRIGHT 1992 KONAMI CO., LTD. ALL RIGHTS RESERVED.

KONAMI
 KONAMI CO., LTD.

DRAWING	DESIGN	H. MURATA	TITLE	SCHMATIC DIAGRAM
	DRAW	H. MURATA	SUBTITLE	
	CHECK	<i>[Signature]</i>	PAGE	DAROM
	APPROVE	<i>[Signature]</i>	CODE NO.	353735A
	SCALE		REG. TYPE	GX234 PWB353366A
	TOLERANCE		SECURITY LEVEL	CONFIDENTIAL
	DATE	1993/02/10		

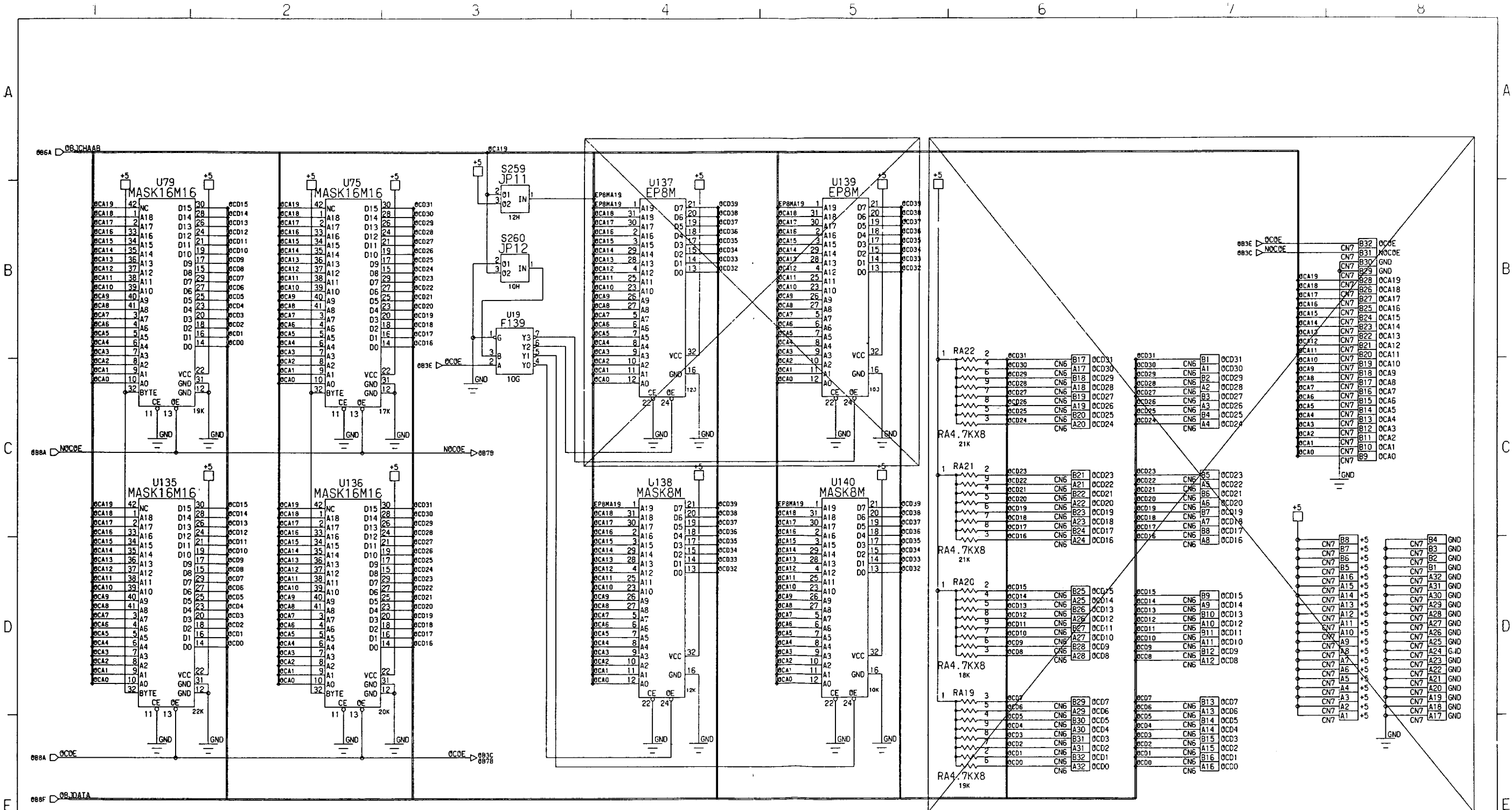

PROPRIETARY AND CONFIDENTIAL:
 REPRODUCTION FORBIDDEN WITHOUT THE SPECIFIC WRITTEN PERMISSION OF KONAMI CO., LTD. 4-3-1, TORAYDON, MINATOKU, TOKYO 105, JAPAN. THIS DRAWING IS ONLY CONDITIONALLY ISSUED. NEITHER RECEIPT NOR POSSESSION OF THIS DRAWING OR ANY OPERATING MANUAL RELATING TO KONAMI'S GAMES OR PRODUCTS CONTAINING THIS DRAWING CONFERS OR TRANSFERS ANY RIGHT RELATING TO THIS DRAWING OR OTHER SUBJECT MATTER OF SHOWN THEREON, EXCEPT FOR MANUFACTURE BY VENDORS OF KONAMI'S WRITTEN LICENSE. NO RIGHT IS GRANTED TO OR THE SUBJECT MATTER THEREOF INCLUDING, WITHOUT LIMITATION, REPRODUCE, MAKE, HAVE MADE, USE OR SELL THIS DRAWING OR THE PRINTED CIRCUIT BOARD OR OPERATING MANUAL RELATING THERETO, WHATSOEVER, UNLESS BY WRITTEN AGREEMENT WITH OR WRITTEN PERMISSION FROM KONAMI. COPYRIGHT 1992 KONAMI CO., LTD. ALL RIGHTS RESERVED.



KONAMI CO., LTD.

DRAWING	DESIGN	H. MURATA	TITLE	SCHEMATIC DIAGRAM
	DRAW	H. MURATA	SUBTITLE	
	CHECK	<i>Z. Hashimoto</i>	PAGE	0BJCHARA
	APPROVE	<i>H. Wano</i>	CODE NO.	353735A
	SCALE		REG. TYPE	GX234 PWB353366A
	TOLERANCE		SECURITY LEVEL	CONFIDENTIAL
	DATE	1993/02/10		

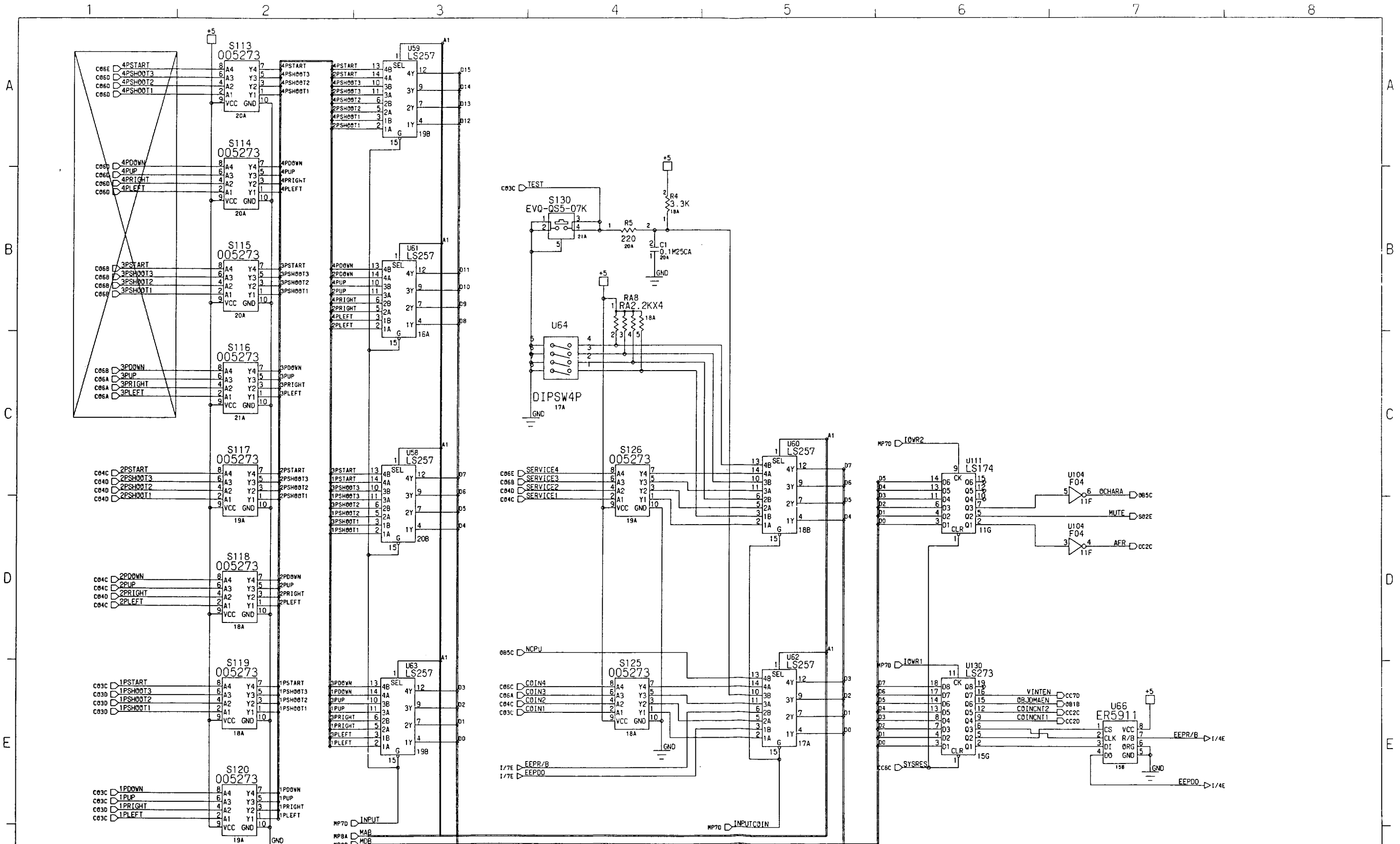

PROPRIETARY AND CONFIDENTIAL:
 REPRODUCTION FORBIDDEN WITHOUT THE SPECIFIC WRITTEN PERMISSION OF KONAMI CO., LTD. 4-3-1.
 TORANOMON, MINATOKU, TOKYO 105, JAPAN. THIS DRAWING IS ONLY CONDITIONALLY ISSUED. NEITHER
 RECEIPT NOR POSSESSION OF THIS DRAWING OR ANY OPERATING MANUAL RELATING TO KONAMI'S GAMES OR PRODUCTS
 CONTAINING THIS DRAWING CONFERS OR TRANSFERS ANY RIGHT IN OR LICENSE TO USE THE PRINTED CIRCUIT BOARDS
 RELATING TO THIS DRAWING OR OTHER SUBJECT MATTER OF THE DRAWING OR ANY DESIGN OR TECHNICAL INFORMATION
 SHOWN THEREON, EXCEPT FOR MANUFACTURE BY VENDORS OF KONAMI CO., LTD. AND FOR MANUFACTURE UNDER
 KONAMI'S WRITTEN LICENSE. NO RIGHT IS GRANTED TO REPRODUCE, MAKE, HAVE MADE, USE OR SELL THIS DRAWING
 OR THE SUBJECT MATTER THEREOF INCLUDING, WITHOUT LIMITATION, THE PRINTED CIRCUIT BOARD OR OPERATING
 MANUAL RELATING THERETO, WHATSOEVER, UNLESS BY WRITTEN AGREEMENT WITH OR WRITTEN PERMISSION FROM KONAMI.
 COPYRIGHT 1992 KONAMI CO., LTD. ALL RIGHTS RESERVED.

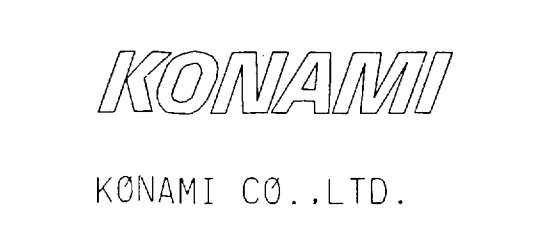

DRAWING	DESIGN	H. MURATA	TITLE	SCHEMATIC DIAGRAM
	DRAW	H. MURATA	SUBTITLE	
	CHECK	<i>Y. Ashihara</i>	PAGE	I/O
	APPROVE	<i>A. Wano</i>	CODE NO.	353735A
	SCALE		REG. TYPE	GX234 PWB353366A
	TOLERANCE		SECURITY LEVEL	CONFIDENTIAL
	DATE	1993/02/10		

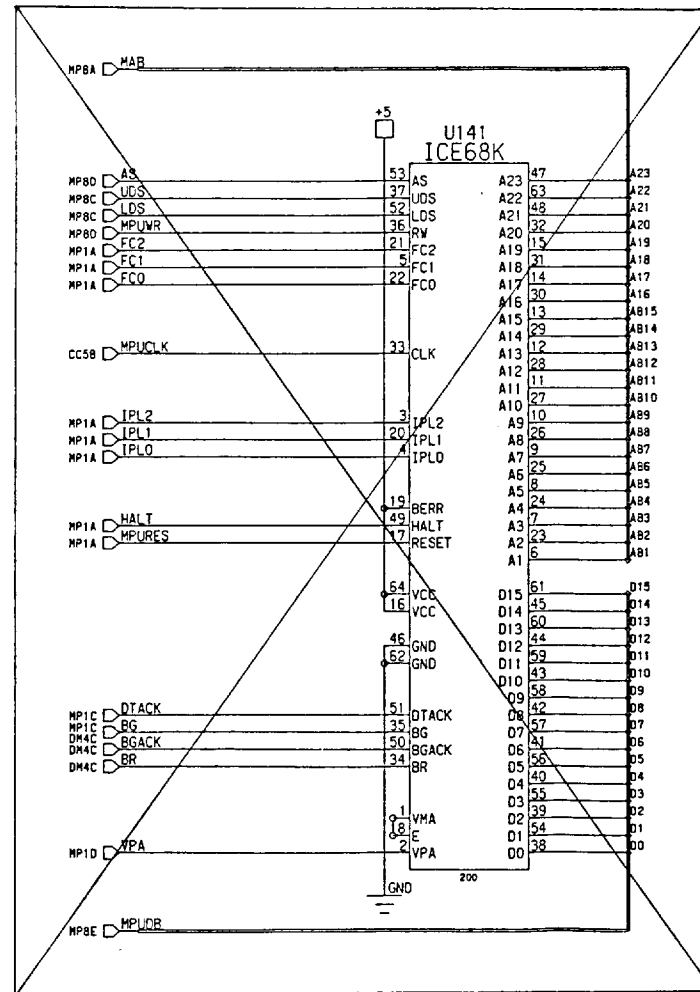

PROPRIETARY AND CONFIDENTIAL:
 REPRODUCTION FORBIDDEN WITHOUT THE SPECIFIC WRITTEN PERMISSION OF KONAMI CO., LTD., 4-3-1, TORANOMON, MINATOKU, TOKYO 105, JAPAN. THIS DRAWING IS ONLY CONDITIONALLY ISSUED. NEITHER RECEIPT NOR POSSESSION OF THIS DRAWING OR ANY OPERATING MANUAL RELATING TO KONAMI'S GAMES OR PRODUCTS CONTAINING THIS DRAWING CONFERS OR TRANSFERS ANY RIGHT IN OR LICENSE TO USE THE PRINTED CIRCUIT BOARDS RELATING TO THIS DRAWING OR OTHER SUBJECT MATTER OF THE DRAWING OR ANY DESIGN OR TECHNICAL INFORMATION SHOWN THEREON. EXCEPT FOR MANUFACTURE BY VENDORS OF KONAMI CO., LTD. AND FOR MANUFACTURE UNDER REPRODUCE, MAKE, HAVE MADE, USE OR SELL THIS DRAWING OR THE SUBJECT MATTER THEREOF INCLUDING, WITHOUT LIMITATION, THE PRINTED CIRCUIT BOARD OR OPERATING MANUAL RELATING THERETO, WHATSOEVER, UNLESS BY WRITTEN AGREEMENT WITH OR WRITTEN PERMISSION FROM KONAMI. COPYRIGHT 1992 KONAMI CO., LTD. ALL RIGHTS RESERVED.

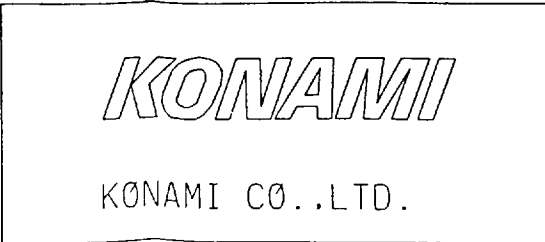

DRAWING	DESIGN	H. MURATA	TITLE	SCHEMATIC DIAGRAM
	DRAW	H. MURATA	SUBTITLE	
	CHECK	<i>[Signature]</i>	PAGE	ICE68K
	APPROVE	<i>[Signature]</i>	CODE NO.	353735A
	SCALE		REG. TYPE	GX234 PWB353366A
	TOLERANCE		SECURITY LEVEL	CONFIDENTIAL
	DATE	1993/02/10		

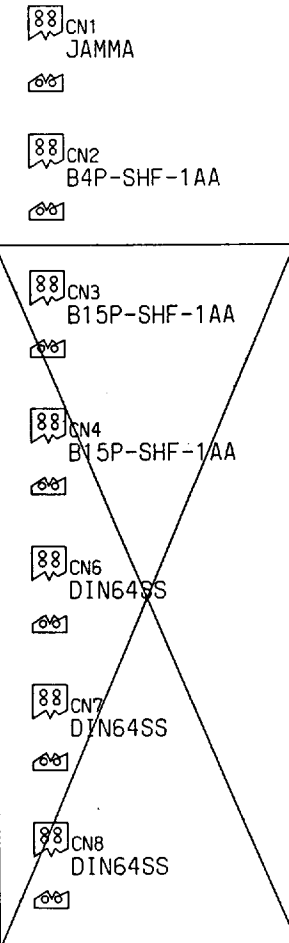
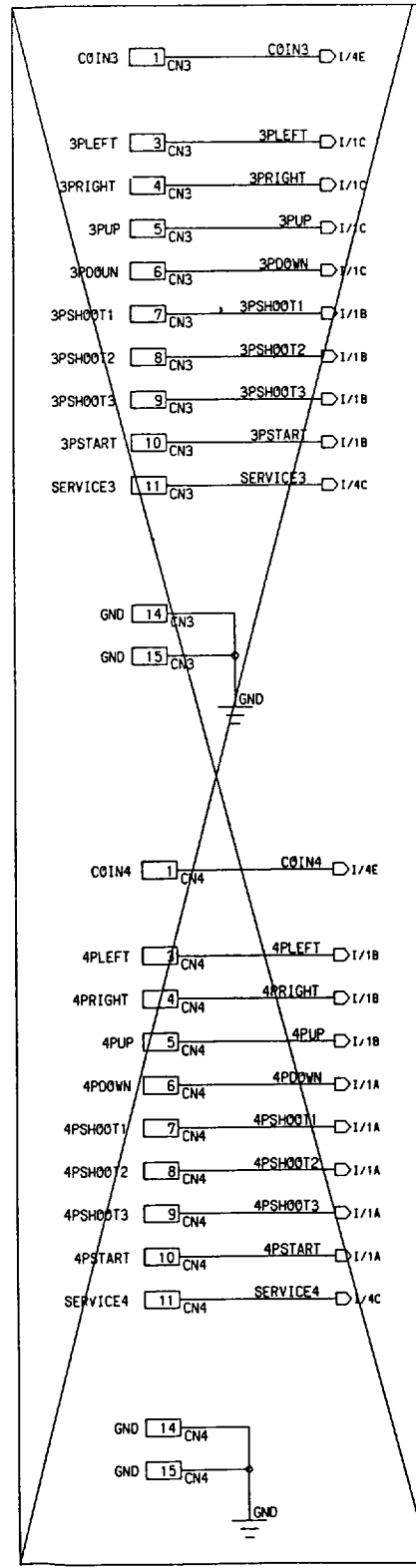
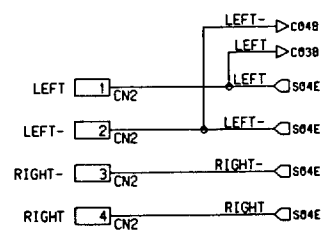
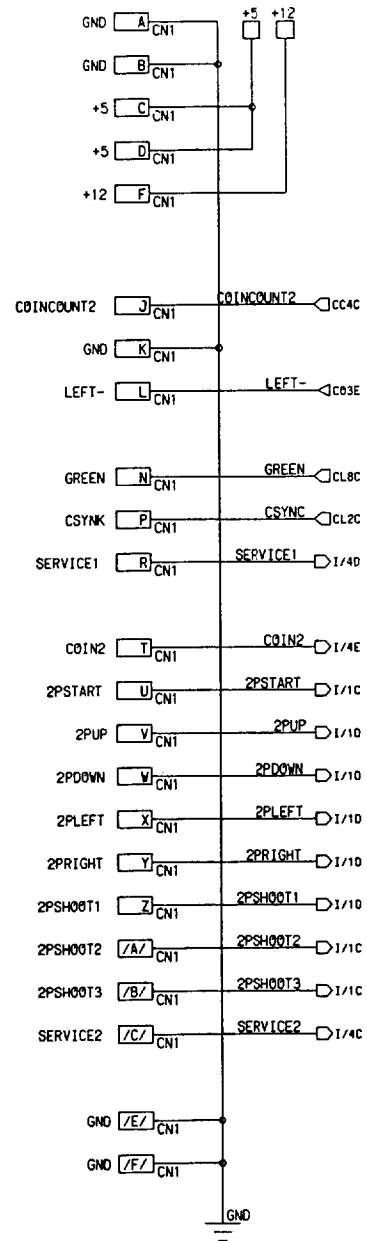
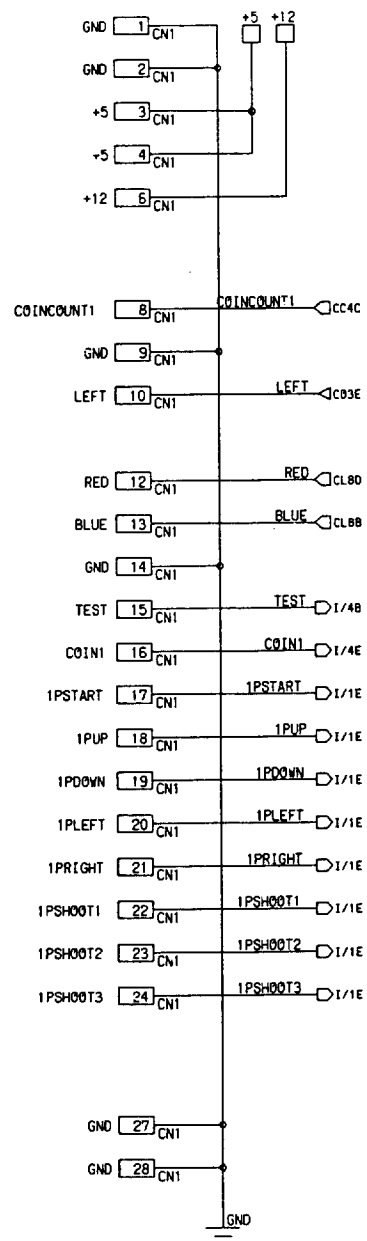

PROPRIETARY AND CONFIDENTIAL:
 REPRODUCTION FORBIDDEN WITHOUT THE SPECIFIC WRITTEN PERMISSION OF KONAMI CO., LTD., 4-3-1, TORANOMON, MINATOKU, TOKYO 105, JAPAN. THIS DRAWING IS ONLY CONDITIONALLY ISSUED. NEITHER RECEIPT NOR POSSESSION OF THIS DRAWING OR ANY OPERATING MANUAL RELATING TO KONAMI'S GAMES OR PRODUCTS CONTAINING THIS DRAWING CONFERS OR TRANSFERS ANY RIGHT IN OR LICENSE TO USE THE PRINTED CIRCUIT BOARDS RELATING TO THIS DRAWING OR OTHER SUBJECT MATTER OF THE DRAWING OR ANY DESIGN OR TECHNICAL INFORMATION SHOWN THEREON, EXCEPT FOR MANUFACTURE BY VENDORS OF KONAMI'S WRITTEN LICENSE. NO RIGHT IS GRANTED TO REPRODUCE, MAKE, HAVE MADE, USE OR SELL THIS DRAWING OR THE SUBJECT MATTER THEREOF INCLUDING, WITHOUT LIMITATION, THE PRINTED CIRCUIT BOARD OR OPERATING MANUAL RELATING THERETO, WHATSOEVER, UNLESS BY WRITTEN AGREEMENT WITH OR WRITTEN PERMISSION FROM KONAMI. COPYRIGHT 1992 KONAMI CO., LTD. ALL RIGHTS RESERVED.

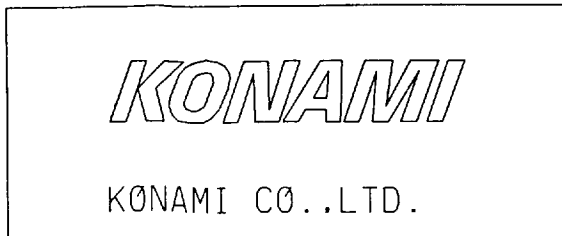

DRAWING	DESIGN	H. MURATA	TITLE	SCHEMATIC DIAGRAM
	DRAW	H. MURATA	SUBTITLE	
	CHECK	<i>[Signature]</i>	PAGE	CONNECT
	APPROVE	<i>[Signature]</i>	CODE NO.	353735A
	SCALE		REG. TYPE	GX234 PW8353366A
	TOLERANCE		SECURITY LEVEL	CONFIDENTIAL
	DATE	1993/02/10		

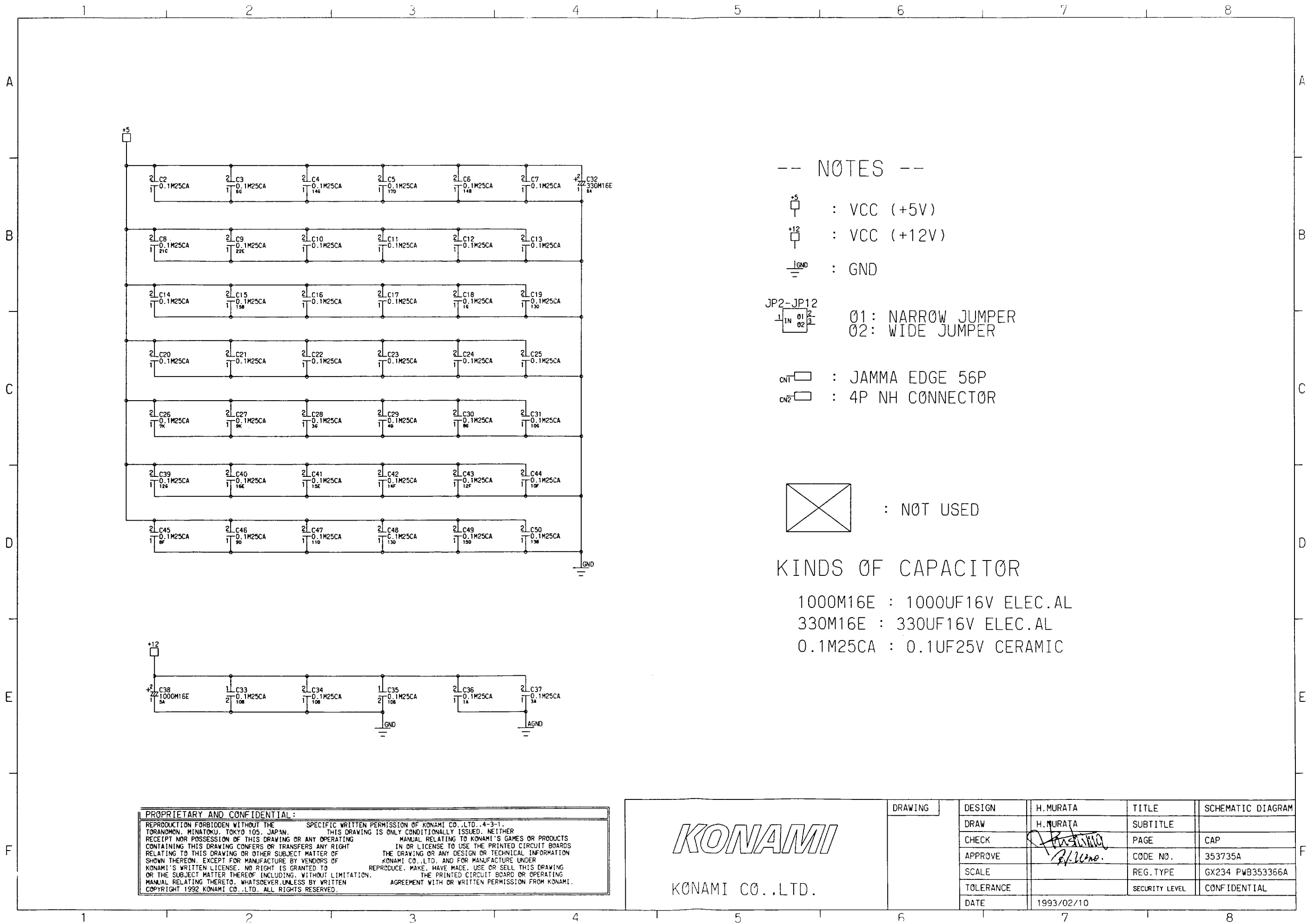

-- NOTES --

- : VCC (+5V)
- : VCC (+12V)
- : GND

JP2-JP12
 01: NARROW JUMPER
 02: WIDE JUMPER

- : JAMMA EDGE 56P
- : 4P NH CONNECTOR

: NOT USED

KINDS OF CAPACITOR

- 1000M16E : 1000UF16V ELEC.AL
- 330M16E : 330UF16V ELEC.AL
- 0.1M25CA : 0.1UF25V CERAMIC

PROPRIETARY AND CONFIDENTIAL:
 REPRODUCTION FORBIDDEN WITHOUT THE SPECIFIC WRITTEN PERMISSION OF KONAMI CO.,LTD. 4-3-1.
 TORANOMON, MINATOKU, TOKYO 105, JAPAN. THIS DRAWING IS ONLY CONDITIONALLY ISSUED, NEITHER
 RECEIPT NOR POSSESSION OF THIS DRAWING OR ANY OPERATING MANUAL RELATING TO KONAMI'S GAMES OR PRODUCTS
 CONTAINING THIS DRAWING CONFERS OR TRANSFERS ANY RIGHT IN OR LICENSE TO USE THE PRINTED CIRCUIT BOARDS
 RELATING TO THIS DRAWING OR OTHER SUBJECT MATTER OF THE DRAWING OR ANY DESIGN OR TECHNICAL INFORMATION
 SHOWN THEREON, EXCEPT FOR MANUFACTURE BY VENDORS OF KONAMI CO.,LTD. AND FOR MANUFACTURE UNDER
 KONAMI'S WRITTEN LICENSE. NO RIGHT IS GRANTED TO REPRODUCE, MAKE, HAVE MADE, USE OR SELL THIS DRAWING
 OR THE SUBJECT MATTER THEREOF INCLUDING, WITHOUT LIMITATION, THE PRINTED CIRCUIT BOARD OR OPERATING
 MANUAL RELATING THERETO, WHATSOEVER, UNLESS BY WRITTEN AGREEMENT WITH OR WRITTEN PERMISSION FROM KONAMI.
 COPYRIGHT 1992 KONAMI CO.,LTD. ALL RIGHTS RESERVED.

 KONAMI CO.,LTD.	DRAWING	DESIGN	H. MURATA	TITLE	SCHEMATIC DIAGRAM
		DRAW	H. MURATA	SUBTITLE	
		CHECK	<i>[Signature]</i>	PAGE	CAP
		APPROVE	<i>[Signature]</i>	CODE NO.	353735A
		SCALE		REG. TYPE	GX234 PWB353366A
		TOLERANCE		SECURITY LEVEL	CONFIDENTIAL
		DATE	1993/02/10		

THIS EQUIPMENT COMPLIES WITH THE REQUIREMENTS IN PART 15 OF FCC RULES FOR A CLASS A COMPUTING DEVICE. OPERATION OF THIS EQUIPMENT IN A RESIDENTIAL AREA MAY CAUSE UNACCEPTABLE INTERFERENCE TO RADIO AND TV RECEPTION REQUIRING THE OPERATOR TO TAKE WHATEVER STEPS ARE NECESSARY TO CORRECT THE INTERFERENCE. THIS DEVICE MUST ACCEPT ANY INTERFERENCE RECEIVED, INCLUDING INTERFERENCE THAT MAY CAUSE UNDESIREED OPERATION.

KONAMI®

900 Deerfield Parkway, Buffalo Grove, 60089-4510
Telephone: (708) 215-5100, Telex: 6871385 KONAM UW, Fax: (708) 215-5122