

SIDETRAK

Technical Manual

December 1979

Copyright (c) EXIDY, INC.

CONTENTS

I.	NORMAL OPERATION.....	1
	A. Attract Mode.....	1
	B. Introduction.....	2
	C. Game Play.....	2
II.	SELECTABLE OPTIONS.....	3
	A. Coinage.....	4
	B. Crashes.....	4
III.	AUDIO ADJUSTMENTS.....	5
IV.	POWER SUPPLY ADJUSTMENTS.....	6
V.	MECHANICAL ASSEMBLIES.....	7
	A. Servicing the Controls.....	7
	B. Servicing the Four-way Joy Stick.....	8
	C. Removing the Monitor.....	9
	D. Removing the Logic and Audio Boards.....	9
VI.	PARTS LIST.....	10
VII.	SCHEMATICS.....	19

I. NORMAL OPERATION

A. Attract Mode

When the game is first turned on, a five lane square track is graphically displayed. Alternating with the racetrack display is TODAY'S HIGH SCORE followed by a score which changes with each new higher score attained throughout the day. During the progress of the game, Player 1's score is displayed on the upper left of the screen, Player 2's score is displayed on the upper right of the screen, and the number of crashes left is displayed in the middle of the upper screen. When the game is turned off, the high score is reset to zero.

Also displayed on screen, at the operator's selection, will be one of the following:

PLAYER 1	PLAYER 2
----------	----------

1 COIN	1 PLAY
--------------	--------

or

1 COIN	1 PLAY
2 COIN	2 PLAY

or

2 COIN	1 PLAY
4 COIN	2 PLAY

CRASH also has a coin accumulator so a player can buy a number of games in advance.

While in the attract mode (no credits, no game in progress), the game plays automatically.

B. Introduction Mode

When a player deposits a coin, the following message comes on the screen:

SWITCH TRACKS TO AVOID
CRASH WITH KILLER ENGINE

PASS STARTING POINT FOR
BONUS CARS AND SCORE

ADDED TRAIN CARS INCREASES
SCORE

CREDITS

N

TOP THIS SCORE FOR CREDIT

M

Where N is the number of games in the credit counter, and M is a random score used by the TOP THIS SCORE feature. The TOP THIS SCORE MESSAGE appears when the option switch is set accordingly. At the operator's option, SIDETRAK awards one extra game to any player who matches or exceeds the M score.

C. Game Play

When a player presses one of the two START buttons (after coinage), a fanfare tune signals the start of play. The player's train starts at the bottom center of the screen (in the outer track) and moves counter-clockwise. The killer engine starts in the center of the screen, moving in the same direction.

The killer engine tries to crash into the player's train. The player must avoid crashes by changing tracks at interchanges. The player uses the FAST button to reach an interchange before the killer engine.

At game start, each player gets one car at the beginning of his train. When passengers are picked up by the train, a bell rings and the passengers disappear. When one car is attached to the train, the player gets 10 points for picking up passengers on the outside of the track. An additional 10 points are added each time passengers are picked up from a track closer to the center. For example, picking up passengers on the outer track, which is the fourth track from the center, 10 points are scored; 20 points are given for passengers picked up on the third track from the center; the second track from the center nets 30 points; the closest track to the center brings 40 points; and passengers picked up from the center track bring the highest score of 50 points.

Each time the player passes START on the outside track, another car is added to the train. For each car that is added, points are increased as passengers are picked up. For example, passengers picked up with a one-car train in the outermost track are worth 10 points. The same passengers picked up with two cars bring 20 points. Passengers picked up by three cars in the same outermost lane are worth 30 points, etc.

Play continues until the player crashes into the killer engine. If the player succeeds in picking up all the passengers without crashing into the killer engine, the player is rewarded with a bonus round. The bonus round resets the playing field and the player is given the same number of cars and passengers that he had at the end of play. For example, if there were three cars containing passengers at the end of the successful game, then the same three cars and passengers would appear on the field to begin the bonus round.

II. SELECTABLE OPTIONS

SIDETRAK has three switch selectable options. These are controlled by a 8-position DIP switch located on the main logic board at position 16A. This switch is accessible from the front of the game though the coin door. Figure 1 shows all selectable functions controlled by the 8-position DIP switch.

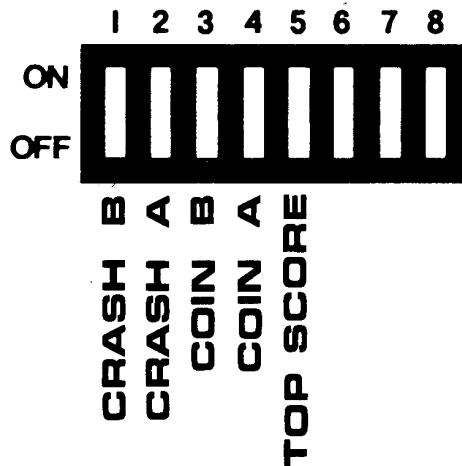

Figure 1. Functions of the 8-position DIP Switch

Following are the switch settings for the selection of options:

A. COINAGE	Switch 4	Switch 3
2 Player - 1 Coin	ON	ON
1 Player - 1 Coin	ON	OFF
2 Player - 2 Coin		
1 Player - 2 Coin	OFF	ON
2 Player - 4 Coin		
B. CRASHES (Turns)	Switch 2	Switch 1
2 Crashes	ON	ON
3 Crashes	ON	OFF
4 Crashes	OFF	ON
5 Crashes	OFF	OFF
C. TOP THIS SCORE	Switch 5	
Credit awarded for topping score	OFF	
Credit <u>not</u> awarded for topping score	ON	

III. AUDIO ADJUSTMENTS

The following is a diagram of the audio board adjustments.

SIDE TRAK AUDIO PCB. POT CONFIGURATION (ADJUSTMENTS)

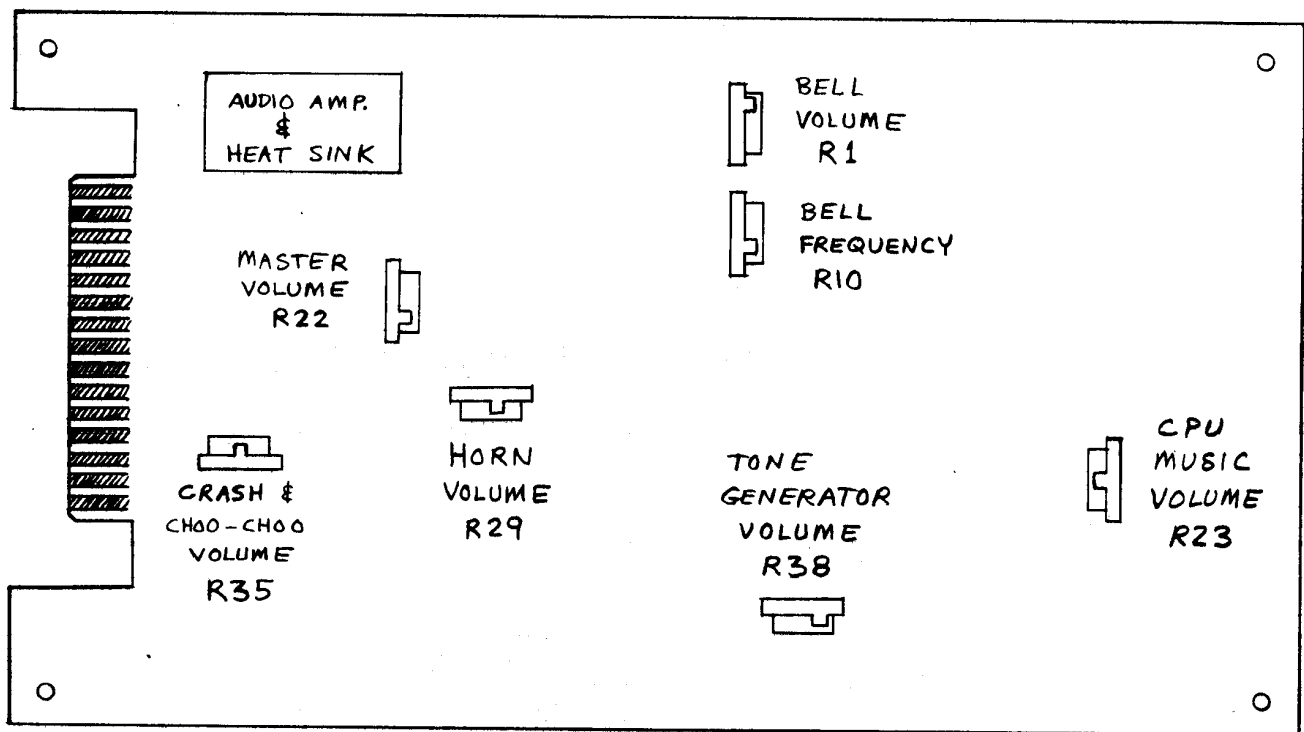

FRONT (COMPONENT) SIDE VIEW

Figure 2. Audio Board Adjustments

IV. POWER SUPPLY ADJUSTMENTS

1. Connect a voltmeter to the +5 and ground traces on the logic board.
2. Adjust the power supply potentiometer for $+5.0 \pm .1$ VDC, Figure 3.

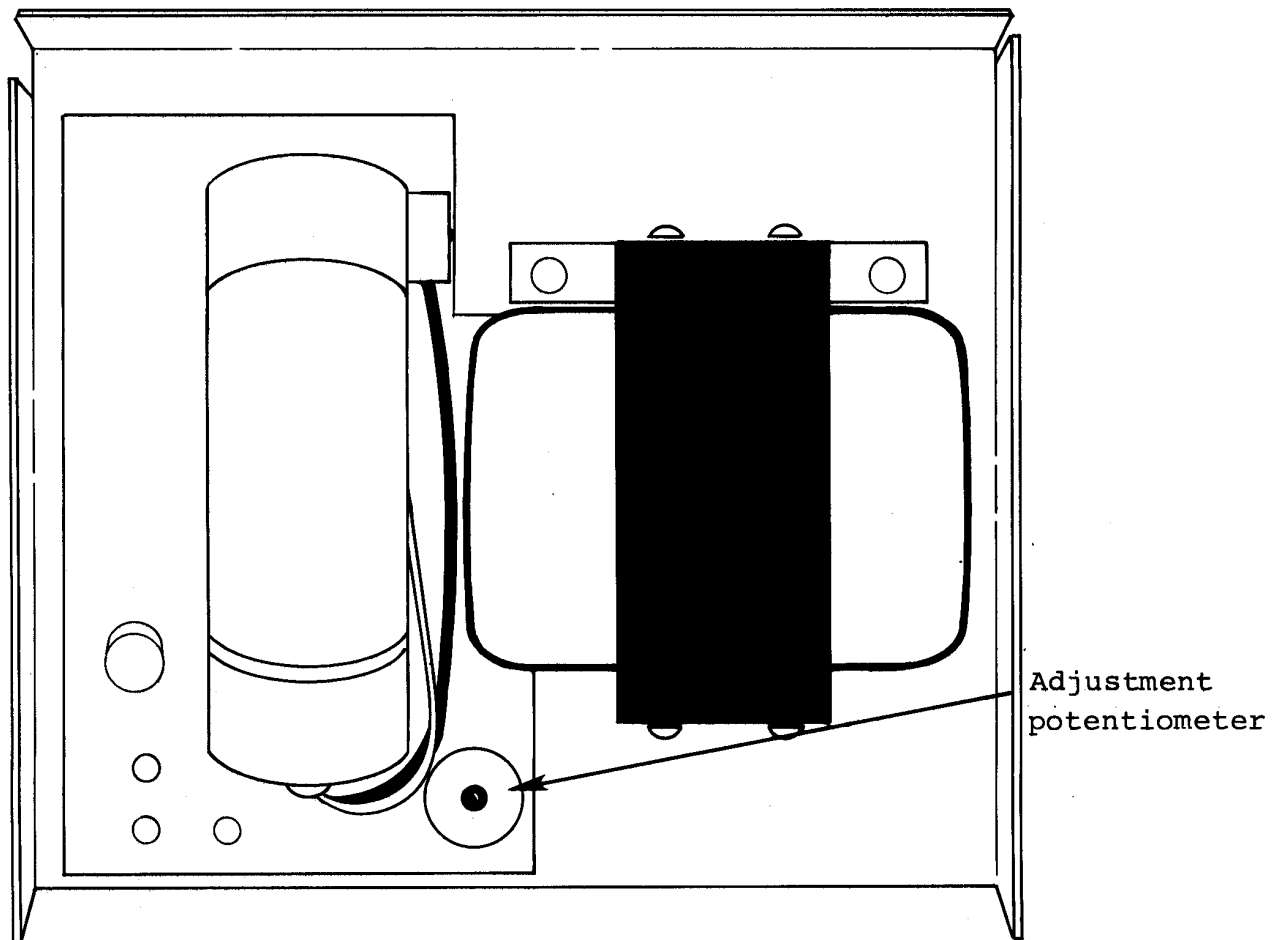

Figure 3. Power Supply Adjustment

V. MECHANICAL ASSEMBLIES

A. Servicing the Controls

Do the following to service the Controls:

1. Unplug the power cord.
2. Open and remove the back door.
3. From inside the cabinet, remove the three control panel nuts.
4. Open the coin door.
5. From the front of the cabinet, pull the control panel out and down; let it rest on the open coin door as shown in figure 4.
6. Check all terminal connections to the pushbuttons and the four-way control.

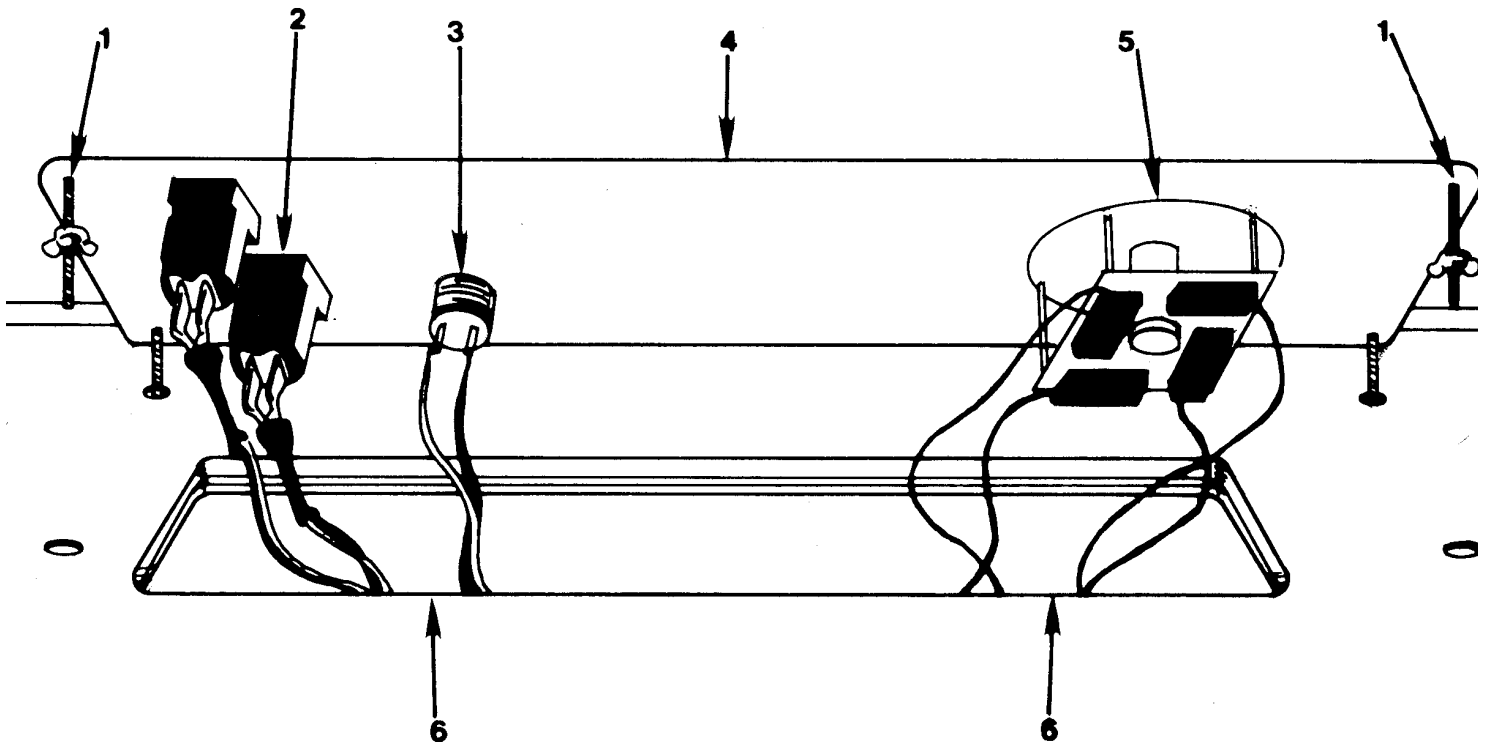

Figure 4. Control Panel

- | | |
|-----------------|--------------------|
| 1 Carriage bolt | 4 Control panel |
| 2 Start buttons | 5 Four-way control |
| 3 FAST button | 6 Control harness |

B. Servicing the Four-way Joy Stick

The four-way joy stick is mounted on the control panel with four long screws and standoff spacers. Four pairs of spring steel cup washers surround the control stick, between the control panel and the top plate (see Figure 5). These cup washers bear against a disk welded to the control stick, and push the stick towards its center (rest) position. Four leaf switches on the bottom plate (activated by the control stick) signal lane changes to the logic board.

Figure 5. Four-way Joy Stick

- | | |
|--------------------------|-------------------------------|
| 1 Carriage bolt | 8 Kep nut |
| 2 Control stick | 9 Switch plate (bottom plate) |
| 3 Control panel | 10 Kep nut (small pattern) |
| 4 Flat washer | 11 Leaf switch |
| 5 Cup washer | 12 Phillips screw |
| 6 Spacer | |
| 7 Lower disc (top plate) | |

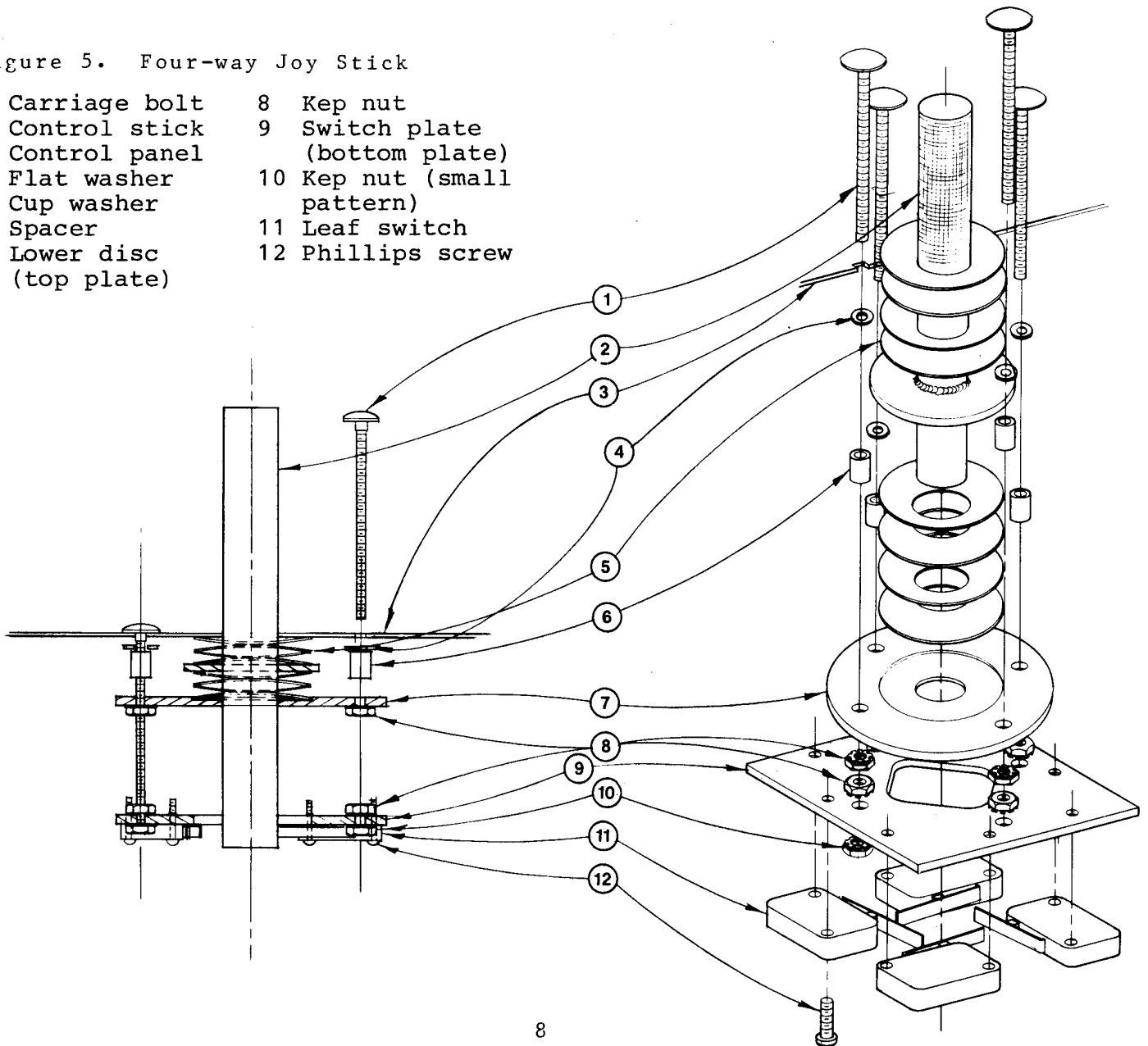

Do the following to service the Four-way Joy Stick:

1. Unplug the power cord.
2. Open the control panel.
3. Check the harness connectors to each leaf switch.
4. Check the throw of each microswitch; the control stick should activate, but not bottom-out against, each switch.
5. If necessary, adjust leaf switch throw by carefully bending the switch actuator with a long-nose pliers.

C. Removing the Monitor

To remove the monitor do the following:

1. Unplug the power cord.
2. Open and remove the back door or monitor access panel.
3. Unplug the harness connector from the monitor.
4. Remove the four bolts from the monitor chassis flange mounts.
5. Lift the monitor up and slide it out of the cabinet.

D. Removing the Logic and Audio Boards

To the following to remove the Logic and Audio Boards:

1. Unplug the power cord.
2. Open and remove the back door.
3. Disconnect the edge connector from the logic board.
4. Slide the boards out of their rack.

VI. PARTS LIST

Universal Power Supply PCB

PART #	QTY	DESCRIPTION
77-3190	1	printed circuit board
20-4000	4	4000 uf 50V axial lead cap
21-4010	2	33 uf 35V dip tantalum cap
21-4015	5	6.8 uf 35V dip tantalum cap
46-3016	2	60SI diode
47-3004	1	MDA 970-1 bridge rectifier
47-3041	1	2N3055 transistor
47-3011	1	2N6246 transistor
48-2337	1	7905T negative 5V LM320T-5 regulator
48-2217	1	7912T negative 12V LM320T-5 regulator
48-2338	1	7812T positive 12V LM340T-5 regulator
68-3041	2	thermalloy 6072 heat sink
68-2038	2	thermalloy 6015 heat sink
61-8010	1	12 pin male molex
74-2514	8	4-40 x 3/8 phillips pan head machine screw
74-5216	8	#4 flat metal washer
74-5191	8	#4-40 kep nut

Power Supply Assembly

PART #	QTY	DESCRIPTION
78-3001	1	+5VDC power supply 6 amp
63-4028	1	auxiliary transformer T911
77-3365-15	1	power supply PCB assy.
71-2389	1	power supply harness
76-1211-10	1	power supply mounting board (plywood baseplate)
74-3503	4	#6 x 1/2" L. phillips pan head self tap screw
74-5196	8	6-32 x 1/2" phillips pan head machine screw
74-3502	8	6-32 kep nut
74-3500	8	#6 American Standard plain washer

Speaker Assembly

PART #	QTY	DESCRIPTION	REFERENCE LOCATION
62-7061	1	6" x 9" oval speaker	cabinet
	2	3" brown 18 AWG insulated wire	speaker
61-8056	1	2 pin male molex connector	P14
61-8054	2	male molex pins	P14

Final Assembly

PART #	QTY	DESCRIPTION	REFERENCE LOCATION
76-1212-10	1	cabinet	
76-1212-20	1	cabinet door	
38-5054-10	1	control assy.	cabinet
38-5055-10	1	monitor assy.	cabinet
77-3361-15	1	universal game black and white logic PCB assy.	cabinet
77-3363-15	1	audio PCB assy.	logic PCB
38-5059	1	power supply assy.	cabinet
38-5057	1	make-from coin door assy.	cabinet
67-5000	1	lock and key assy.	back door
	2	coin door keys (w/Vendall coin door)	back door
	1	back door key (w/lock and key assy.)	back door
87-9003-00	1	packing list envelope (for keys)	back door
87-1062		plastic bag (for manual)	back door
35-3079	1	black paper bezel	cabinet cutout
35-3105-11	1	side artwork--left side	
35-3105-12	1	side artwork--right side	
12-3000	1	interlock switch	interior cabinet
74-0105	a/r	5/8 staples (chisel point)	harness
74-4601	6	#8 x 3/4 selftap phil. screw	PCB to cab. power to cab. monitor; spkr
74-5160	12	#10 American plain washer	
74-5165	14	1/4 I.D. x 1 1/4 D.D. fender washer	coindoor; monitor; control panel
74-6503	3	#10 external tooth lock washer	controls
74-6508	3	10/24 wing nut	controls, upper
74-6524	10	10/24 x 1 1/2 carriage bolt black full thread	speaker grill; control panel
74-7001	3	6" tie wrap	PCB; coin box lid
74-8501	3	#8 x 5/8 self tap phillips pan head	interlock, coin box
74-8502	3	#8 x 5/8 self tap phillips flat head	coinbox hasp
74-9301	4	10/32 kep nut	coin door
74-9302	15	10/24 kep nut	monitor, spkr, lower controls

Final Assembly (continued)

PART #	QTY	DESCRIPTION	REFERENCE LOCATION
74-9405	4	10/24 x 1 1/2 hex bolt	monitor
74-5148-12	1	display acrylic panel	cabinet front
68-0035-12	1	black oblong speaker grille 6" x 9"	front cabinet
68-6050-10	1	universal coin box	coinbox shelf
68-6050-20	1	universal coin box lid	coinbox shelf
68-7001	1	coinbox hasp	coinbox shelf
68-7010	1	interlock switch bracket	
83-0009	1	3 amp fuse label	inside cabinet
71-2392-10	1	main harness assy.	inside cabinet
71-2391-10	1	control harness assy.	inside cabinet
71-2390-10	1	coin harness assy.	inside cabinet
71-2389-10	1	power supply harness assy.	inside cabinet
38-5034-10	1	(make from) AC line cord harness assy.	inside cabinet

Control Panel Assembly

PART #	QTY	DESCRIPTION
68-2033-23	1	control panel
72-3022	2	push button switch
38-5068-10	1	control handle assembly
38-5044-10	1	Midway white pushbutton switch assy.
74-9411	4	10/24 x 1 1/2 carriage bolt
74-9302	4	10/24 kep nut

Monitor Assembly

PART #	QTY	DESCRIPTION
79-2304	1	19" monitor black and white w/o power supply

Universal Game Logic Black and White Assembly

PART #	QTY	DESCRIPTION	REFERENCE LOCATION
48-2000	2	IC 7400	3D, 15H
48-2005	2	IC 7402	1H, 6H
48-2010	5	IC 7404	1D, 3F, 4D, 10F, 11F
48-2015	1	IC 7407	2C

Universal Game Logic Black and White Assembly (continued)

PART #	QTY	DESCRIPTION	REFERENCE LOCATION
48-2020	1	IC 7408	5E
48-2332	1	IC 74LS11	3H
48-2035	1	IC 7420	2F
48-2316	2	IC 74LS21	12F, 15E
48-2045	1	IC 7427	7F
48-2055	1	IC 7432	6F
48-2067	2	IC 7474	1C, 5H
48-2071	2	IC 74LS112	2E, 6E
48-2307	2	IC 74LS138	5B, 5D
48-2321	2	IC 74LS139	7E, 16H
48-2090	2	IC 74157	14A, 14E
48-2095	4	IC 74161	1E, 2D, 4F, 5F
48-2100	3	IC 74166	12B, 12D, 13D
48-2115	4	IC 74193	10E, 12E, 13F, 15F
48-2328	9	IC 74LS241	1A, 3A, 3B, 4H, 6B, 7D, 9B, 9E, 15A
48-2350	4	IC 74LS245	3C, 4C, 6C, 15B
48-2314	3	IC 74LS374	1F, 14B, 7C
48-6502	1	6502 microprocessor	2A
48-2334	4	2114 (1K x 4) RAM	4A, 5A, 7B, 8B
	1	2716 EPROM (T.I.) (2K x 8)	9C
	3	2716 EPROM (T.I.) (2K x 8)	6A, 7A, 8A
	1	6341 PROM (512 x 8) (use w. hdwe. moving objects)	11D
	1	6331 PROM (32 x 8)	6C
	1	6331 PROM (32 x 8) (use w. hdwe. moving objects)	14H
	1	6301 PROM (256 x 4)	5C
46-3025	2	IN 4002 diodes	8F, 9E

1/4 w. 5% resistors:

59-5135	2	470 ohm	1D
59-5120	2	1.2K ohm	2C, 7H
59-5115	4	1.8K ohm	1C, 2C
59-5110	3	2.2K ohm	2A
59-5105	4	2.7K ohm	1C, 2C, 5H
59-5095	1	4.7K ohm	5H
59-5080	1	10K ohm	7H

1/4 w. 5% 8 pin resistors:

51-0003	1	220 ohm	9E
51-0002	1	2.2K ohm	16A
51-0001	1	4.7K ohm	15A

1/4 w. 5% 8 pin resistors: (continued)

51-0004	1	6.8K ohm	14A
23-4033	1	.01 uf ceramic capacitor	1D
23-4035	48	.1 uf ceramic capacitor	a/r
20-4011	4	6.8 uf 25 volt dip tant	1C,6E,15D,6H
20-4014	2	33 uf 25 volt dip tant	1C,2C
20-4005	1	470 uf 10 volt electrolytic	10H
72-3025	4	dip shunt jumpers 16 pin	4B,10B,10D,11B
72-3042	1	8 position dip switch	16A
45-3036	1	11.289 Mhz crystal	1D
61-8041	2	10 pin male molex	16C,16E
61-8062	5	16 pin low profile sockets	3E,4E,5C,6C, 14H
77-3361-14	1	printed circuit board	
61-8045	11	24 pin low profile sockets	5A-12A,9C,10C, 11D
61-8035	1	40 pin low profile socket	2A

Universal Make-From Coin Door Assembly

PART #	QTY	DESCRIPTION
66-4003-10	1	Vendall standard double coin door (use with all or acceptors except British and Australian)
66-4003-20	1	Vendall large (British, Australian) double coin door (use with British and Australian only)
66-4005-10	2	twenty-five-cent American Vendall coin acceptor or
66-4005-20	2	one hundred Japanese yen Vendall coin acceptor or
66-4005-30	2	one Deutschmark German Vendall coin acceptor or
66-4005-40	2	one franc French Vendall coin acceptor or
66-4005-50	2	five francs Belgian Vendall coin acceptor or
66-4005-60	2	twenty-five-cent Canadian Vendall coin acceptor or
66-4004-10	2	ten pence British Vendall coin acceptor (use with large door only) or
66-4004-20	2	twenty-cent Australian Vendall coin acceptor (use with large door only)

Audio Assembly

PART #	QTY	DESCRIPTION	REFERENCE LOCATION
48-2321	1	74LS139	1D
48-2314	2	74LS374	2C, 2D
48-2071	1	74LS112	3D
48-2308	5	74LS161	1A, 2A, 3A, 1B, 3B
48-2210	1	72748 (T.I.)	6D
48-2342	1	LM324	5B
48-2215	1	NE566	4B
48-2212	1	NE556	5A
48-2221	1	MC3340	4A
48-2211	1	LM379 (Dual 6W audio amp)	6A
48-2015	2	7407	4C, 4D
48-2302	2	74-LS04	1C, 3C
47-3005	5	2N3904	Q1-Q5
46-3030	4	1N4454	CR1-CR4
54-5021	1	100K pot	R35
54-5019	6	10K pot	R1, R10, R22, R23, R29, R38

1/4 w. resistors:

59-5070	8	22K	R6, R20, R30, R19, R31, R32, R36, R37
59-5125	4	1K	R7, R33, R40, R45
59-5163	1	820K	R41
59-5025	5	1 Meg	R9, R16, R17, R42, R47
59-5055	1	47K	R43
59-5080	5	10K	R8, R12, R36, R46, R48
59-5140	1	100 ohm	R44
59-5086	2	6.8K	R11, R134
59-5069	2	120K	R4, R24
59-5115	1	1.8K	R5
59-5050	1	68K	R3
59-5120	2	1.2K	R2, R25
59-5095	2	4.7K	R21, R49
59-5045	2	100K	R28, R15
59-5040	1	150K	R26
59-5030	1	560K	R27
59-5065	2	33K	R18, R39
59-5102	1	3.9K	R14

ceramic disk capacitors

23-4030	2	.22 uf	C41,C44
23-4035	9	.1 uf	C9,C12,C17, C31,C32,C34, C37,C42,C43
23-4070	1	22 pf	C45
23-4060	2	.001 uf	C11,C13
23-4045	2	.02 uf	C26,C28
23-4050	18	.01 uf	C1-4,C6-8,C16, C18,C23-25, C27,C29,C30, C33,C38,C39

dipped tantalum capacitors:

21-4015	8	6.8 uf	C14,C21,C22, C36,C40,C46, C47,C50
21-4020	2	2.2 uf	C48,C49
21-4010	2	33 uf 25V	C19,C20
22-4025	4	.47 uf 25V	C5,C10,C35,C15
61-8042	2	10 pin female connector	J2,J3
68-3041	1	thermalloy 6072 heat sink (for use <u>only</u> with LM379)	6A
74-2506	2	4-40 x 1/4" machine screw	6A (heat sink)
72-3025	1	DIP package shunt (16 pin) (AMP p/n 435704-8)	6B
48-9111-01	1	6331 PROM (program # STA 2B-1)	2B
74-5075	4	6-32 x 1/2" nylon standoff	between logic and audio bds.
77-3363-14A1	1	SIDE TRAK (bare) PCB	
74-3505	8	6-32 x 1/4" machine screw	in standoffs

Universal All-Postion Joystick Control

PART #	QTY	DESCRIPTION	
68-9027-10	1	upper mounting plate	
92-1013-10	1	control handle	
68-2031-10	1	lower disc	
68-2030-10	1	switch plate	
72-3023	4	microswitch	
73-9081	8	Belleville spring washer	
74-5189	8	#4-40 x 2 1/2 lg. phillips pan head screw	
74-6525	4	#10-24 x 2 1/2 lg. flat head screw	
74-6510	4	#10-3/8 lg. spacer	
74-5212	4	#10-1 1/2 lg. spacer	
74-6520	4	#10-24 kep nut (small pattern)	
74-5160	8	#10 flat washer	

Push Button Assembly

PART #	QTY	DESCRIPTION
68-0008-11	1	push button bracket
68-0008-21	1	push button bracket
72-3040	1	push button switch--white
72-3053	1	leaf switch
72-3033	1	leaf switch
72-2815	2	#2-56 UNC-2B threaded pan head screw x .25 lg.
72-2816	2	#4-40 UNC-2B threaded pan head screw x .375 lg.

AC Line Cord Harness Assembly

PART #	QTY	DESCRIPTION	REFERENCE LOCATION
71-2070	1	AC line cord	PL1
60-6020	1	fuse holder	F1
60-6001	1	fuse 3 amp slow blow	F1
61-8048	1	3 pin molex receptacle	J1
61-8055	3	individual female pins	J1
88-4002	1	small tie wrap	
61-8051	2	fast-on push on terminals .1875"	E1-E2
61-8072	1	TFB butt splice	E3

Universal Power Supply PCB

PART #	QTY	DESCRIPTION
77-3190	1	printed circuit board
20-4000	4	4000 uf 50V axial lead capacitor
21-4010	2	33 uf 35V dipped tantalum capacitor
21-4015	5	6.8 uf 35V dipped tantalum capacitor
46-3016	2	60S1 diode
47-3004	1	MDA 970-1 bridge rectifier
47-3041	1	2N3055 transistor
47-3011	1	2N6246 transistor
48-2337	1	7905T negative 5V LM320T-5 regulator
48-2217	1	7912T negative 12V LM320T-12 regulator
48-2338	1	7812T positive 12V LM340T-12 regulator
68-3041	2	thermalloy 6072 heat sink
68-2038	2	thermalloy 6015 heat sink
61-8010	1	12 pin male molex
74-2514	8	4-40 x 3/k phillips pan head machine screw
74-5216	8	#4 flat metal washer
74-5191	8	#4-40 kep nut

REVISIONS				
ZONE	LTR	DESCRIPTION	DATE	APPROVED
1			12 1 79	J. J.

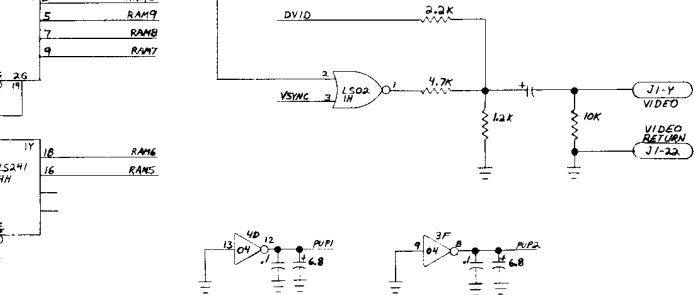
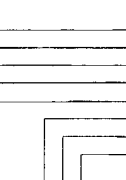
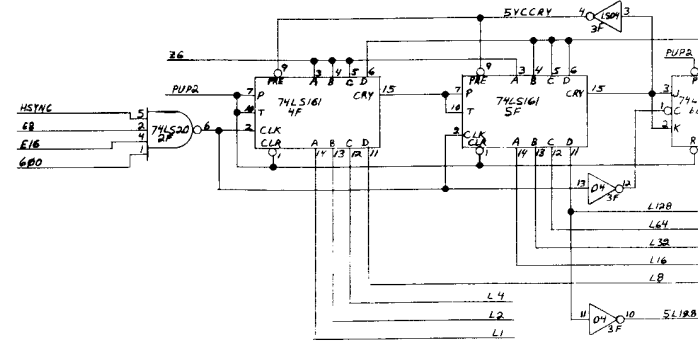
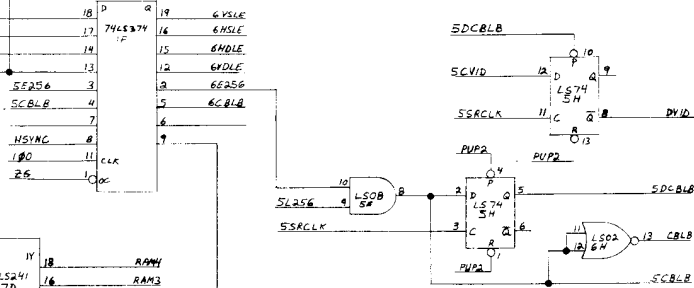
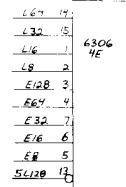
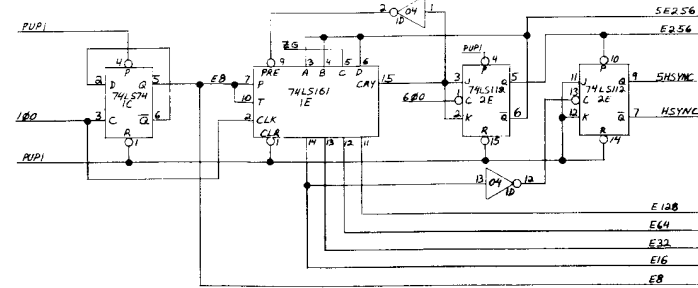
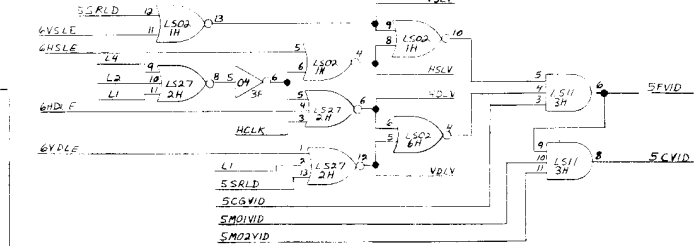
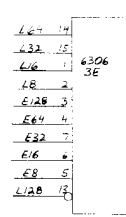
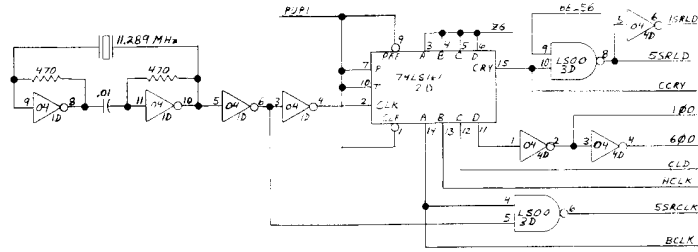

QTY REQD	CODE IDENT	PART OR IDENTIFYING NO	NOMENCLATURE OR DESCRIPTION
PARTS LIST			
UNLESS OTHERWISE SPECIFIED DIMENSIONS ARE IN INCHES TOLERANCES ARE FRACTIONS DECIMALS ANGLES .XX .XXX .XXX		CONTRACT NO	DATE
MATERIAL		APPROVALS	3/07/79
FINISH		CHECKED	3/12/79
NEXT ASSY USED ON		UNIVERSAL GAME BOARD V3.0 SYNC AND VIDEO GENERATION	
APPLICATION		DO NOT SCALE DRAWING	SCALE
SIZE		CODE IDENT NO	DRAWING NO
D			77-3361-11
SHEET		OF 8	

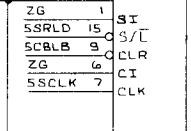
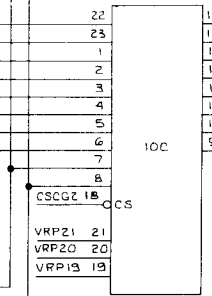
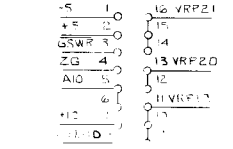
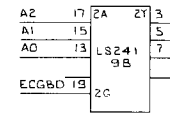
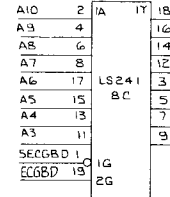
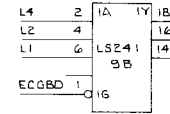
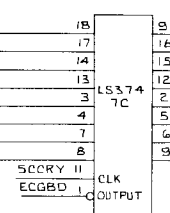
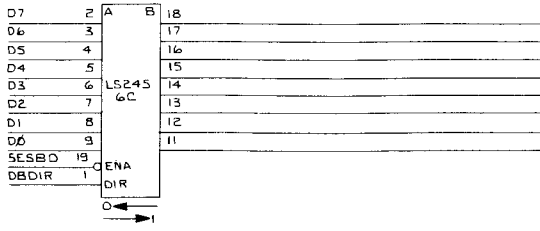
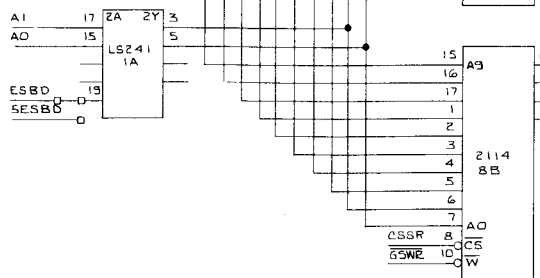
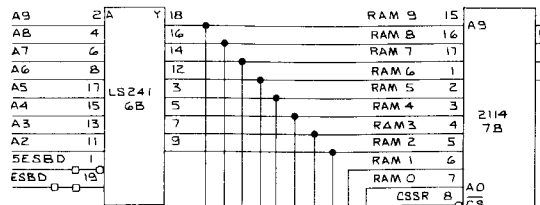
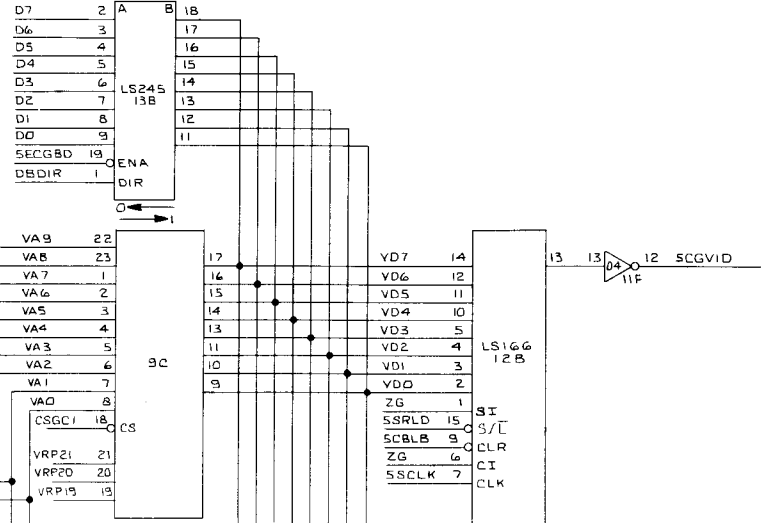
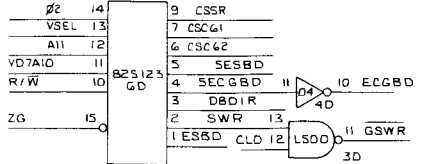

UNIVERSAL GAME BOARD V2.0		
SCALE	APPROVED	DRAWN BY
DATE: 12.5.71	<i>[Signature]</i>	REVISED
VIDEO RAM CHARACTER GENERATOR AND VIDEO REGISTERS		
DATE	DRAWING NUMBER	
12.5.71	22-336711-A	

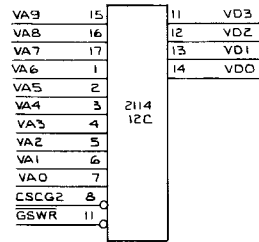
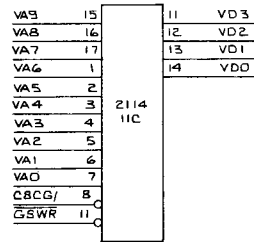
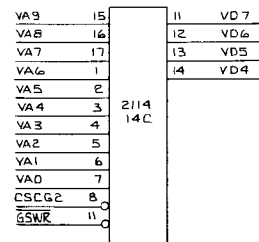
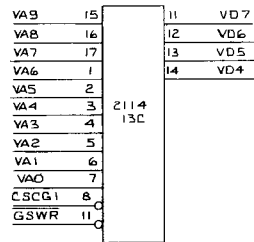

UNIVERSAL GAME BOARD V2.0		
SCALE:	APPROVED BY: <i>AKD</i>	DESIGNED BY: <i>AKD</i>
DATE: 12-4-79		REVISED:
3 OF 8		DESIGNER NUMBER: 77-3361-11

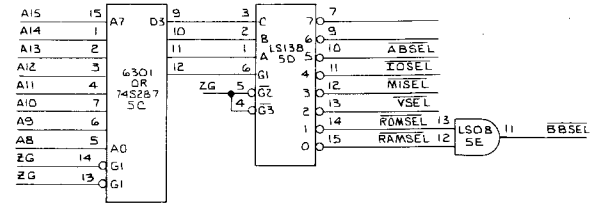
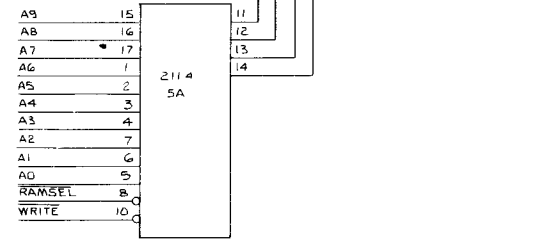
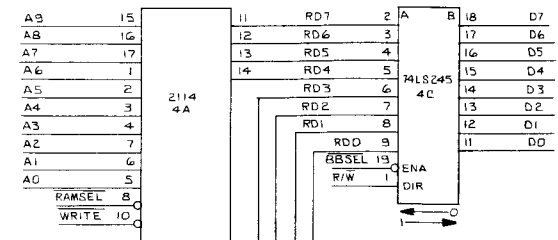
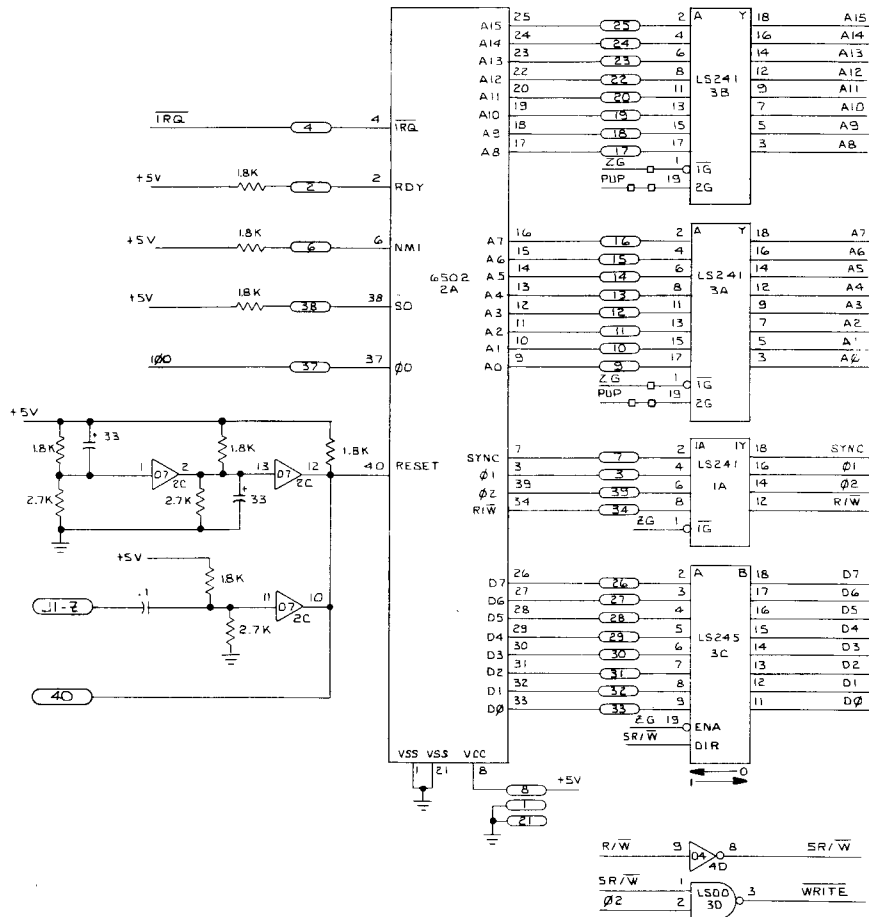

UNIVERSAL GAME BOARD V2.0			
SCALE	APPROVED BY	DRAWN BY	
DATE 12/10/79	<i>[Signature]</i>	<i>[Signature]</i>	
		REVISED	
		DRAWING NUMBER	
4 OF 8		77-3561-11-	

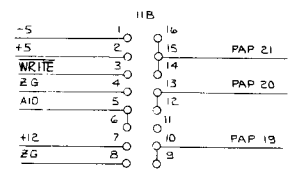
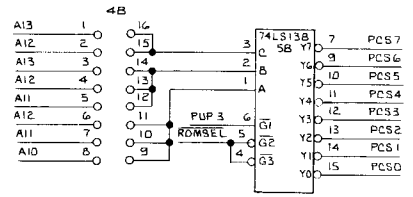
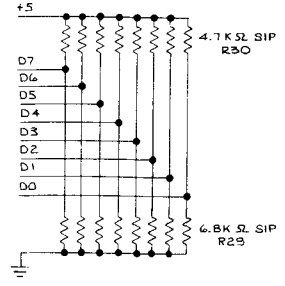
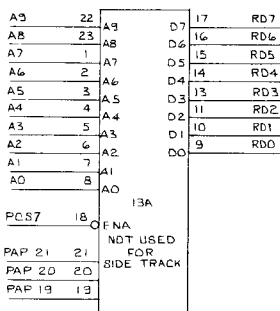
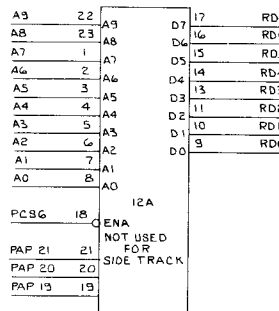
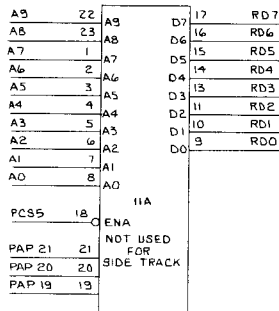
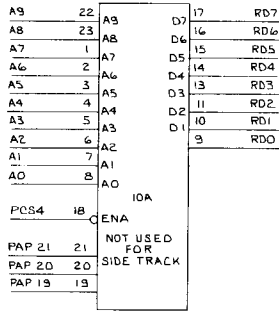
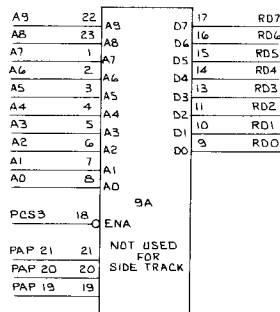
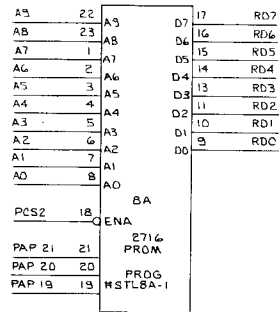
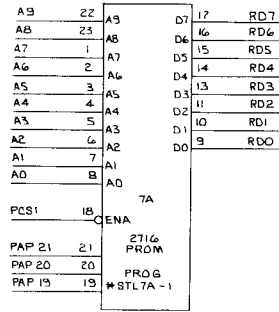
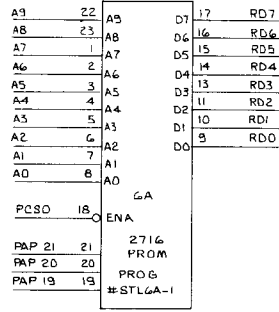

EXIDY INC.		
SCALE	APPROVED BY <i>[Signature]</i>	DRAWN BY <i>[Signature]</i>
DATE 12-14-79	REVISED	
UNIVERSAL GAME BOARD V2.0		
CPU ROM		
5 OF 8		DRAWING NUMBER 77-3361-11-A2

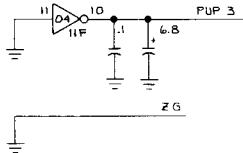
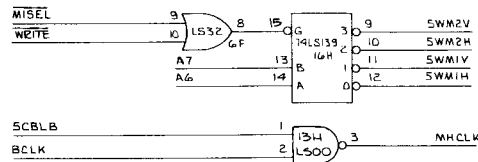
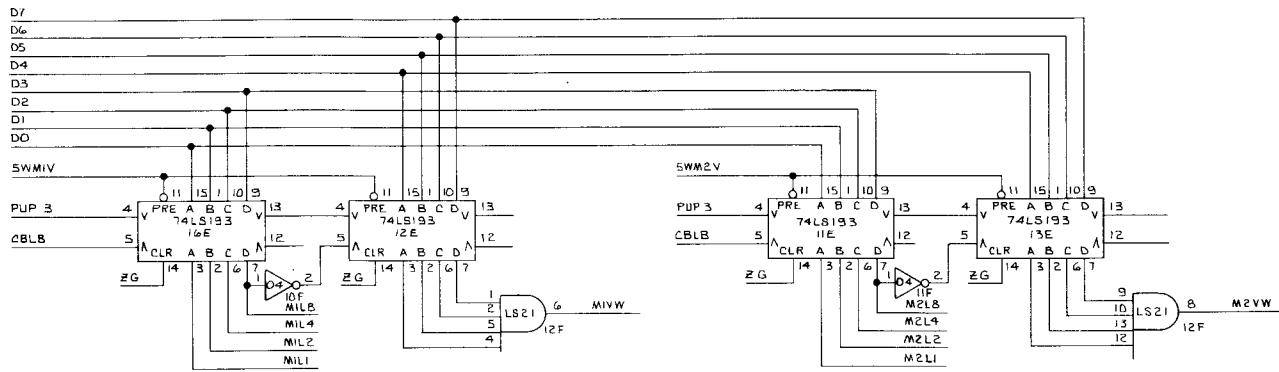
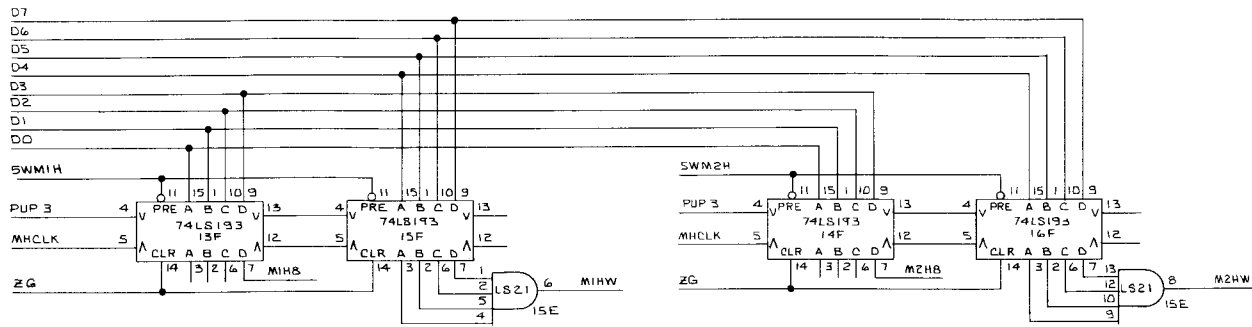

SCALE:	APPROVED BY:	DESIGNED BY:
DATE: 12-20-78	<i>CRH</i>	REVIEWED:
UNIVERSAL GAME BOARD V2.0		
MOVING OBJECT POSITION COUNTERS		
6 OF 8	DESIGNED NUMBER:	77-3364-11A

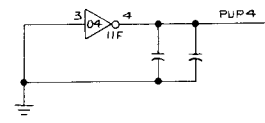
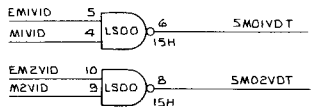
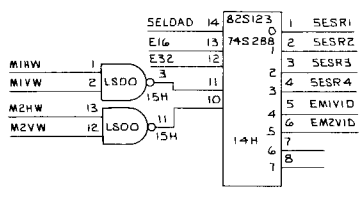
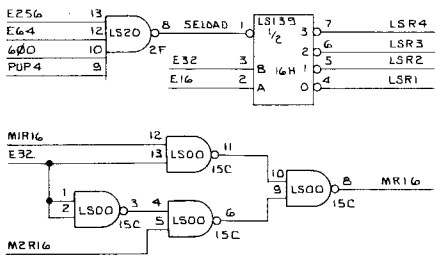
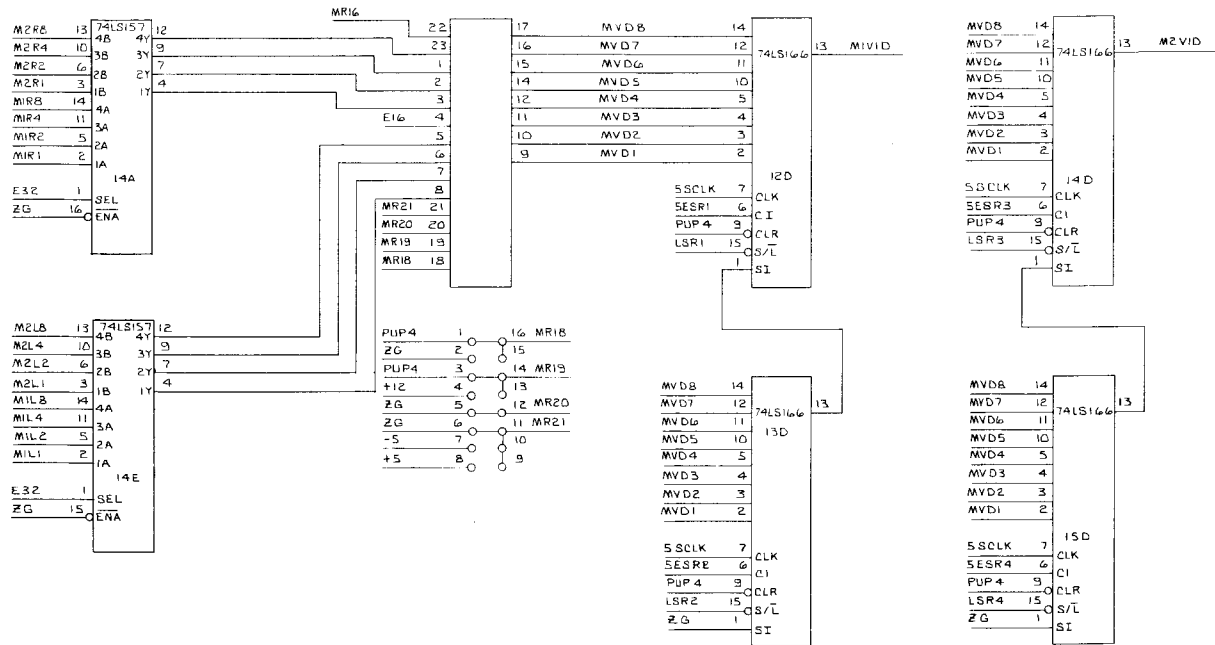

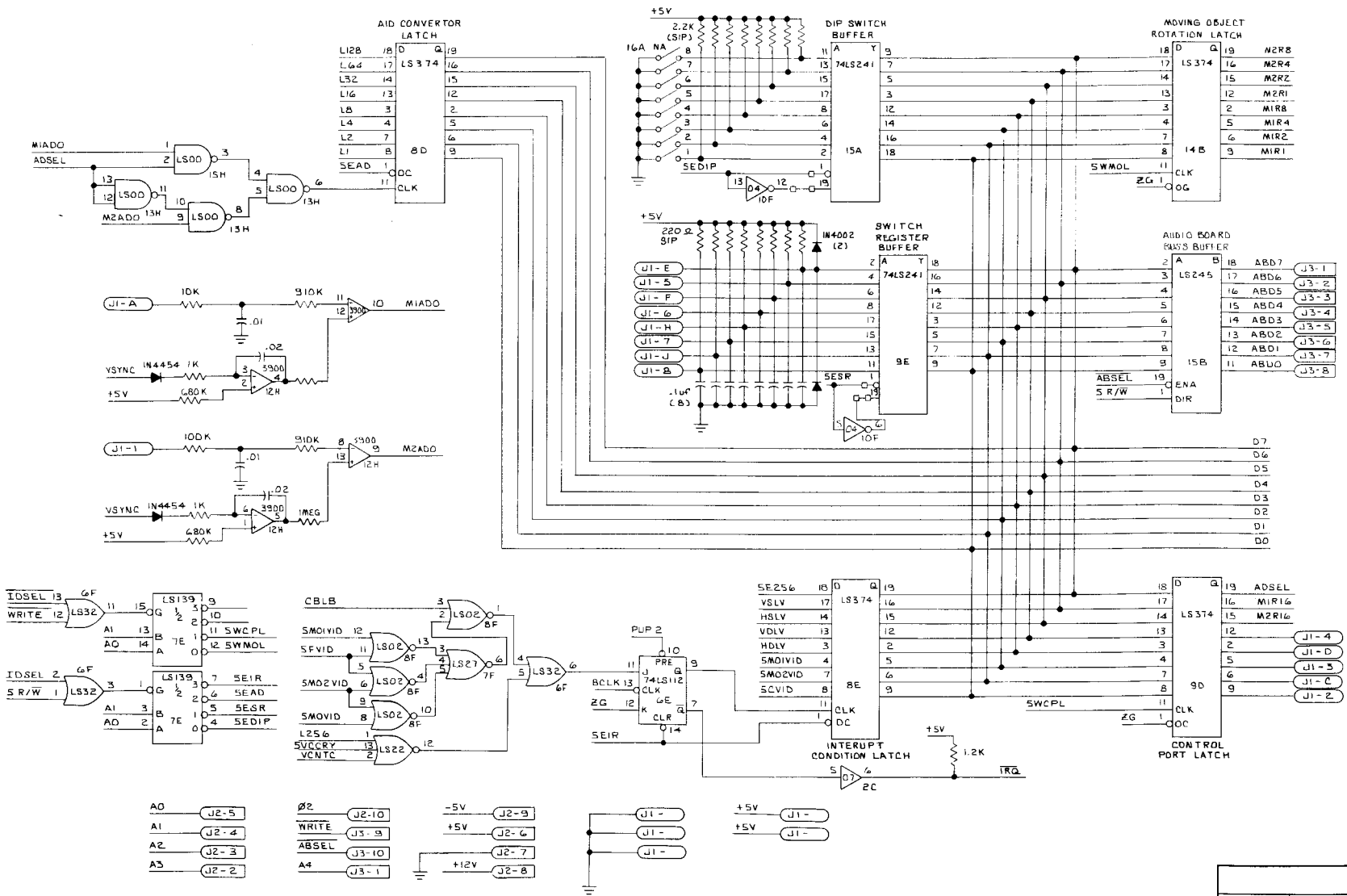

SCALE:	APPROVED BY:	DESIGNED BY:
DATE: 12-18-79	<i>OKH</i>	REVISED:
UNIVERSAL GAME BOARD V2.0 I/O PORT		
REF 8		71-3361-11-A

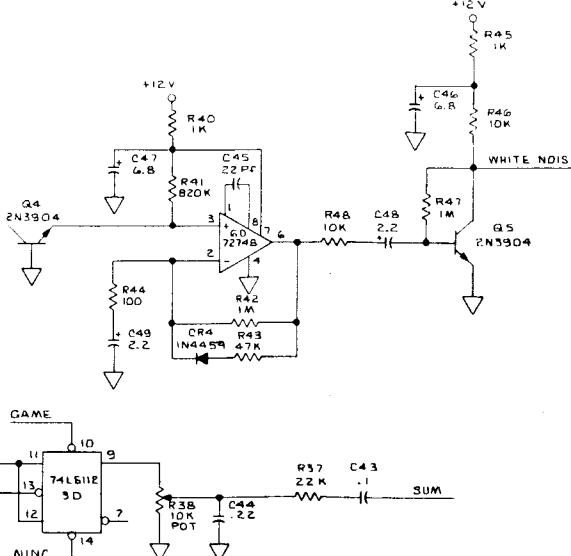
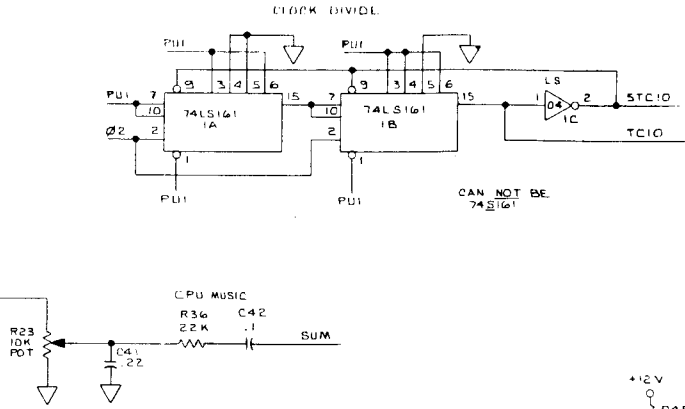
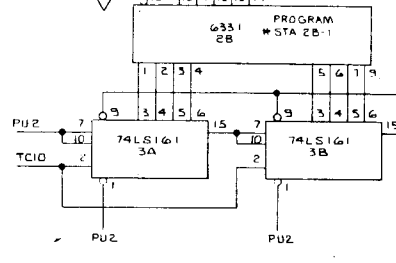
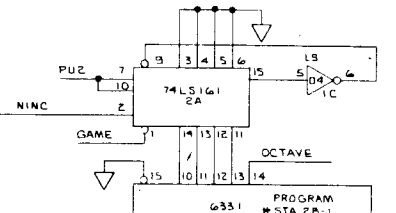
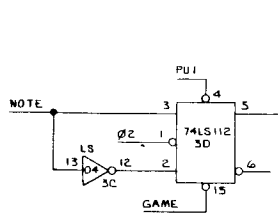
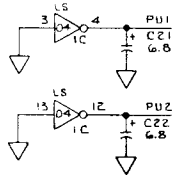
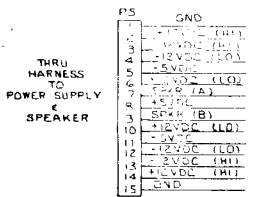
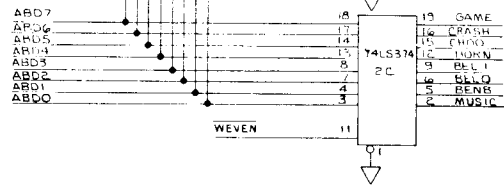
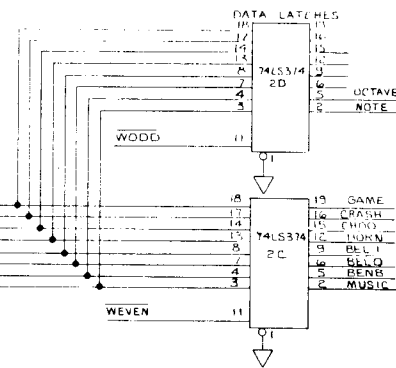
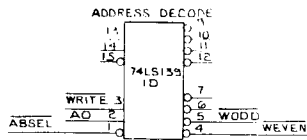
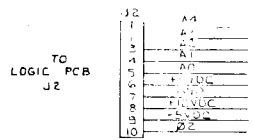

EXIDY INC.		
DATE: 11/11/79	APPROVED BY: <i>CR</i>	DESIGNED BY: <i>CR</i>
SIDE TRACK AUDIO		
1 OF 2	REVISION NUMBER: 77-3363-11-A2	

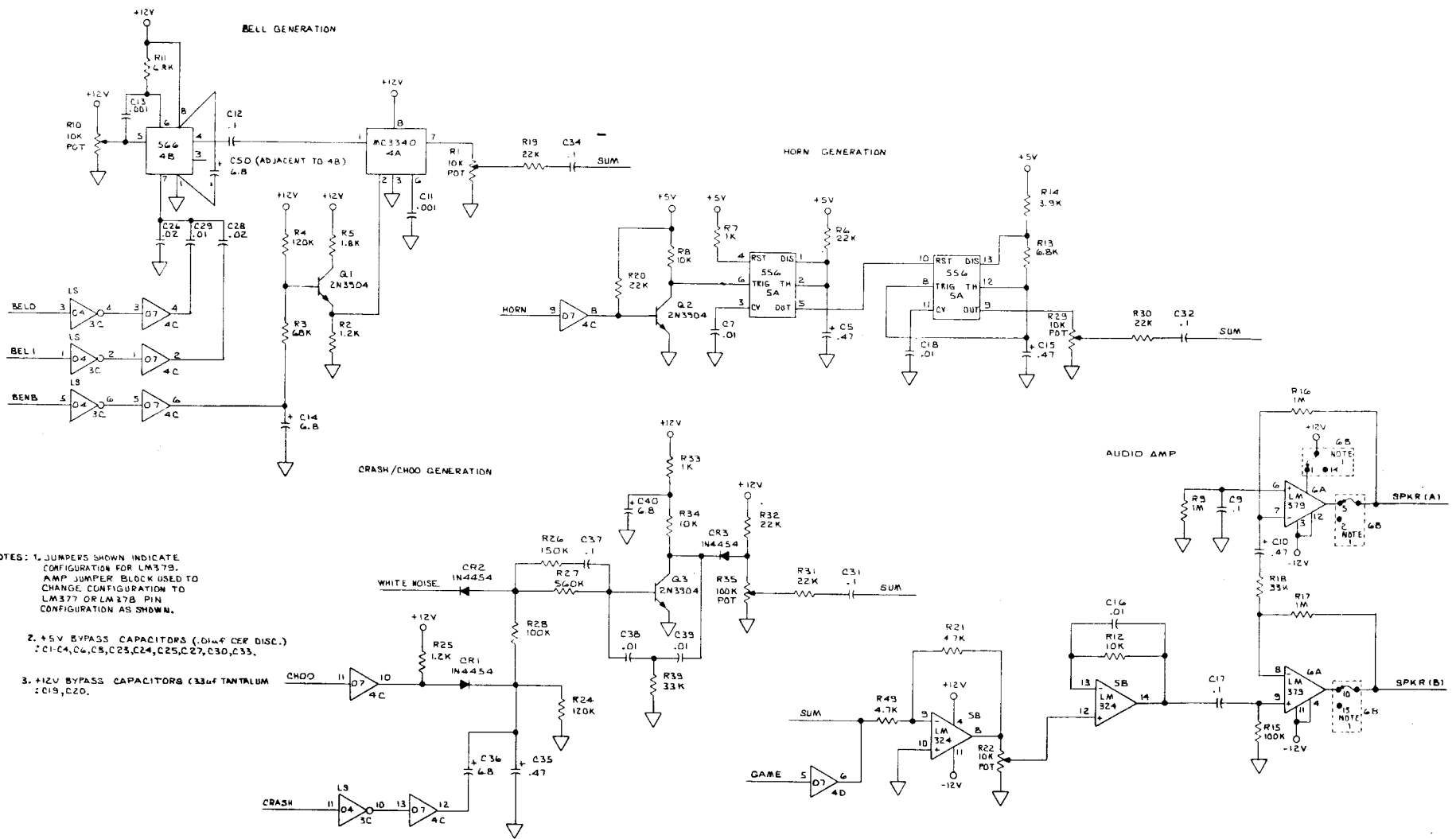

SIDE TRAK MAIN HARNESS SCHEMATIC (UNIVERSAL MAIN HARNESS)

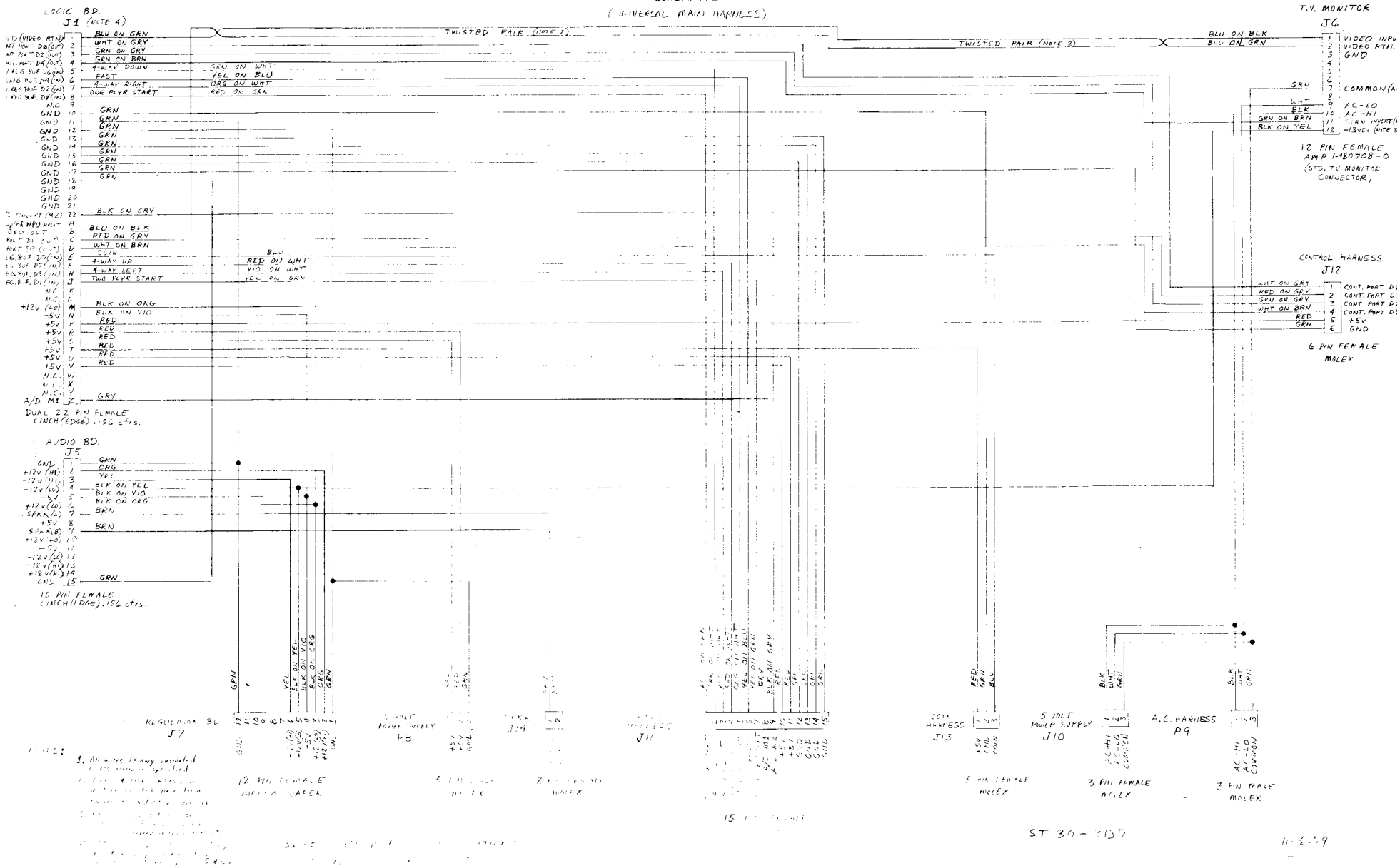

ST 30-1137

11-2-79

SIDE TRAK
CONTROL PANEL HARNESS
SCHEMATIC

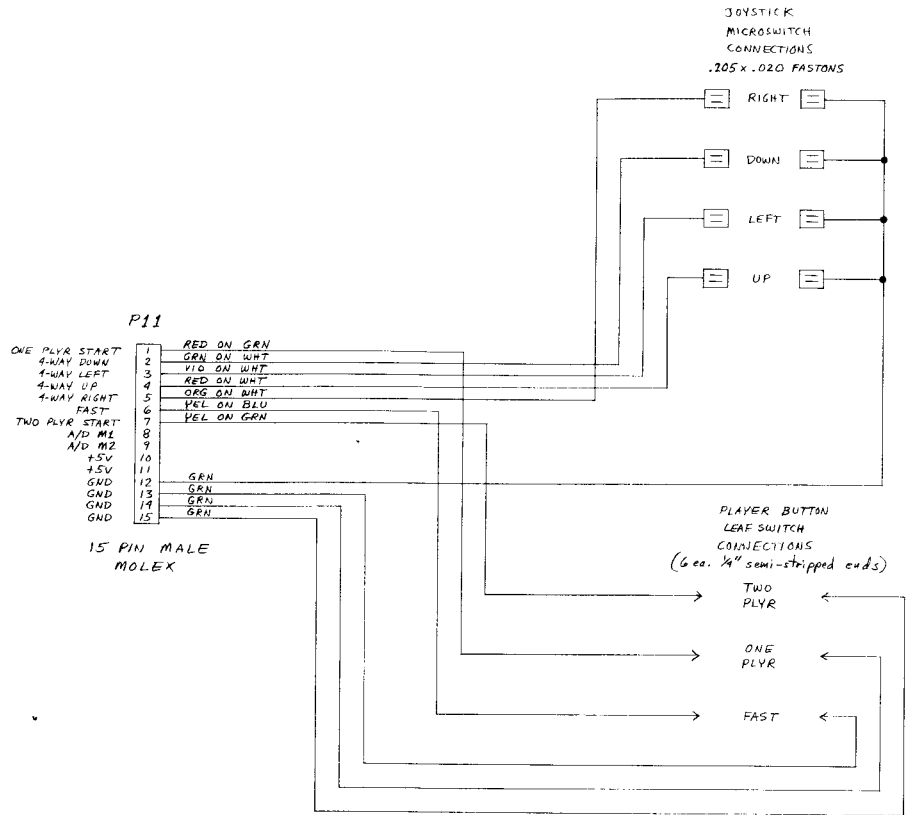

- NOTES:
1. All wires 22 awg. insulated unless otherwise specified.
 2. ABSOLUTELY NO SUBSTITUTIONS ON SPECIFIED WIRE COLORS

ST 30-3188

11-6-79

SIDE TRAK
COIN HARNESS SCHEMATIC
(UNIVERSAL COIN
HARNESS)

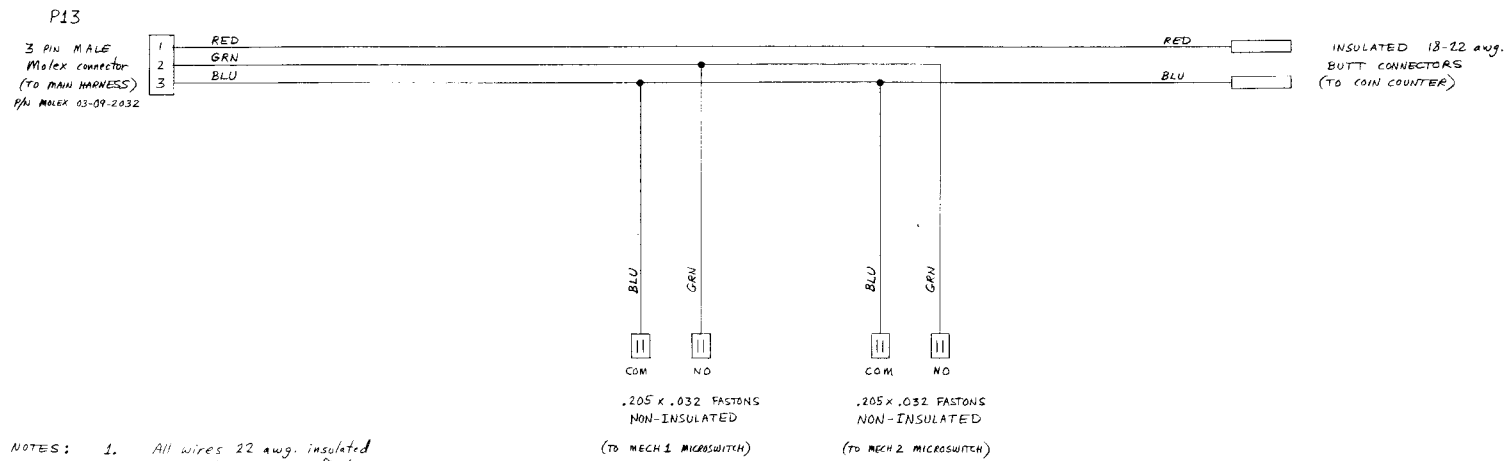

- NOTES:
1. All wires 22 awg. insulated unless otherwise specified.
 2. ABSOLUTELY NO SUBSTITUTIONS ON SPECIFIED WIRE COLORS

ST 30-3189

11-6-79