

SEGA[™]
SPIDER-MAN

The Video Game

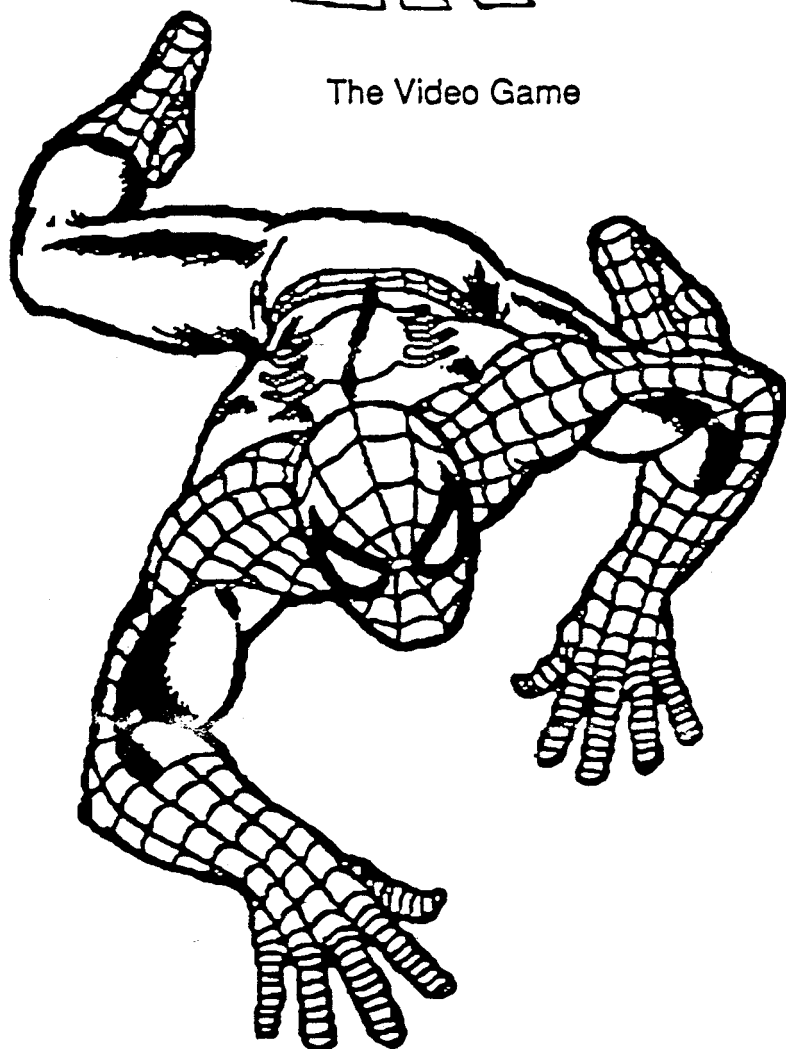

4 Player Upright

Owner's Installation and Operating Manual
SEGA ENTERPRISES, INC. U.S.A.

999-0114

SPIDER-MAN

The Video Game

BY:

SEGA Enterprises, Inc. (U.S.A.)

2149 Paragon Drive

San Jose, California 95131

Phone Number: (408) 435-0201

FAX Number (408) 435-0294

SPECIFICATIONS

HEIGHT:	70.5 in.
WIDTH:	36.5 in. (with Control Panel)
WIDTH	25.5 in. (w/o Control Panel)
DEPTH:	38.5 in.
NET WEIGHT:	275 lbs.
POWER	360 warts
VOLTAGE	120 volts AC
CURRENT	3 Amps

Note: This equipment has been tested and found to comply with the limits for a Class A digital device, pursuant to Part 15 of the FCC Rules. These limits are designed to provide reasonable protection against harmful interference when the equipment is operated in a commercial environment. This equipment generates, uses, and can radiate radio frequency energy and, if not installed and used in accordance with the instruction manual, may cause harmful interference to radio communications. Operation of this equipment in a residential area is likely to cause harmful interference in which case the user will be required to correct the interference at his/her own expense.

Table of Contents

SPECIFICATIONS.....	2
INTRODUCTION OF THE OWNER'S MANUAL.....	4
HANDLING PRECAUTIONS.....	4
PREVENTION OF COUNTERFEITING AND CONVERSION	5
LABELLING	5
ORIGINAL SEAL	5
COPYRIGHT NOTICE	5
PRECAUTIONS CONCERNING THE PLACE OF INSTALLATION.....	6
F.C.C. REQUIREMENTS	6
SERVICE SWITCHES.....	7
SYSTEM 32 BOARD.....	7
TEST MODE.....	8
SELECTION OF TEST ITEMS.....	8
MEMORY TEST.....	9
INPUT TEST.....	9
SOUND TEST.....	10
RGB COLOR CHECK.....	10
C.R.T. TEST.....	11
GAME ASSIGNMENTS	11
COIN ASSIGNMENTS.....	12
MANUAL SETTING.....	13
COIN/CREDIT SETTING.....	14
MANUAL SETTINGS.....	15
BOOKKEEPING 1/2.....	16
SCORING INFORMATION.....	17
BACKUP BOOKKEEPING DATA.....	17
SPIDER-MAN PRINTED CIRCUIT BOARD ASSY.....	18
FILTER BOARD.....	19
MONITOR ADJUSTMENTS	21
IN CASE OF DIFFICULTY.....	22
PARTS LIST	24
WIRING DIAGRAM.....	26

NOTE: DESCRIPTIONS HEREIN CONTAINED MAY BE SUBJECT TO IMPROVEMENT OR CHANGES WITHOUT NOTICE.

INTRODUCTION OF THE OWNER'S MANUAL

SEGA ENTERPRISES, LTD., supported by its high electronic technology of LSIs, microprocessors, etc. and a wealth of experience, has for more than 30 years been supplying various innovative and popular game machines to the world market. This OWNER'S manual is intended to provide detailed comments together with all the necessary information covering the operation in general of electronic assemblies, electromechanical servicing control, spare parts, etc. This manual is intended for those who have knowledge of electricity and technical expertise especially in ICs, CRTs, microprocessors, etc. Carefully read so as to acquire sufficient knowledge before working on the machine. Should there be a malfunction, non-technical personnel should under no circumstances touch the interior system.

HANDLING PRECAUTIONS

When installing or inspecting, be very careful of the following points and pay attention to ensure that the player can enjoy the game safely.

- o Be sure to turn the power off before working on the machine.
- o To insert or pull out the plug quickly is dangerous.
- o It is necessary to make sure that the power cord or the grounding wire is not exposed on the road, etc. in a manner so as to be dangerous. Make sure that grounding connections are made safely at the position where specified.
- o Do not use any fuse that does not meet the specified rating.
- o Make complete connections for the IC board and other connectors. Insufficient insertion is very dangerous.

Also, for the IC board circuit inspections, only the logic probe is allowed. The use of a tester is not permitted, so be careful in this regard. After confirming that there are no irregularities, turn the power ON.

PREVENTION OF COUNTERFEITING AND CONVERSION

LABELLING

To prevent counterfeits and conversions, the following labels are put on all the SEGA products.

When handling such goods, be sure to confirm the labels. They are used to prevent illegal acts such as the unauthorized copying of the products and the printed circuit boards thereof or carrying on business by manufacturing similar merchandise or by converting, selling or using such products or printed circuit boards.

The following seal is put on the machines manufactured by SEGA

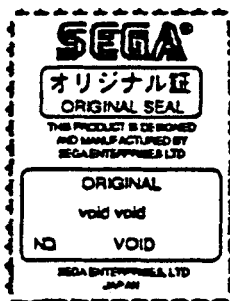

ORIGINAL SEAL

COPYRIGHT NOTICE

This SEGA product has the copyright notice as follows:

© SEGA 1991

This signifies that this work was disclosed in 1991 and is the property of
SEGA ENTERPRISES, LTD.

PRECAUTIONS CONCERNING THE PLACE OF INSTALLATION

This is an indoor game machine. Absolutely do not install it outside. Even indoors, avoid installing in places mentioned below so as to ensure proper usage:

- o Places subject to rain or water leakage, or condensation due to humidity.
- o In the proximity of an indoor swimming pool and/or shower.
- o Places subject to direct sunlight.
- o Places subject to heat sources from heating units, etc., or hot air.
- o Vicinity of highly flammable/volatile chemicals or hazardous matter.
- o Sloped surfaces.
- o Vicinity of anti-disaster facilities such as fire exits and fire extinguishers.
- o Places subject to any type of violent impact.
- o Dusty places.
- o Residential Environment - (See F.C.C. statement below)

F.C.C. REQUIREMENTS

The Federal Communications Commission requires that all Class A equipment be verified and labeled as follows:

This equipment complies with the requirements in part 15 of FCC Rules for a Class A computing device. Operation of this equipment in a residential area may cause unacceptable interference to radio and TV reception requiring the operator to take what ever steps are necessary to correct the interference.

This label must be permanently attached in a conspicuous location and the text must be legible. If this label is removed or tampered with, such action is punishable under Section 503 of the Communications Act of 1934 (ACT), as amended.

SERVICE SWITCHES

When you open the Coin Chute Door, you will notice three switches. From left to right, the first is the Volume Control, second is the Service Switch and the third is the Test Switch. (These switches are also referred to as buttons when explaining the Test Mode functions.)

Volume Control Pot: Controls the volume of the speakers.

Service Switch: Allows you to receive game credits to test the function of the game while maintaining the integrity of the Coin Credit meter. This is used when servicing the game.

Test Switch: Used in the Test Mode functions.

SYSTEM 32 BOARD:

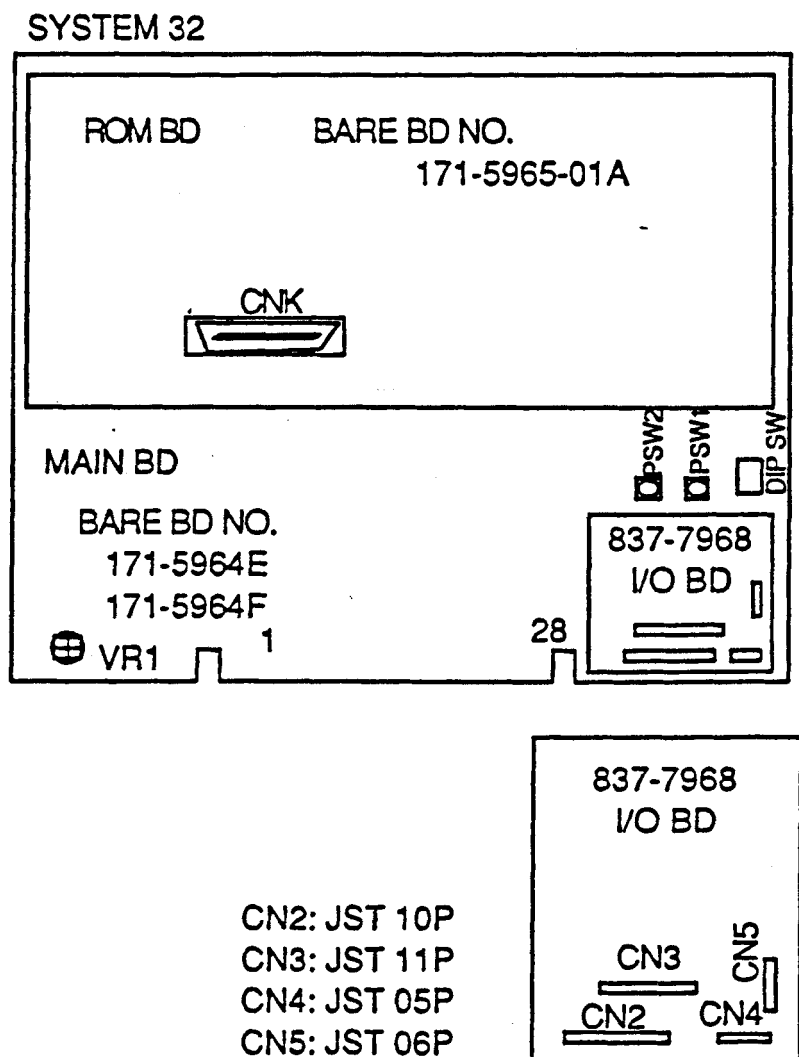

The four player game has a white start button for each player, one red button to control the attack feature, one yellow button to control the jump feature and an eight way joystick.

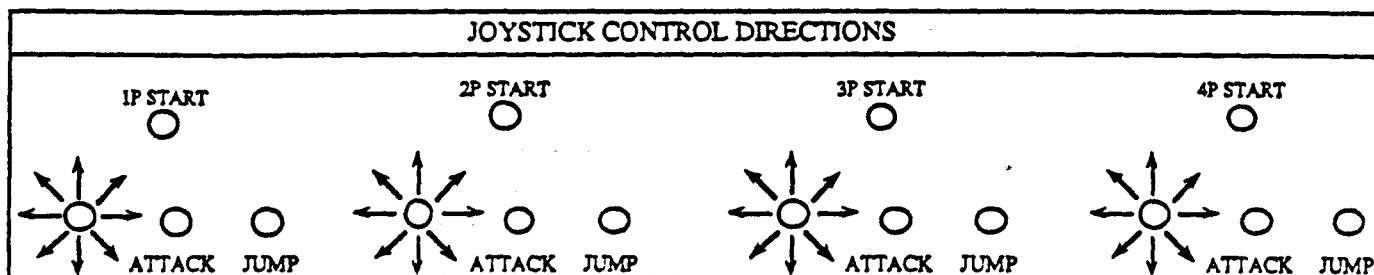

TEST MODE

The test operation of this game allows you to verify operation of the game memory, input, sound, CRT, and game assignments. The test mode also includes coin assignments, and bookkeeping functions.

Selection of Test Items:

1. Push the TEST SW to cause the following TEST ITEM MENU to appear:

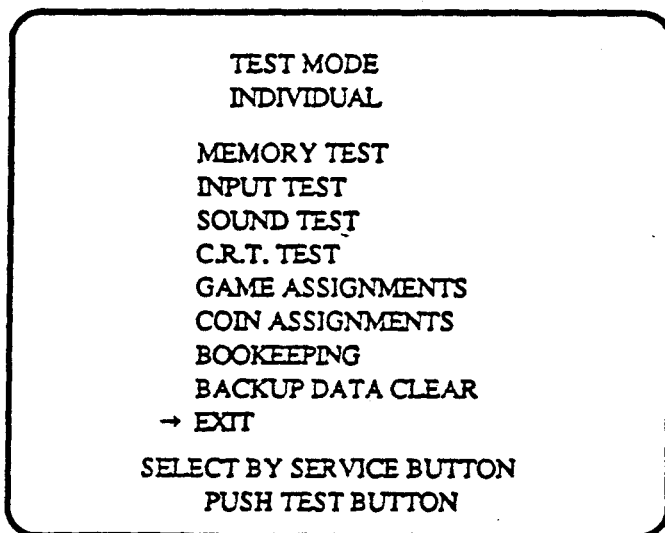

2. When you push the service switch, the arrow (→) will move to the next item on the menu.
3. Press the Test Button to perform the selected function.

Memory Test. When this item is selected, a list of Integrated Circuits will appear. Each item will display "Good" or "Bad" to indicate whether or not the IC is functioning properly. If "Bad" appears, it indicates a malfunctioning IC.

```

MEMORY TEST

<ROM>
IC6 GOOD IC7 GOOD
IC13 GOOD IC14 GOOD
<RAM>          IC16 GOOD
IC36 GOOD IC37 GOOD
IC61 GOOD IC62 GOOD
IC63 GOOD IC64 GOOD
IC65 GOOD IC66 GOOD
IC68 GOOD IC69 GOOD
IC70 GOOD IC71 GOOD
IC74 GOOD IC75 GOOD

PUSH TEST BUTTON TO EXIT
  
```

Input Test. This test indicates the condition of each switch and potentiometer. To test a switch, operate it. When the switch is in good operating condition, the "Off" will change to "On". If it does not change, it indicates a malfunctioning switch.

```

INPUT TEST

PLAYER  1P  2P  3P  4P

  UP    Off  Off  Off  Off
  DOWN  Off  Off  Off  Off
  RIGHT Off  Off  Off  Off
  LEFT  Off  Off  Off  Off
  ATTACK Off  Off  Off  Off
  JUMP  Off  Off  Off  Off
  START Off  Off  Off  Off
  CON   Off  Off  Off  Off

SERVICE-Off          TEST-Off
PUSH TEST BUTTON TO EXIT
  
```

Sound Test. The sound test indicates whether or not the sound in each category is working properly or not. Select the item using the Service Button and then push the Test Button.

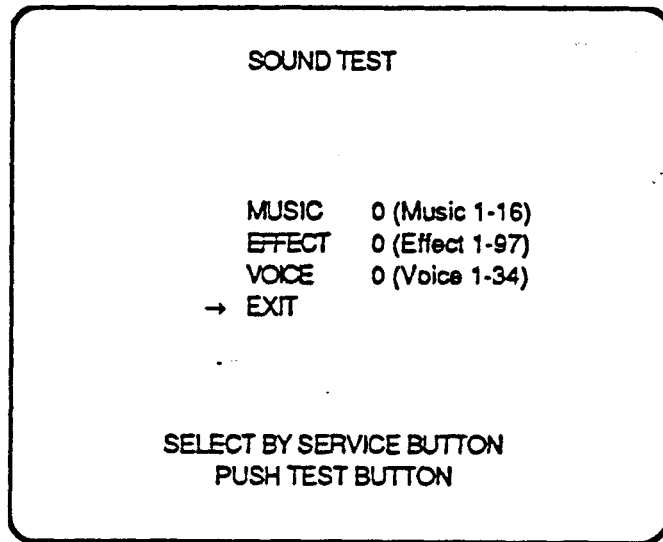

RGB Color Check. The CRT test allows you to adjust the color of the monitor. The color becomes brighter from left to right.

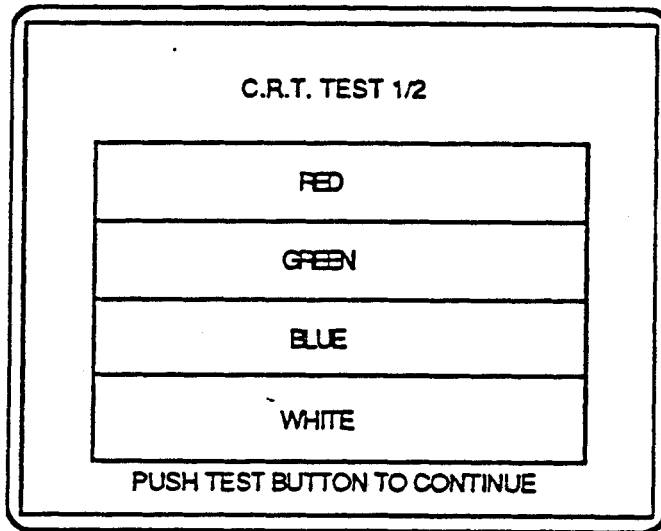

C.R.T. Test. View the image and make sure that all corners are straight. If the corners are not straight, make the necessary adjustments.

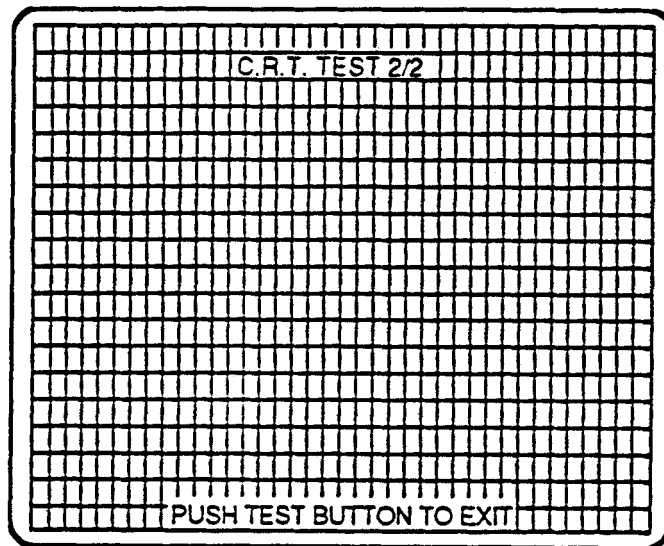

Game Assignments.

The monitor allows you to adjust game assignments as follows:

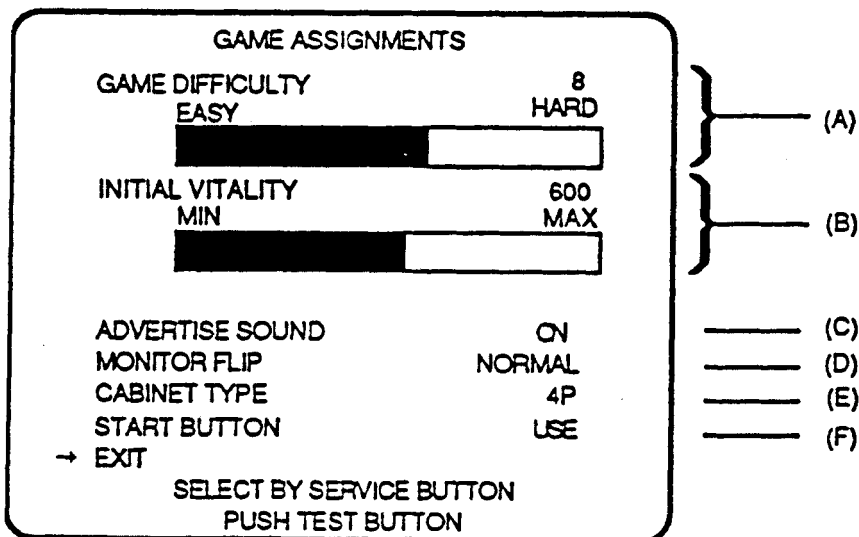

- A. **Game Difficulty:** Values range from 1 to 8. The higher the number, the more difficult the game play. Default setting is 5.
- B. **Vitality:** Values range from 200 to 600. The default setting is 400.

- C. Advertise Sound: Allows you to turn the advertising sound on or off. Default is Off.
- D. Monitor Flip: Should be set to normal.
- E. Cabinet Type: Should be set to 4P.
- F. Start Button: Should be set to Use.

Coin Assignments.

The coin chute type is set to individual. The credit to start play is two credits. One coin per chute equals one credit per chute. Fifteen different types of coin credits can be selected. See the coin/chute setting matrix on page 15.

COIN ASSIGNMENTS	
COIN CHUTE TYPE	INDIVIDUAL
CREDIT TO START	2 CREDITS
COIN/CREDIT SETTING	#1
COIN CHUTE #1	1 COIN 1 CREDIT
COIN CHUTE #2	1 COIN 1 CREDIT
MANUAL SETTING	
→ EXIT	
SELECT BY SERVICE BUTTON AND PUSH TEST BUTTON	

Manual Setting. The coin to credit, Bonus Adder information and coin chute multiplier are displayed. Select the item by using the Service Button and then push the Test Button to perform the selected function.

COIN ASSIGNMENTS
MANUAL SETTING

COIN TO CREDIT	1	COIN	1	CREDIT
BONUS ADDER		NO	BONUS	ADDER
COIN CHUTE			MULTIPLIER	
COIN		1	COIN	COUNTS AS 1 COIN

1 2 3 4 5 6 7 8 9
1 2 3 4 5 6 7 8 9

CREDIT
→ EXIT

SELECT BY SERVICE BUTTON
AND PUSH TEST BUTTON

COIN/CREDIT SETTING
(COIN CHUTE INDIVIDUAL TYPE)

SETTING #1	1 COIN	1 CREDIT
SETTING #6	1 COIN	2 CREDITS
SETTING #8	1 COIN	3 CREDITS
SETTING #9	1 COIN	4 CREDITS
SETTING #10	1 COIN	5 CREDITS
SETTING #11	1 COIN	6 CREDITS
SETTING #12	2 COINS	1 CREDIT
SETTING #15	1 COIN	1 CREDIT
	2 COINS	3 CREDITS
SETTING #17	3 COINS	1 CREDIT
SETTING #18	4 COINS	1 CREDIT
SETTING #19	1 COIN	1 CREDIT
	2 COINS	2 CREDITS
	3 COINS	3 CREDITS
	4 COINS	5 CREDITS
SETTING #21	3 COINS	1 CREDIT
	5 COINS	2 CREDITS
SETTING #22	2 COINS	1 CREDIT
	4 COINS	2 CREDITS
	5 COINS	3 CREDITS
SETTING #24	1 COIN	1 CREDIT
	2 COINS	2 CREDITS
	3 COINS	3 CREDITS
	4 COINS	4 CREDITS
	5 COINS	6 CREDITS
SETTING #26	FREE PLAY	

MANUAL SETTINGS

COIN TO CREDIT	1 COIN	1 CREDIT
	2 COINS	1 CREDIT
	3 COINS	1 CREDIT
	4 COINS	1 CREDIT
	5 COINS	1 CREDIT
	6 COINS	1 CREDIT
	7 COINS	1 CREDIT
	8 COINS	1 CREDIT
	9 COINS	1 CREDIT

BONUS ADDER	NO BONUS ADDER
	2 COINS GIVE 1 EXTRA COIN
	3 COINS GIVE 1 EXTRA COIN
	4 COINS GIVE 1 EXTRA COIN
	5 COINS GIVE 1 EXTRA COIN
	6 COINS GIVE 1 EXTRA COIN
	7 COINS GIVE 1 EXTRA COIN
	8 COINS GIVE 1 EXTRA COIN
	9 COINS GIVE 1 EXTRA COIN

COIN CHUTE #1 MULTIPLIER	1 COIN COUNTS AS 1 COIN
	1 COIN COUNTS AS 2 COINS
	1 COIN COUNTS AS 3 COINS
	1 COIN COUNTS AS 4 COINS
	1 COIN COUNTS AS 5 COINS
	1 COIN COUNTS AS 6 COINS
	1 COIN COUNTS AS 7 COINS
	1 COIN COUNTS AS 8 COINS
	1 COIN COUNTS AS 9 COINS

COIN CHUTE #2 MULTIPLIER	1 COIN COUNTS AS 1 COIN
	1 COIN COUNTS AS 2 COINS
	1 COIN COUNTS AS 3 COINS
	1 COIN COUNTS AS 4 COINS
	1 COIN COUNTS AS 5 COINS
	1 COIN COUNTS AS 6 COINS
	1 COIN COUNTS AS 7 COINS
	1 COIN COUNTS AS 8 COINS
	1 COIN COUNTS AS 9 COINS

Coin chute #3 and coin chute #4 multipliers are the same as for #1 and #2 above.

Bookkeeping 1/2. The Coin Chutes #1 through #4 are displayed with the total number of coin drops recorded per chute. The total of all four chutes is recorded under Total Coin. Coin Credits are displayed and the number of times the service switch has been used to gain credits is also recorded. The total of both types of credits are recorded under Total Credit.

Number of Games: displays the number of times the game has been played. Total Operating time is displayed in days, hours, minutes and seconds. The total game playing time is displayed in a like fashion. Average game length , Longest game time, and Shortest game time are displayed in hours, minutes and seconds. The utilization factor is displayed as a percentage. To continue, push the Test Button.

BOOKKEEPING 1/2	
COIN CHUTE #1	0
COIN CHUTE #2	0
COIN CHUTE #3	0
COIN CHUTE #4	0
TOTAL COINS	0
COIN CREDITS	0
SERVICE CREDITS	0
TOTAL CREDITS	0
NUMBER OF GAMES	0
TOTAL OP. TIME	0d 0h 0m 0s
TOTAL GAME TIME	0d 0h 0m 0s
AVERAGE GAME TIME	0h 0m 0s
LONGEST GAME TIME	0h 0m 0s 0m 0s
SHORTEST GAME TIME	0h
UTILIZATION FACTOR	0.0%
PUSH TEST BUTTON TO CONTINUE	

Scoring information is displayed below. The average score, highest score, and the lowest score ranges are also displayed. To exit, push the Test Button.

BOOKKEEPING 2/2	
Time Histogram	
0m00s~0m29s	0
0m30s~0m59s	0
1m00s~1m29s	0
1m30s~1m59s	0
2m00s~2m29s	0
2m30s~2m59s	0
3m00s~3m29s	0
3m30s~3m59s	0
4m00s~4m29s	0
4m30s~4m59s	0
5m00s~9m59s	0
OVER 10m00s	0
AVERAGE SCORE	0
HIGHEST SCORE	0
LOWEST SCORE	0
PUSH TEST BUTTON TO EXIT	

If you wish to delete all backup bookkeeping data, simply select YES and push the Test Button. Otherwise, select No and push the Service Button.

BACKUP DATA CLEAR	
YES	
→ NO	
SELECT BY SERVICE BUTTON AND PUSH TEST BUTTON	

The following is a diagram of the Spider-Man Printed Circuit Board Assy #833-8331-04.

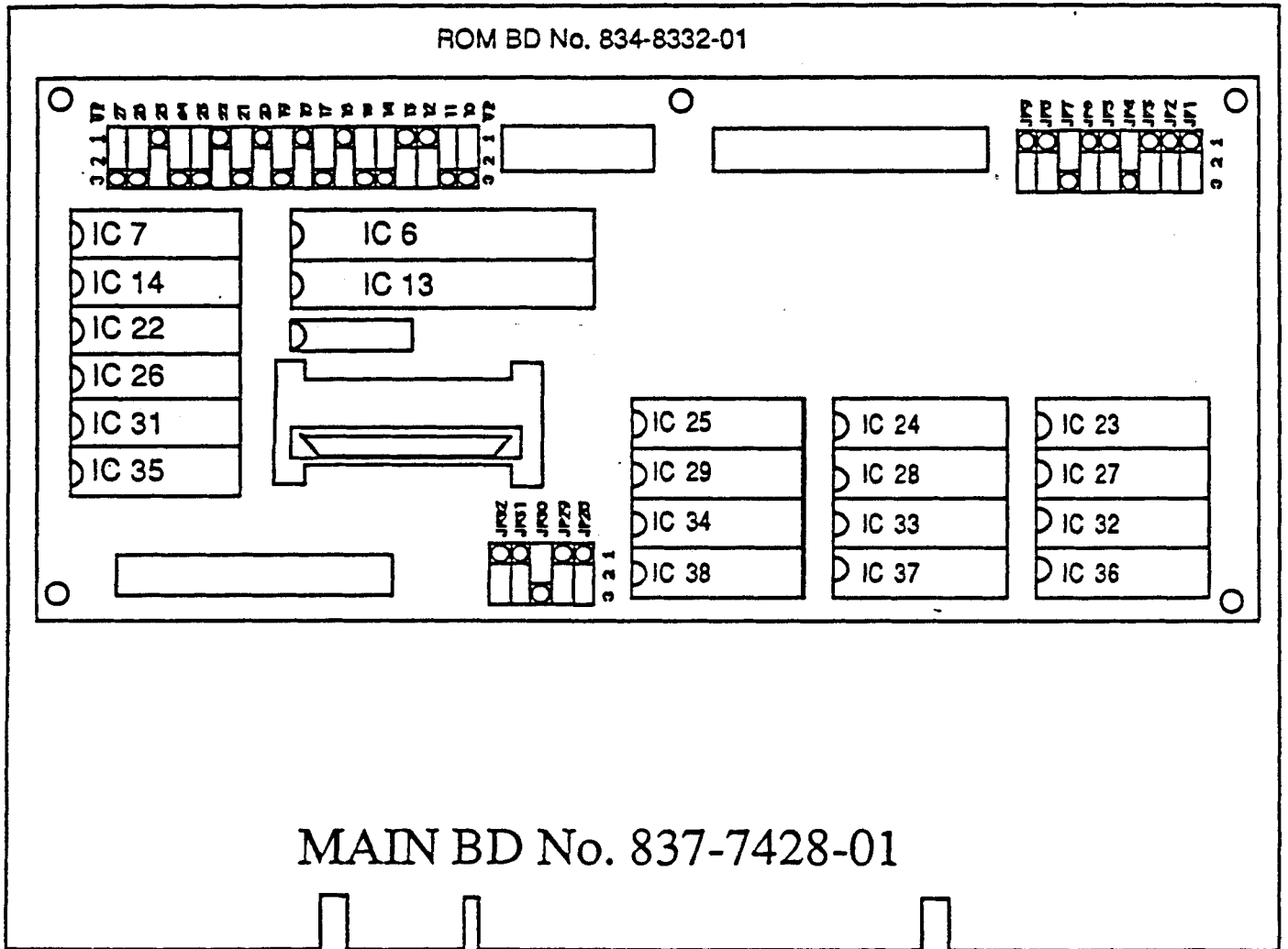

FILTER BOARD:

SPIDER-MAN FILTER BOARD 839-0207

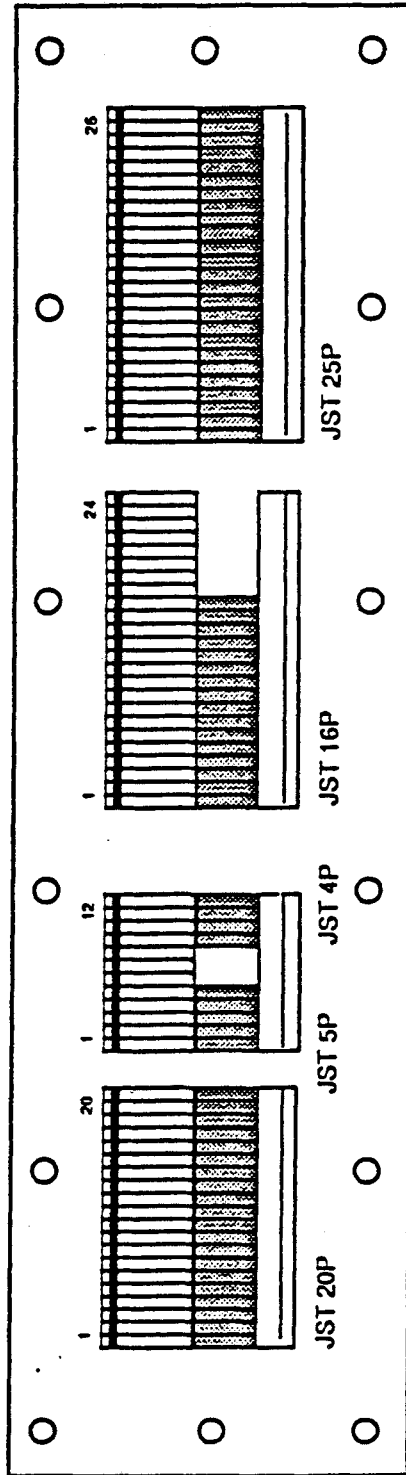

The following matrix displays the location of each IC, its primary function.

SPIDER-MAN

IC LOCATION	FUNCTION
IC 7 IC 14 IC 6 IC 13	MAIN PROGRAM
IC 22 IC 26 IC 31 IC 35	SOUND
IC 25 IC 29 IC 34 IC 38	SCROLL
IC 24 IC 28 IC 33 IC 37 IC 23 IC 27 IC 32 IC 36	OBJECT

Monitor Adjustments

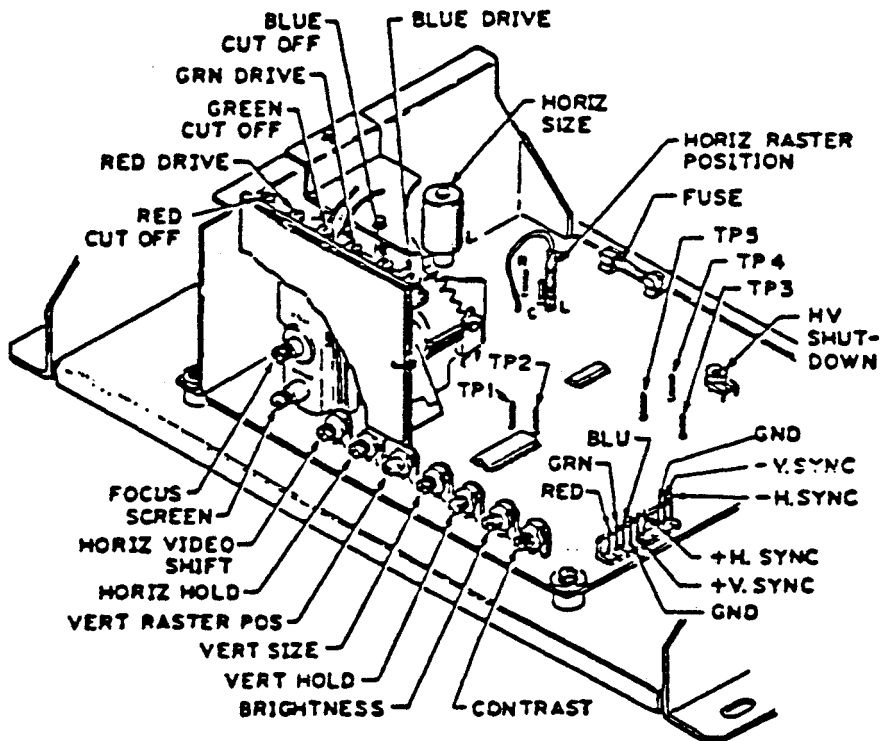
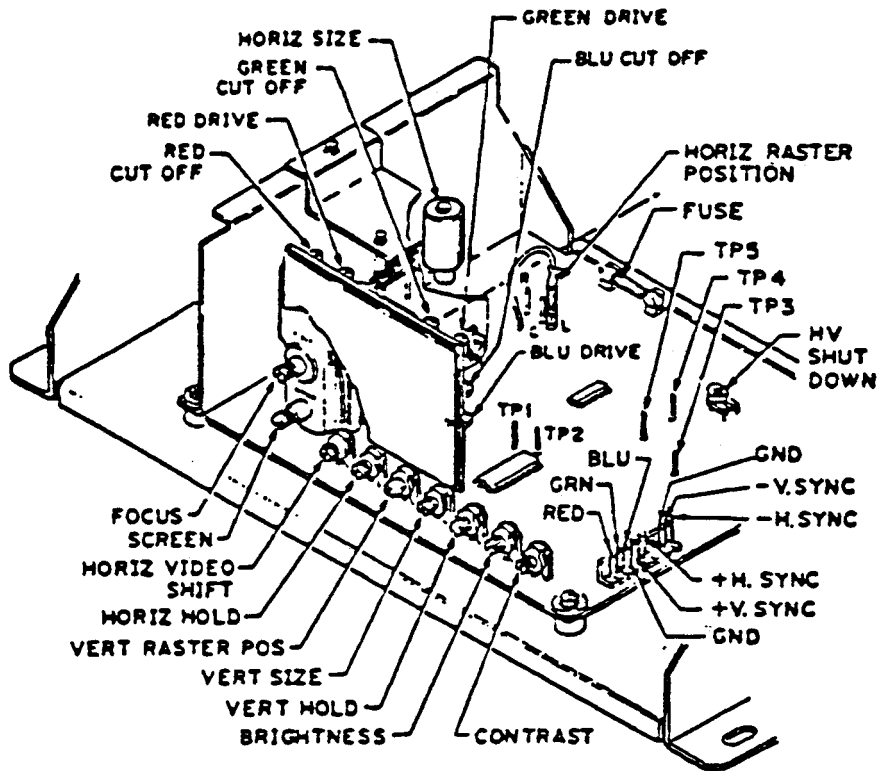

In Case of Difficulty

No Raster/No Video

- Check A.C. line cord
- Check line fuse
- Check monitor brightness
- Check power switch and/or interlock switch
- Check all solder connections on line filter and transformer
- Check for proper orientation of the 56 pin PCB connector

Raster/No Video

- Check all PCB to monitor connections
- Check power supply voltage on PCB

No Video/Game sounds can be heard

- Check monitor brightness
- Check all PCB to monitor connections

Incorrect Colors

- Monitor needs degaussing
- Check for proper wiring between PCB and monitor
- Check monitor adjustment and adjust if necessary

Wavy Picture

- Check monitor ground is properly connected to monitor
- Be certain sync inputs are properly connected to monitor
- Check horizontal hold adjustment

Vertical Roll/Horizontal Tear

- Check horizontal and/or vertical hold adjustments
- Check for proper wiring of sync from PCB to monitor

No Sound

- Check volume control potentiometer adjustment
- Check for + 12 volts on edge connector of PCB
- Check wiring from PCB to speaker
- Check speaker for low resistance between the "+" and "-" tabs

Bad Sound

- Check wiring to speaker for bad solder connections
- Check sound with another speaker

No Switch Input

- Check ground connection to switches
- Check wiring between PCB and switches for proper connection
- Check switches with an-ohm meter to verify proper operation

Switch Operates Incorrect Function

- Check wiring between PCB and switches for proper orientation
- Check wiring for shorts between switch inputs

No Coin Meter

- Check wiring to coin meter
- Check that + 5 volts is on + side of meter
- Verify a + 5 volt meter is used

When coin switch is made and meter pulses, the screen blanks out and/or game resets

- Verify that a meter with a diode is used
- If no diode is built in meter a 1N4004 can be used across the meter. Cathode to "+" side of meter and anode to "-" side of meter.

Final Assembly, SPIDER-MAN # 999-0101

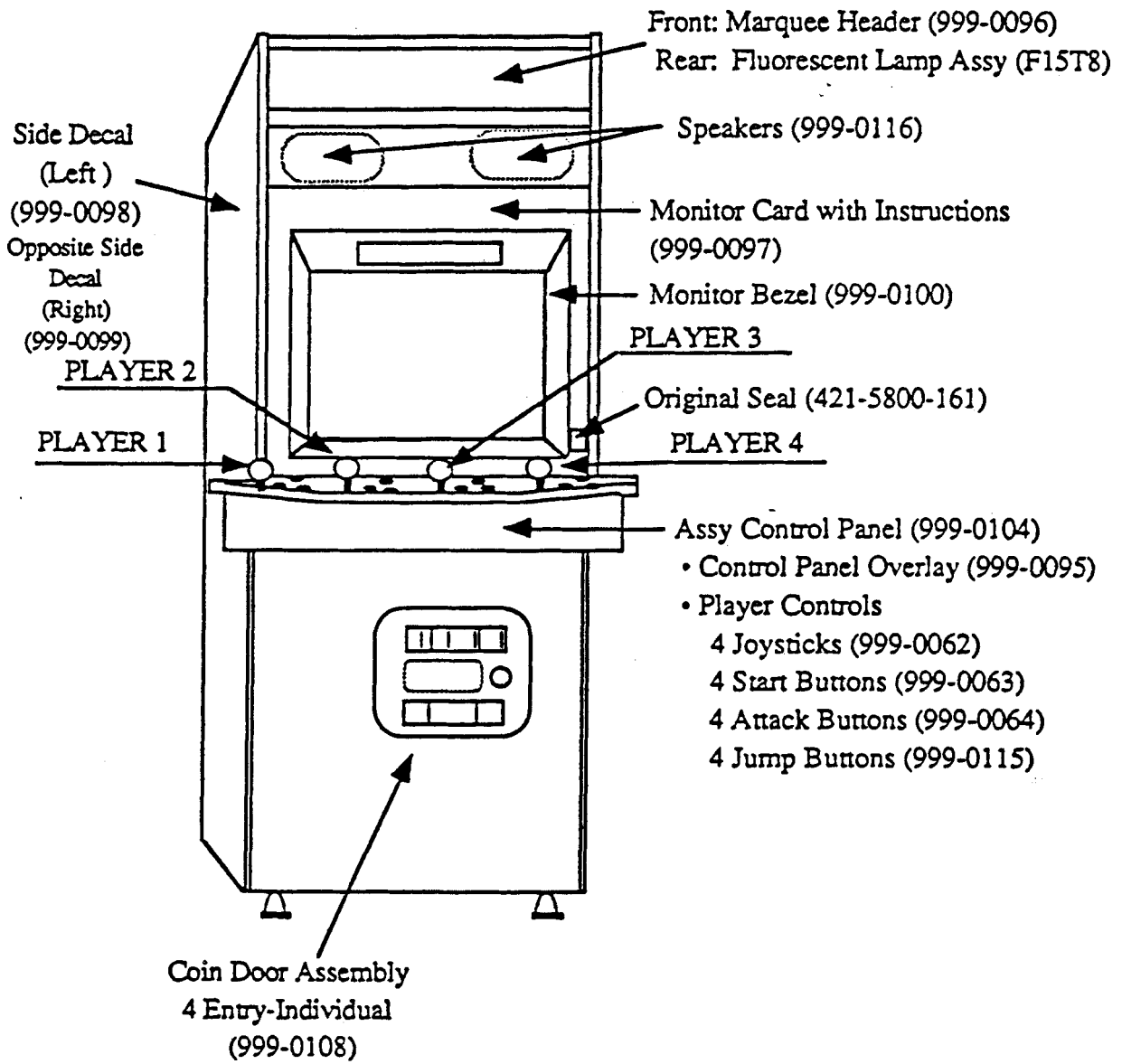

PARTS LIST

Part Number	Description	QTY
999-0101	Final Assy Cabinet	1
999-0102	Power Supply, Switching XT-150	1
25" Wells ST	Monitor, 25" Standard Resolution	1
999-0100	Bezel, Plastic	1
999-0116	Speaker 8 Ohm 15W (5x7)	2
999-0103	Assy, Trucking Wheel	2
999-0104	Assy, Control Panel	1
999-0095	Assy, Control Panel Overlay	1
999-0096	Marquee Header, Spider-Man U/R	1
999-0097	Monitor Card, w/ Play Instr.	1
999-0099	Side Decal (Right)	1
999-0098	Side Decal (Left)	1
999-0062	Joystick, 8-way	4
999-0064	Pushbutton, Red	4
999-0063	Pushbutton, White	4
999-0115	Pushbutton, Yellow	4
999-0105	Clamp, Control Panel	2
999-0106	Strike, Control Panel	2
999-0107	Assy, Control Panel Harness	1
999-0108	Assy, Coin Door 4 Entry	1
F15T8	Assy, Fluorescent Lamp (18" F15T/80W)	1
999-0109	Transformer, Isolation	1
999-0110	Fuse 1A Slow Blo	1
999-0111	Fuseholder, 1P	1
999-0112	Assy, Main Harness	1
600-5849-03	Wire Harness, JAMMA (Logic to Filter)	1
600-5891-10	Wire Harness, I/O (Logic to Filter)	1
833-8331-04	Assy, Spider-Man PCB	1
839-0207	Assy Filter PCB	1
999-0113	Monitor Glass (22-3/4 x 23-15/16 x 3/16)	1
999-0114	Owner's Manual, Spider-Man U/R	1

4 PLAYER TYPE

PIN ASSIGNMENT

JST 10P
(I/O BD CN 2)

1	3P UP
2	3P DOWN
3	3P LEFT
4	3P RIGHT
5	GND
6	3P ATTACK
7	3P JUMP
8	(NOT USED)
9	(NOT USED)
10	GND

JST 11P
(I/O BD CN 3)

1	4P UP
2	4P DOWN
3	4P LEFT
4	4P RIGHT
5	GND
6	4P ATTACK
7	4P JUMP
8	(NOT USED)
9	(NOT USED)
10	GND
11	

JST 05P
(I/O BD CN4)

1	3P START
2	4P START
3	(NOT USED) <COIN 3 (2P COIN)>
4	(NOT USED) <COIN 4 (1P COIN)>
5	GND

(JAMMA)

COMPONENT SIDE

SOLDER SIDE

GND	1	A	GND
GND	2	B	GND
+5V	3	C	+5V
+5V	4	D	+5V
(NOT USED)	5	E	(NOT USED)
+12V	6	F	+12V
KEY (NOT USED)	7	H	KEY (NOT USED)
COIN METER 1	8	J	COIN METER 2
(NOT USED)	9	K	(NOT USED)
SPEAKER (+)	10	L	SPEAKER (-)
(NOT USED)	11	M	(NOT USED)
RED	12	N	GREEN
BLUE	13	P	SYNC
GND (SYNC)	14	R	ALL SERVICE
TEST	15	S	(NOT USED)
<4P COIN> COIN 1	16	T	COIN 2 <3P COIN>
1P START	17	U	2P START
1P UP	18	V	2P UP
1P DOWN	19	W	2P DOWN
1P LEFT	20	X	2P LEFT
1P RIGHT	21	Y	2P RIGHT
1P ATTACK	22	Z	2P ATTACK
1P JUMP	23	a	2P JUMP
(NOT USED)	24	b	(NOT USED)
(NOT USED)	25	c	(NOT USED)
(NOT USED)	26	d	(NOT USED)
GND	27	e	GND
GND	28	f	GND

INDEX

- Advertise Sound 12
- Average game length 16
- backup bookkeeping data 17
- Bonus Adder 13
- Bookkeeping 1/2 16
- C.R.T. Test 11
- Cabinet Type 12
- Coin Assignments 12
- coin chute multiplier 13
- coin to credit, 13
- COIN/CREDIT SETTING 14
- FILTER BOARD 19
- Game Assignments 11
- Game Difficulty 11
- In Case of Difficulty 22
- individual 12
- Input Test 9
- Integrated Circuits 9
- Longest game time 16
- Manual Setting. 13
- MANUAL SETTINGS 15
- Memory Test. 9
- Monitor Adjustments 21
- Monitor Flip 12
- Number of Games 16
- PARTS LIST 24
- RGB Color Check 10
- Scoring information 17
- Service Switch 7
- SERVICE SWITCHES 7
- Shortest game time 16
- Sound Test. 10
- SPECIFICATIONS 2
- Spider-Man Printed Circuit Board Assy 18
- Start Button 12
- Test Button 8
- TEST ITEM MENU 8
- TEST MODE 8
- Test Switch 7
- total game playing time 16
- Total Operating time 16
- utilization factor 16
- Vitality 11
- Volume Control Pot 7
- Wiring Diagram 26
- Vitality 13
- Volume Control Pot 7