

1.0 - 0.5 - 0.25 - 0.125 - 0.0625 - 0.03125

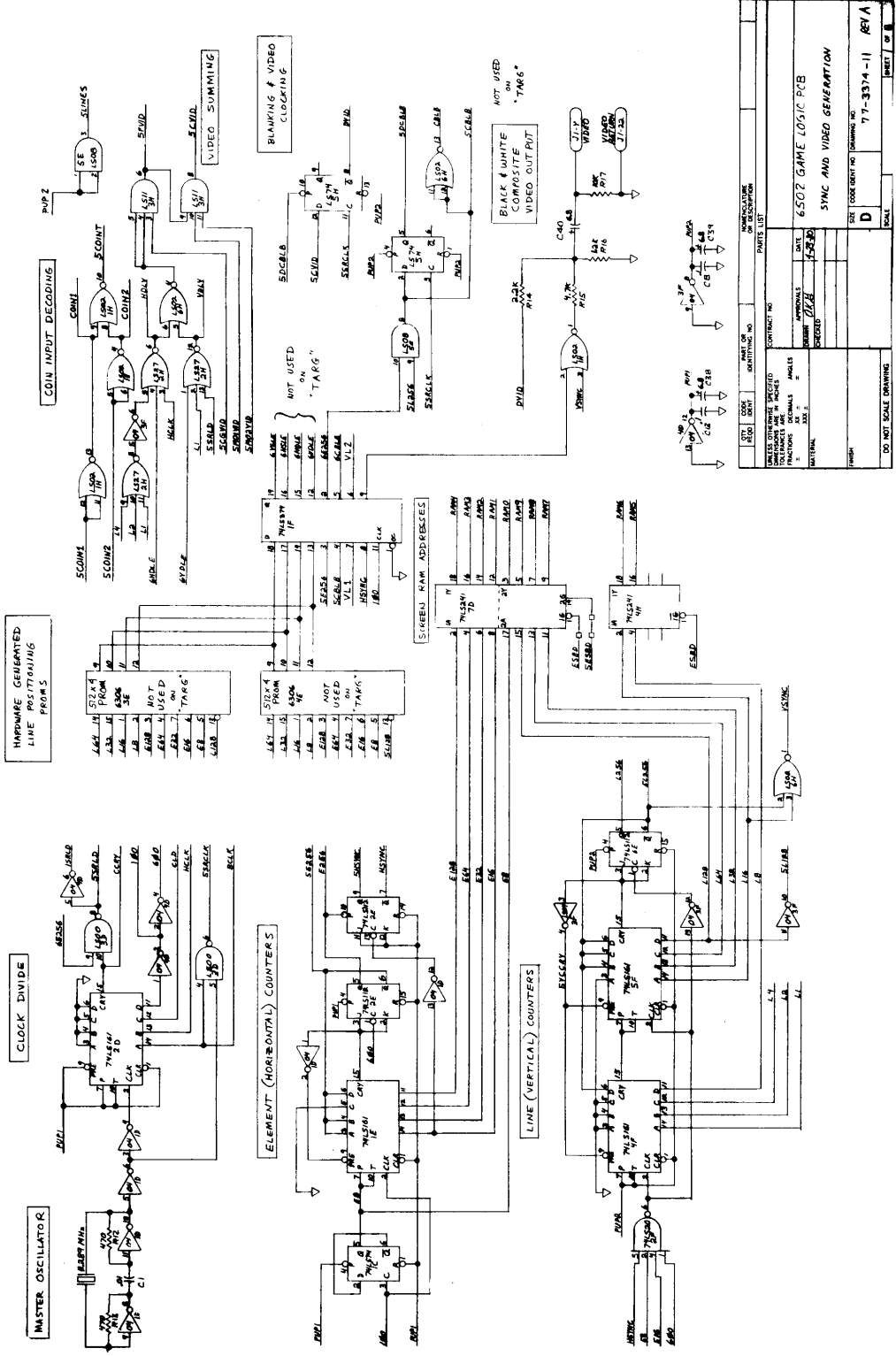

CONTRACT NO.		DATE	
6502 GAME LOGIC PCB		1968	
SYNCH AND VIDEO GENERATION		71-3314-11 REV A	
REVISIONS		SCALE	
1	ORIGINAL	D	1/1
2	REVISION		
3	REVISION		
4	REVISION		
5	REVISION		
6	REVISION		
7	REVISION		
8	REVISION		
9	REVISION		
10	REVISION		
11	REVISION		
12	REVISION		
13	REVISION		
14	REVISION		
15	REVISION		
16	REVISION		
17	REVISION		
18	REVISION		
19	REVISION		
20	REVISION		
21	REVISION		
22	REVISION		
23	REVISION		
24	REVISION		
25	REVISION		
26	REVISION		
27	REVISION		
28	REVISION		
29	REVISION		
30	REVISION		
31	REVISION		
32	REVISION		
33	REVISION		
34	REVISION		
35	REVISION		
36	REVISION		
37	REVISION		
38	REVISION		
39	REVISION		
40	REVISION		
41	REVISION		
42	REVISION		
43	REVISION		
44	REVISION		
45	REVISION		
46	REVISION		
47	REVISION		
48	REVISION		
49	REVISION		
50	REVISION		
51	REVISION		
52	REVISION		
53	REVISION		
54	REVISION		
55	REVISION		
56	REVISION		
57	REVISION		
58	REVISION		
59	REVISION		
60	REVISION		
61	REVISION		
62	REVISION		
63	REVISION		
64	REVISION		
65	REVISION		
66	REVISION		
67	REVISION		
68	REVISION		
69	REVISION		
70	REVISION		
71	REVISION		
72	REVISION		
73	REVISION		
74	REVISION		
75	REVISION		
76	REVISION		
77	REVISION		
78	REVISION		
79	REVISION		
80	REVISION		
81	REVISION		
82	REVISION		
83	REVISION		
84	REVISION		
85	REVISION		
86	REVISION		
87	REVISION		
88	REVISION		
89	REVISION		
90	REVISION		
91	REVISION		
92	REVISION		
93	REVISION		
94	REVISION		
95	REVISION		
96	REVISION		
97	REVISION		
98	REVISION		
99	REVISION		
100	REVISION		

DO NOT SCALE DRAWING

DATE: 1968

SCALE: 1/1

REV: A

71-3314-11

CHARACTER GENERATOR
IMAGE STORAGE RAMS

For use with PROGRAM
generated image storage master.

SEE "TAGS"

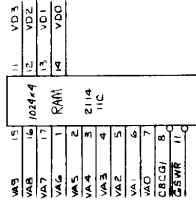
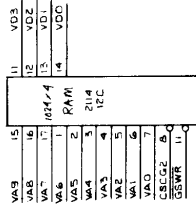
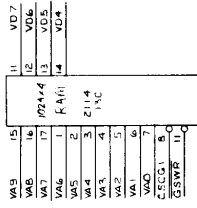
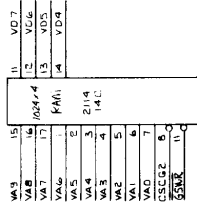

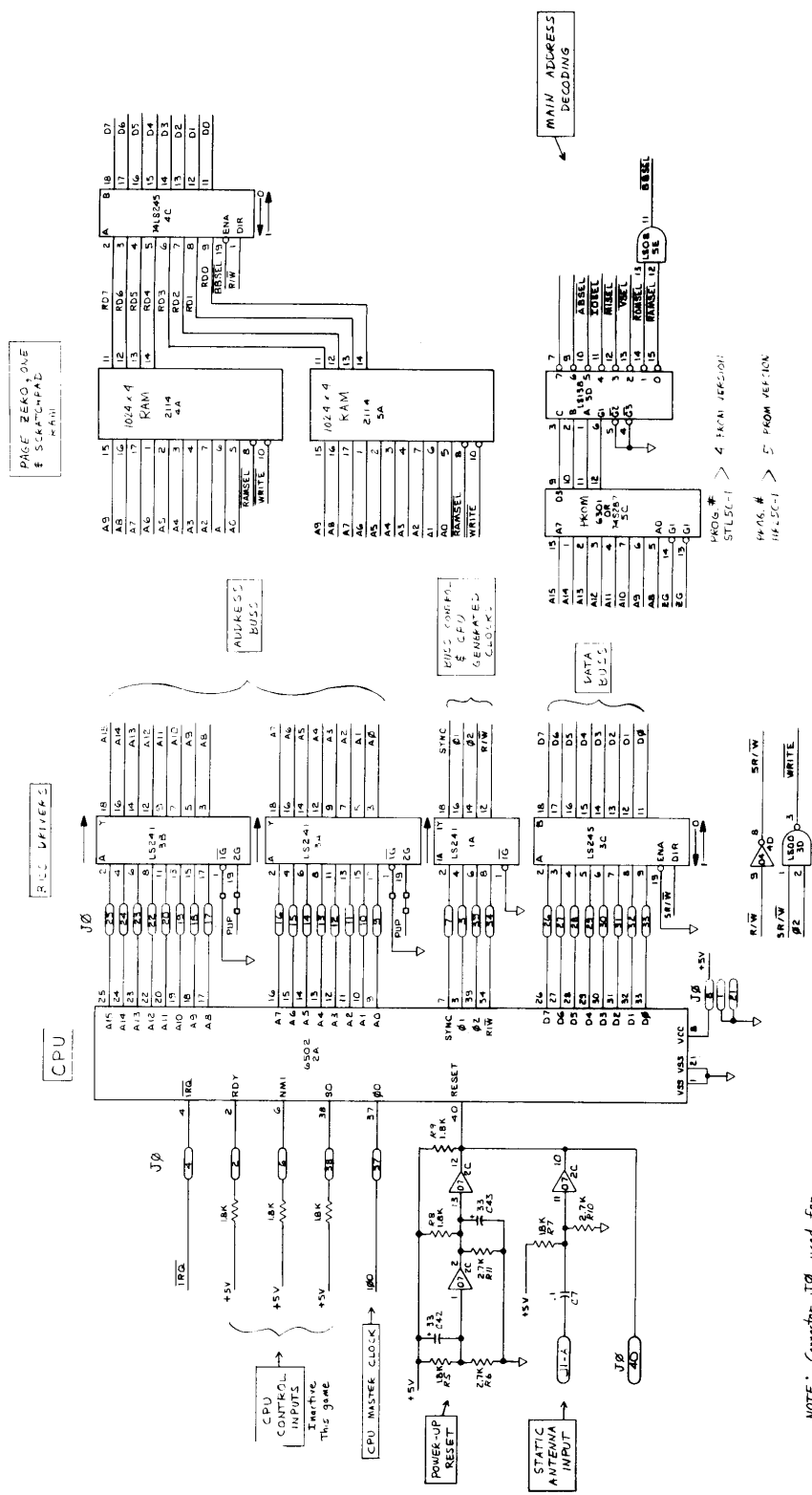

NOTE: Connector J0 used for test & analysis purposes only. Contains all CPU connections.

6502 GAME LOGIC PCB	
DATE	1-23-80
DESIGNED BY	PROGRAM MAN
TESTED BY	ARCHITECTURE
REV	408

PROGRAM MEMORY

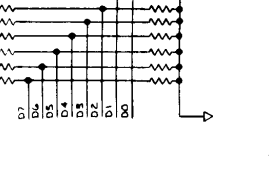
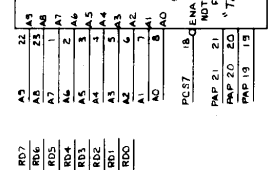
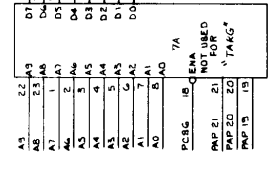
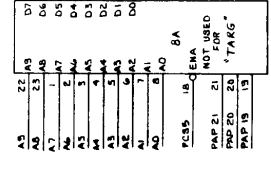
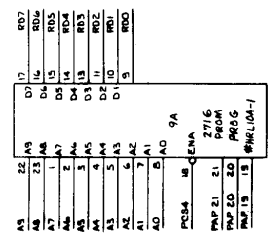
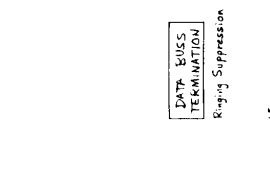
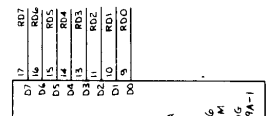
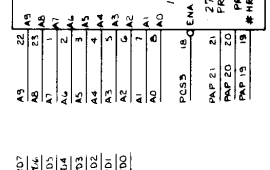
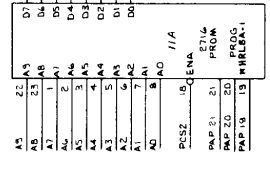
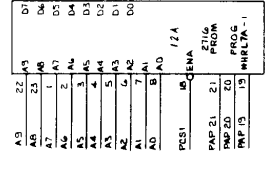
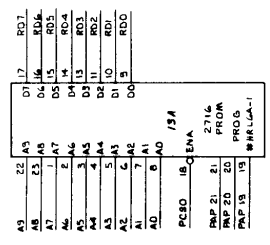

DATA BUS
TERMINATION
Ringing Suppression

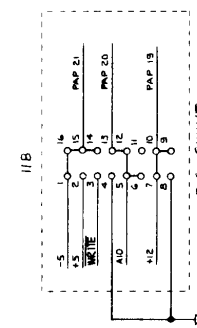
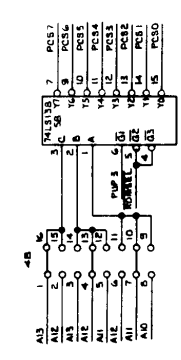
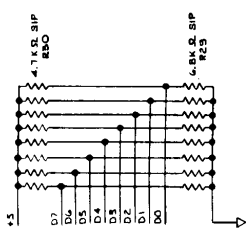

MEMORY DEVICE PERSONALITY
SELECTION
Configuration shown
for "TARG"

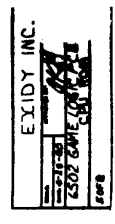

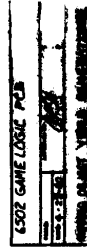
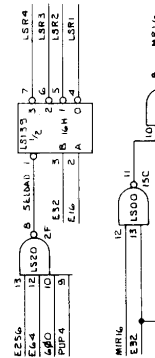
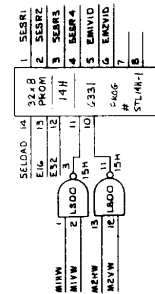
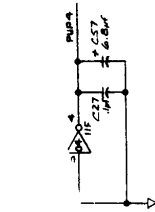
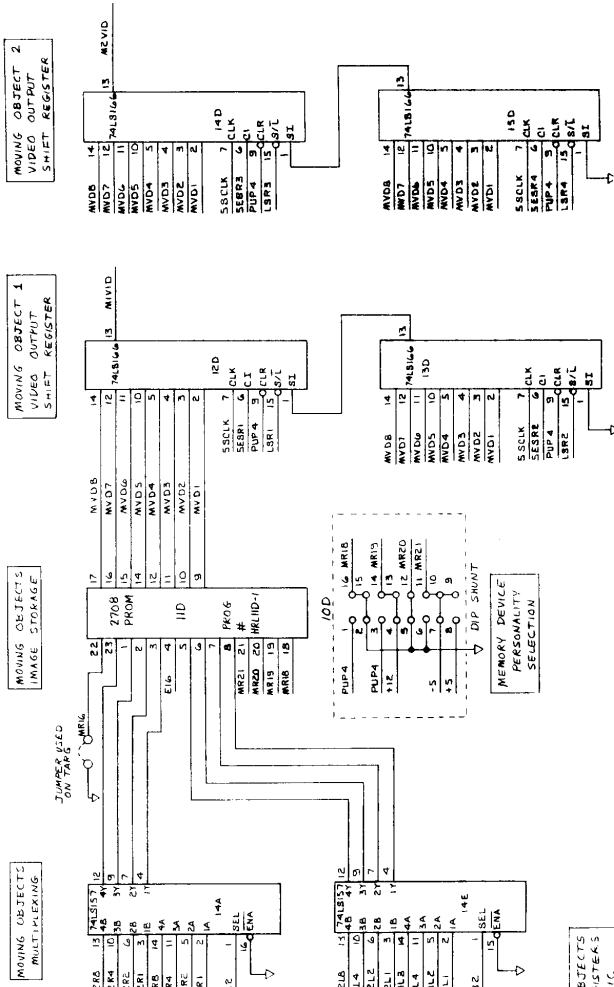

MOVING OBJECT 2
HORZ. COUNTERS

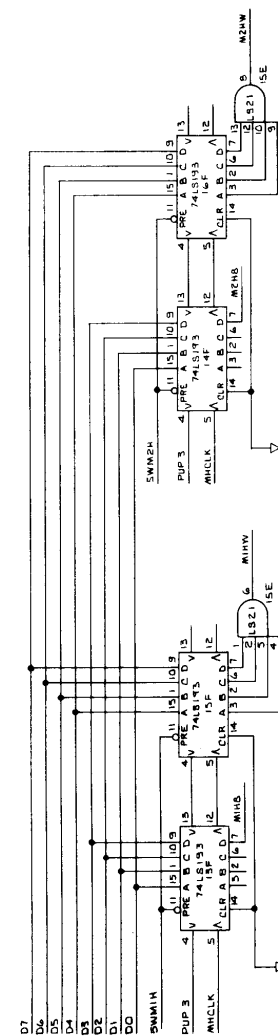

MOVING OBJECT 1
HORZ. COUNTERS

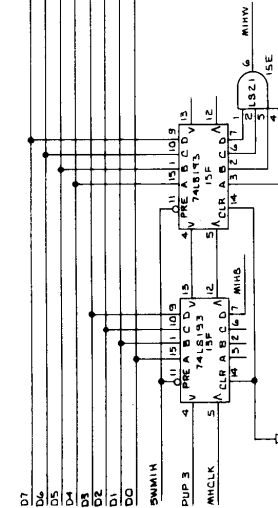

MOVING OBJECT 2
VERTICAL COUNTERS

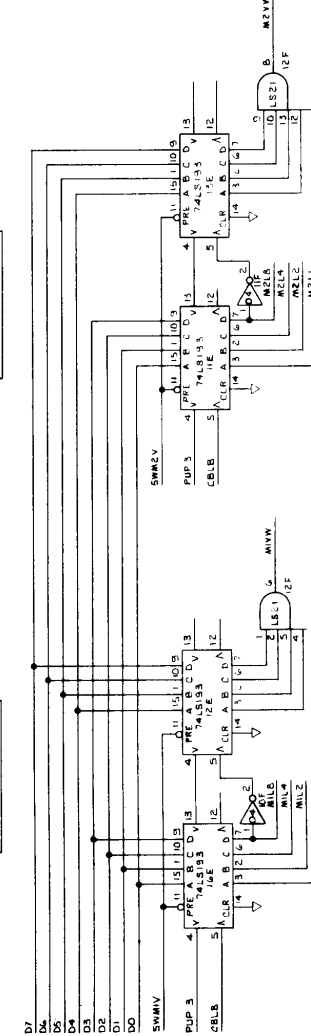

MOVING OBJECT 1
VERTICAL COUNTERS

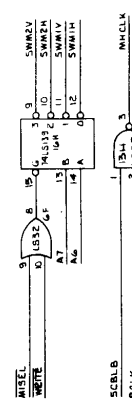
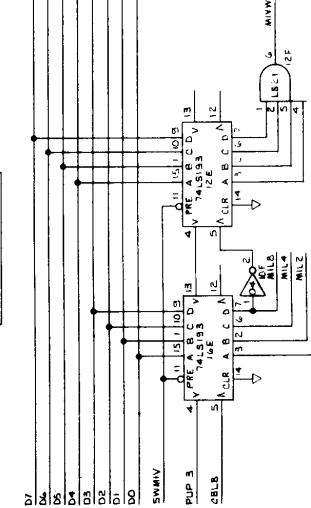

WRITE MOVING OBJECT DECODING

NOTE: FOR "TARG"
MOVING OBJECT 1 = PLAYER IMAGE (NUMBER)
MOVING OBJECT 2 = MISSILE

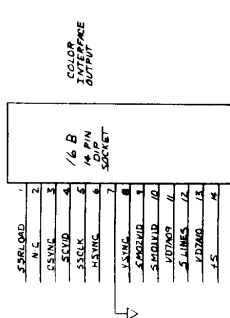

6702 GAME LOGIC PCB
6702
COLOR OUTPUTS
MOVING OBJECT PARTITION BOARD
8078

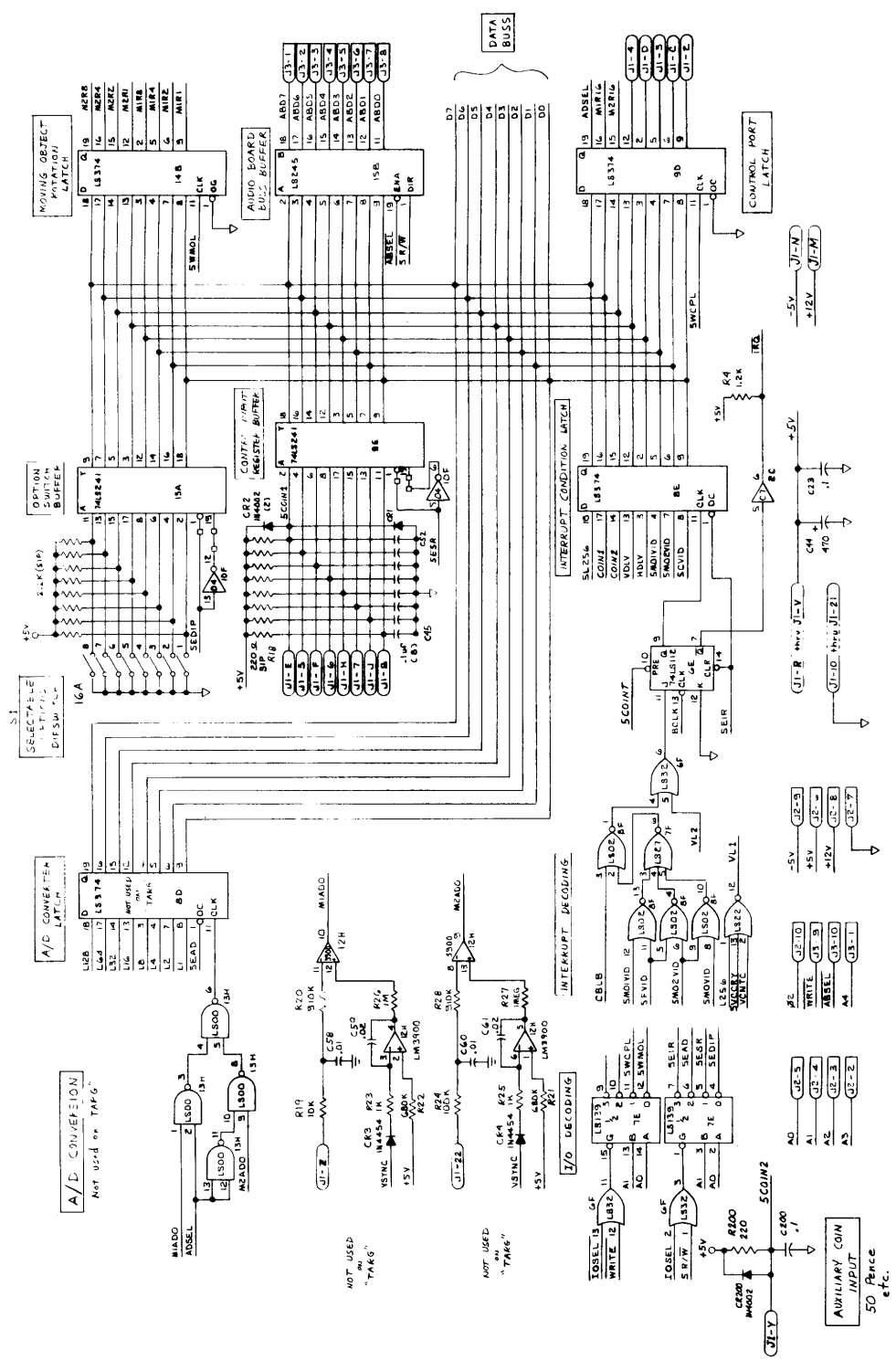

74181 ALU
 74182 MUX
 74180 MAJ
 74183 COMB
 74184 COMB
 74185 COMB
 74186 COMB
 74187 COMB
 74188 COMB
 74189 COMB
 74190 COMB
 74191 COMB
 74192 COMB
 74193 COMB
 74194 COMB
 74195 COMB
 74196 COMB
 74197 COMB
 74198 COMB
 74199 COMB
 74200 COMB
 74201 COMB
 74202 COMB
 74203 COMB
 74204 COMB
 74205 COMB
 74206 COMB
 74207 COMB
 74208 COMB
 74209 COMB
 74210 COMB
 74211 COMB
 74212 COMB
 74213 COMB
 74214 COMB
 74215 COMB
 74216 COMB
 74217 COMB
 74218 COMB
 74219 COMB
 74220 COMB
 74221 COMB
 74222 COMB
 74223 COMB
 74224 COMB
 74225 COMB
 74226 COMB
 74227 COMB
 74228 COMB
 74229 COMB
 74230 COMB
 74231 COMB
 74232 COMB
 74233 COMB
 74234 COMB
 74235 COMB
 74236 COMB
 74237 COMB
 74238 COMB
 74239 COMB
 74240 COMB
 74241 COMB
 74242 COMB
 74243 COMB
 74244 COMB
 74245 COMB
 74246 COMB
 74247 COMB
 74248 COMB
 74249 COMB
 74250 COMB
 74251 COMB
 74252 COMB
 74253 COMB
 74254 COMB
 74255 COMB
 74256 COMB
 74257 COMB
 74258 COMB
 74259 COMB
 74260 COMB
 74261 COMB
 74262 COMB
 74263 COMB
 74264 COMB
 74265 COMB
 74266 COMB
 74267 COMB
 74268 COMB
 74269 COMB
 74270 COMB
 74271 COMB
 74272 COMB
 74273 COMB
 74274 COMB
 74275 COMB
 74276 COMB
 74277 COMB
 74278 COMB
 74279 COMB
 74280 COMB
 74281 COMB
 74282 COMB
 74283 COMB
 74284 COMB
 74285 COMB
 74286 COMB
 74287 COMB
 74288 COMB
 74289 COMB
 74290 COMB
 74291 COMB
 74292 COMB
 74293 COMB
 74294 COMB
 74295 COMB
 74296 COMB
 74297 COMB
 74298 COMB
 74299 COMB
 74300 COMB

NOT USED
 "TAGS"
 NOT USED
 "TAGS"
 I/O DECODING
 INTERUPT DECODING
 INTERUPT CONDITION LATCH
 CONTROL PORT LATCH
 MOVING OBJECT SWITCH BUFFER LATCH
 OPTION SWITCH BUFFER
 AUDIO BOARD BUS BUFFER
 CONVERTER REGISTER BUFFER
 A/D CONVERTER LATCH
 SELECTABLE SWITCH DISPLAY
 50 Pence
 etc.

J1-N
 J1-M
 J1-P
 J1-Q
 J1-R
 J1-S
 J1-T
 J1-U
 J1-V
 J1-W
 J1-X
 J1-Y
 J1-Z

J2-10
 J2-9
 J2-8
 J2-7
 J2-6
 J2-5
 J2-4
 J2-3
 J2-2
 J2-1

J3-10
 J3-9
 J3-8
 J3-7
 J3-6
 J3-5
 J3-4
 J3-3
 J3-2
 J3-1

J4-10
 J4-9
 J4-8
 J4-7
 J4-6
 J4-5
 J4-4
 J4-3
 J4-2
 J4-1

J5-10
 J5-9
 J5-8
 J5-7
 J5-6
 J5-5
 J5-4
 J5-3
 J5-2
 J5-1

J6-10
 J6-9
 J6-8
 J6-7
 J6-6
 J6-5
 J6-4
 J6-3
 J6-2
 J6-1

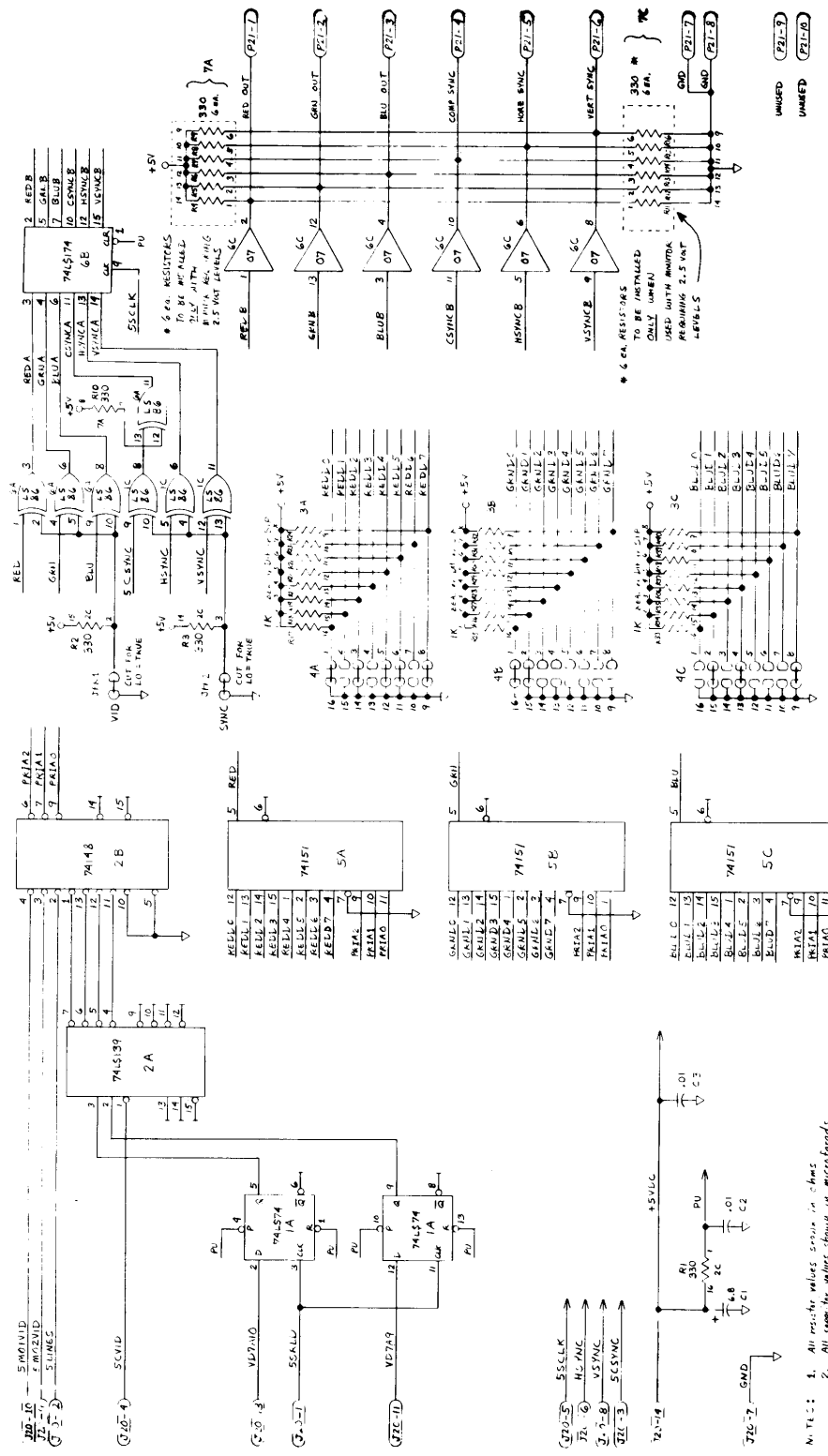

- NOTES:
1. All resistor values shown in Ohms
 2. All capacitor values shown in microfarads
 3. C4-C6 (not shown) are .01 microfarad disc. for bypass

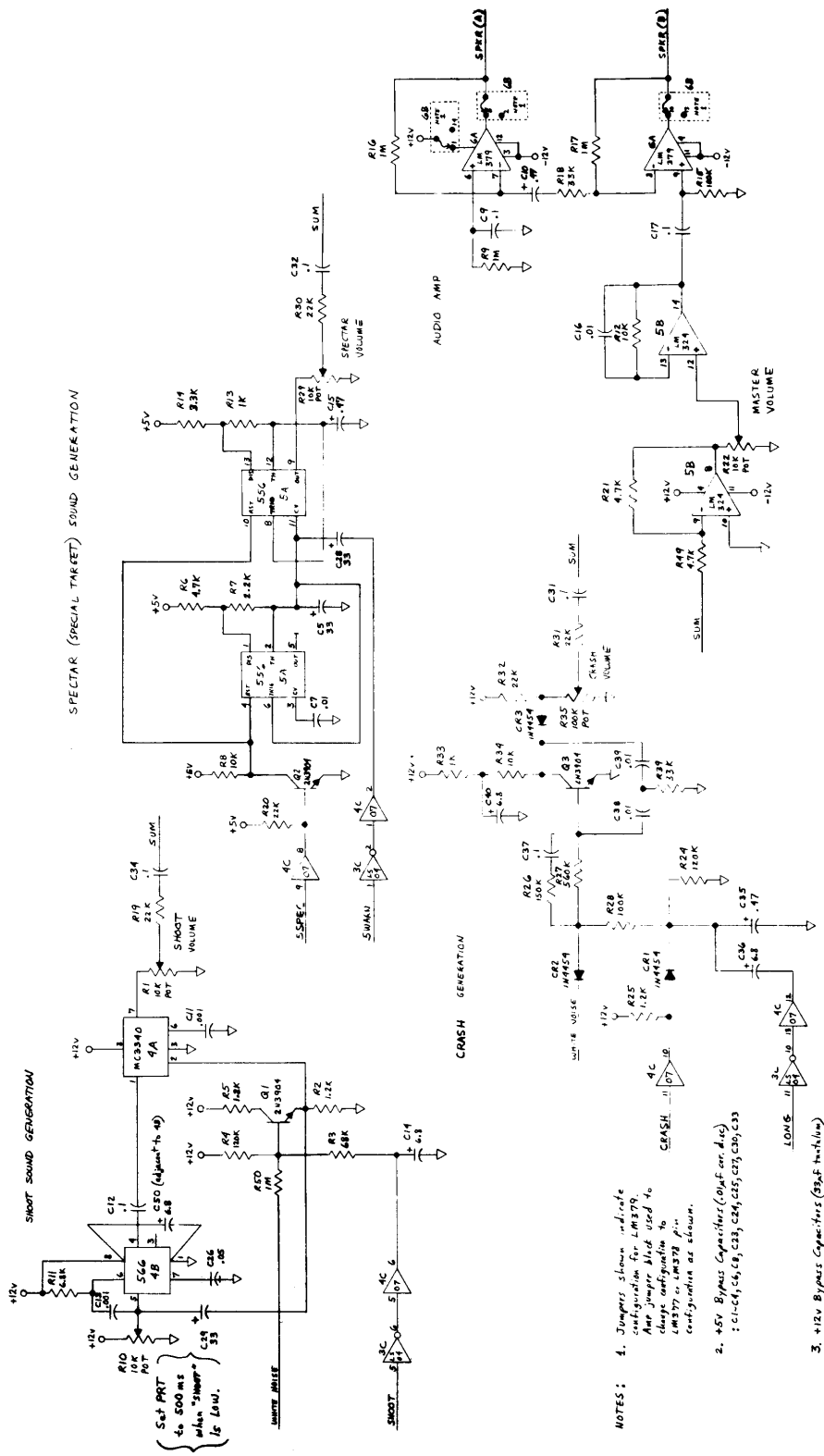

SPECTAR (SPECIAL TARGET) SOUND GENERATION

- NOTES:
1. Jumpers shown indicate configuration for LM379. An jumper block used to change configuration to LM377 or LM378 pin configuration as shown.
 2. +5V Bypass Capacitors (0.01µF or d.c.) : C1-C4, C6, C8, C33, C24, C25, C35, C30, C33
 3. +12V Bypass Capacitors (50µF or 100µF) : C19, C20

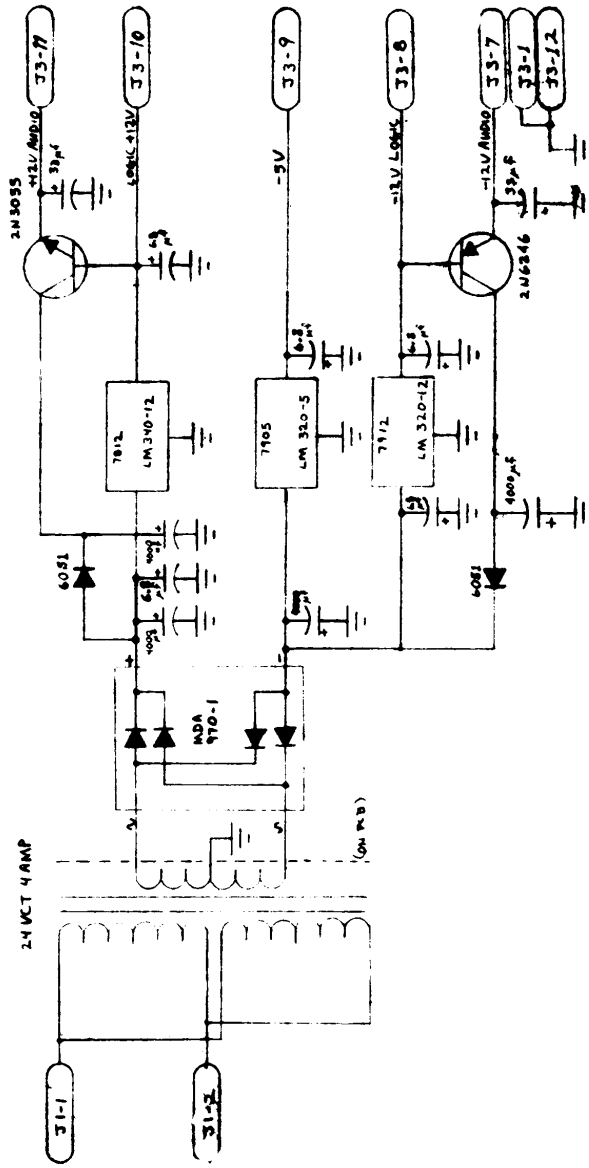

UNIVERSAL POWER SUPPLY SCHEMATIC
 +12.0 V Ambio & Logic, -12.0 V Ambio & Logic
 -5.0 V Logic

TARG
CONV HARNESS SCHEMATIC
(UNIVERSAL CONV HARNESS)

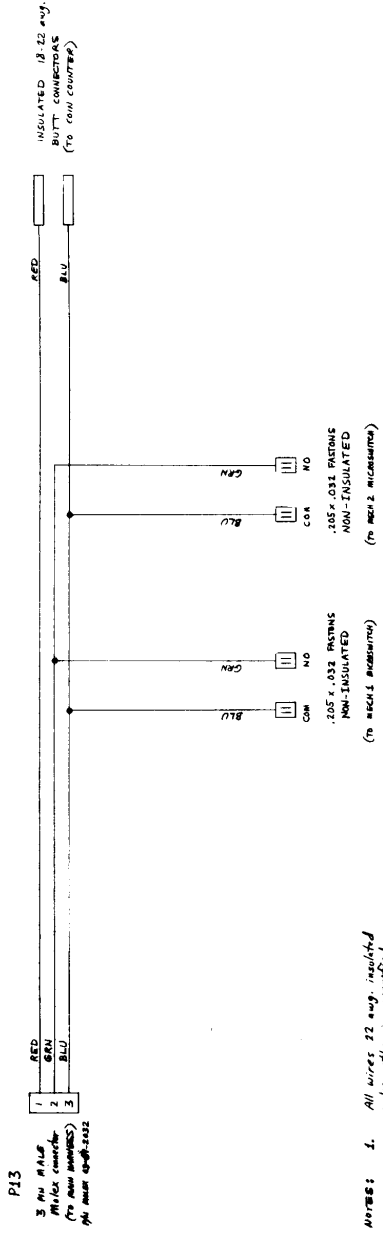

- NOTES: 1. All wires 22 awg. insulated unless otherwise specified.
2. ABSOLUTELY NO SUBSTITUTIONS ON SPECIFIED WIRE COLORS

TARG
CONTROL PANEL HARNESS
SCHEMATIC

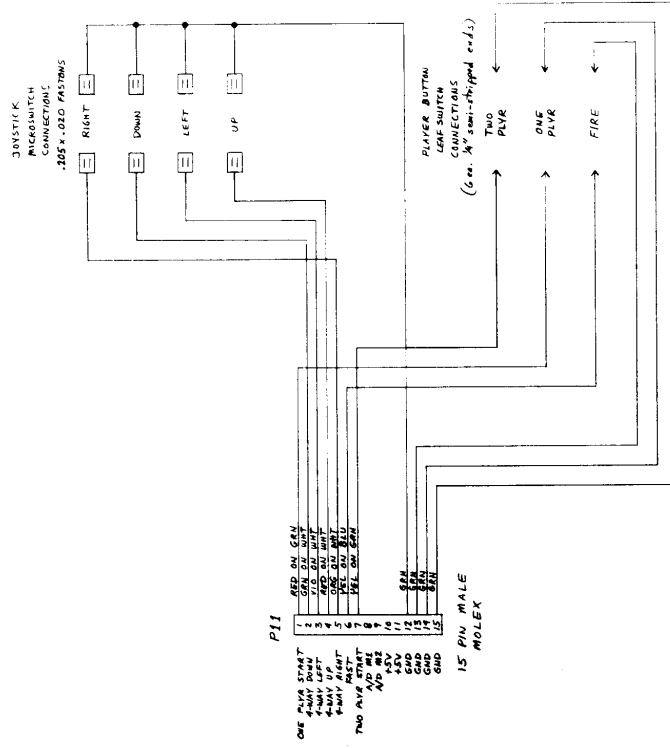

- NOTES:
1. All wires 22 awg. Insulated unless otherwise specified.
 2. ABSOLUTELY NO SUBSTITUTIONS ON SPECIFIED WIRE COLORS