

**VULGUS
CONVERSION KIT
INSTRUCTION
MANUAL**

SNK Electronics Corporation ***SNK***

3043 KASHIWA ST., TORRANCE, CALIFORNIA 90505

PHONE (213) 539-2744

TELEX: 182426



CONVERSION KIT CONTENTS:

- 1 - MAIN PRINTED CIRCUIT BOARD**
- 1 - P.C. BOARD CAGE (FCC REQUIRED)**
- 1 - CONNECTING WIRING HARNESS**
- 1 - 8-WAY JOYSTICK**
- 4 - FIRE BUTTONS**
- 1 - MARQUEE**
- 1 - MONITOR BEZEL OVERLAY**
- 1 - CONTROL PANEL OVERLAY**
- 1 - PLEX CONTROL COVER**
- 2 - SIDE STICKERS**
- 1 - PLAY INSTRUCTION & FUNCTION LABELS**
- 1 - TECHNICAL SERVICE MANUAL**

Note: Replacement Accessories Available Through Your Distributor...OR

SNK ELECTRONICS CORP.



TO THE TECHNICIAN

INTRODUCTION

This instruction manual has been specifically designed for your use. It will provide you with adequate information to convert your old game as simply as possible.

Contained herein are schematic diagrams for working with our printed circuit board. For better

understanding, a Main Block Diagram and a Sound Board Block Diagram are supplied.

Everything that you will need to construct your new game is provided in this kit, as listed on the preceding contents page.

CAUTION

F. C. C. REGULATION COMPLIANCE

THE P.C. BOARD CAGE SUPPLIED WITH THIS CONVERSION KIT MUST BE UTILIZED AND TERMINATED TO GROUND AT THE TIME OF INSTALLATION.

THIS IS TO AVOID RADIO FREQUENCY RADIATION AND COMPLY WITH THE LIMITS FOR A CLASS "A" COMPUTING DEVICE PURSUANT TO SUB-PART "J" OF PART 15 OF F.C.C. RULES, WHICH ARE DESIGNED TO PROVIDE REASONABLE PROTECTION AGAINST SUCH INTERFERENCE WHEN OPERATED IN A COMMERCIAL ENVIRONMENT.

OPERATION OF THIS EQUIPMENT IN A RESIDENTIAL AREA IS LIKELY TO CAUSE INTERFERENCE - IN WHICH CASE, THE USER AT HIS OWN EXPENSE, WILL BE REQUIRED TO TAKE WHATEVER MEASURES MAY BE REQUIRED TO CORRECT THE INTERFERENCE.

CONTROL PANEL LAYOUT

THE EIGHT WAY JOYSTICK SHOULD BE
CENTERED ON THE CONTROL PANEL AND THE
FIRE AND MISSILE BUTTONS PLACED AS
SHOWN BELOW:

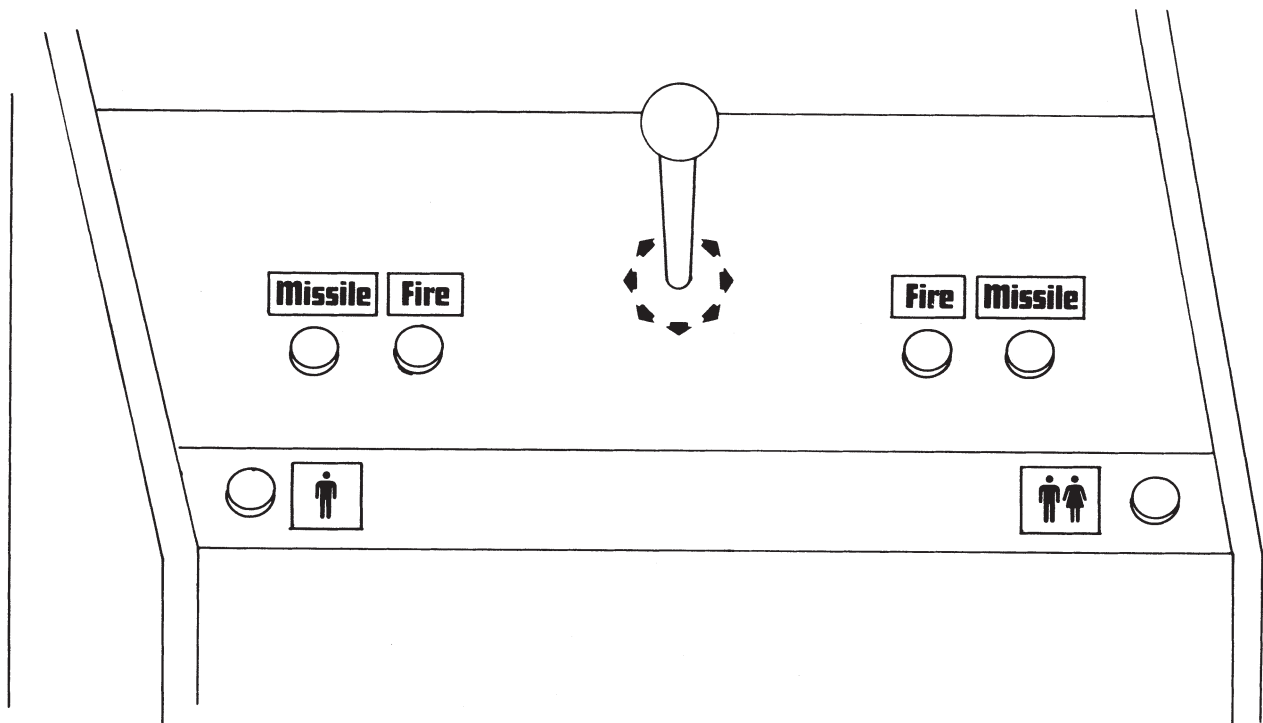

SW (A)

	CONTENTS	GAME DIP SW							
		1	2	3	4	5	6	7	8
GAME CHARGE (COIN-1)	1 COIN / 1 CREDIT	OFF	OFF	OFF					
	1 " / 2 "	ON	OFF	OFF					
	1 " / 3 "	OFF	ON	OFF					
	2 " / 1 "	ON	ON	OFF					
	3 " / 1 "	OFF	OFF	ON					
	4 " / 1 "	ON	OFF	ON					
	5 " / 1 "	OFF	ON	ON					
	FREE PLAY	ON	ON	ON					
GAME CHARGE (COIN-2)	1 COIN / 1 CREDIT				OFF	OFF	OFF		
	1 " / 2 "				ON	OFF	OFF		
	1 " / 3 "				OFF	ON	OFF		
	2 " / 1 "				ON	ON	OFF		
	3 " / 2 "				OFF	OFF	ON		
	4 " / 3 "				ON	OFF	ON		
	5 " / 4 "				OFF	ON	ON		
	FREE PLAY				ON	ON	ON		
NR. OF PLAYERS	3 AIR-PLANE							OFF	OFF
	1 "							ON	OFF
	2 "							OFF	ON
	5 "							ON	ON

SW (B)

	CONTENTS	GAME DIP SW							
		1	2	3	4	5	6	7	8
TYPE	TABLE TYPE	OFF							
	UP-RIGHT TYPE	ON							
BONUS POINTS	1st 20,000 2nd 60,000		OFF	OFF	OFF				
	" 10,000 " 50,000		ON	OFF	OFF				
	" 10,000 " 60,000		OFF	ON	OFF				
	" 10,000 " 70,000		ON	ON	OFF				
	" 20,000 " 70,000		OFF	OFF	ON			OFF	OFF
	" 20,000 " 80,000		ON	OFF	ON				
	" 30,000 " 70,000		OFF	ON	ON				
DEMO DEMO SOUND	DEMO WITH SOUND ON					OFF			
	DEMO WITH SOUND OFF					ON			
DEMO MUSIC SOUND	DEMO WITH MUSIC ON						OFF		
	DEMO WITH MUSIC OFF						ON		

CONNECTOR

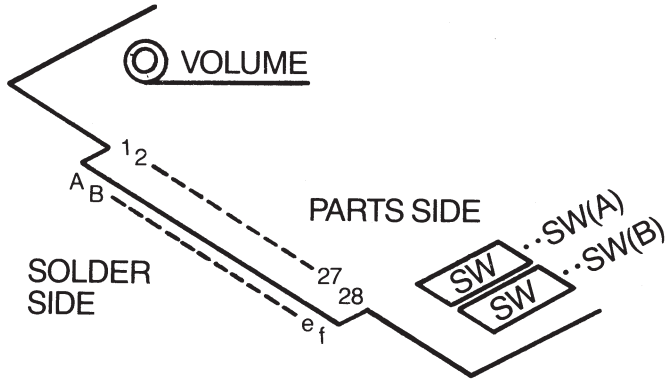

GND	A	1	GND		
+5V	B	2	+5V		
+12V	C	3	+12V		
GND (12V)	D	4	GND (12V)		
SPEAKER ⊖	E	5	SPEAKER ⊖		
SPEAKER ⊕	F	6	SPEAKER ⊕		
COIN COUNTER ⊖	H	7	COIN COUNTER ⊕		
		J	8		
1P {	SHOOT	K	9	UP SW	}
	DOWN SW	L	10	LEFT SW	
	RIGHT SW	M	11	(GND)	
2P {	SHOOT SW	N	12		}
	DOWN SW	P	13		
	RIGHT SW	R	14	(GND)	
	2P SW	S	15	(GND)	
	1P SW	T	16	(GND)	
	COIN SW (1)	U	17	(GND)	
	COIN SW (2) (SERVICE SW)	V	18	(GND)	
		W	19	1P CANNON	
		X	20	2P CANNON	
		Y	21	VIDEO GND	
VIDEO SIGNAL	Z	22	VIDEO (RED) OUTPUT		
VIDEO (GREEN) OUTPUT	a	23	VIDEO (GREEN) OUTPUT		
		b	24		
		c	25		
		d	26		
+5V	e	27	+5V		
GND	f	28	GND		

CPU (Z80A) MAIN CONTROL

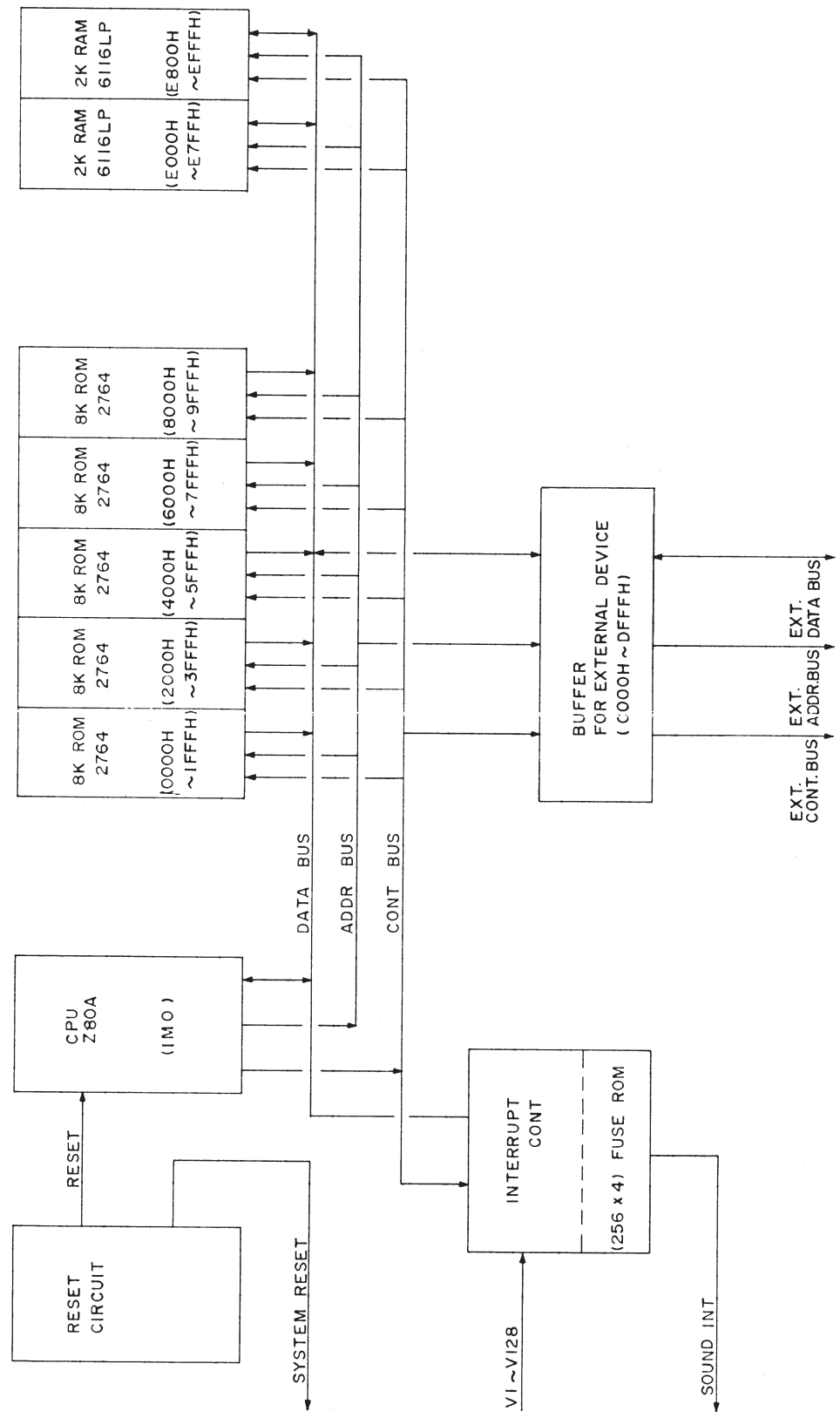

INPUT/OUTPUT

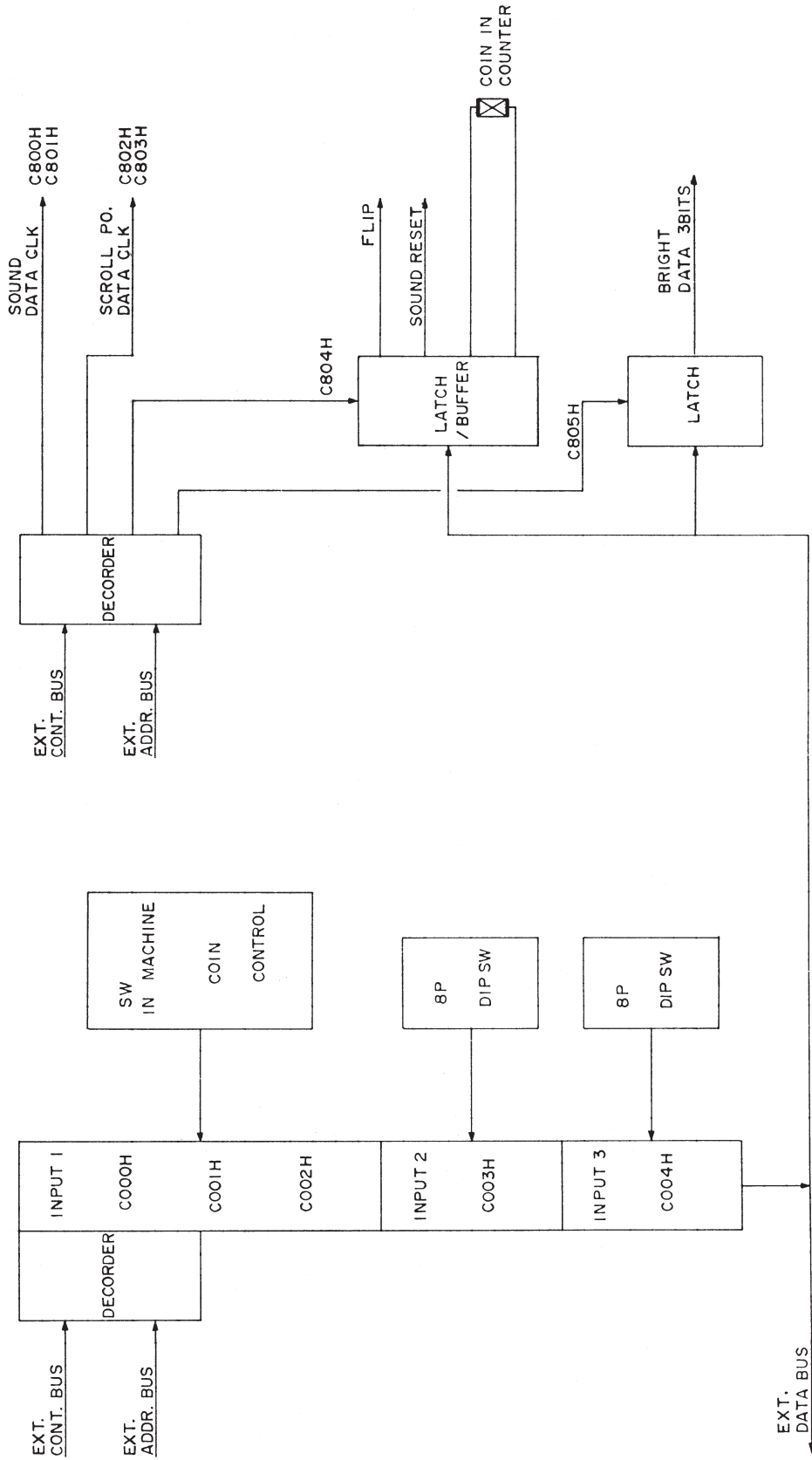

SOUND

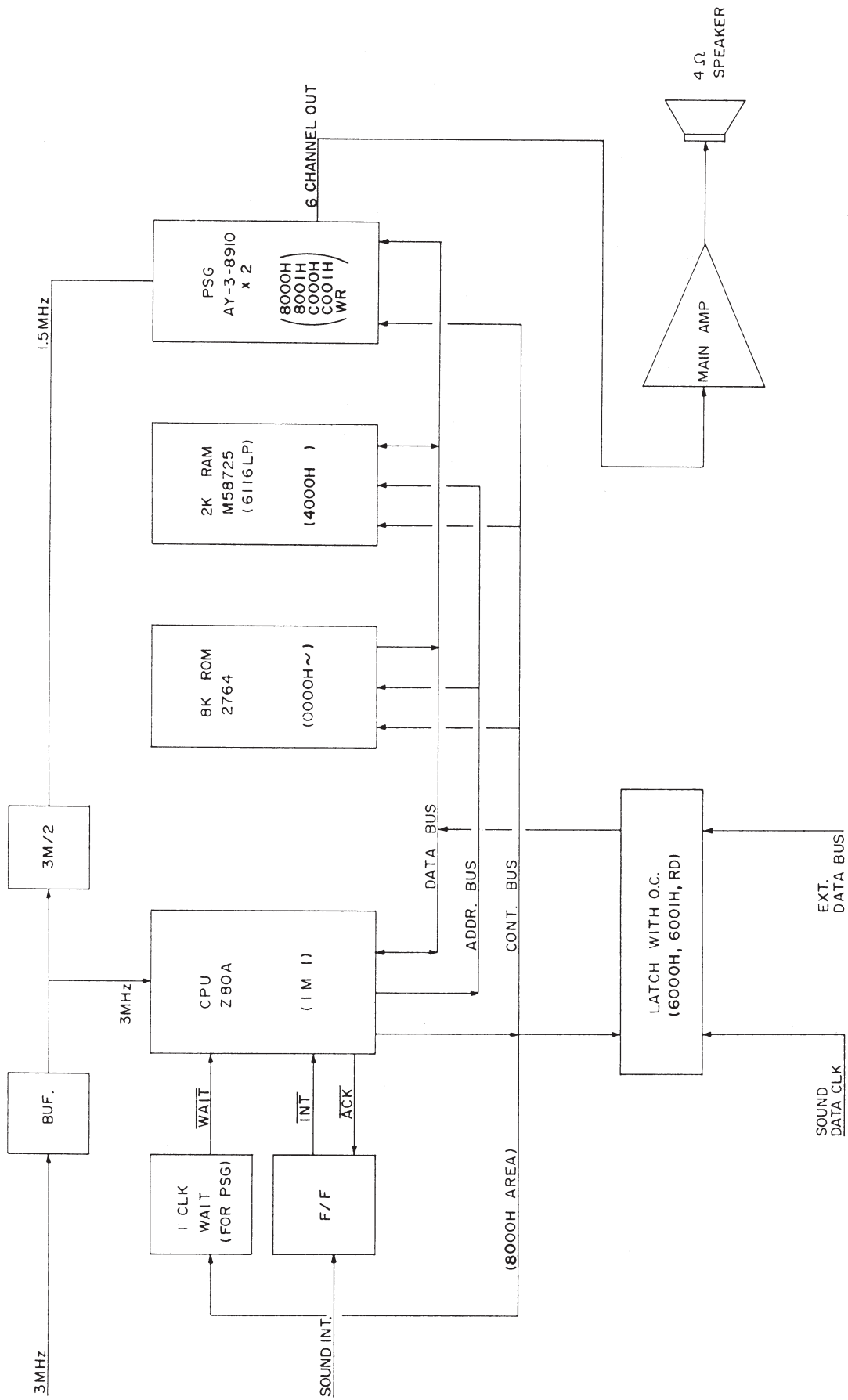

SYNCHRONOUS SIGNALS

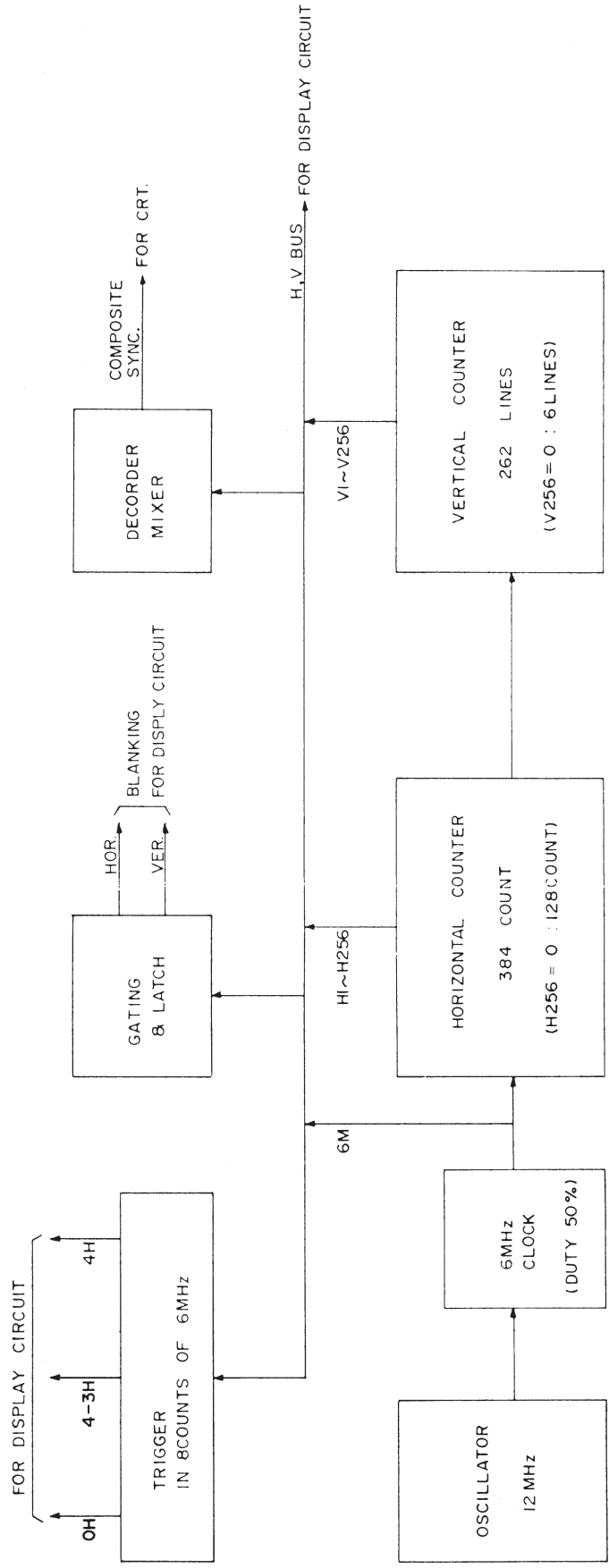
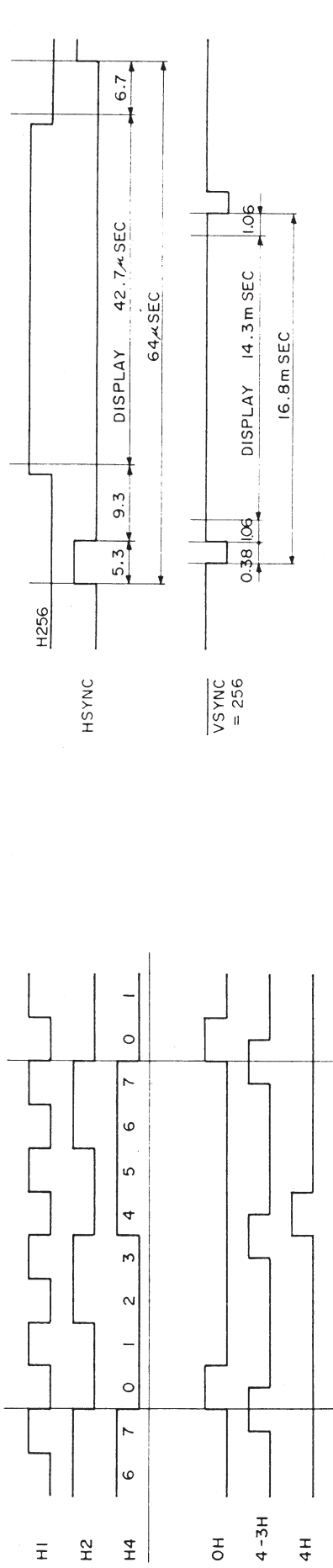

CHARA-GEN SECTION

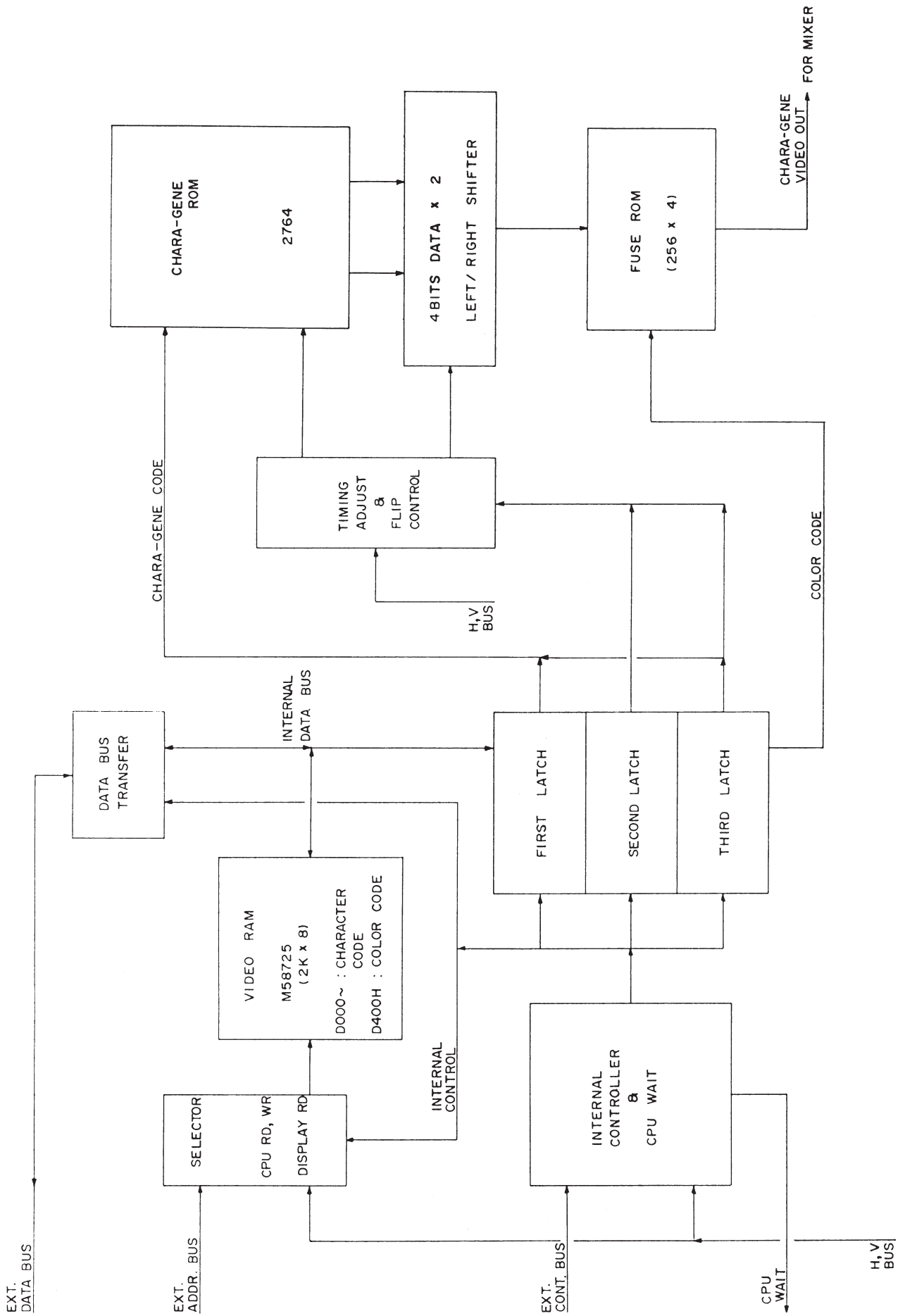

SCROLL VIDEO SECTION

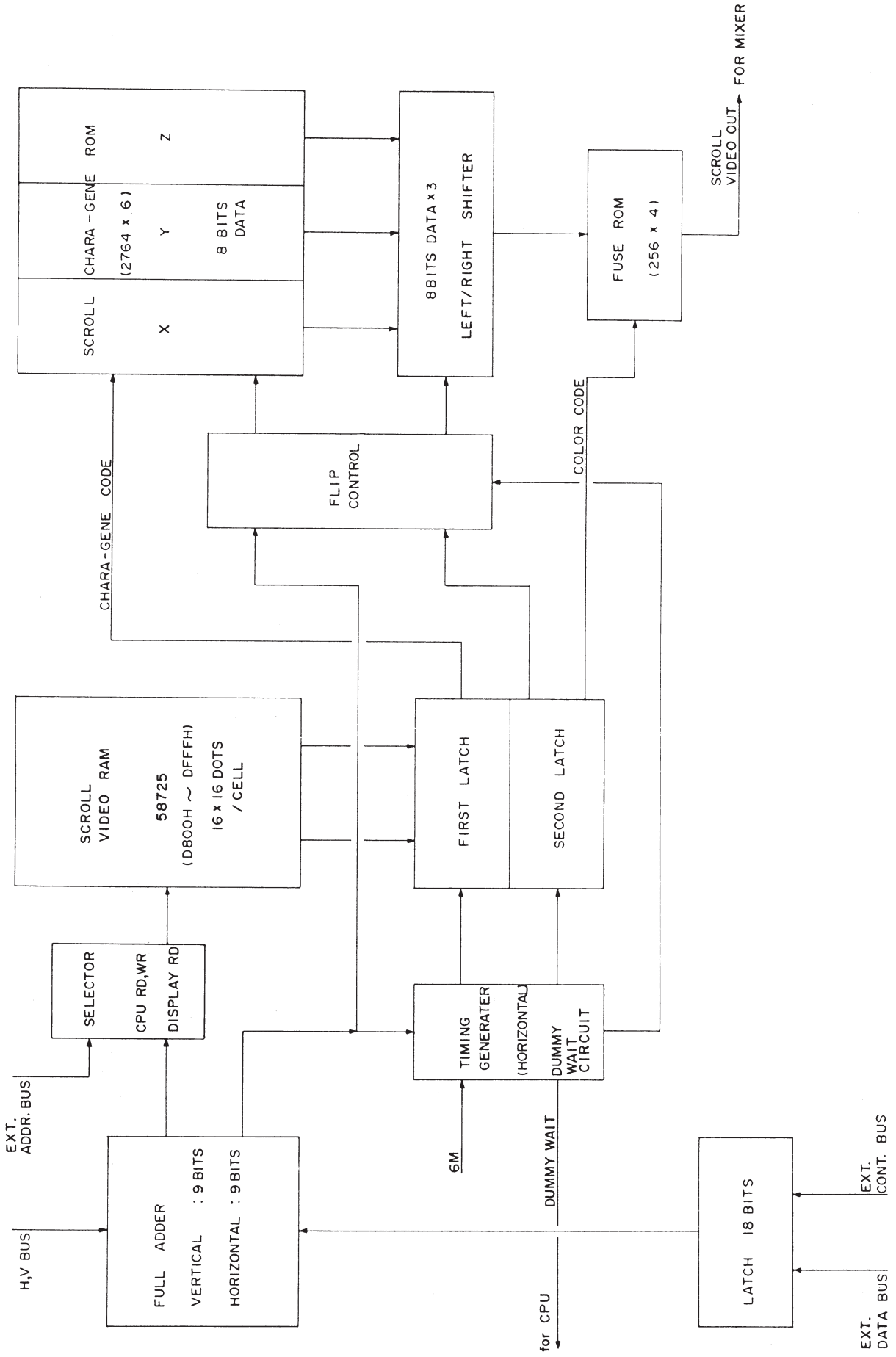

OBJECT VIDEO SECTION 1/2

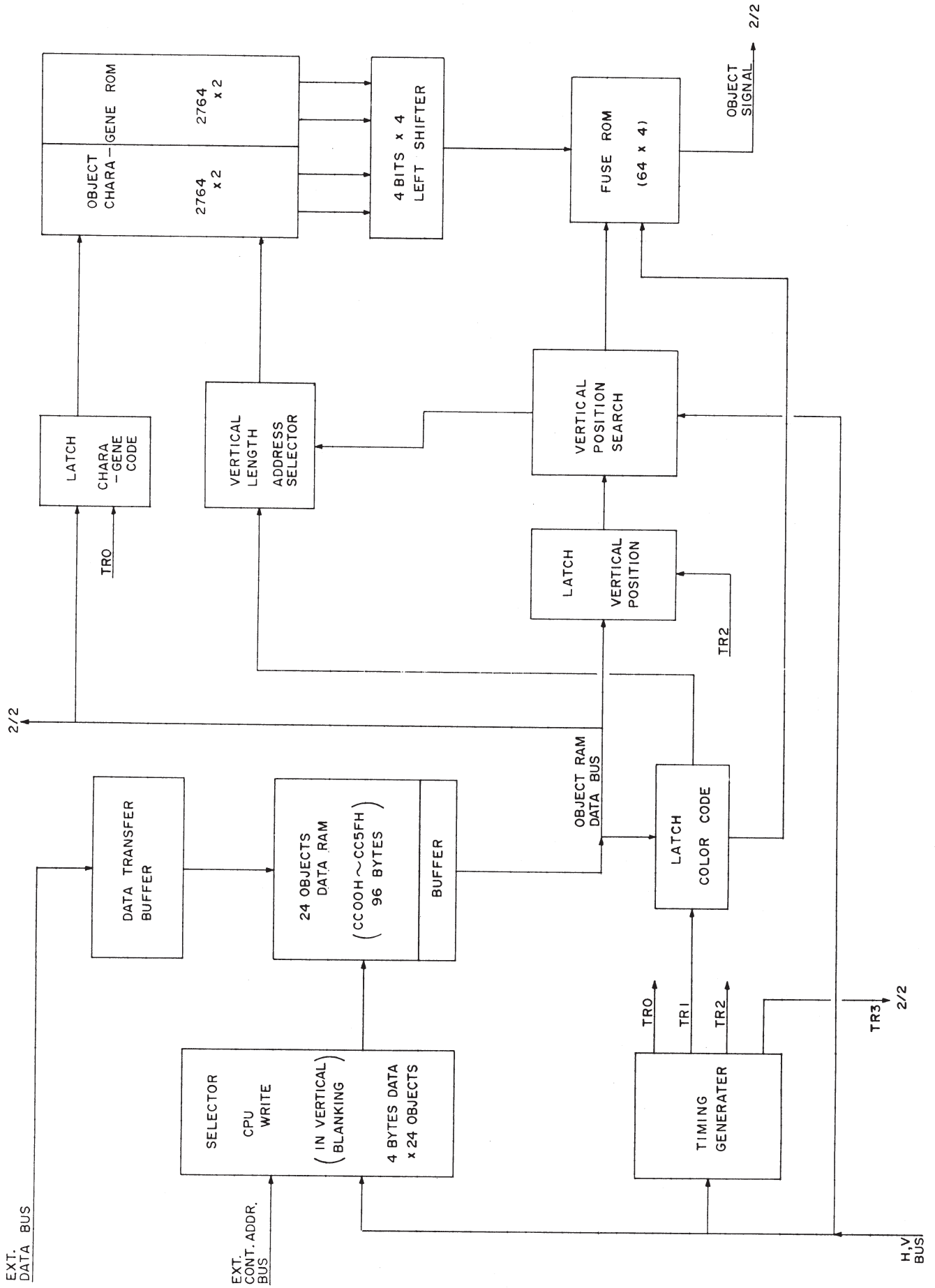

OBJECT VIDEO SECTION 2/2

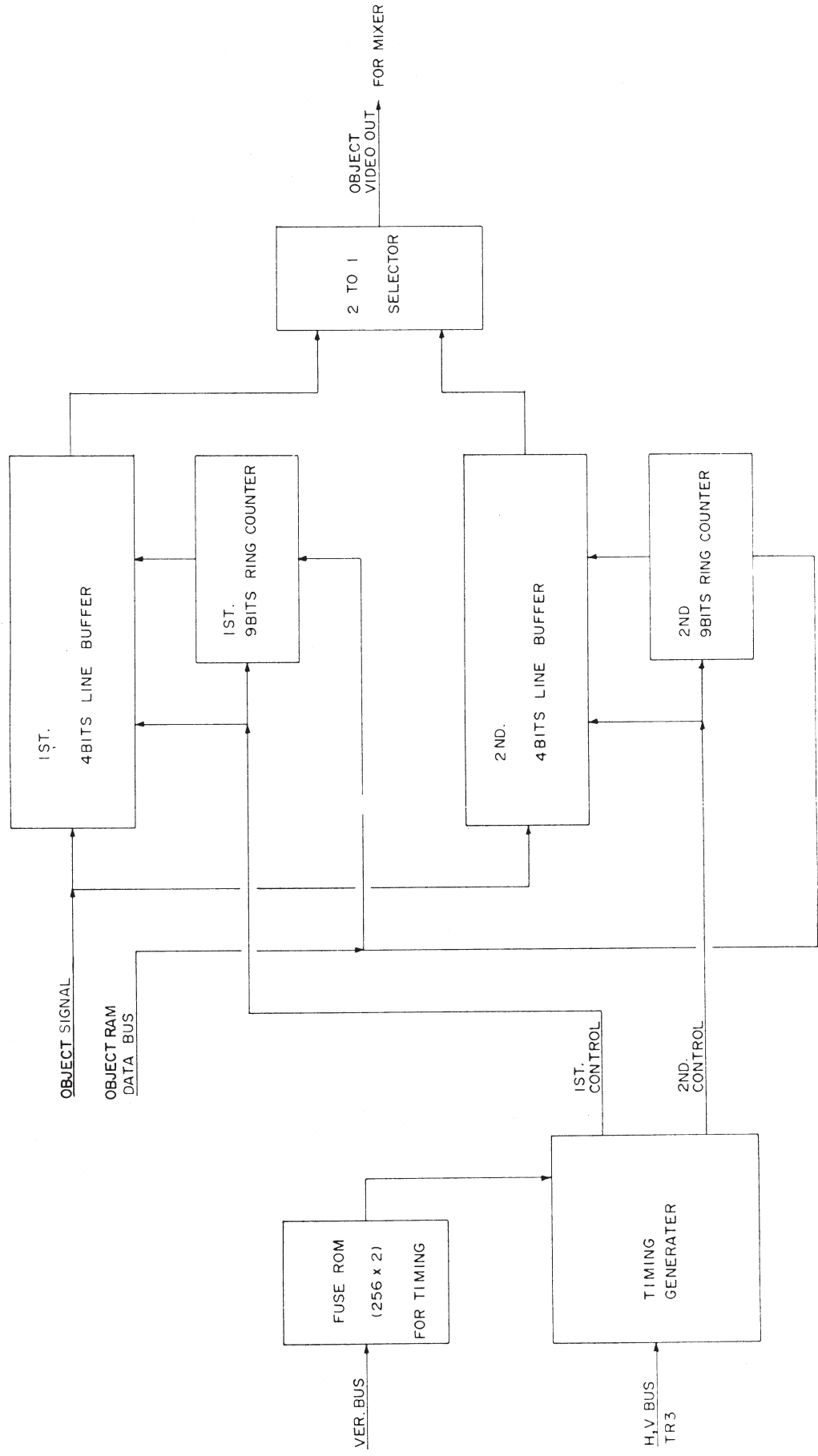

MIXER

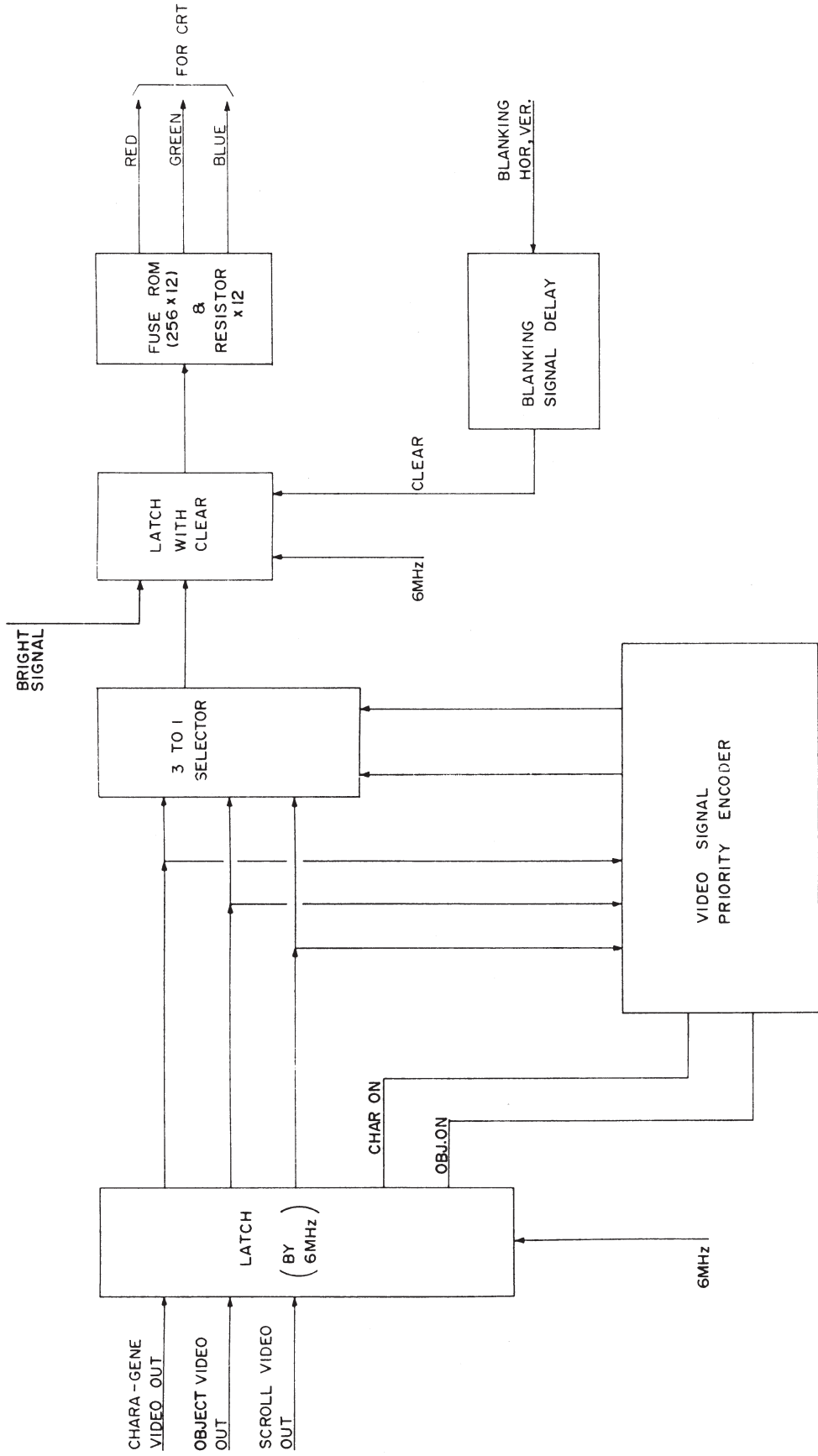

84602-01A-1

A B C D E F H J K L M N

C1
D1

A25
B25

CNI

AI
BI

CM2

C25
D25

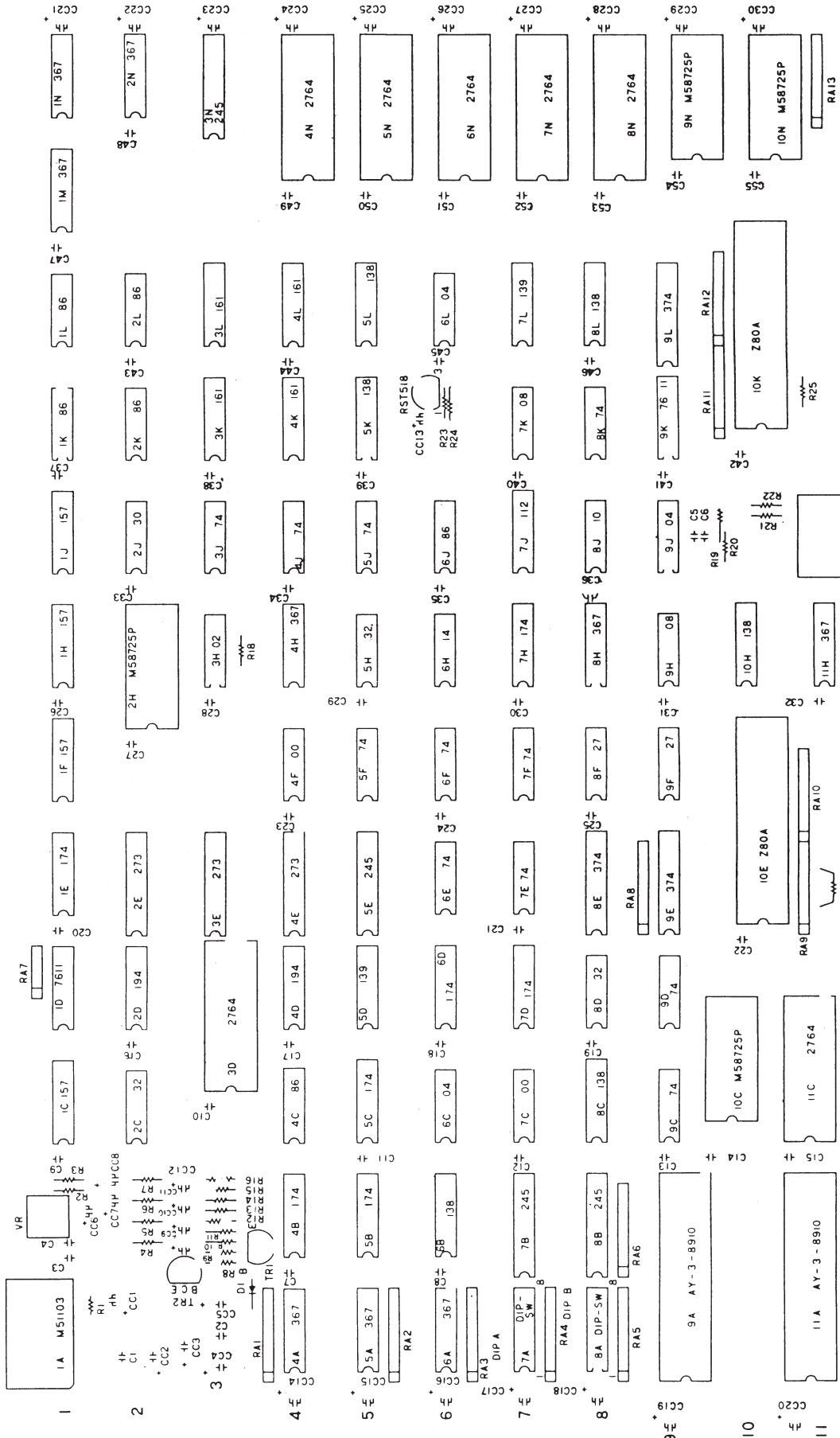

84602-02A

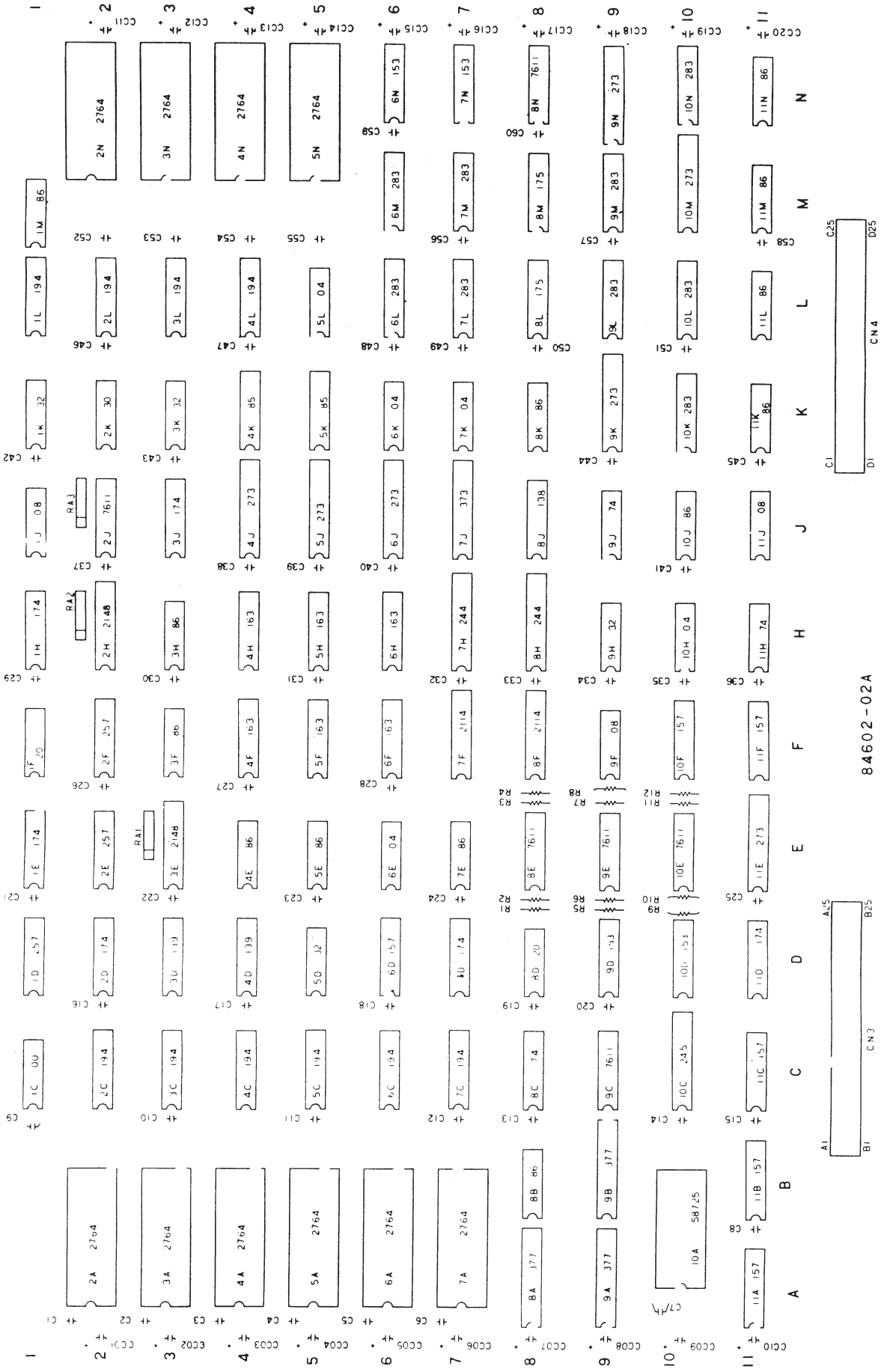

84602-02A

