



Space Tactics Shoots For High Profits

by Les Brown

On October 31, 1980 it began. The place was Chicago's Conrad Hilton Hotel. The event; the 32nd annual AMOA exposition. The pace was hectic and continuous. Over 100 booths containing game manufacturers' latest and best entertainment ideas, competed for attention. When the smoke had cleared one game had blasted its way to the foreground to capture RePlay magazine's acclaim as the "sit-down hit of the show." That game was Space Tactics, and it's now speeding its way to high profits for Gremlin/Sega customers.

The game is offered in cockpit and mini models and commands attention in any arcade. Space Tactics is a unique combination of computer and electro-mechanical assemblies. Its realistic "3-D" effect and multiple control panel attracts players at all skill levels. The challenge increases as wave after wave of invaders is destroyed. The player not only controls the defending ship, he is actually *inside* it, focusing and firing the searing laser at the enemy targets. Both the monitor and mirror in Space Tactics are mounted on rotating motors to give the game a realistic "in-flight" feeling.

Technicians will be pleased with Space Tactics' self-testing logic board making faulty RAMs easy to locate and replace. This feature also trouble-shoots switches and displays on the front panel.

Options selections include adjustments for the number of coins and credits to operate the coin mechanism, the number of defense barriers and bonus defense barriers, players' initials entry, and extended play feature. The game manual is thorough and will make trouble-shooting a breeze.

This is going to be a hot one, so climb aboard and hang on...Space Tactics is on the way!

Service School On The Road

The Gremlin/Sega Service School is on the road again. Over the next few months, Steve Margolin and Larry Tabler will be traveling to various cities throughout the U.S. and Canada.

Equipped with schematics and years of experience, they will bring technicians up-to-date on new products and provide effective techniques for troubleshooting them.

Margolin, Gremlin Customer Service Manager, sees the need for an organized, traveling service school. Many technicians in the field have good mechanical abilities, but are not trained in microprocessors and other electronic circuitry. It is an educational effort on our part to help reduce any downtime, and the customer frustration that usually accompanies it. A more informed technician is a better one, and the easier Gremlin can make it for him, the better our rapport with the customer.

Margolin sums up Gremlin's effort by saying, "Caring about your product goes well beyond just making a good game and selling it. After-sales services are necessary to continue 'reselling' Gremlin and its products to operators around the world."

If you would like to attend Gremlin's Service School, contact your local distributor for the date we will be in your area.

2—Data Bus

tech—tips

Installation Of Coin Switches

If you desire to install coin switches to replace the photo coin calculator in any of your games containing a dual VIC logic board, the following procedure details the proper installation.

Install coin switches in the proper location on the coin mechanisms as illustrated below in diagram C. Ensure that the activating wire is in the slot shown. The switch you install on the coin mechanism nearest the cash door hinge is considered switch 1.

If you wish to leave in the photo coin board, you can make use of the photo sensor mounted directly below coin mechanism 1. Cut all wires on connector to photo sensor below switch 1 except for the brown and violet wires. Remove connector from the other photo sensor and tuck out of way. As illustrated in diagram A, jumper the normally open terminals on the two switches together. Connect the brown wire from the photo sensor below switch 1 to one of the normally open terminals. Then jumper the common terminals together and connect to the violet wire from the same photo sensor mentioned above. The normally closed terminals are not used.

If the photo coin board is removed, the switches must be wired as shown in diagram B. Locate molex connector Pins 15, 16, and 17 on the main logic board. Run a wire from Pin 15 to the normally open terminal of switch 2 and jumper the normally open terminals of switch 1 and 2 together. Then run a wire from Pin 17 to the normally closed terminal of switch 1. The common terminal of switch 1 should be jumpered to the normally closed terminal of switch 2. And finally, run a wire from Pin 16 to the common terminal of switch 2.

Terminals on the coin switch are marked:

NC—Normally Closed

NO—Normally Open

C—Common

The Gremlin Part Number for coin switches is 510-0042.

If desired a slam switch, normally open kind, can be installed on the coin door and connected to TP2 and TP3 on the logic board.

DIAGRAM A

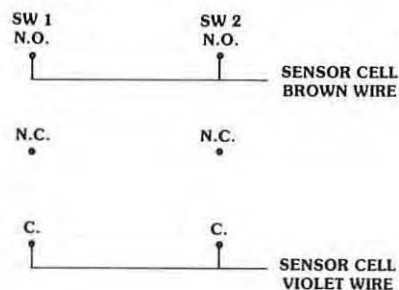

Diagram B

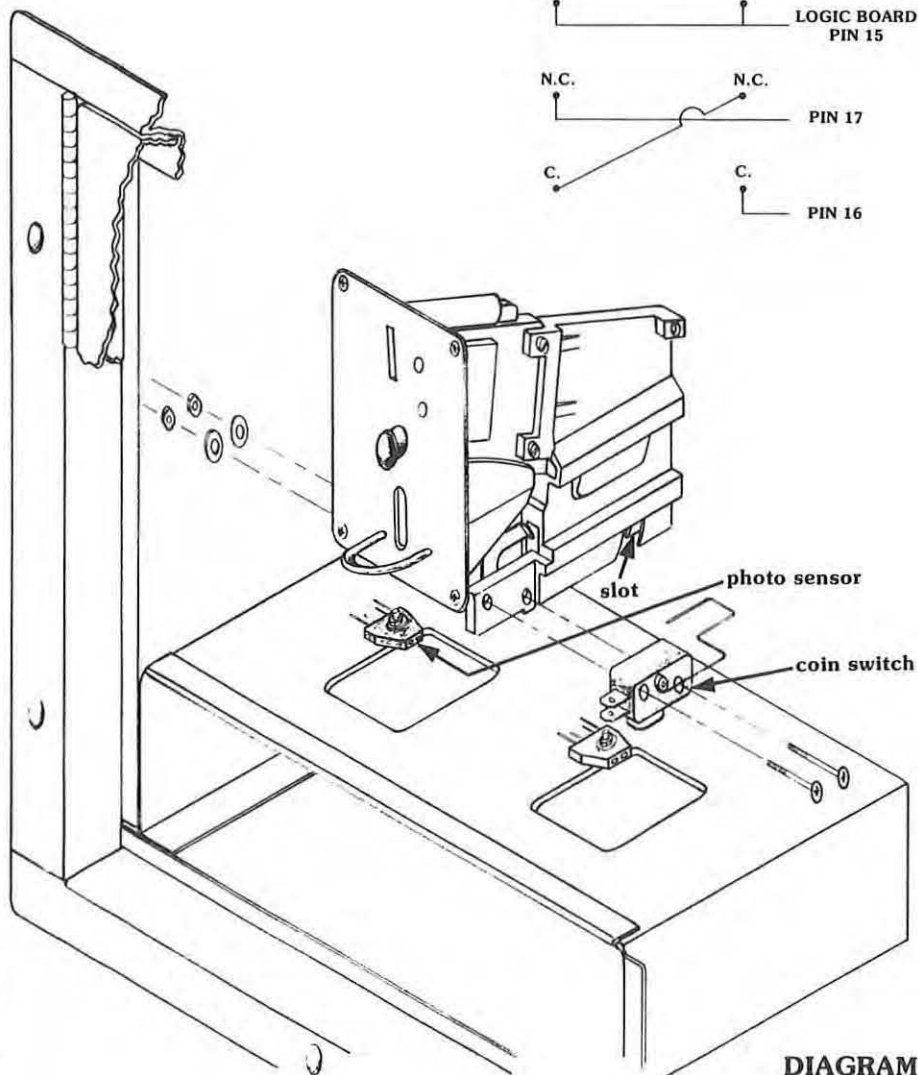
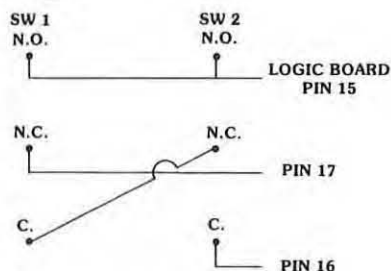

DIAGRAM C

service notes

ELECTROHOME MONITOR, 19"

When using a 19" electrohome monitor for a Gremlin-made Moon Cresta game, the yoke wires must be switched for proper connection. The yoke wire connector is located to the right of the yoke as viewed from the rear. See diagram at right. The yoke wires can easily be removed from the connector by using a small-blade screwdriver.

The proper wiring for a Gremlin-made Moon Cresta is:

Configuration A

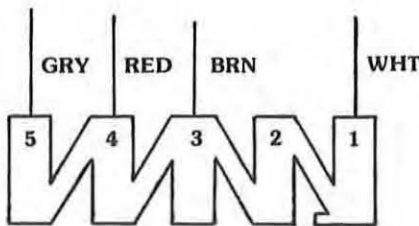

The proper wiring for a Sega-made Moon Cresta or Space Firebird is:

Configuration B

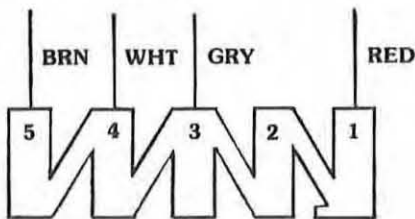

When testing Moon Cresta Logic Boards from a Sega-made game on your Moon Cresta Test Kit, the yoke in the test kit monitor must be wired as shown in Configuration B. Re-wire the yoke wires as per Configuration A when testing Gremlin-made Moon Cresta Logic Boards. If you have any questions regarding this service note, contact Gremlin/Sega customer service, (714) 277-8700.

Space Firebird 001

The recently released Space Firebird Owner's Manual, 420-0533, contains errors on CPU Schematic (834-0031), Video Schematic (834-0030), and the Programmable Sound Board Schematic (834-0026). The following changes should be made:

CPU Schematic

1. Change sheet 2 of 3 to read 1 of 2.
2. Change sheet 3 of 3 to read 2 of 2.

sheet 1

1. In Quadrant 7B, the LS04 next to IC 3M is 3F not 3E.
2. IC 1F, Pin 2 goes to 1C, Pin 11 not to R18.
3. Connector P7, Pin 1 should be +5V not +24V. (Counter voltage should be less than +5V)
4. In Quadrant 4D, change SYNC to read COMP SYNC.

sheet 2

1. The Inverter Gate leading to IC 3G, Pin 11 should be labeled 3F.
2. IC 5D, Pin 15 goes to 3B, Pin 6.
3. Connector P1, positions 1 through 8 should be listed as:
 - 1—Bomb Sound
 - 2—Firebird Hit
 - 3—Bonus (1000)
 - 4—Hyper Space
 - 5—Bird Falling
 - 6—Laser
 - 7—Bird Hit
 - 8—Explosion
4. Write Gremlin numbers on the Eproms (2716 X 8), left to right:
 - C39—767
 - C40—768
 - C41—769
 - C42—770
 - C43—771
 - C44—772
 - C45—773
 - C46—774

Video Schematic

1. Change sheet 2 of 3 to read 1 of 2.
2. Change sheet 3 of 3 to read 2 of 2.

sheet 1

1. IC 2E should be LS86 Vice LS66.
2. In Quadrant 3B, delete C38—if this capacitor is on your Board, you will not be able to see the laser fire on the screen.
3. Label the Eproms at positions 5K and 6K as: 5K—775, 6K—776.

sheet 2

1. In IC 5B, 6B, 5C, 5D, 6D, 5E, and 6E change 22PIC to read 21001A-2.

Sound Board Schematic

1. In Quadrant D5, IC 12, Pin 13 goes to IC 9, Pin 4 not Pin 6.
2. Connector P2 should be labeled as:
 - 5—Bird Falling
 - 3—Bonus (1000)
 - 4—Hyper Space
 - 2—Firebird Hit
 - 1—Bomb Sound
 - 6—Laser
 - 7—Bird Hit
 - 8—Explosion
3. On connector P3, label Pin 13 as "Explosion Noise".
4. In Quadrant 7B, label VR2 as "Laser Sound Adjust".
5. In Quadrant 6A, C21 should be C18.
6. In Quadrant 5B, label VR3 as "Bird Hit Adjust".
7. In Quadrant 6D, label the point under Anode D2 as "Noise For Laser".
8. In Quadrant 7C, label IC 20 as 775.
9. In Quadrant 5B, the line after R42 should be labeled "Explosion Noise Out".
10. In Quadrant C4, the line after R13 should be labeled "Laser And Bird Hit Out".

4—Data Bus

the ROM line

Clock Circuits

In this installment of the ROM Line, we will discuss typical clock circuits in microprocessor-based games.

As you remember, a computer requires a master timing signal to keep all its actions occurring at the right time and place. For example, an accurate and stable clock times the occurrence of the "memory read" and "memory write" signals from the microprocessor. Obviously, these 2 signals must occur at *different* times; if they occurred together, mass confusion would result.

A typical clock circuit is shown in Figure 1, below.

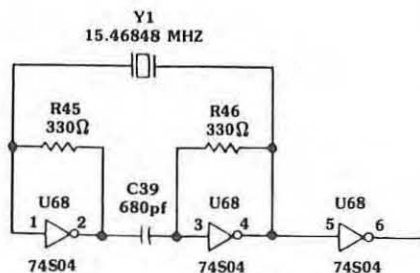

Figure 1

Note that it contains a crystal, Y1; this is because the signal generated by a crystal is more stable than that from other types of oscillators. The crystal's signal is amplified by the inverter IC to a level that is capable of driving the microprocessor.

In circuits containing the Z80 microprocessor, there is only one clock input needed and is designated by the symbol Φ . In servicing video game boards, checking for this signal is one of the most important steps toward repair. This signal *must* be present, and must be of sufficient voltage, to operate the microprocessor.

Let's look closer at timing signals and see their importance. A computer works in a series of steps, which form the computer program. The point to

remember in understanding the computer's operation is that these steps are acted on in a precise order. Figure 2 shows the Z80 processor timing diagrams for a memory read and memory write.

The " Φ " symbol refers to the master clock signal, as discussed above. Note how all the other timing signals occur in relation to this master signal. The next signal, A0-A15, represents the memory address selection on the Z80's 16 address lines. Since the address lines can be either hi or lo, the timing signal indicates this with 2 lines:



Once the memory address has been selected, the next signal, MREQ (Memory Request), goes lo to indicate that the address is valid. Then, the RD (READ) signal goes lo to activate the memory circuit and force the stored information onto the data bus. Notice

that the WR (WRITE) signal is inactive during this time.

Finally, the data bus signal shows that during the end of the MREQ and RD signals, the stored information has been placed on the data bus and can now be read by the Z80 and acted upon. The signals occur in the same sequence for a memory write, as shown, except that the READ signal remains inactive during this time. The signal labelled "WAIT" is used to coordinate the flow of information from memory and input/output devices to the Z80. The WAIT line forces the Z80 to "wait" for a data transfer from these sources.

In this article, we have seen the importance of the clock signal in all computer systems. It is this signal that keeps all computer events occurring at the right time and place. In the next issue of DATA BUS, we'll learn about the I/O ports in a computer.

MEMORY READ OR WRITE CYCLES

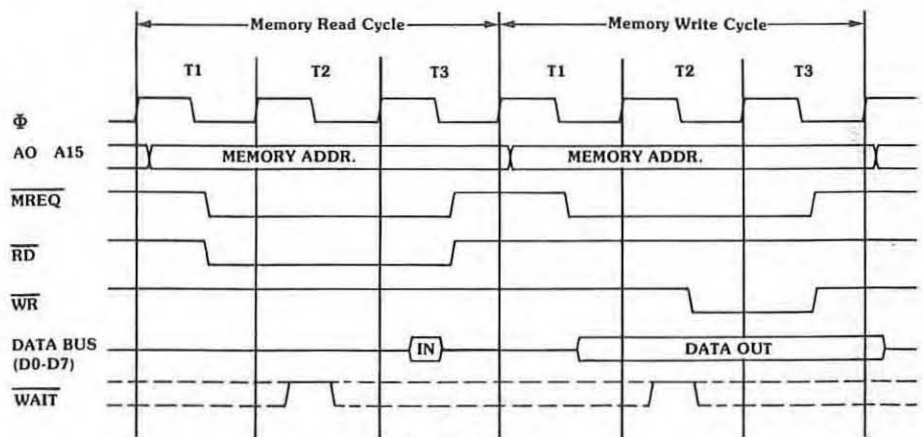

Figure 2

Data Bus is a service newsletter published by Gremlin/Sega Customer Service, 8401 Aero Drive, San Diego, California 92123.

Parts Order—(714) 277-8700

Technical Assistance—800-854-1098

TLX—910-355-1621

Editor—Richard Cortez