

**MIDWAY MFG. CO.**

A BALLY COMPANY

10750 W. GRAND AVENUE • FRANKLIN PARK, ILL. 60131

PHONE: AREA CODE 312 451-1360

CHICAGO PHONE: 992-2250

## TABLE OF CONTENTS

	Page No.		Page No.
SELF TESTING RAMS & ROMS	1	GALAXIAN INTERFACE WIRE SEQUENCE	46—50
RAMS & PROM CHART	2	WELLS GARDNER INTERFACE WIRE SEQUENCE	51
GAME NUMBERS	3—6	ELECTROHOME INTERFACE WIRE SEQUENCE	52
DIFFERENT POWER SUPPLIES	7	GALAXIAN WELLS GARDNER 19K 4500	53
ANTI-PENNY KIT	8—9	GALAXIAN 25 INCH MONITOR	54—55
ANTI-STRING KIT	10	GALAXIAN BLACK & WHITE MODIFICATION	56
WIZARD OF WOR FEATURES	11	EXTRA BASES BALL SENSOR MODIFICATION	57
RALLY X RAM CODE	12—13	EXTRA BASES RAM CARDS	58
GORF CARD RACK SYSTEM	14	DELUXE SPACE INVADERS NAME FEATURES	59
GORF PROGRAM CHANGE	15—17	SPACE INVADERS DELUXE CUSTOM I.C.	60
SPECIAL ALLEN WRENCH	18	SPACE INVADERS DELUXE PROM & ROMS	61
ANTI-STATIC CLEANER	19	PROM & ROM IDENTIFICATION	62
NEW BACK DOOR KEY	20	SPACE INVADERS RANDOM GARBAGE	63—64
CREDIT BYPASS JACK	21	SPACE INVADERS LINES IN VIDEO	65
COLOR MONITOR BRIGHTNESS ADJUSTMENT	22	SPACE INVADERS DIP SWITCH SETTING	66
PAC-MAN CUSTOM CHIP	23	SPACE INVADERS 25S10 & 74151 CHIPS	67
PAC-MAN DIP SWITCHES	24	SUBMARINE ZERO SWITCHES	68
PAC-MAN ROM & RAM TEST CODE	25	18 WHEELER PREMATURE GAME OVER	69
CARD RACK SYSTEM TEST CARDS	26	18 WHEELER BACK DOOR VENTING	70—71
SPACE ENCOUNTER STROBE UNIT FIX	27—28	ELECTROHOME G0-2 COLOR MONITOR	72
SPACE ENCOUNTER TRIGGER KIT	29—30	CUSTOM CHIPS	73
SPACE ENCOUNTER GAME BOARDS	31	SEA WOLF II ELECTROHOME MONITOR	74
SPACE ENCOUNTERS 25K POTS	32—33	ROTATION VIII POWER RESET	75—76
SPACE ENCOUNTERS POWER SUPPLY	34	ROTATION VIII "F" & "G" BOARD	77
GALAXIAN COIN SWITCH CAPACITOR	35	RAM & ROM SELF TEST BOWLING ALLEY	78—79
GALAXIAN AND PAC-MAN STATIC KIT	36—37	STRAPPING 2716 & 9316	80
GALAXIAN RAM & ROM TEST	38	PROM STRAPPING SINGLE SUPPLY	81
GALAXIAN PROGRAM #1 & #2	39	POWER SUPPLY CHECK LIST	82
GALAXIAN PROGRAM #3	40	MOTHER BOARD RESET FIX	83
GALAXIAN ALTERNATE P.C. BOARD	41	MONITOR YOKE WIRING	84—85
GALAXIAN BAD RAM #2	42	MONITOR MANUFACTURERS	86
VIDEO GAME MONITORS	43	GLOSSARY OF TERMS	87
ELECTROHOME COLOR ADJUSTMENT	44—45		



**MIDWAY MFG. CO.**

A BALLY COMPANY

10750 W. GRAND AVENUE • FRANKLIN PARK, ILL. 60131

PHONE: AREA CODE 312 451-1360

CHICAGO PHONE: 992-2250

## SERVICE BULLETIN

### Roms and Rams Self Testing

GAME	SELF TEST SWITCH
Gun Fight	None
Sea Wolf	Roms only Switches 6, 7, & 8 to off position
Tornado Baseball	Switch #6 off
Maze	Switch #4 off
280ZZap	Switch #3 off & #4 on
Check Mate	Switch #8 off
Boot Hill	Switch #5 off
Double Play	Switch #7 on
Road Runner	Switch #7 & #8 off
Guided Missile	Switch #8 on
Laguna Racer	Switch #7 off & #8 on
M-4	Switch #5 on
Clowns	Switch #8 off
Extra Inning	Switch #7 on
Sea Wolf II	Switch #8 off
Space Walk	Switch #8 off
Dog Patch	Switch #6 on
Shuffleboard	Switch #8 on
Bowling Alley	Switch #8 on
18 Wheeler	Switch #8 on
Phantom II	Switch #6 off
Super Speed Race	Switch #8 off
Space Invaders II	Switch #8 off
Galaxian, Pac-Man & Rally X	Slide Switch on
Space Encounters	Switch #5 off & #6 on
Space Zap, Gorf & Wizard Of WOR	Slide Switch on

NOTE: Activate coin door tilt switch to start self test.  
Invaders & Blue Shark has no Ram and Rom Test.

**ROM & PROM CHART**

	<b>GAME</b>	<b>4K</b>		<b>8K</b>		<b>16K</b>
	GUN FIGHT	8	(3604)	4	(1976)	NO
	SEA WOLF	8	(3604)	4	(27581)	2 (9316)
	TORNADO BASEBALL	NO		NO		3 (9216)
	MAZE	8	(3604)	4	(2708)	2 (9316)
	280 ZZZAP	NO		6	(2708)	3 (9316)
	CHECKMATE	8	(3604)	4	(2708)	2 (9216)
	BOOT HILL	NO		NO		4 (9316)
	DOUBLE PLAY	NO		8	(2708)	4 (9316)
	ROAD RUNNER	NO		8	(2708)	4 (9316)
	GUIDED MISSILE	NO		8	(2708)	4 (9316)
	LAGUNA RACER	NO		7	(2708)	4 (9316)
	M-4	NO		8	(2708)	4 (9316)
	CLOWNS	NO		6	(2708)	NO
(2X)	EXTRA INNING	NO		NO		5 (2716)
	SEA WOLF II	NO		NO		4 (2716) (9316)
	SPACE WALK	NO		8	(2708)	NO
(2X)	DOG PATCH	NO		NO		4 (2716)
(2X)	SHUFFLEBOARD	NO		NO		4 (2716)
	ROTATION VIII	NO		NO		4 (2716)
(2X)	SPACE INVADER	NO		NO		4 (2716) (9316)
(2X)	BOWLING ALLEY	NO		NO		5 (2716)
(2X)	BLUE SHARK	NO		NO		3 (2716)
(Z80)	18 WHEELER	NO		NO		4
(2XL)	PHANTOM II	NO		NO		4+1 (2716)
(Z80)	SUPER SPEED RACE	NO		3		2 (2716)
(Z80)	SUBMARINE	NO		3		2 (2716)
(2XL)	SPACE INVADERS DELUXE	NO		NO		5 (2716) (9316)
(2XL)	SPACE INVADERS II	NO		NO		6 (2716)
(NAMCO)	GALAXIAN	NO		NO		7 (2716) (9316)

---

	<b>GAME</b>	<b>8K</b>	<b>16K</b>	<b>32K</b>
	EXTRA BASES	NO	8	4
	SPACE ENCOUNTERS	NO	8	NO
	SPACE ZAP	NO	8	4
	GORF	NO	16	8
	PAC-MAN	NO	NO	6
	RALLY X	NO	NO	5
	Wizard Of WOR	NO	NO	7



**MIDWAY MFG. CO.**

A BALLY COMPANY

10750 W. GRAND AVENUE • FRANKLIN PARK, ILL. 60131

PHONE: AREA CODE 312 451-1360

CHICAGO PHONE: 992-2250

### SERVICE BULLETIN

GAME (UPRIGHT)	DATE	GAME NUMBER
GUN FIGHT	1975	597
SEAWOLF	1976	596
TOP GUN	1976	603
TORNADO BASEBALL	1976	605
280 ZAP	1976	610
MAZE	1976	611
BOOT HILL	1977	612
CHECKMATE	1977	615
ROAD RUNNER DESERT GUN	1977	618
DOUBLE PLAY	1977	619
LAGUNA RACER	1977	622
GUIDED MISSILE	1977	623
M-4	1977	626
SEAWOLF II	1978	625
CLOWNS	1978	630
SPACE WALK	1978	640
EXTRA INNING	1978	642
SHUFFLEBOARD	1978	643
DOG PATCH	1978	644

BOWLING ALLEY	1979	730
SPACE INVADERS	1979	739
PHANTOM II	1979	652
18 WHEELER	1979	653
SUBMARINE	1979	760
SUPER SPEED RACE	1979	762
EXTRA BASES	1980	761
SPACE ENCOUNTERS	1980	645
SPACE INVADERS II	1980	851
SPACE INVADERS DELUXE	1980	852
BLUE SHARK	1980	742
GALAXIAN	1980	866
SPACE ZAP	1980	902
PAC-MAN	1980	932
GORF	1981	873
RALLY X	1981	935
WIZARD OF WOR	1981	961

ANDY DUCAY  
SERVICE MANAGER

AD/dd



**MIDWAY MFG. CO.**

A BALLY COMPANY

10750 W. GRAND AVENUE • FRANKLIN PARK, ILL. 60131

PHONE: AREA CODE 312 451-1360

CHICAGO PHONE: 992-2250

**SERVICE BULLETIN**

<b>GAME (TABLE)</b>	<b>DATE</b>	<b>GAME NUMBER</b>
GUN FIGHT	1975	604
TORNADO BASEBALL	1976	607
MAZE	1976	613
CHECKMATE	1977	617
DOUBLE PLAY	1977	621
ROTATION VIII	1978	627
CLOWNS	1978	634
BOWLING ALLEY	1979	749
SPACE INVADERS	1979	775
SPACE INVADERS II	1980	851
SPACE INVADERS DELUXE	1980	870
GALAXIAN	1980	869
SPACE ZAP	1980	920
EXTRA BASES	1980	889
PAC-MAN	1980	933
GORF	1981	927
RALLY X	1981	936

CABLE — MIDCO  
TELEX NO. 72-1596



**MIDWAY MFG. CO.**

A BALLY COMPANY

10750 W. GRAND AVENUE • FRANKLIN PARK, ILL. 60131

PHONE: AREA CODE 312 451-1360

CHICAGO PHONE: 992-2250

### SERVICE BULLETIN

GAME (MINI)	DATE	GAME NUMBER
SPACE ENCOUNTERS	1980	905
SPACE ZAP	1980	908
PAC-MAN	1980	934
GORF	1981	926
RALLY X	1981	937



**MIDWAY MFG. CO.**

A BALLY COMPANY

10750 W. GRAND AVENUE • FRANKLIN PARK, ILL. 60131

PHONE: AREA CODE 312 451-1360

CHICAGO PHONE: 992-2250

### SERVICE BULLETIN

<b>GAME</b>	<b>POWER SUPPLY NUMBER</b>
GUN FIGHT (EARLY MODEL)	PC 80-901
GUN FIGHT TO SPACE ENCOUNTERS 8080 SYSTEM (1975 - 1980)	PC A082-90400-H000
SEAWOLF II	PC A082-90401-B000
ROTATION VIII	PC A082-90400-E000
SUPER SPEED RACE	PC A082-90401-C000
18 WHEELER	PC A082-90406-B000
SUBMARINE	PC A082-90406-B000
EXTRA BASES	PC A082-90408-D000
SPACE ZAP	PC A082-90411-A000
CORF	PC A082-90411-A000
WIZARD OF WOR	PC A082-90411-A000

ANDY DUCAY  
SERVICE MANAGER

AD/dd





**MIDWAY MFG. CO.**

A BALLY COMPANY

10750 W. GRAND AVENUE • FRANKLIN PARK, ILL. 60131

PHONE: AREA CODE 312 451-1360

CHICAGO PHONE: 992-2250

**SERVICE BULLETIN**

GAME: All Midway Games

CONDITION: Flipping pennies into return cup for free games.

\*\*\*\*\*

**REMEDY:**

Order from the Midway Parts Department an Anti-Penny Device Field Kit.  
Part number A090-00064-0000.

Install as per instructions.

Andy Ducay  
Service Manager

AD:jk  
2/13/80

## ANTI-PENNY DEVICE INSTALLATION

A090-00064-0000

1. REMOVE COIN ACCEPTOR FROM BRACKET.
2. REMOVE (3) HEX HEAD SCREWS THAT HOLD BRACKET TO DOOR.
3. REMOVE BRACKET FROM DOOR.
4. INSTALL ANTI-PENNY DEVICE MIDWAY PART NO. A090-00064-0000 USING (2) 6-32 x 5/16 SLOT HEX HEAD SCREWS MIDWAY PART NO. 0017-00101-0555. MOUNT DEVICE WITH 1 SCREW FROM THE FRONT AND 1 SCREW FROM THE BACK OF BRACKET AS SHOWN.
5. SCREW BRACKET BACK TO DOOR AND SNAP COIN ACCEPTOR BACK IN PLACE.

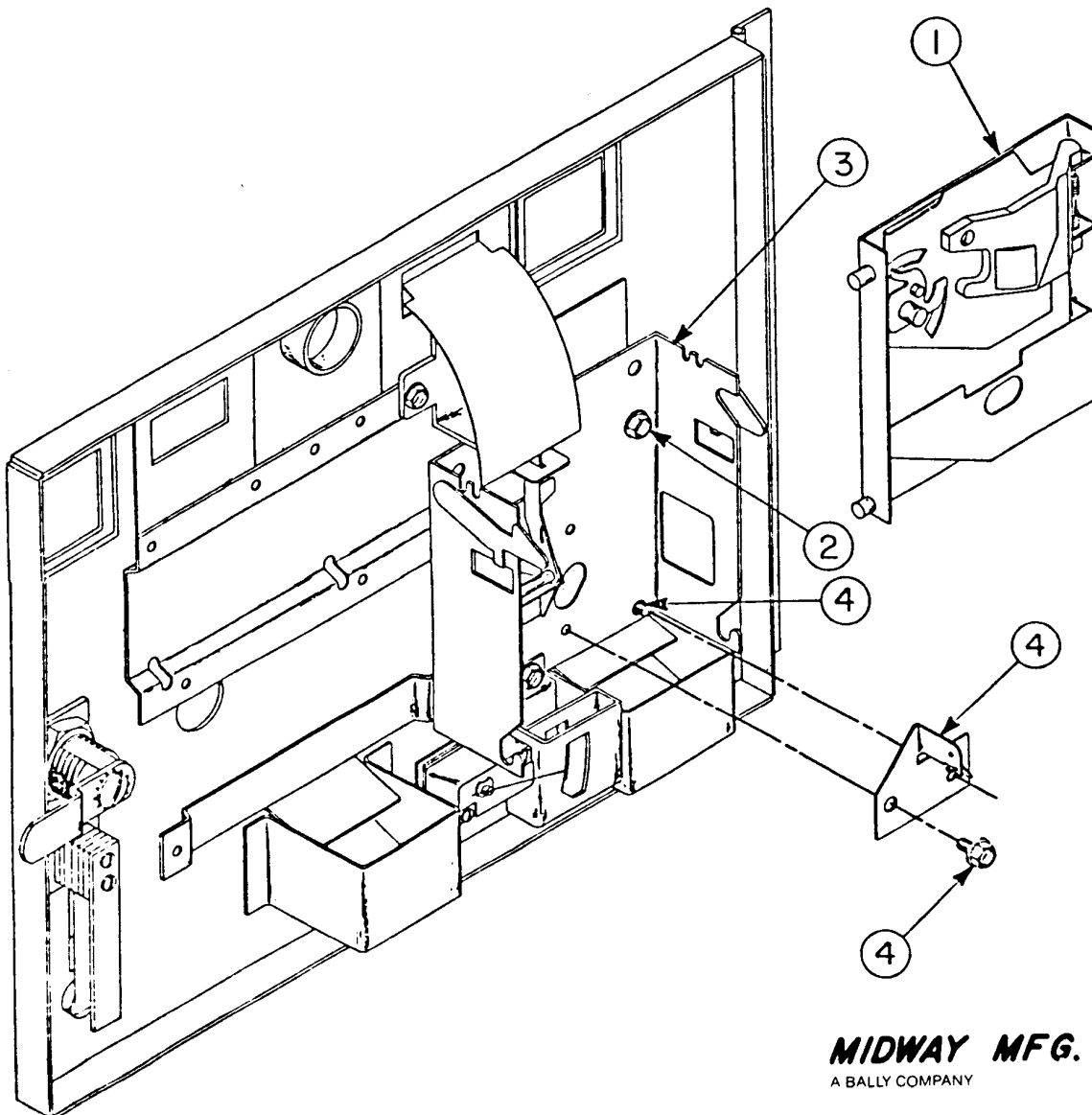

**MIDWAY MFG. CO.**  
A BALLY COMPANY



**MIDWAY MFG. CO.**

A BALLY COMPANY

10750 W. GRAND AVENUE • FRANKLIN PARK, ILL. 60131

PHONE: AREA CODE 312 451-1360

CHICAGO PHONE: 992-2250

**ANTI-STRING DEVICE INSTALLATION**

**A090-00061-0000**

**SERVICE BULLETIN**

1. REMOVE 1/8 LONG SLOT HEAD MACHINE SCREW.
2. INSTALL ANTI-STRINGING DEVICE MIDWAY PART NO. 0090-00907-0000.
3. REPLACE 1/8 LONG SLOT HEAD MACHINE SCREW (STEP 1) WITH 3/8 LONG SEMS PHILLIPS HEAD MACHINE SCREW. MIDWAY PART NO. 0017-00101-0339.
4. REMOVE (2) #4 SLOT HEAD MACHINE SCREWS WHICH MOUNT MICRO SWITCH AND SWITCH COIN GUIDE ASSEMBLY.
5. REPLACE SWITCH GOIN GUIDE ASSEMBLY WITH NEW SWITCH COIN GUIDE ASSEMBLY MIDWAY PART NO. A090-00060-0000. MOUNT MICRO SWITCH USING (2) #4 MACHINE SCREWS REMOVED IN STEP 4.

Andy Ducay  
Service Manager

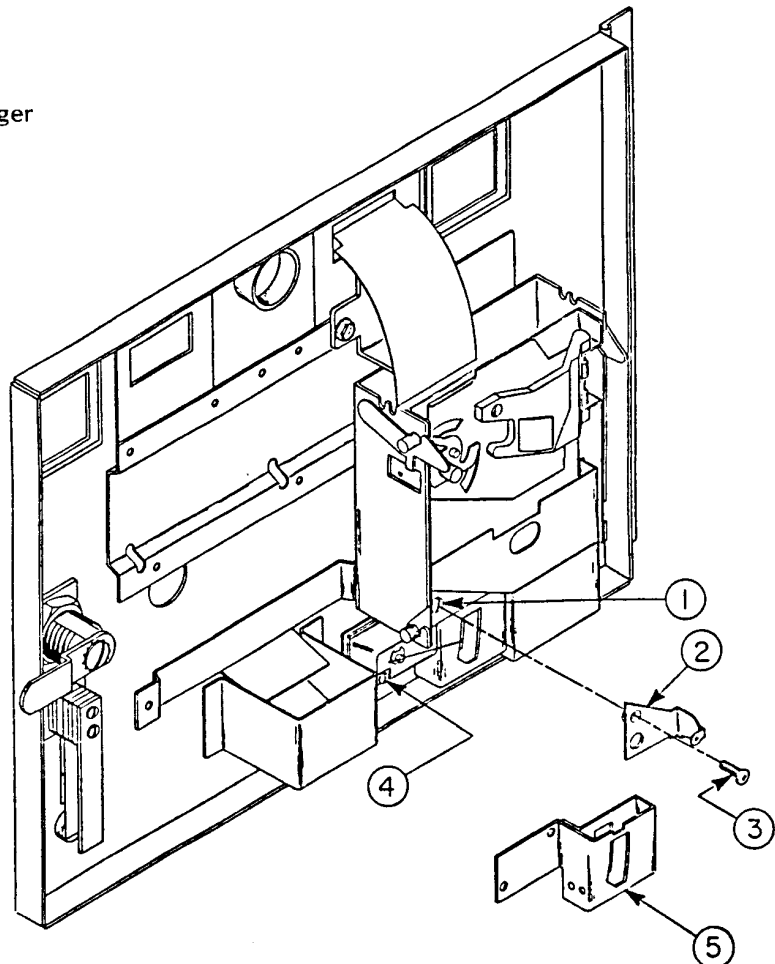

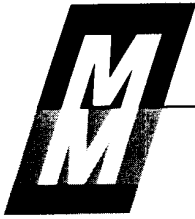

**MIDWAY MFG. CO.**

A BALLY COMPANY

10750 W. GRAND AVENUE • FRANKLIN PARK, ILL. 60131

PHONE: AREA CODE 312 451-1360

CHICAGO PHONE: 992-2250

June 11, 1981

## S E R V I C E   B U L L E T I N

GAME:      WIZARD OF WOR

SUBJECT:   NEW FEATURES

1. Wizard of Wor allows you to service the entire electronic system (with the exception of the video monitor) from the front of the cabinet. (upright only).
2. Wizard of Wor features lighted coin slots.
3. Wizard of Wor is equipped with wheels on the back of the cabinet for ease of movement.
4. Wizard of Wor is a talking video game that uses three speakers for improved sound.
5. Wizard of Wor features Midway's positive approach to increase price of play at the player's option. A single coin gives a player the standard number of Warriors, two coins for two players. If additional Warriors are desired, 2 coins will give 1 player twice as many Warriors plus an additional bonus Warrior. Four coins will give 2 players twice as many Warriors plus an additional bonus Warrior for each player.
6. New service outlet.
7. Fluorescent lamp fixture.
8. Wizard of Wor copyrighted and trademarked in accordance with the U.S. copyright laws. Midway will protect its proprietary rights against any infringers of Wizard of Wor.

ANDY DUCAY  
SERVICE MANAGER

AD/dd

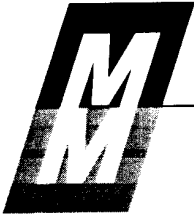

**MIDWAY MFG. CO.**

A BALLY COMPANY

10750 W. GRAND AVENUE • FRANKLIN PARK, ILL. 60131

PHONE: AREA CODE 312 451-1360

CHICAGO PHONE: 992-2250

June 11, 1981

**S E R V I C E   B U L L E T I N**

GAME:     RALLY X

SUBJECT:   RAM TEST MESSAGE CODE

1. The position of rams given in our Ram Test Message on page 6 of the Parts and Operating Manual is incorrect.
2. The correct Ram Test Message Code is shown in figure #1.
3. Each of the 2114 Rams are checked during the Ram Test and when any irregularity is found a test message (e.g. Ram 0L) is displayed and the test series stops. If there is no irregularities in the rams the sound and switch test begins.
4. The Ram Test is only for the 2114 Rams.

ANDY DUCAY  
SERVICE MANAGER

AD/dd

**FIGURE #1**

<b>Test Message</b>	<b>Position of RAM on PCB</b>
RAM 0L	6C
RAM 0H	6A
RAM 1L	6D
RAM 1H	6B
RAM 2L	6K
RAM 2H	6J
RAM 3L	6L
RAM 3H	6H
RAM 4L	6M
RAM 4H	6F
RAM 5L	6N
RAM 5H	6E

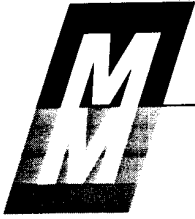

**MIDWAY MFG. CO.**

A BALLY COMPANY

10750 W. GRAND AVENUE • FRANKLIN PARK, ILL. 60131

PHONE: AREA CODE 312 451-1360

CHICAGO PHONE: 992-2250

**SERVICE BULLETIN**

GAME: GORF

SUBJECT: NEW 6 CARD Z-80 SYSTEM USING A CARD RACK

\*\*\*\*\*

GAME CARD (PC A084-90708-A873)  
I&O CUSTOM CHIP (TWO)  
TALKING CHIP - SC-01

ROM & RAM CARD (A082-91364-A000)  
DOMESTIC & FOREIGN (A082-91374-A000)  
RAMS 2114  
ROMS 9316 OR 9332

CPU CARD (A082-91354-E000)  
Z80 CPU  
ADDRESS CUSTOM CHIP  
DATA CUSTOM CHIP  
CRYSTAL 14,318

RAM CARD (A082-91356-0000)  
TWO RAM CARDS  
16 RAM EACH (M4027)

PATTERN CARD (PC 082-91355-C000)  
SHIFTS INFORMATION AT A FASTER RATE

POWER SUPPLY (PC 082-90411-A000)  
SAME AS SPACE ZAP

NOTE: ALL PC CARDS EDGE CONNECTORS ARE GOLD PLATED.

Andy Ducay  
Service Manager

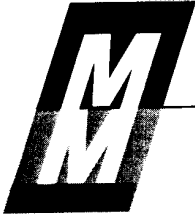

**MIDWAY MFG. CO.**

A BALLY COMPANY

10750 W. GRAND AVENUE • FRANKLIN PARK, ILL. 60131

PHONE: AREA CODE 312 451-1360

CHICAGO PHONE: 992-2250

April 27, 1981

**S E R V I C E   B U L L E T I N**

GAME:     GORF

SUBJECT:   ROM PROGRAM CHANGE

1. Rom program number two is now in all Gorf games which will make the game harder to play after the 5th mission.
2. The roms will not be interchangeable between program number one and two.
3. The rom code and board location of program number one and two roms. See the code and location chart.
4. The rom location on domestic and foreign rom/ram boards are different.

ANDY DUCAY  
SERVICE MANAGER

AD/dd





**MIDWAY MFG. CO.**

A BALLY COMPANY

10750 W. GRAND AVENUE • FRANKLIN PARK, ILL. 60131

PHONE: AREA CODE 312 451-1360

CHICAGO PHONE: 992-2250

**ROM CODE AND LOCATION CHART**

**Domestic Rom/Ram Board  
PC A082-91364-A000**

PROGRAM NUMBER ONE

<u>ROM CODE</u>	<u>LOCATION</u>
M873A-0850	x-1
M873B-0850	x-3
M873C-0850	x-5
M873D-0850	x-7
M873E-0850	x-11
M873F-0850	x-13
M873G-0850	x-15
M873H-0850	x-17

**Foreign Rom/Ram Board  
PC A082-91374-A000**

<u>ROM CODE</u>	<u>LOCATION</u>
M873A-0850	x-1
M873B-0850	x-2
M873C-0850	x-3
M873D-0850	x-4
M873E-0850	x-5
M873F-0850	x-6
M873G-0850	x-7
M873H-0850	x-8



**MIDWAY MFG. CO.**

A BALLY COMPANY

10750 W. GRAND AVENUE • FRANKLIN PARK, ILL. 60131

PHONE: AREA CODE 312 451-1360

CHICAGO PHONE: 992-2250

**ROM CODE AND LOCATION CHART**  
**Domestic Rom/Ram Board**  
**PC A082-91364-A000**

**PROGRAM NUMBER TWO**

ROM CODE	LOCATION
873-109AXR-AXSD	x-1
873-109AXR-BXSD	x-3
873-109AXR-CXSD	x-5
873-109AXR-DXSD	x-7
873-109AXR-EXSD	x-11
873-109AXR-FXSD	x-13
873-109AXR-GXSD	x-15
873-109AXR-HXSD	x-17

**Foreign Rom/Ram Board**  
**PC A082-91374-A000**

ROM CODE	LOCATION
873-109AXR-AXSD	x-1
873-109AXR-BXSD	x-2
873-109AXR-CXSD	x-3
873-109AXR-DXSD	x-4
873-109AXR-EXSD	x-5
873-109AXR-FXSD	x-6
873-109AXR-GXSD	x-7
873-109AXR-HXSD	x-8

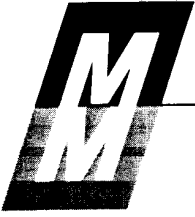

**MIDWAY MFG. CO.**

A BALLY COMPANY

10750 W. GRAND AVENUE • FRANKLIN PARK, ILL. 60131

PHONE: AREA CODE 312 451-1360

CHICAGO PHONE: 992-2250

April 3, 1981

**S E R V I C E   B U L L E T I N**

GAME:      GORF

SUBJECT: ALLEN KEY 1/8" TAMPER PROOF WRENCH  
(0017-00009-0484)

The operator can not service the control grip without this special wrench.

Enclosed, please find a spare tamper proof wrench.

ANDY DUCAY  
SERVICE MANAGER

AD/pc

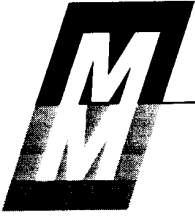

**MIDWAY MFG. CO.**

A BALLY COMPANY

10750 W. GRAND AVENUE • FRANKLIN PARK, ILL. 60131

PHONE: AREA CODE 312 451-1360

CHICAGO PHONE: 992-2250

March 30, 1981

**S E R V I C E   B U L L E T I N**

GAME:     PAC-MAN, RALLY X, & GORF

SUBJECT: ANTI-STATIC CLEANER APPLICATION

When a game has a plexiglas front glass and or tinted Plexiglas T.V. tube overlay, anti-static cleaner must be used.

When using any anti-static cleaner, both surfaces of the Plexiglas must be sprayed and cleaned individually. Also, as a new policy, we will be using this same anti-static cleaner to clean the C.R.T. This is most important since this is the prime source of static discharge.

In the past we have been using a anti-static cleaner called K-Lux. We will continue using this product until the stock has been depleted. We will then begin using a new product called Merix Anti-Static No. 79 Concentrate (0017-00008-0091). This concentrate must be diluted 1:10 - 1 part concentrate; 10 parts H<sub>2</sub>O.

Please read caution label before using.

ANDY DUCAY  
SERVICE MANAGER

AD/pc

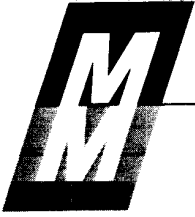

**MIDWAY MFG. CO.**

A BALLY COMPANY

10750 W. GRAND AVENUE • FRANKLIN PARK, ILL. 60131

PHONE: AREA CODE 312 451-1360

CHICAGO PHONE: 992-2250

April 9, 1981

**S E R V I C E   B U L L E T I N**

GAME:      PAC-MAN, RALLY X & GORF

SUBJECT:   NEW BACK DOOR, #350 KEYS

Some Pac-Man, Rally X & Gorf will have the new Illinois locks with #350 keys.

Extra Illinois locks with #350 keys can now be ordered from our parts department.

All operators must order locks and keys from their local distributor.

ANDY DUCAY  
SERVICE MANAGER

AD/pc

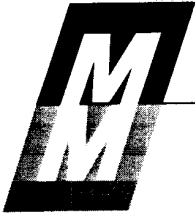

**MIDWAY MFG. CO.**

A BALLY COMPANY

10750 W. GRAND AVENUE • FRANKLIN PARK, ILL. 60131

PHONE: AREA CODE 312 451-1360

CHICAGO PHONE: 992-2250

March 30, 1981

**S E R V I C E   B U L L E T I N**

GAME:      PAC-MAN (UPRIGHT & MINI)

SUBJECT:    CREDIT MULTIPLIER  
              BYPASS JACK PC# A080-9109-A000

The credit unit bypass jack is not needed when a credit multiplier unit is used.  
PC# A082-01348-C000.

The credit multiplier is for foreign games, for additional credits.

When the credit multiplier is missing the coin jack must be inserted to the  
credit bypass jack for proper coin operation.

ANDY DUCAY  
SERVICE MANAGER

AD/pc



**MIDWAY MFG. CO.**

A BALLY COMPANY

10750 W. GRAND AVENUE • FRANKLIN PARK, ILL. 60131

PHONE: AREA CODE 312 451-1360

CHICAGO PHONE: 992-2250

May 15, 1981

**S E R V I C E   B U L L E T I N**

GAME:      PAC-MAN & RALLY X

SUBJECT:    BRIGHTNESS ADJUSTMENT  
              WELLS GARDNER COLOR MONITOR (K4604 - 4)

1. To set the brightness level on a Wells Gardner Color Monitor, use the Black Level Control located on the interface PC Board.
2. Location of the Black Level Control can be found by following the logic board video cable which will be connected to the Interface PC Board.
3. Do not alter the screen control on the neck board, this can distort the picture when used as a brightness control.

ANDY DUCAY  
SERVICE MANAGER

AD/dd



**MIDWAY MFG. CO.**

A BALLY COMPANY

10750 W. GRAND AVENUE • FRANKLIN PARK, ILL. 60131

PHONE: AREA CODE 312 451-1360

CHICAGO PHONE: 992-2250

**SERVICE BULLETIN**

GAME: PAC-MAN

SUBJECT: CUSTOM CHIPS 6-D and 5-S

\*\*\*\*\*

When the custom chips are not available due to a supply problem the following alternate plug in units will be used.

1. At location 6-D PC 082-91383-B000 Z80 sync buss controller.
2. At location 5-S PC 082-91384-B000 V-Ram Addresser.

Andy Ducay  
Service Manager

AD/dc



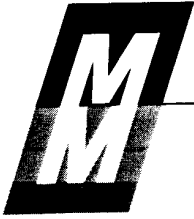

**MIDWAY MFG. CO.**

A BALLY COMPANY

10750 W. GRAND AVENUE • FRANKLIN PARK, ILL. 60131

PHONE: AREA CODE 312 451-1360

CHICAGO PHONE: 992-2250

11-13-80

**SERVICE BULLETIN**

GAME: PAC-MAN

SUBJECT: DIP SWITCH SETTING (7 & 8)

\*\*\*\*\*

1. Switches 7 & 8 must be in the off position for proper game operation.
2. When switch #7 is on, a test of all racks is possible.
3. When switch #8 is on, the picture will lock up.
4. The above information will be added to all switch setting cards.

Andy Ducay  
Service Manager

AD/pr



**MIDWAY MFG. CO.**

A BALLY COMPANY

10750 W. GRAND AVENUE • FRANKLIN PARK, ILL. 60131

PHONE: AREA CODE 312 451-1360

CHICAGO PHONE: 992-2250

January 8, 1981

**SERVICE BULLETIN**

GAME: PAC-MAN

SUBJECT: ROM-RAM TEST

\*\*\*\*\*

**BAD ROM LOCATION CODE**

DISPLAY	LOCATION
M-Rom-0	6E
M-Rom-1	6F
M-Rom-2	6H
M-Rom-3	6J

**BAD RAM LOCATION CODE**

DISPLAY	LOCATION
Bad V Ram-0	4K
Bad V Ram-1	4N
Bad C Ram-0	4L
Bad C Ram-1	4P
Bad W Ram-0	4M
Bad W Ram-1	4R

ANDY DUCAY  
SERVICE MANAGER

AD/pc

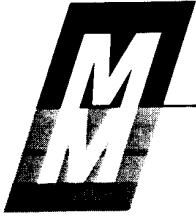

**MIDWAY MFG. CO.**

A BALLY COMPANY

10750 W. GRAND AVENUE • FRANKLIN PARK, ILL. 60131

PHONE: AREA CODE 312 451-1360

CHICAGO PHONE: 992-2250

**SERVICE BULLETIN**

November 19, 1980

GAME: SPACE ZAP, GORF & WIZARD OF WOR

SUBJECT: Card Rack System Test Equipment

\*\*\*\*\*

To aid board repair the following test cards are available.

1. A Ram Test card to locate a bad Ram. A082-91516-A000.
2. A Card Rack Test card which is used with the Ram Test Card and will also test the pattern card. A082-91517-A000.
3. Order test cards from Midway's Parts Department.

Andy Ducay  
Service Manager

AD/dc



**MIDWAY MFG. CO.**

A BALLY COMPANY

10750 W. GRAND AVENUE • FRANKLIN PARK, ILL. 60131

PHONE: AREA CODE 312 451-1360

CHICAGO PHONE: 992-2250

December 11, 1980

**SERVICE BULLETIN**

GAME: SPACE ENCOUNTERS

SUBJECT: Strobe unit PC A084-91359-B645  
Serial No. 101 to 3700

MODIFICATION: (see figure #1)

\*\*\*\*\*

1. Change resistor R3 and R5 to one of the following values.
  1. 300 ohms, 20 watts. 10%.
  2. 310 ohms, 20 watts. 10%.
2. Capacitor C-2 and C-3 should be 22MF., 250 V.
3. Check electrically.

ANDY DUCAY  
SERVICE MANAGER

FIGURE 1

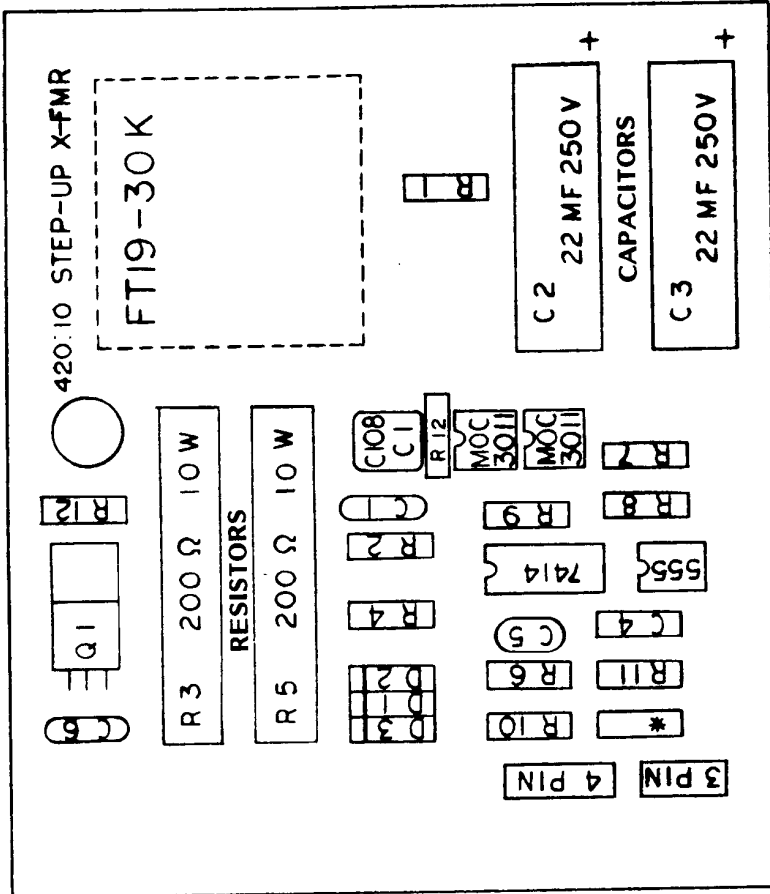

**NOTE**

- D1 23 IN4004
- \* .1 MF AX. CER.
- C1 0.1 MF 200V MYLAR
- C4 .01 MF AX. CER.
- C5 .1 MF 100V MYLAR
- C6 0.01 MF 250V MYLAR
- R1 1 M
- R2 10 K
- R4 180 K
- R6 820 Ω
- R7 220 Ω
- R8 1.6 M
- R9 1 K
- R10 330 Ω
- R11 220 Ω
- R12 180 Ω
- Q1 SC141D

REVISIONS	

USED ON SPACE ENCOUNTER		MIDWAY MFG. CO.	
NO. REQ'D 1 PER		FRANKLIN PK. ILL.	
SCALE		PART NO.	
HEAT TREAT		A084-91359-B645	
MATERIAL		ASSEMBLY DRAWING	
FINISH		STROBE AND LIGHT P.C.	
DO NOT SCALE DWG.		DATE 7/3/80	
DIM. TOLERANCES UNLESS SPECIFIED		DRN. <i>CL</i>	
CONCENTRICITY T.I.R. .003		CKD.	
FRACTIONAL ..... 1/84		DATE 7/3/80	
DECIMAL ..... 1.005			
HOLE DIA. .... +.002 - .000			

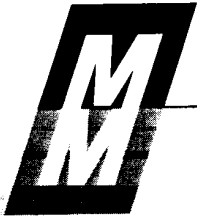

**MIDWAY MFG. CO.**

A BALLY COMPANY

10750 W. GRAND AVENUE • FRANKLIN PARK, ILL. 60131

PHONE: AREA CODE 312 451-1360

CHICAGO PHONE: 992-2250

## SERVICE BULLETIN

November 19, 1980

GAME: SPACE ENCOUNTERS

SUBJECT: Trigger Switch Kit

\*\*\*\*\*

1. Due to field failures a new trigger switch is now available.
2. The switch and hand grip assembly kit may be ordered from the parts department. (A645-00042-0000).

Andy Ducay  
Service Manager

AD/dc

# NO. 645-SPACE ENCOUNTERS-UPRIGHT SWITCH AND HAND GRIP ASSEMBLY INSTRUCTIONS

(KIT ASSY. NO. A645-00042-0000)

## ASSEMBLY INSTRUCTIONS

- APPLY LOCTITE NO. 242 (P/N 0017-00009-0238) TO ALL THREADS BEFORE ASSY.
- SWITCH TO BE WIRED PRIOR TO ASSEMBLY.
- SCREW SWITCH INTO BOTTOM OF SWITCH HOUSING UNTIL SHOULDER BOTTOMS ON SWITCH HOUSING AS SHOWN.
- SLIDE SWITCH AND HOUSING ASSY. INTO TUBE. TIGHTEN SET SCREWS(2) TO RETAIN.
- SLIDE PUSH BUTTON INTO SWITCH HOUSING.
- PUSH RUBBER GRIP ONTO TUBE UNTIL FULLY SEATED.
- PUSH BEZEL ON PAST LIP OF RUBBER GRIP AND ENGAGE THREADS. TIGHTEN UNTIL FULLY SEATED.

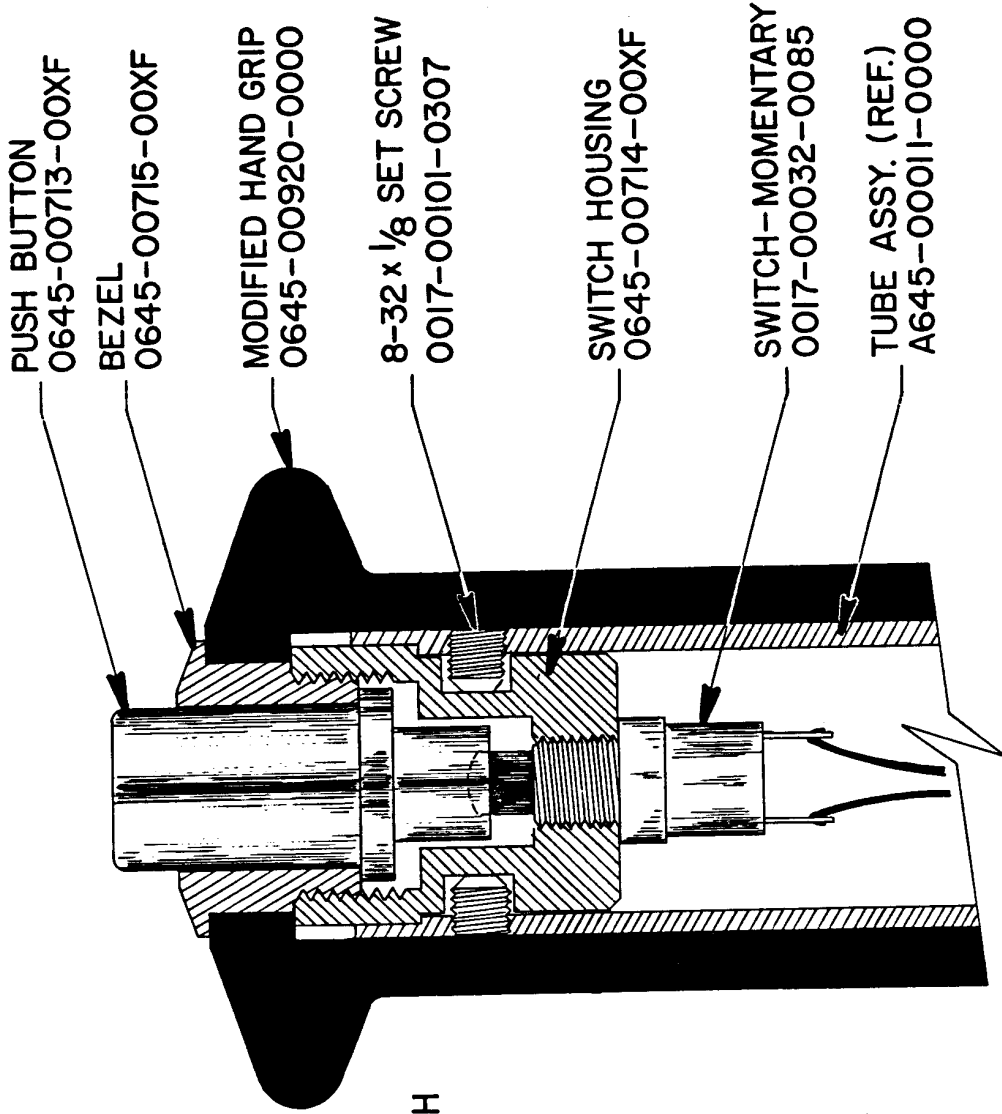

PUSH BUTTON  
0645-00713-00XF

BEZEL  
0645-00715-00XF

MODIFIED HAND GRIP  
0645-00920-0000

8-32 x 1/8 SET SCREW  
0017-00101-0307

SWITCH HOUSING  
0645-00714-00XF

SWITCH-MOMENTARY  
0017-00032-0085

TUBE ASSY. (REF.)  
A645-00011-0000



**MIDWAY MFG. CO.**

A BALLY COMPANY

10750 W. GRAND AVENUE • FRANKLIN PARK, ILL. 60131

PHONE: AREA CODE 312 451-1360

CHICAGO PHONE: 992-2250

### SERVICE BULLETIN

GAME: Space Encounters

SUBJECT: Angle Encoders

1. Due to a shortage of Encoders some games will have 25K pots. (two)
2. For proper operation of pots a A/G converter. PC A082-91377-B000 has been added.
3. The A/G Converter PC is mounted under the control panel.
4. Refer to instruction adjustment for proper pot alignment.

Andy Ducay  
Service Manager

AD/dc



## SPACE ENCOUNTERS U.R. AND MINI

### INSTRUCTIONS TO ADJUST CONTROL PANEL: "B" VERSION

1. Place adjustment switch (5) "OFF" and (6) "ON".
2. Press trigger button, located on steering control to set test mode.
3. On P.C. board A082-91377-B000, rotate Pot A clockwise and Pot B counter-clockwise.
4. Push steering control forward, rotate vertical pot until defense ship is in its' furthest position. Back off pot until ship starts to come back down. Tighten set screw.
5. Put steering control in its' furthest out position. Rotate Pot A until defense ship stops in lower part of viewing area.
6. Put steering control all the way to the left.
7. Turn horizontal pot until defense ship is to the left side of the tunnel.
8. Tighten set screw.
9. Turn control to the right and adjust Pot B until the defense ship reaches the right side of the tunnel.

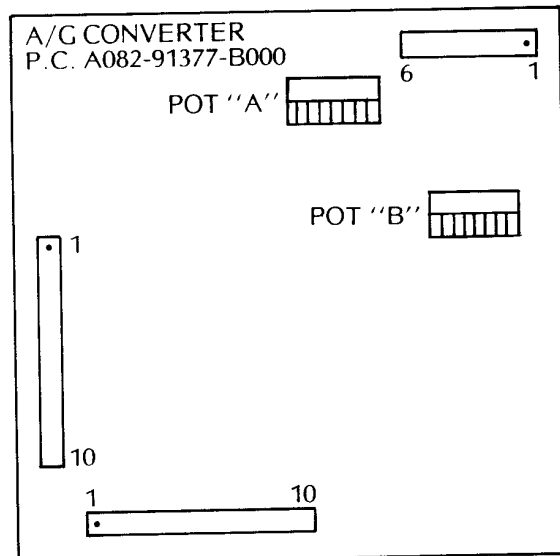



**MIDWAY MFG. CO.**

A BALLY COMPANY

10750 W. GRAND AVENUE • FRANKLIN PARK, ILL. 60131

PHONE: AREA CODE 312 451-1360

CHICAGO PHONE: 992-2250

## SERVICE BULLETIN

GAME: Space Encounters

SUBJECT: Power Supply PC0080-00904H

Condition:

The power supply +5 voltage may shut down in certain games due to an overload. The 0.18 5 watt resistor tolerance will affect the +5 volts. shut down.

Modification:

1. Replace the 0.18 resistor with another 10% tolerance type (better tolerance).
2. Replace the 0.18 resistor with a 5% tolerance if available.
3. Parallel a 1.5 1 watt resistor across the 0.18 resistor (rear side).
4. Check game electrically.

Note: This power supply overload only occurs in Space Encounters.

Andy Ducay  
Service Manager

AD/cm



**MIDWAY MFG. CO.**

A BALLY COMPANY

10750 W. GRAND AVENUE • FRANKLIN PARK, ILL. 60131

PHONE: AREA CODE 312 451-1360

CHICAGO PHONE: 992-2250

April 16, 1980

**SERVICE BULLETIN**

GAME: Galaxian (Serial No. #101 to #8400)

SUBJECT: Loss of Credit

\*\*\*\*\*

**MODIFICATION:**

1. Install 100MF 10V capacitor to coin switch terminals as shown in Figure #1.
2. Capacitor is only needed at one coin switch.
3. Check game electrically.

Figure #1

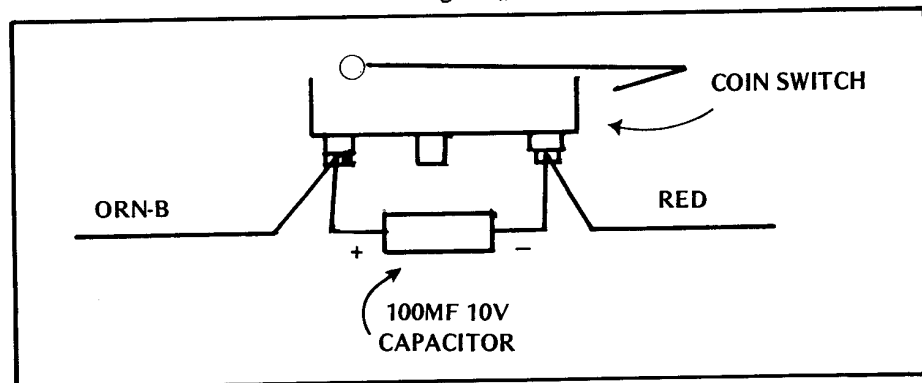

Andy Ducay  
Service Manager

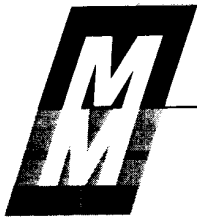

**MIDWAY MFG. CO.**

A BALLY COMPANY

10750 W. GRAND AVENUE • FRANKLIN PARK, ILL. 60131

PHONE: AREA CODE 312 451-1360

CHICAGO PHONE: 992-2250

April 29, 1980

### SERVICE BULLETIN

GAME: GALAXIAN & PAC-MAN

SUBJECT: Static Condition Causing A False  
Ram and Rom Test.

\*\*\*\*\*

#### MODIFICATION:

1. Order from the Midway Parts Department an Anti-Static Kit PC A866-00078-0000 and install as shown in instruction diagram. (Fig. #1)
2. Check game out electrically.

Andy Ducay  
Service Manager

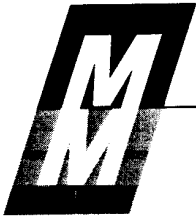

**MIDWAY MFG. CO.**

A BALLY COMPANY

10750 W. GRAND AVENUE • FRANKLIN PARK, ILL. 60131

PHONE: AREA CODE 312 451-1360

CHICAGO PHONE: 992-2250

February 11, 1980

## SERVICE BULLETIN

GAME: Galaxian

\*\*\*\*\*

### GAME BOARD TEST

If game board is good, the following information will be displayed on the screen:

- OK
- Coin Adjustment Setting
- Bonus Adjustment Setting
- No. of Galixip Per Game Setting

### RAM/ROM TEST

If any of the Rams or Roms are faulty, the following information will be displayed on the screen:

- "Bad Ram 1" — indicates bad Ram at location 7N or 7P.
- "Bad Ram 2" — indicates bad Ram at location 3F or 3H.
- "Bad Ram 3" — indicates bad Ram at location 4FH or 5FH.
- "Bad Rom" — indicates bad Rom on memory board.

\*NOTE: Early models were not equipped with memory boards. In these models, "Bad Rom" indicates bad Rom at location 7F or 7H.

### CONTROL PANEL and COIN SWITCH TEST

To verify operation of any switch, close switch in question. If the switch is operating properly, a game sound will emit when closure is made.

CAUTION: Be sure to return test switch to game mode when all tests are completed.

Andy Ducay  
Service Manager

AD/jk



**MIDWAY MFG. CO.**

A BALLY COMPANY

10750 W. GRAND AVENUE • FRANKLIN PARK, ILL. 60131

PHONE: AREA CODE 312 451-1360

CHICAGO PHONE: 992-2250

## GALAXIAN LOGIC BOARD

### SERVICE BULLETIN

\*\*\*\*\*

There are two (2) versions of the Galaxian Program. They are:

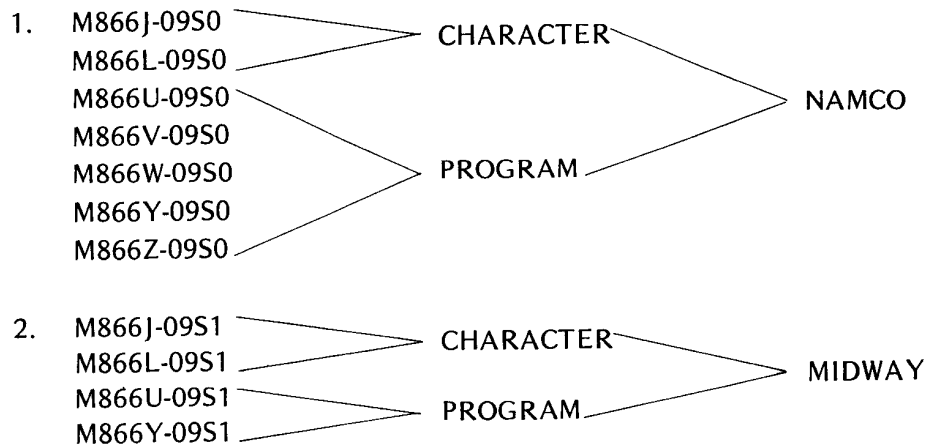

The Midway Roms and the Namco Roms CHARACTER CANNOT be mixed. It will result in the super-imposing of the names in the attract mode of the game.

However the Midway and Namco Program can be mixed with one exception and that is the locations U & Y. If you use one you'll have to use the other or you'll get a BAD ROM read-out.

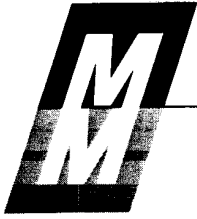

**MIDWAY MFG. CO.**

A BALLY COMPANY

10750 W. GRAND AVENUE • FRANKLIN PARK, ILL. 60131

PHONE: AREA CODE 312 451-1360

CHICAGO PHONE: 992-2250

May 6, 1980

**SERVICE BULLETIN**

GAME: Galaxian (As of Serial No. 11,500)  
SUBJECT: Rom program identification (3rd Program)

\*\*\*\*\*

1. The 3rd program change has new Bonus Values. (see Figure #1).
2. New program identification (Game, Location and Program).
  - M866 - U - 09S2
  - M866 - V - 09S2
  - M866 - W - 09S2
  - M866 - Y - 09S2
  - M866 - Z - 09S2
3. The 1st program version 09S0 and 2nd program version 09S1 can not mix with 3rd program 09S2.
4. The 1st and 2nd program has 2716 Proms and also 2716 Proms mixed with 9316 Roms.
5. If additional clarification is needed please call the service department.
6. New Program Bonus Values are as follows (Figure #1).

	SW. 3	SW. 4
Bonus Galaxip at 7000 pts.	OFF	ON
Bonus Galaxip at 10,000 pts.	ON	OFF
Bonus Galaxip at 12,000 pts.	OFF	ON
Bonus Galaxip at 20,000 pts.	ON	OFF

Andy Ducay  
Service Manager



**MIDWAY MFG. CO.**

A BALLY COMPANY

10750 W. GRAND AVENUE • FRANKLIN PARK, ILL. 60131

PHONE: AREA CODE 312 451-1360

CHICAGO PHONE: 992-2250

### SERVICE BULLETIN

GAME: GALAXIAN

SUBJECT: Alternate PC A082-91370-000

1. Due to a supply problem an alternate PC Board may be located at position 8F, 8H, and 4J, 4K.
2. The alternate PC Board replaces the Bi-directional Drivers 8216, 8304, and 74LS245. (8F, 8H, 4J, 4K, 9B, and 5J).
3. The ICs on the alternate PC Board are 74LS244 and 74S00.
4. The alternate PC Board can be removed and ICs 8216, 8304, and 74LS245 can be used in the proper location.

Andy Ducay  
Service Manager

AD/dc  
8/7/80



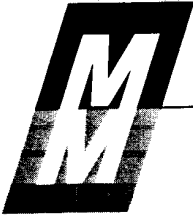

**MIDWAY MFG. CO.**

A BALLY COMPANY  
10750 W. GRAND AVENUE • FRANKLIN PARK, ILL. 60131

PHONE: AREA CODE 312 451-1360

CHICAGO PHONE: 992-2250

June 5, 1980

SERVICE BULLETIN

GAME: Galaxian

SUBJECT: When Ram Test reads Bad Ram #2 and Rams are Good.

\*\*\*\*\*

PROBABLE REMEDY

1. Replace Bi-Directional Driver at location 9-B or 5-J (74C245).
2. Alternate chips 8216 and 8304 may be used as replacements.
3. Refer to Galaxian Parts and Operating Manual component layout page #20 for alternate locations.

Andy Ducay  
Service Manager

AD/dc



**MIDWAY MFG. CO.**

A BALLY COMPANY

10750 W. GRAND AVENUE • FRANKLIN PARK, ILL. 60131

PHONE: AREA CODE 312 451-1360

CHICAGO PHONE: 992-2250

November 7, 1980

**SERVICE BULLETIN**

SUBJECT: MONITOR'S MIDWAY GAMES

\*\*\*\*\*

<b>MANUFACTURE</b>	<b>MODEL NO.</b>	<b>GAME</b>
WELLS GARDNER	19K4500 (19'')	GALAXIAN UR
WELLS GARDNER	19K4601 (19'')	GALAXIAN UR & CT
ELECTROHOME	G02 (25'')	GALAXIAN UR
ELECTROHOME	G07-901 & 904	UPRIGHT & COCKTAIL
ELECTROHOME	V-17 (15'')	SPACE ZAP, SPACE ENCOUNTERS MINI
WELLS GARDNER	V1001 (19'')	SPACE ZAP & SPACE ENCOUNTERS
MOTOROLA	M-500 (19'')	SPACE ZAP & SPACE ENCOUNTERS
ELECTROHOME	G07 (13'')	PAC-MAN, GORF & RALLY-X

Andy Duca  
Service Manager

AD/dc



**MIDWAY MFG. CO.**

A BALLY COMPANY

10750 W. GRAND AVENUE • FRANKLIN PARK, ILL. 60131

PHONE: AREA CODE 312 451-1360

CHICAGO PHONE: 992-2250

## SERVICE BULLETIN

GAME: GALAXIAN, PAC-MAN & GORF

SUBJECT: Electrohome 19" Color Monitor

\*\*\*\*\*

Static convergence (in the center of the monitor) is achieved by manipulating four magnets located on the neck of the CRT nearest the base of the tube. The middle pair of rings adjust the red and blue crosshatch. The rear pair of rings adjusts the blue/red to the green crosshatch lines. Dynamic Convergence is handled by tilting the yoke up, down, left and right, then securing it with wedges. Refer to the game schematic for Diagnostic Tests that generate crosshatch and background colors.

- A. Tilt the yoke up, down, left and right to achieve convergence around the edges. Secure with one temporary wedge.
- B. Rotate the center rings to adjust the red and blue separation.
- C. Rotate the rear rings to adjust the magenta (red-blue) and green separation; when best results are obtained, seal the rings with nail polish.
- D. Remove the temporary wedge from the yoke. Tilt the yoke again to adjust the edges of the screen for minimum separation and insert three new wedges. These should have adhesive added to hold them permanently.

See figure #1.

Andy Ducay  
Service Manager

FIGURE 1

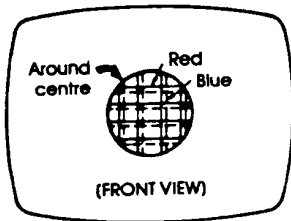
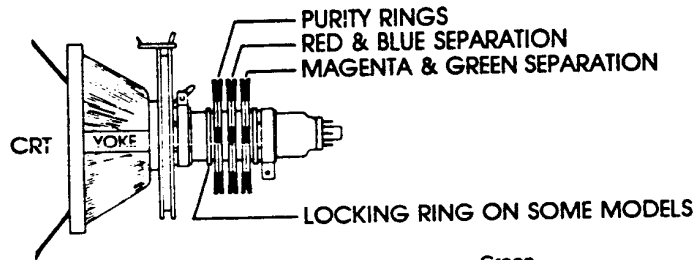

Let the red and blue lines come in line by turning two 4-pole magnets.

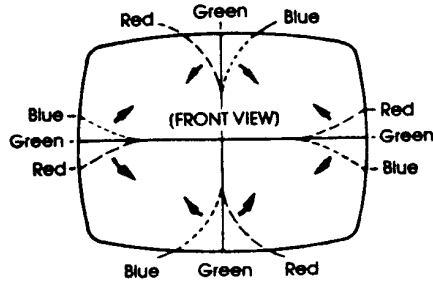

Tilting the yoke upward will move the lines as shown with the arrows.

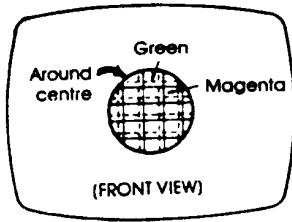

Let the green and magenta lines come in line by turning two 6-pole magnets.

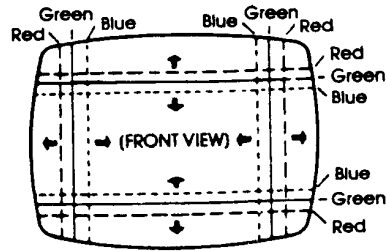

Tilting the yoke to the right will move the lines as shown with the arrows.

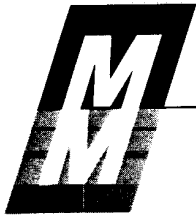

**MIDWAY MFG. CO.**  
A BALLY COMPANY  
10750 W. GRAND AVENUE • FRANKLIN PARK, ILL. 60131

PHONE: AREA CODE 312 451-1360  
CHICAGO PHONE: 992-2250

### SERVICE BULLETIN

GAME: GALAXIAN

\*\*\*\*\*

1. Proper video cable wire sequence for interface PC, Wells Gardner color monitor 19K4500. (See Figure #1)

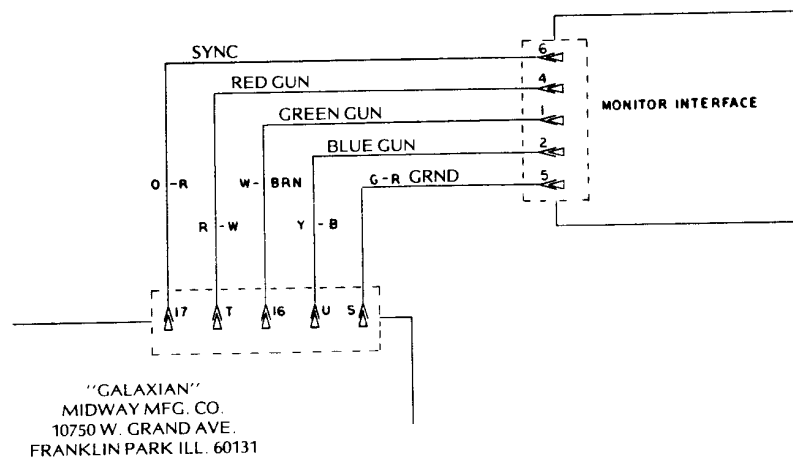

Figure #1

NOTE: The 19K4500 is used only in upright games.

2. Proper video cable wire sequence for interface PC, Wells Gardner color monitor 19K4601. (upright) (See Figure #2)

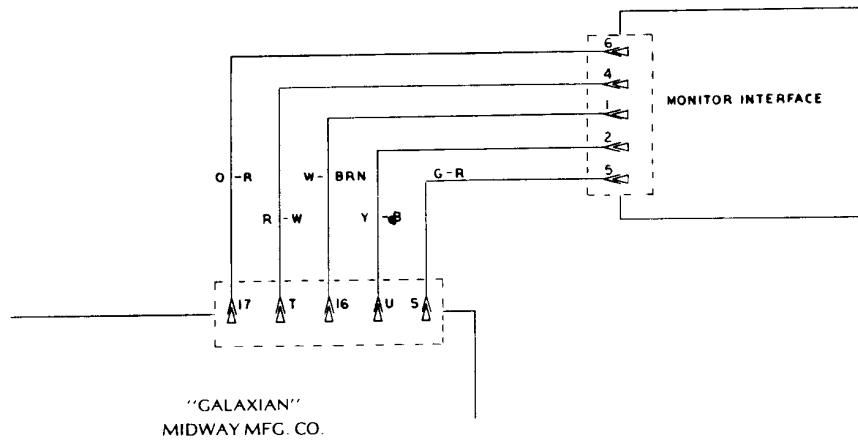

Figure #2

NOTE: The cocktail table main cable is wired for the Electrohome monitor and must be altered when installing a Wells Gardner monitor. (Same wire sequence as above)

3. Proper video cable wire sequence for interface PC, Electrohome 19" color monitor G07 - 901 & 905 (upright & cocktail table). (See Figure #3)

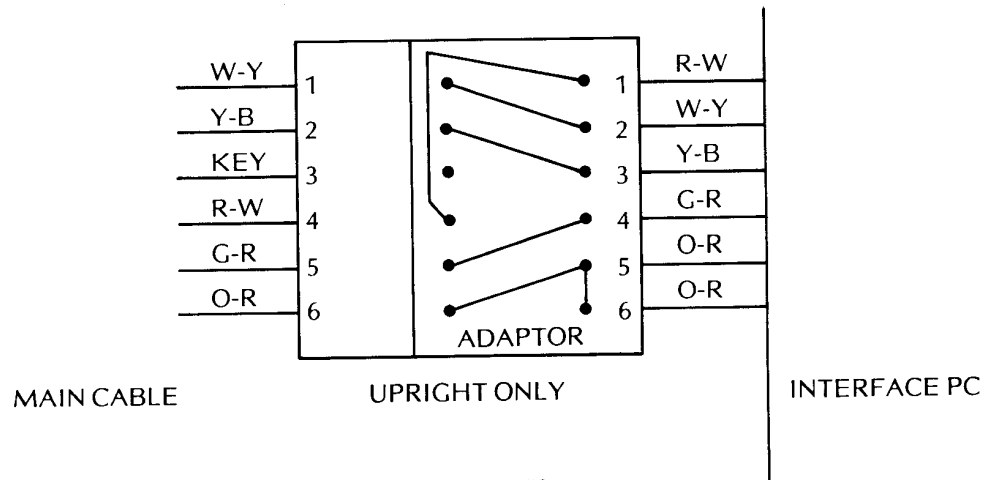
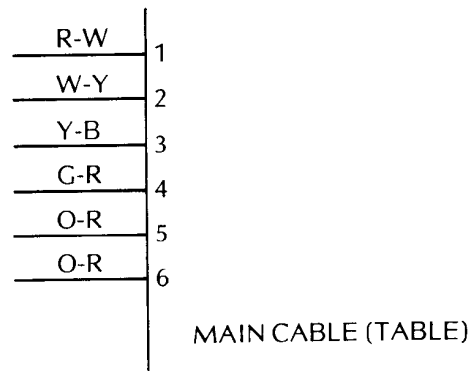

Figure #3

- NOTE: 1. The adaptor Jack PC A080 - 91106 is used in upright games for proper wire sequence.
2. The cocktail table wire sequence if for the Electrohome Monitor.



- Proper video cable wire sequence for interface PC, Electrohome color monitor. G02 - 25 inch (upright). (See Figure #4)

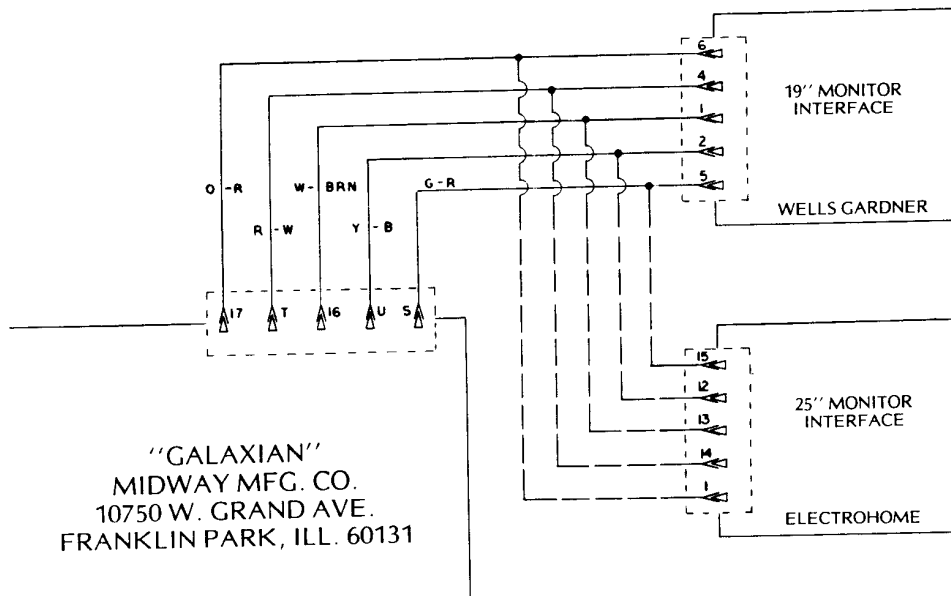

Figure #4

NOTE: Due to cable changes and other modifications the 25 inch color monitor must be used.



5. Proper video cable wire sequence for interface PC, Electrohome color monitor G07 CB0 - 904. (upright & cocktail table). (See Figure #5)

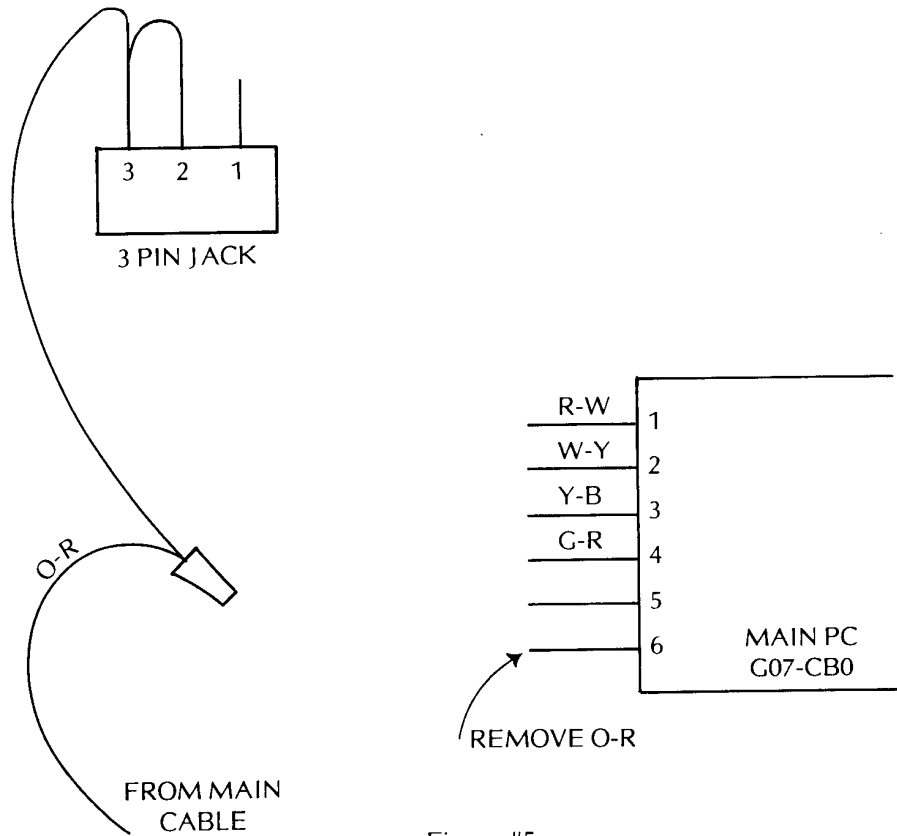

Figure #5

- NOTE:
1. The adaptor jack PCA080 - 91106 is used to eliminate wire changes in upright games.
  2. Not used in cocktail table games. (PCA080 - 91106).
  3. The orange - red must go to 3 pin jack as shown.

Andy Ducay  
Service Manager

AD/dc



**MIDWAY MFG. CO.**

A BALLY COMPANY

10750 W. GRAND AVENUE • FRANKLIN PARK, ILL. 60131

PHONE: AREA CODE 312 451-1360

CHICAGO PHONE: 992-2250

**SERVICE BULLETIN**

GAME: PAC-MAN, GORF AND RALLY-X

\*\*\*\*\*

1. PROPER VIDEO CABLE WIRE SEQUENCE FOR WELLS GARDNER  
COLOR MONITOR 19K4606

SEE FIGURE #1

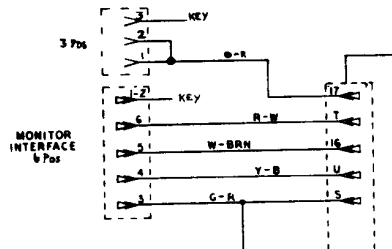

FIGURE #1

NOTE: PAC-MAN, GORF AND RALLY-X UPRIGHT GAMES CAN USE 19" ELECTROHOME OR WELLS GARDNER COLOR MONITORS.

MINI GAMES CAN USE THE G07-13 ELECTROHOME COLOR MONITOR.

ANDY DUCAY  
SERVICE MANAGER



**MIDWAY MFG. CO.**

A BALLY COMPANY

10750 W. GRAND AVENUE • FRANKLIN PARK, ILL. 60131

PHONE: AREA CODE 312 451-1360

CHICAGO PHONE: 992-2250

**SERVICE BULLETIN**

GAME: PAC-MAN, GORF AND RALLY-X

\*\*\*\*\*

1. PROPER VIDEO CABLE WIRE SEQUENCE FOR ELECTROHOME 19" COLOR MONITOR G07-CB0

SEE FIGURE #1

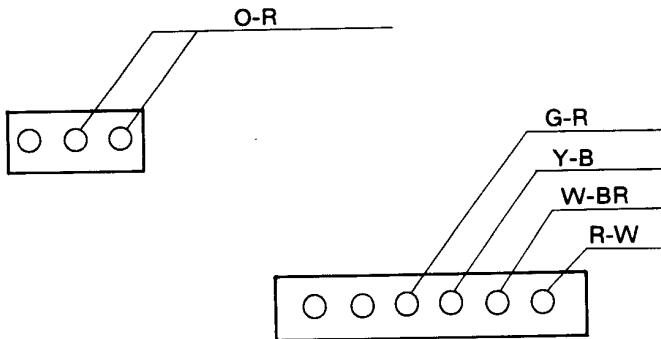

**FIGURE #1**

NOTE: PAC-MAN, GORF AND RALLY-X COCKTAIL TABLES USE ONLY ELECTROHOME MONITORS G07-CB0.

ANDY DUCAY  
SERVICE MANAGER

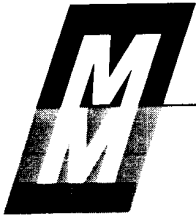

**MIDWAY MFG. CO.**

A BALLY COMPANY

10750 W. GRAND AVENUE • FRANKLIN PARK, ILL. 60131

PHONE: AREA CODE 312 451-1360

CHICAGO PHONE: 992-2250

April 14, 1980

**SERVICE BULLETIN**

GAME: Galaxian

SUBJECT: Wells Gardner 19 inch Color Monitor

\*\*\*\*\*

The four controls contrast, brightness, color and tint are not used. These controls are located in the upper right side of the monitor panel.

The brightness control is located on the interface P.C. Board. (85-X0134-001)

Andy Ducay  
Service Manager

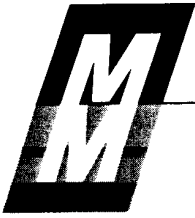

**MIDWAY MFG. CO.**

A BALLY COMPANY

10750 W. GRAND AVENUE • FRANKLIN PARK, ILL. 60131

PHONE: AREA CODE 312 451-1360

CHICAGO PHONE: 992-2250

July 1, 1980

### SERVICE BULLETIN

GAME: GALAXIAN  
SUBJECT: ELECTROHOME G0-2 COLOR MONITOR  
MODIFICATION: AS OF SERIAL NO. 20509

1. Due to a supply problem the 25 inch Electrohome monitor will now be used in upright games.
2. See figure #1 for additional and deleted parts.
3. The modification prevents using the 19 inch monitors as replacements.

Andy Ducay  
Service Manager

AD/bp

Figure #1

New Part No.	Name	Replaces Part No.	Comment
0866-00913-00XF	Display Glass.....	0866-00900-00XF.....	New Part uses the same blank glass.
0866-00912-0000	Tinted Plexi.....	0851-00904-0000	
0866-00507-0000	Cabinet.....	0866-00500-0000	
0866-00508-0000	Monitor Support 2 Req'd.....		Was not required on standard game
0866-00914-0000	Shield.....		Was not required on standard game.
A866-00094-0000	Monitor Brkt. Assy.....		Was not required on standard game.
0866-00127-0000 -0100	Side Mtg. Brkt. ....		Was not required on standard game.
0866-00128-0000	Back Shipping Brkt. ....		Was not required on standard game.
0866-00129-0000	Front Shipping Brkt. ....		Was not required on standard game.
0866-00130-0000	Support Brkt. ....		Was not required on standard game.

These parts will be deleted:

Part No.	Name
0866-00904-0000	T.V. Bezel
0866-00111-00XF	Monitor Shipping Brkt.
0866-00120-0000	Chassis Brace

These parts will continue to be used:

Part No.	Name
0866-00124-0000	Re-Inforcing Brkt. 2 Req'd.
0866-00126-00XF	Monitor Brkt. 2 Req'd.

NAME	Replaces Part Number	Quantity	New Part Number
25" Color Monitor	17-00003-0294	1	A866-00099-0000
2.5V R-G-B-Interface P.C. (Modified)	Not Used Before	1	A084-91304-B162
2.5V R-G-B-Interface Schematic	Not Used Before	1	M051-00866-A027
Galaxian Wiring Schematic	M051-0866-B003	1	M051-00866-C003
Low Voltage Cable Assy.	A866-00054-0000	1	A866-00096-0000
High Voltage Cable Assy.	A866-00051-0000	1	A866-00095-0000
Monitor Service Literature	Not Used Before	1	M051-00866-A024
TAG-"Modified 2.5V R-G-B Interface"	Not Used Before	1	M051-00866-A026
TAG-"Unit Supplied with 25" Monitor"	Not Used Before	1	M051-00866-A025

Delete: MT82 MT00-00082-0000



**MIDWAY MFG. CO.**

A BALLY COMPANY

10750 W. GRAND AVENUE • FRANKLIN PARK, ILL. 60131

PHONE: AREA CODE 312 451-1360

CHICAGO PHONE: 992-2250

February 11, 1980

### SERVICE BULLETIN

GAME: Galaxian

\*\*\*\*\*

#### MODIFICATION:

To bench test a Galaxian logic board with a black and white monitor, the following change must be made (see Figure #1):

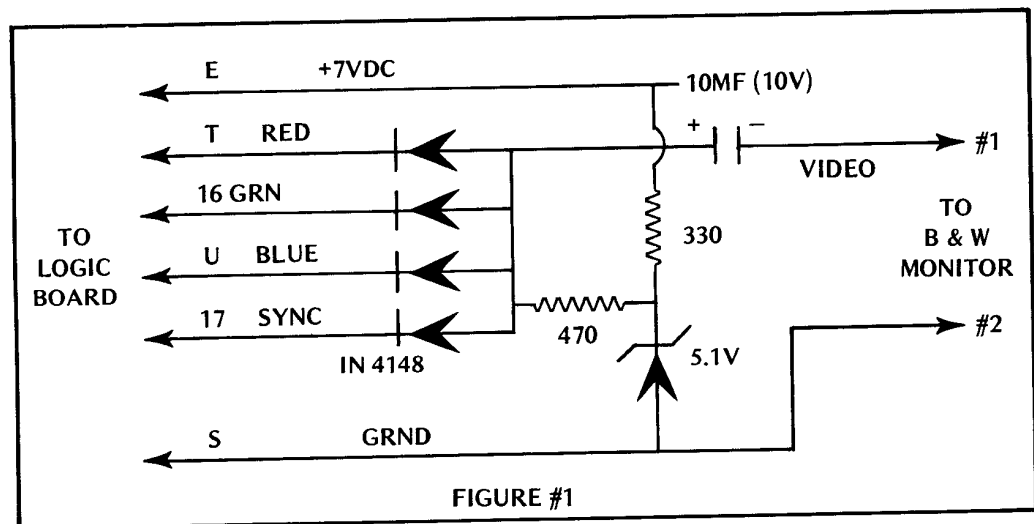

Note: The top and bottom may be slightly distorted due to horizontal synchronization.

Andy Ducay  
Service Manager

AD/jk

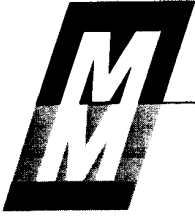

**MIDWAY MFG. CO.**

A BALLY COMPANY

10750 W. GRAND AVENUE • FRANKLIN PARK, ILL. 60131

PHONE: AREA CODE 312 451-1360

CHICAGO PHONE: 992-2250

July 30, 1980

**SERVICE BULLETIN**

GAME: EXTRA BASES

SUBJECT: BALL CONTROL UNIT PC A082-91323-E000

\*\*\*\*\*

MODIFICATION;

1. The Extra Bases Ball control PC A082-91323-E000 can be used on Shuffle Board or Bowling Alley without any modification.
2. The Shuffle Board and Bowling Alley Ball Control unit PC A082-91323-E000 can be used on Extra Bases with the following modification.
  - A. Change the two 51K resistors to 33K.
  - B. Change the two 270K resistors to 51K.
3. Check Electrically.

Andy Ducay  
Service Manager

AD/dc



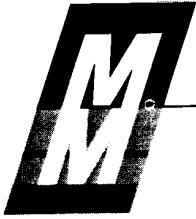

**MIDWAY MFG. CO.**

A BALLY COMPANY

10750 W. GRAND AVENUE • FRANKLIN PARK, ILL. 60131

PHONE: AREA CODE 312 451-1360

CHICAGO PHONE: 992-2250

July 1, 1980

**SERVICE BULLETIN**

GAME: EXTRA BASES

SUBJECT: Upright and Cocktail game Card Rack Ram Cards  
(PC A082 - 91356 - B000)

\*\*\*\*\*

NOTE FOLLOWING;

1. In all upright games the Ram card must be plugged into jack J-1. (J-2 is empty).
2. In all cocktail games we have two Ram cards which are plugged into jack J-1 and J-2. These Ram cards are interchangeable.

Andy Ducay  
Service Manager

AD/dc

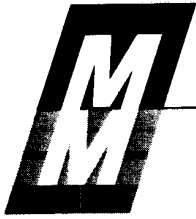

**MIDWAY MFG. CO.**  
A BALLY COMPANY  
10750 W. GRAND AVENUE • FRANKLIN PARK, ILL. 60131

PHONE: AREA CODE 312 451-1360  
CHICAGO PHONE: 992-2250

December 26, 1979

### SERVICE BULLETIN

GAME: Deluxe Space Invader

\*\*\*\*\*

#### ATTENTION:

A. For proper game operation in play mode, switch #2 must be in the "on" position. PC A082-90700-A000.

B. The record name feature can be tested, or the high score can be raised as follows:

#### HIGH SCORE AND NAME DISPLAY PROGRAM

1. Place switch #2 located on Game Logic Board (P.C. A082-90700-A000) in "OFF" position.
2. Close coin switch to display one credit on screen.
3. Depress One Player Select Button. "Preset Mode" will be displayed on screen.
4. Depress One Player Select Button again to increase score until previous Hi Score is beaten.
5. Depress Fire Button to start game. When all laser bases have been destroyed, the alphabet will be displayed on the screen. A new name may now be programmed on the screen as indicated by instructions on Control Panel.
6. Place switch #2 located on Game Logic Board (P.C. A082-90700-A000) in "ON" position to reestablish game mode.

Note: To reset Hi-Score (to 5000) and Name Display, depress "ON-OFF" switch.

AD:jk

Andy Ducay  
Service Manager



**MIDWAY MFG. CO.**

A BALLY COMPANY  
10750 W. GRAND AVENUE • FRANKLIN PARK, ILL. 60131

PHONE: AREA CODE 312 451-1360

CHICAGO PHONE: 992-2250

April 14, 1980

**SERVICE BULLETIN**

GAME: Space Invaders Deluxe

SUBJECT: Game Board Auxiliary, PC A080-91366-A000

\*\*\*\*\*

1. Due to a supply problem, we are temporarily out of the Custom I.C. MB14241 on the Game Board PC A082-90700-A000.
2. The plug in Auxiliary PC Board will be used until the Custom bit shifter is available again.
3. The Auxiliary PC Board has 4 - 25S10 bit shifters and 4 - 74175 latches.

Andy Ducay  
Service Manager



**MIDWAY MFG. CO.**

A BALLY COMPANY

10750 W. GRAND AVENUE • FRANKLIN PARK, ILL. 60131

PHONE: AREA CODE 312 451-1360

CHICAGO PHONE: 992-2250

May 16, 1980

**SERVICE BULLETIN**

GAME: Space Invaders Deluxe

SUBJECT: Proms and Roms

\*\*\*\*\*

1. Due to a supply problem the Invader program may be all 2716 Proms or all 9316 Roms.
2. On occasion the Invader program will be a mixture 2716 Proms (single supply) and 9316 Roms. The 2716 Proms will have pin #21 cut with a jumper wire between pin #21 and pin #24.
3. When all 2716 Proms are single supply type the Mother Board Strapping is different from 9316 and 2716 multiple type.

Andy Ducay  
Service Manager

AD/dc



**MIDWAY MFG. CO.**

A BALLY COMPANY

10750 W. GRAND AVENUE • FRANKLIN PARK, ILL. 60131

PHONE: AREA CODE 312 451-1360

CHICAGO PHONE: 992-2250

**SERVICE BULLETIN**

GAMES: 18 Wheeler, Bowling Alley, Space Invaders and  
Blue Shark

SUBJECT: Prom and Rom Identification

\*\*\*\*\*

1. The game number will identify which game Proms and Roms belong to,  
as listed below:

18 Wheeler M-653-H  
Bowling Alley M-730-H  
Space Invaders M-739-H  
Blue Shark M-742-H

Midway-Game-Locations

NOTE: The game number of each game can be found on the cover of the  
parts catalog.

Andrew Ducay  
Service Department

AD:dc  
07/2/79

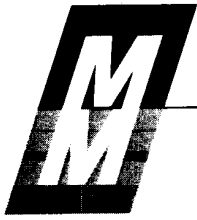

**MIDWAY MFG. CO.**

A BALLY COMPANY

10750 W. GRAND AVENUE • FRANKLIN PARK, ILL. 60131

PHONE: AREA CODE 312 451-1360

CHICAGO PHONE: 992-2250

### SERVICE BULLETIN

GAME: Space Invaders (Up-right and cocktail table)

SUBJECT: Prevent random garbage and extra credit condition

\*\*\*\*\*

#### MODIFICATION:

1. All A084-90700-739-D game boards have three capacitors which are not grounded (RRC Network).
2. Refer to Figure #1 for the location of 1.0MF-25V capacitors.
3. On rear side of game logic board, solder jumber wires from negative side of capacitor to ground (See Figure #1).
4. Check coin and control circuits electrically.

Andrew Ducay  
Service Manager

AD/r  
07/16/79





**MIDWAY MFG. CO.**

A BALLY COMPANY

10750 W. GRAND AVENUE • FRANKLIN PARK, ILL. 60131

PHONE: AREA CODE 312 451-1360

CHICAGO PHONE: 992-2250

February 13, 1980

**SERVICE BULLETIN**

GAME: Space Invaders

CONDITION: Garbage Lines In Video and Extra Credit

\*\*\*\*\*

**POSSIBLE REMEDY**

1. Check game board for proper RRC capacitor grounding. (P.C. A804-90700-D739).
2. Clean game board edge connector and inspect Mother board 72 pin connector.
3. Measure +5, +12 and -5 voltages at edge connector of Mother board. Adjust voltages using pots on Power Supply.
4. Replace possible heat sensitive TI-8080 CPU with 7919 date code.
5. Add a Cor-Com line filter. (0017-00003-0114)
6. Inspect soldering of bit shifters on game board. (25S10 or 74151)

Andy Ducay  
Service Manager

AD:jk





**MIDWAY MFG. CO.**

A BALLY COMPANY

10750 W. GRAND AVENUE • FRANKLIN PARK, ILL. 60131

PHONE: AREA CODE 312 451-1360

CHICAGO PHONE: 992-2250

May 14, 1979

SERVICE BULLETIN

GAME: Space Invaders Upright and  
Cocktail Table

SUBJECT: Dip Switch Settings, Game Logic  
Board (PC-A084-90700-739)

\*\*\*\*\*

1. Upright Games

A. Switches 5, 6, 7 and 8 must be in on position.

2. Cocktail Table

A. Switches 5, 6, 7 and 8 must be in off position.

Andy Ducay  
Service Manager

AD:jk



**MIDWAY MFG. CO.**

A BALLY COMPANY  
10750 W. GRAND AVENUE • FRANKLIN PARK, ILL. 60131

PHONE: AREA CODE 312 451-1360

CHICAGO PHONE: 992-2250

December 11, 1978

SERVICE BULLETIN

GAME: Space Invaders

SUBJECT: Game Logic Board

\*\*\*\*\*

MODIFICATION:

1. Due to a supply problem the 25S10 shifter I.C.'s have been replaced with 74151 data selector multiplexers.
2. Game logic board P.C. A084-90700-B000 have four 25S10 I.C.'s.
3. Game logic board P.C. A084-90700-C00 have eight 74151 I.C.'s.

Andy Ducay  
Service Manager

AD:jk

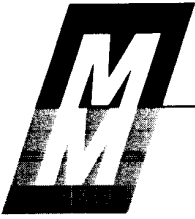

**MIDWAY MFG. CO.**

A BALLY COMPANY

10750 W. GRAND AVENUE • FRANKLIN PARK, ILL. 60131

PHONE: AREA CODE 312 451-1360

CHICAGO PHONE: 992-2250

## SERVICE BULLETIN

GAME: Submarine

\*\*\*\*\*

### ATTENTION:

The target ship explosion light zero switch and sink target ship zero switch must be closed for proper game operation. If either switch is open, dirty contacts or loose cam set screws the coin counter will pulse and the game will stay in the game over mode.

Andy Ducay  
Service Manager

AD:jk  
11/26/79

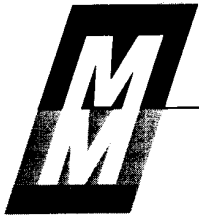

**MIDWAY MFG. CO.**

A BALLY COMPANY

10750 W. GRAND AVENUE • FRANKLIN PARK, ILL. 60131

PHONE: AREA CODE 312 451-1360

CHICAGO PHONE: 992-2250

### SERVICE BULLETIN

GAME: 18 Wheeler

CONDITION: Premature Game Over (games serial #101 to 300)

\*\*\*\*\*

#### MODIFICATION:

1. Solder 0.1 MFD disc capacitor to the mother board PC A082-90400-B000, location J-4. (See Figure #1)
2. Check out game electrically.

Andrew Ducay  
Service Manager

AD/r  
07/27/79

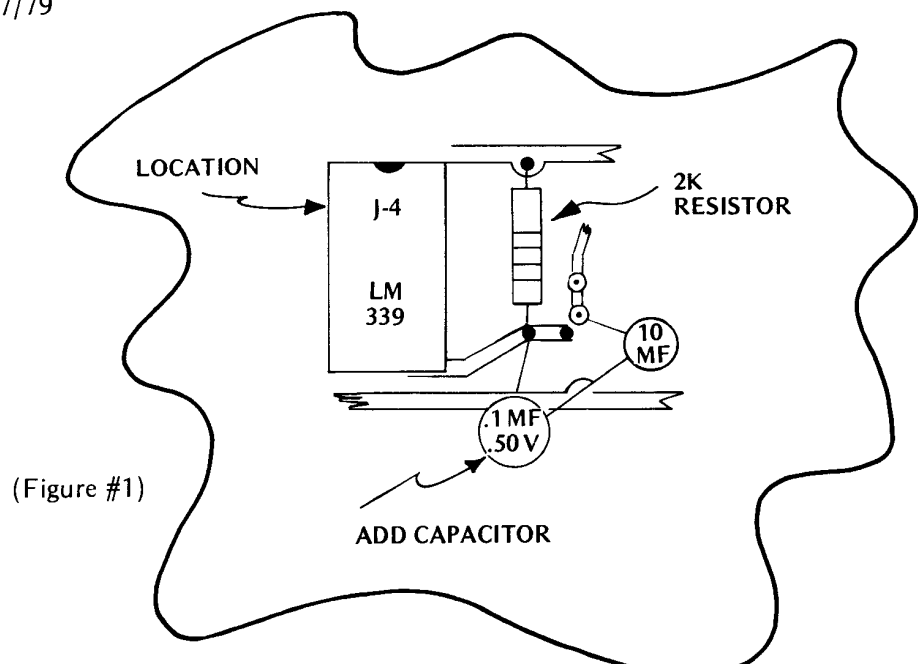

(Figure #1)



**MIDWAY MFG. CO.**

A BALLY COMPANY

10750 W. GRAND AVENUE • FRANKLIN PARK, ILL. 60131

PHONE: AREA CODE 312 451-1360

CHICAGO PHONE: 992-2250

" 18 W H E E L E R " BACK DOOR REWORK

TO IMPROVE CABINET VENTING

CUT OUT VENT  
AREA RIBS AS  
SHOWN

RE-MOUNT EXISTING VENTS  
FLUSH WITH 6 x 1/2 SCREW  
(0017-00101-0014)

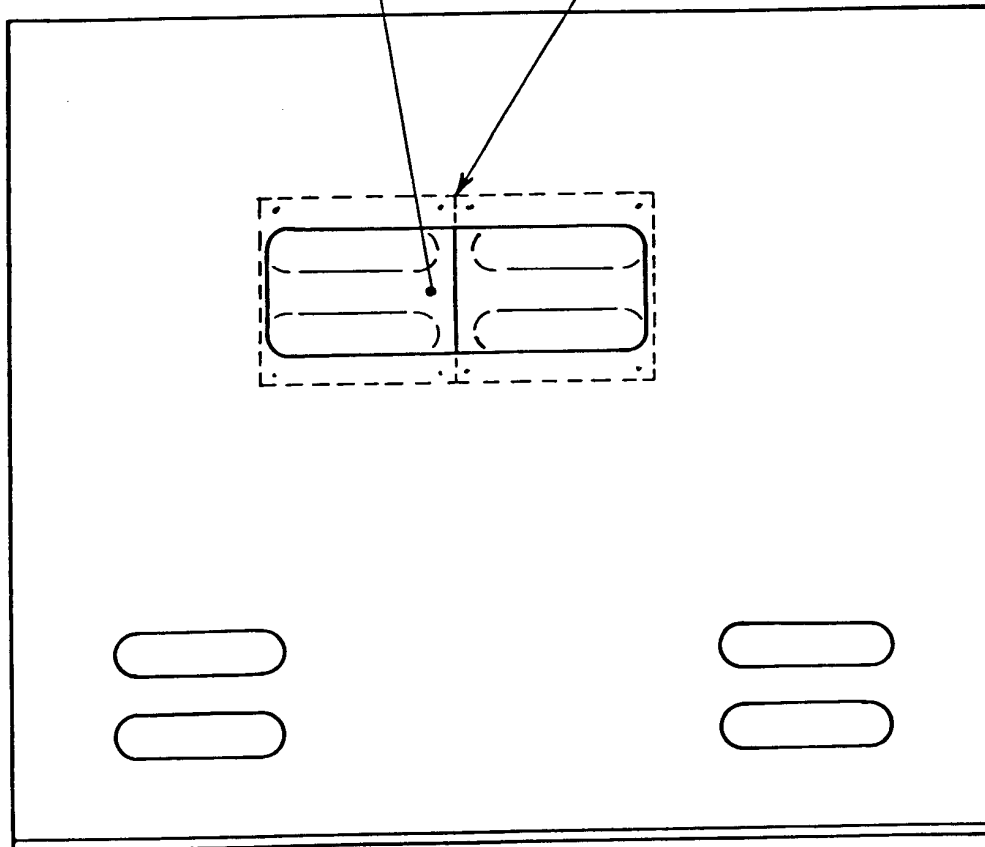

## "18 WHEELER" PROJECTOR FAN REWORK

### Installation Instructions

1. Remove 6 screws holding projector light shroud to pan and hub assembly.
2. Remove old fan and platform.
3. Assemble bracket (Item 1) to new exhaust fan (Item 2) as shown using self threading screws (Item 3).
4. This assembly gets fastened using the same holes and screws as the old fan platform.
5. Drill 2, 3/16 dia. holes in bottom of shroud as per dimensions on shroud rework detail.
6. Replace projector light shroud by first assembling 2 self threading screws through fan shroud to the fan mounting bracket (Item 1) and then the 6 remaining screws through the shroud to the pan and hub assembly.

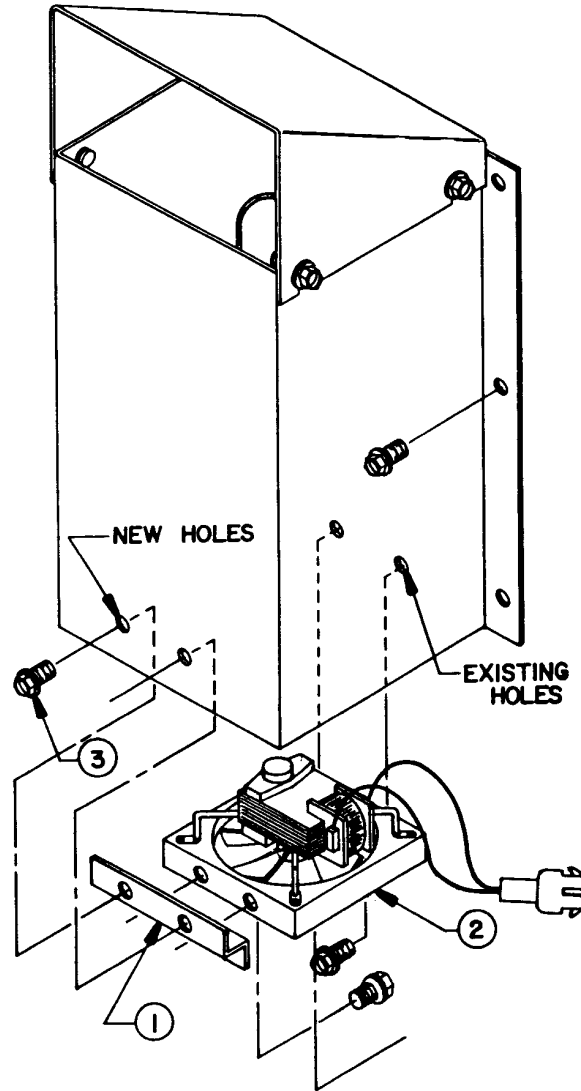

### KIT PARTS LIST CONSIST OF

<u>Item</u>	<u>Description</u>	<u>Part No.</u>	<u>Qty.</u>
1	Bracket	0653-00191-0000	1
2	Exhaust Fan Assy.	A653-00074-0598	1
3	#8-32x5/16 Sl. Hex. Hd. Mach. Screw	0017-00101-0598	4

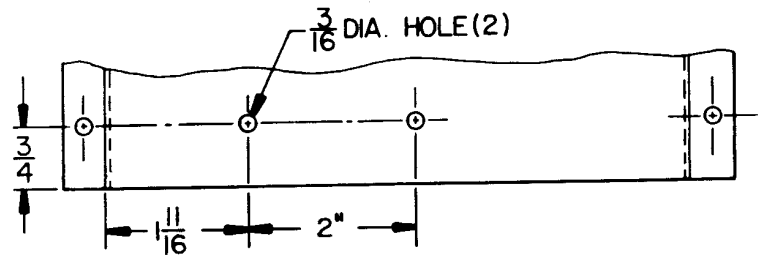

**SHROUD REWORK DETAIL**

M051-00653-A028

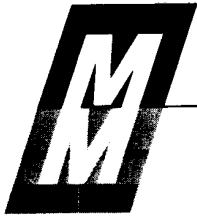

**MIDWAY MFG. CO.**

A BALLY COMPANY

10750 W. GRAND AVENUE • FRANKLIN PARK, ILL. 60131

PHONE: AREA CODE 312 451-1360

CHICAGO PHONE: 992-2250

February 11, 1980

**SERVICE BULLETIN**

GAME: Super Speed Race and Sea Wolf II

CONDITION: Reversed Image on G0-2 Color Monitor (25'')

\*\*\*\*\*

Both Super Speed Race and Sea Wolf II use the Electrohome G0-2 color monitor. In Sea Wolf II a mirror reverses the image from the monitor, but in Super Speed Race the monitor is viewed directly.

If the monitor in either game is changed and the image comes up backwards, switch the yellow and green wires at pins #1 and #2 on the round male connector coming from the yoke assembly to the geometry PCB #82-230010-05.

Pin #1 should be yellow and pin #2 green for "direct" viewing.

Bob Norton  
Service Technician

BN:jk



**MIDWAY MFG. CO.**

A BALLY COMPANY

10750 W. GRAND AVENUE • FRANKLIN PARK, ILL. 60131

PHONE: AREA CODE 312 451-1360

CHICAGO PHONE: 992-2250

### SERVICE BULLETIN

GAME: SEAWOLF II, EXTRA BASES, SPACE ZAP & GORF

SUBJECT: Custom chip identification (I/O, Address, and Data)

\*\*\*\*\*

The following numbers will identify the special custom chips used in Seawolf II mother board (PC 084-90002-B-625):

I/O .....2720 or 0066-117XX

Address .....2719 or 0066-115XX

Data ..... 2721 or 0066-116XX or 2860

Andrew Duca  
Service Manager

AD/r  
07/10/79





**MIDWAY MFG. CO.**

A BALLY COMPANY

10750 W. GRAND AVENUE • FRANKLIN PARK, ILL. 60131

PHONE: AREA CODE 312 451-1360

CHICAGO PHONE: 992-2250

SERVICE BULLETIN

SEAWOLF II

ELECTROHOME COLOR MONITOR (25'')

**SYMPTOM:** TV loses anode voltage, 30,000 VDC approximately, after 5 or 6 seconds.

**CAUSE:** On the Electrohome color monitor, the high voltage is protected by an overvoltage protection circuit. This circuit is probably too sensitive, or the 125 volt DC power supply is faulty.

**SOLUTION:** First determine if 125 volts DC is available on the power supply PCB. C940 could make it more sensitive if it has excessive leakage. Check R928B 680k .5 watt. If it's missing or clipped out, replace it. If R928B 680k is being used, change this resistor to one with a value of 510k .5 watt. If it is still too sensitive, change resistor to 470k .5 watt.

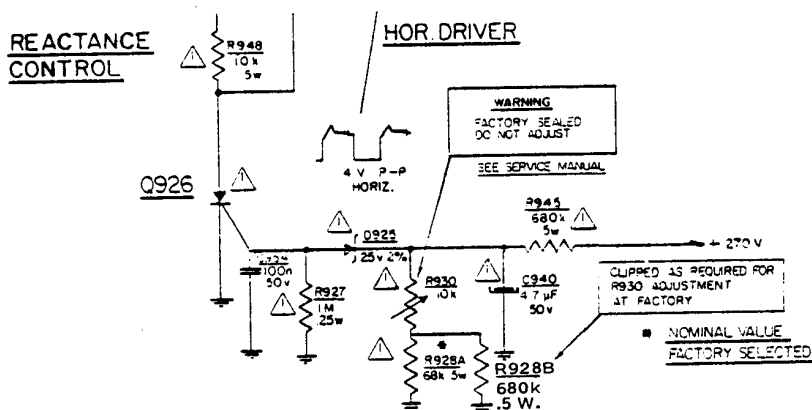

Andy Ducay  
Service Manager

AD:ih  
05/78

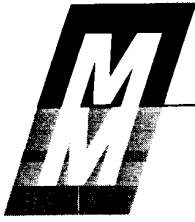

**MIDWAY MFG. CO.**

A BALLY COMPANY

10750 W. GRAND AVENUE • FRANKLIN PARK, ILL. 60131

PHONE: AREA CODE 312 451-1360

CHICAGO PHONE: 992-2250

### SERVICE BULLETIN

GAME: Rotation VIII

CONDITION: Power reset failure when turning game on causing coils to pulse or stay energized.

\*\*\*\*\*

#### MODIFICATION:

1. Replace the 2.7 volt zener in power reset circuit with a 7.5 volt zener.
2. Cut trace at pin 4 LM339 location A2-3. (See Fig. 1)
3. Solder a 1K resistor from pin 4 LM339 to the cathode of the 7.5 volt zener. (See Fig. 1)
4. Solder a IN4148 diode from pin 4 LM339 to ground (pin 12 LM339).
5. Check game out electrically.

Andrew Ducay  
Service Manager

AD:jk  
05/3/79

POWER RESET MODIFICATION  
ROTATION VIII

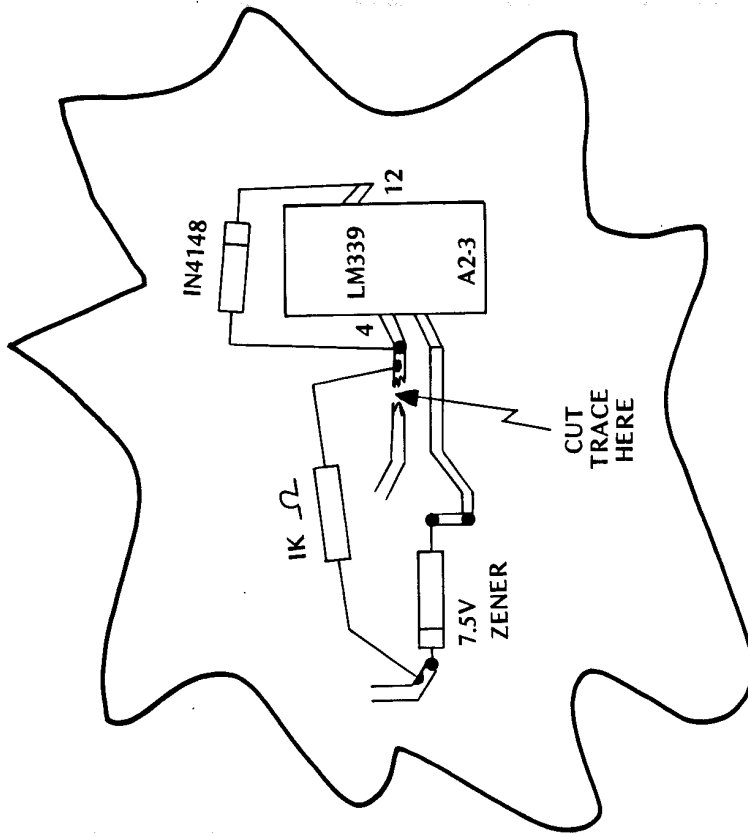
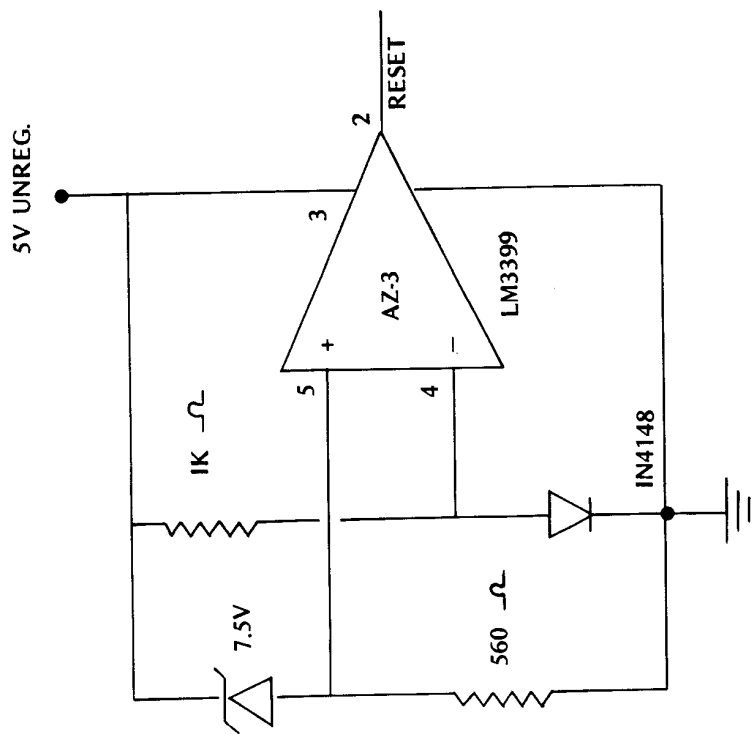

FIG. #1



**MIDWAY MFG. CO.**

A BALLY COMPANY

10750 W. GRAND AVENUE • FRANKLIN PARK, ILL. 60131

PHONE: AREA CODE 312 451-1360

CHICAGO PHONE: 992-2250

December 21, 1978

**SERVICE BULLETIN**

GAME:           Rotation VIII

SUBJECT:        Logic Board A084-91313-G627 (Sound)

\*\*\*\*\*

When changing from an "F" board to a "G" board, cut the orange or yellow-green wire at power supply jack "C" pin #6. (Prevents damage to amplifier I. C. LM 377.)

Andy Ducay  
Service Manager

Note: When changing from a "G" board to an "F" board, the orange or yellow-green wire must be connected at "C" jack, pin #6. (For proper sound.)

AD:jk

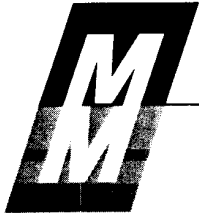

**MIDWAY MFG. CO.**

A BALLY COMPANY

10750 W. GRAND AVENUE • FRANKLIN PARK, ILL. 60131

PHONE: AREA CODE 312 451-1360

CHICAGO PHONE: 992-2250

SERVICE BULLETIN

GAME: Bowling Alley

SUBJECT: Rams, Proms and Roms

\*\*\*\*\*

The BOWLING ALLEY game microprocessor system has been programmed to detect a defective Ram, Prom and/or Rom. To utilize the test, proceed as follows:

1. Set switch #8 to on position (A084-90700-C730).
2. Activate coin door tilt switch.
3. The Ram test sequence will scan and vertical lines will appear.
4. When all Rams are good, the scan will be continuous.
5. When a Ram is defective, dark vertical columns will appear (refer to Figure #1 for method of locating a bad Ram).
6. When Ram test is completed and all Rams are good, the T.V. screen will blank out to indicate a bad Prom or Rom by displaying letters locating it.
7. When Proms and Roms are good, the Ram scan will be continuous.
8. Return switch #8 to off position (A084-90700-C730).
9. The Ram scan will stop and game will return to normal when the tilt switch is activated.

NOTE: Rams must be good before Prom and Rom test can be made.

Andy Ducay  
Service Manager

AD:jk  
3/2/79

# SERVICE BULLETIN

GAME: Bowling Alley

SUBJECT: Figure One – Method of Locating a Bad RAM

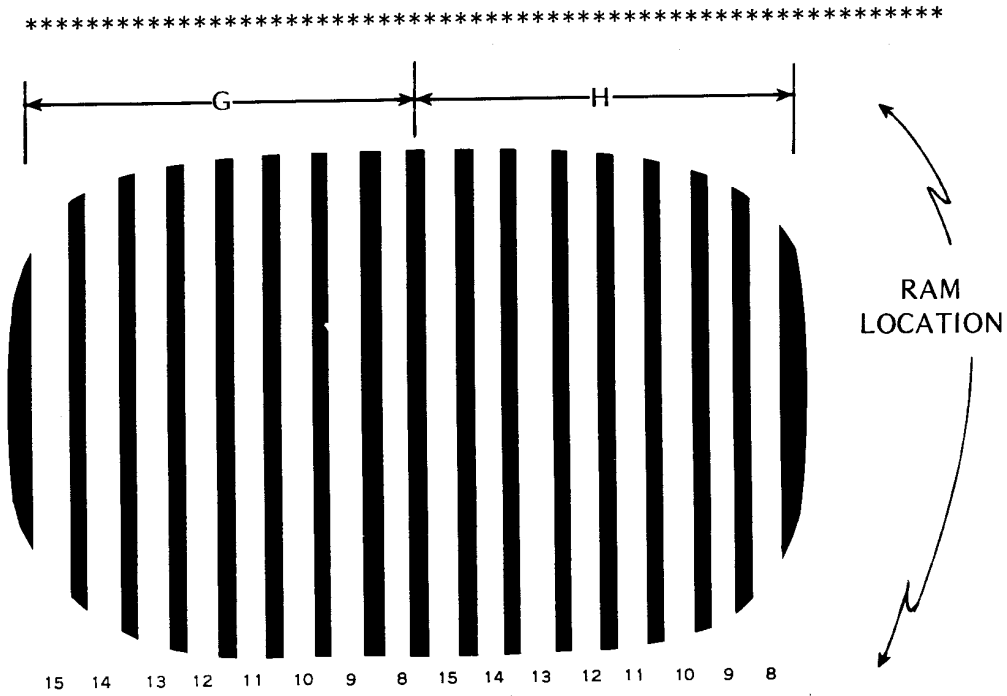

1. When one or more columns are missing or altered, this would indicate a RAM problem.
2. Use Figure One TV display to determine location of faulty RAMs.

AD/r  
12/27/77

# MOTHER BOARD

80-900 H & K

2716 PROMS  
9316 ROMS

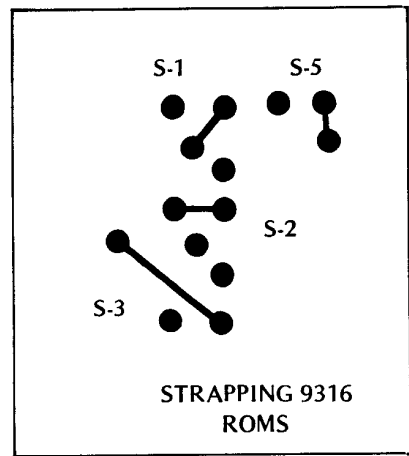
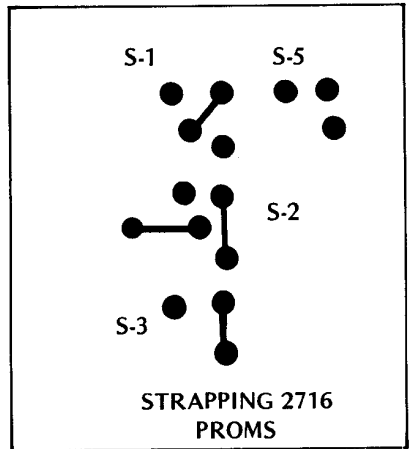
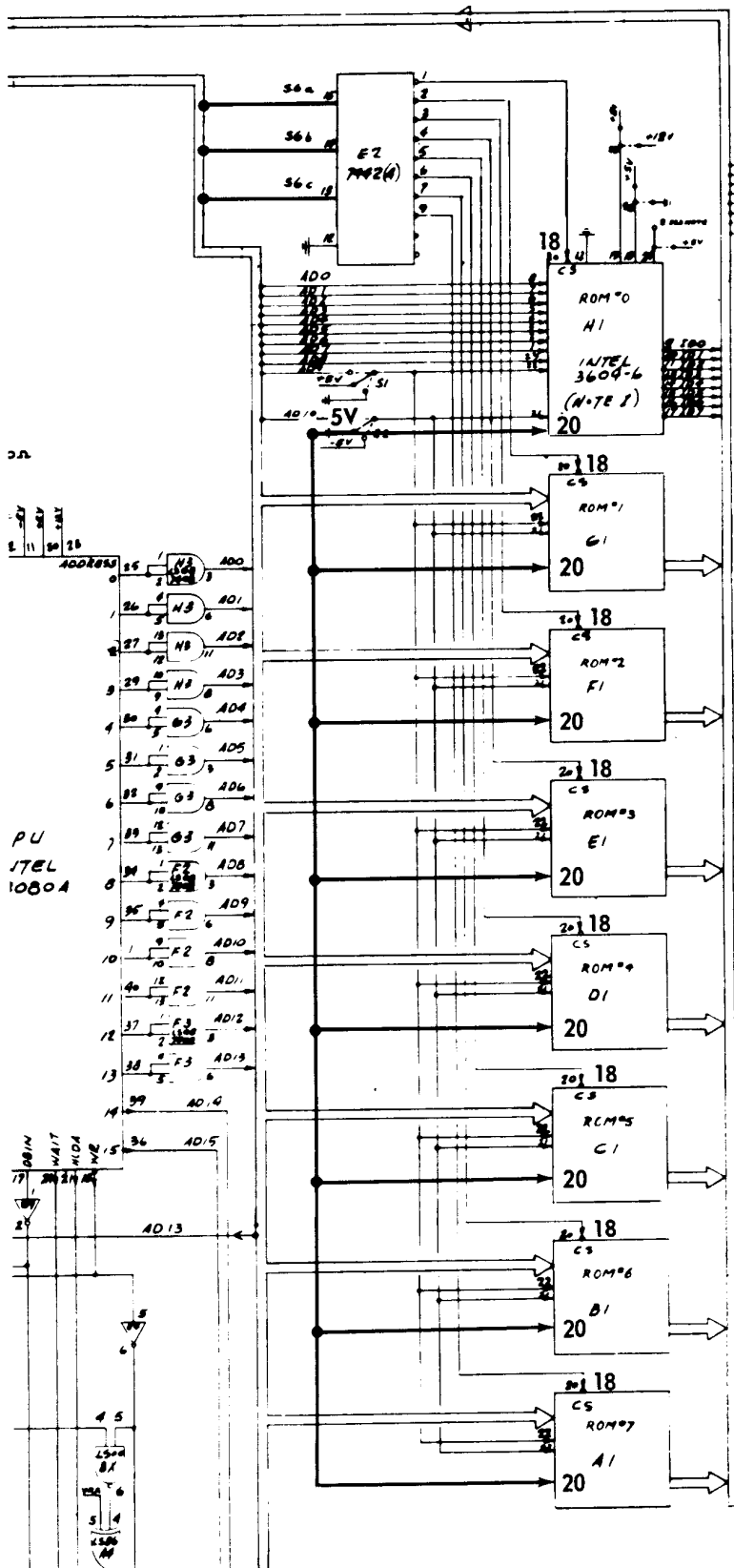



**MIDWAY MFG. CO.**

A BALLY COMPANY

10750 W. GRAND AVENUE • FRANKLIN PARK, ILL. 60131

PHONE: AREA CODE 312 451-1360

CHICAGO PHONE: 992-2250

October 13, 1980

**SERVICE BULLETIN**

GAME: SEA WOLF I. 280Z. GUIDED MISSILE, LAGUNA RACER

SUBJECT: 8516 & 2716 Prom Strapping Information (16K)

1. Refer to figure #1 for proper strapping of jumpers and capacitor removing or relocating.
2. Cut pins #18 and #20 of each prom and jumper as shown in figure #2.
3. Check electrically.

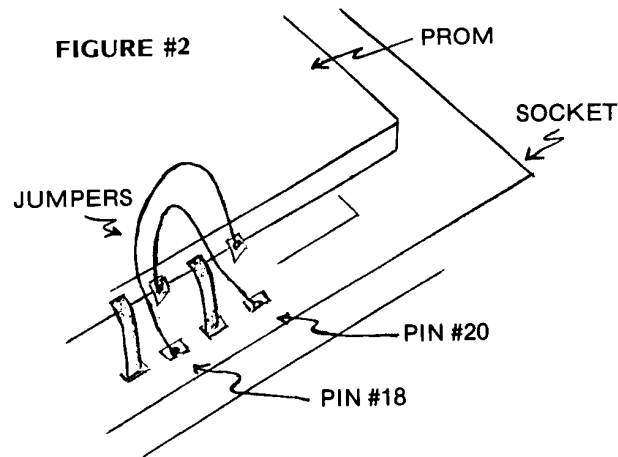

Andy Ducay  
Service Manager

**REVERSE PIN #18 & 20 AS SHOWN**





**MIDWAY MFG. CO.**

A BALLY COMPANY

10750 W. GRAND AVENUE • FRANKLIN PARK, ILL. 60131

PHONE: AREA CODE 312 451-1360

CHICAGO PHONE: 992-2250

## SERVICE BULLETIN

GAMES:            Gun Fight  
                      Sea Wolf  
                      Tornado Baseball

SUBJECT:          Power Supply P.C. 80-904

What may look like a logic problem may be a power supply failure.

Check the following:

- (1) +5V, -5V, and +12V.
- (2) The 24 pin jack for defective wiring or pin connectors (female and male).
- (3) Cold solder connections, capacitors, diodes, resistors, and transistors, (rear side).
- (4) Damaged printed circuit traces.
- (5) Loose parts on heat sink.
- (6) Make repairs and check game out electrically.

AD:r  
09/30/76



**MIDWAY MFG. CO.**

A BALLY COMPANY

10750 W. GRAND AVENUE • FRANKLIN PARK, ILL. 60131

PHONE: AREA CODE 312 451-1360

CHICAGO PHONE: 992-2250

## SERVICE BULLETIN

GAMES: Gun Fight, Sea Wolf, and Tornado Baseball

CONDITION: Random errors appearing on TV screen.

1. Garbage
2. Lock-up condition
3. False ram scan (Tornado Baseball)

MODIFICATION: Add two .01 MFD capacitors to the mother board, PC 80-900; reset circuit (CPU) as shown below.

1. Solder .01 MFD capacitor between pin #10 and ground (-5 volts).
2. Solder .01 MFD capacitor between pin #10 and +5 volts (VCC).

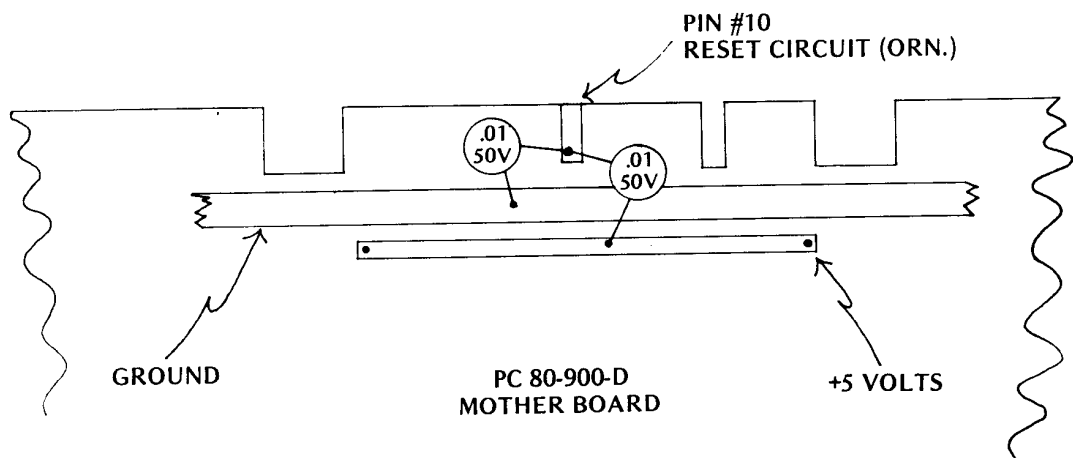

AD:r  
10/05/76

MOTOROLA MONITOR M 7000-155

YOKE WIRING

NOTE!  
 NO CHANGE  
 GUN FIGHT  
 CHECK MATE  
 CLOWNS  
 ALL TABLES

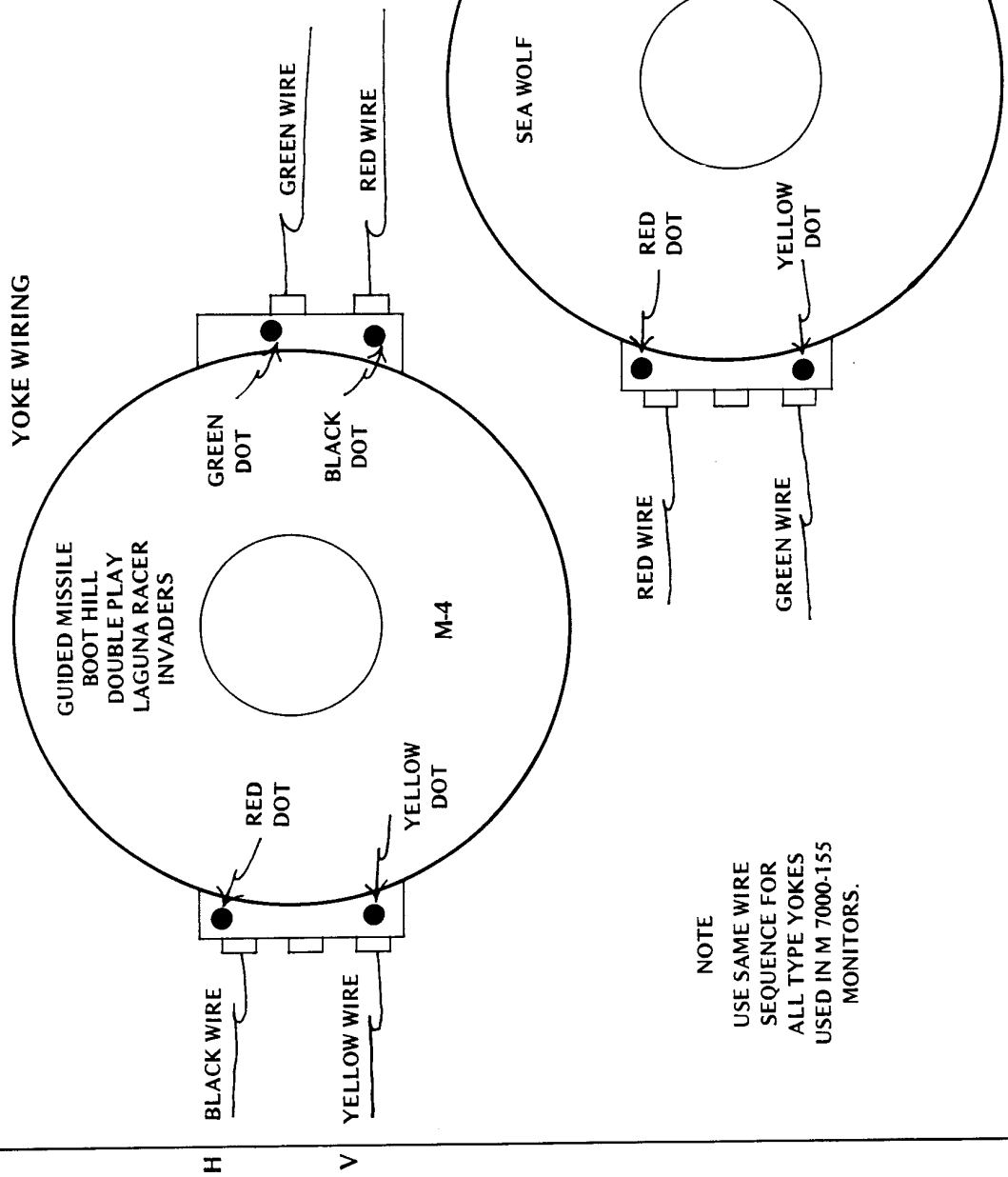

MOTOROLA MONITOR M 7000-155

YOKE WIRING

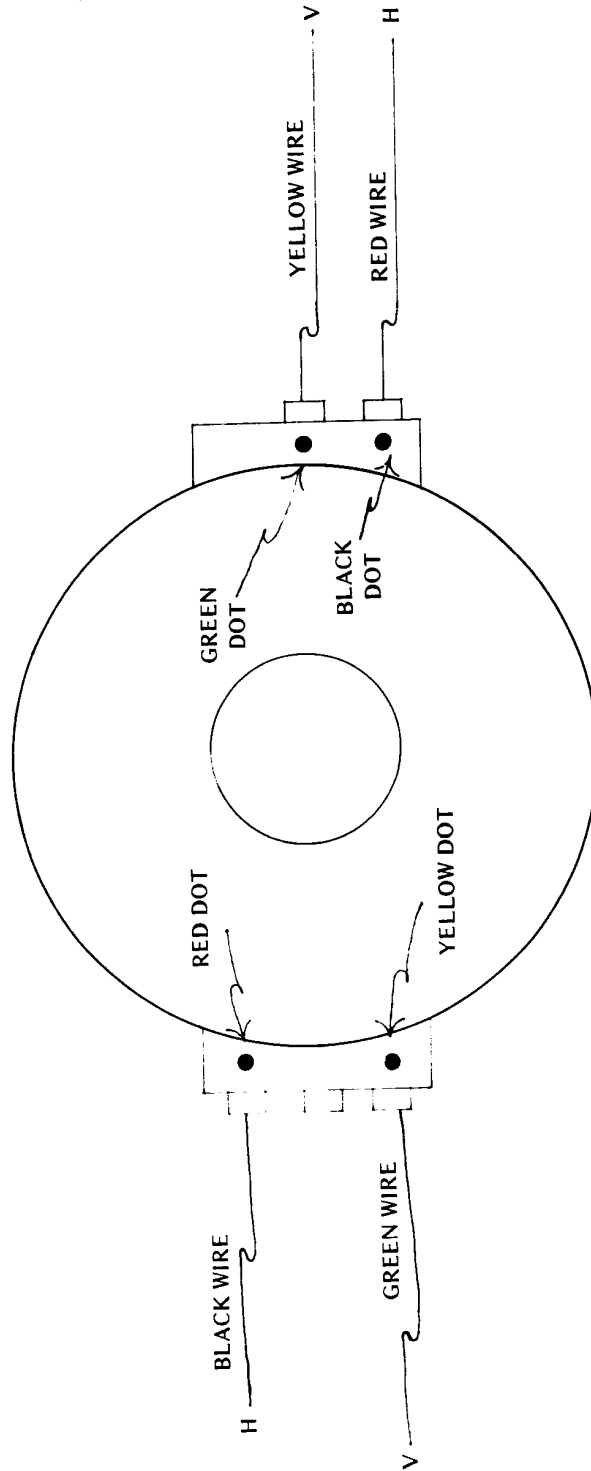

NOTE  
USE SAME WIRE  
SEQUENCE FOR  
ALL TYPE YOKES  
USE IN M 7000-155  
MONITORS.

ROAD RUNNER  
DESERT GUN

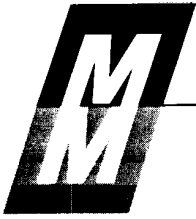

**MIDWAY MFG. CO.**

A BALLY COMPANY

10750 W. GRAND AVENUE • FRANKLIN PARK, ILL. 60131

PHONE: AREA CODE 312 451-1360

CHICAGO PHONE: 992-2250

MONITOR MANUFACTURERS

MOTOROLA INC.

Display Products

455 East North Avenue

Carol Stream, Illinois 60187

Telephone: (312) 231-4400

Chris Petri, Product Service Manager

WELLS GARDNER ELECTRONICS CORP.

2701 North Kildare Avenue

Chicago, Illinois 60639

Telephone: (312) 252-8220

Norm Schumacker, Service

ELECTROHOME LIMITED

809 Wellington St. N.

Kitchener, Ont. N2G 4J6

Telephone: (519) 744-7111

Tom Van Gink, Program Co-Ordinator

## Glossary of Computer Terms

**Silicon Valley** - The region around Sunnyvale, California (south of San Francisco) is known as the birthplace and present capital of the microprocessor. Fairchild Instrument is considered as the pioneer company in this area with most of their engineers leaving and branching out to form competing companies such as Intel and Zilog.

**Hardware** - The physical components of a system. i.e. transistors, capacitors, microprocessor, data chip, input-output chip, address chip.

**Software** - Can be best defined as the program, whether it be resident permanently as a fixed set of instructions as in ROM or inputted as data by the user.

**Bit** - A word is one logical unit of information consisting of 4, 8, 12 or 16 bit (a bit is a binary digit, either 1 or 0, high or low). An 8 bit microprocessor requires 8 bits of data and the word size for an 8 bit microprocessor is therefore 8 bits.

**Byte** - Eight bits are called a byte.

**Memory** - That part of a system which is used to store both the programs which will execute on the processor, and the data which will be manipulated by the system.

**ROM** - Read Only Memory is a device that has data permanently entered into it to be outputted on demand, a fixed set of instructions.

**RAM** - Random Access Memory is a type of memory in which any byte can be accessed (that is, written into or read from) after any other byte. The random access capability of RAM makes it easier to use, and allows much faster operation.

**Address** - The position or location of the word within the memory is called its address.

**LSI technology** - Large Scale Integration technology allows the implementing of 1 to 15,000 transistors on a single chip.

**CPU** - The CPU (central processing unit) is basically a microprocessor. The CPU is divided into two units, the ALU (arithmetic logical unit) and the CU (control unit). The function of the ALU is to perform arithmetic and logical operations on data passing through it. The CU will sequence the operation of the entire system. The control unit fetches, decodes and executes successive instructions stored in the memory system.

**Microprocessor** - An LSI component which implements the functions of an arithmetic-logical-unit plus its associated control unit in a single chip.

**Register** - A fundamental unit inside a microprocessor which is a specialized memory. It can be thought of as a blackboard where data is written so it can be easily accessed and changed. Registers usually contain the data the processor is currently working on. Generally, microprocessors with more registers are more powerful and easier to program to do a given job.

**Intel 8080** - First off-shoot of the 8008. This machine inspired the development of most microprocessors today, such as the Motorola 6800, Rockwell PPS8, Signetics 2650, and the Zilog Z-80. The 8080 is a general purpose middle of the road microprocessor. Its instruction set and other characteristics are good examples of microprocessors in general, being neither extremely simplified, nor extremely powerful, nor particularly unusual.

**Motorola 6800** - A machine that was introduced as direct competition to the Intel 8080. The 6800 has two apparent advantages to the 8080, it requires only one voltage level to operate as compared to the three needed by the 8080, hence a more simplified power supply is needed. Secondly, the 6800 has an additional two pins.

**F-8 (by Fairchild)** - This microprocessor is designed for specialized applications where the microprocessor is permanently incorporated as part of a specific piece of equipment unrelated to computing. This microprocessor is known for the large amount of supporting circuitry and devices it needs for operation.

**Zilog** - Designers of the Z-80. This microprocessor was developed by many of the men who designed the Intel 8080. This device is probably the first case where experienced microprocessor designers, after having seen the results of their work used in practical applications, designed a new general purpose microprocessor.

The Z-80 executes 158 different instructions, which increase to 696 operation codes, compared to 78 instructions and 244 operation codes for the 8080A (the first version of the 8080).