

Matsushita 19-Inch Color Raster Display

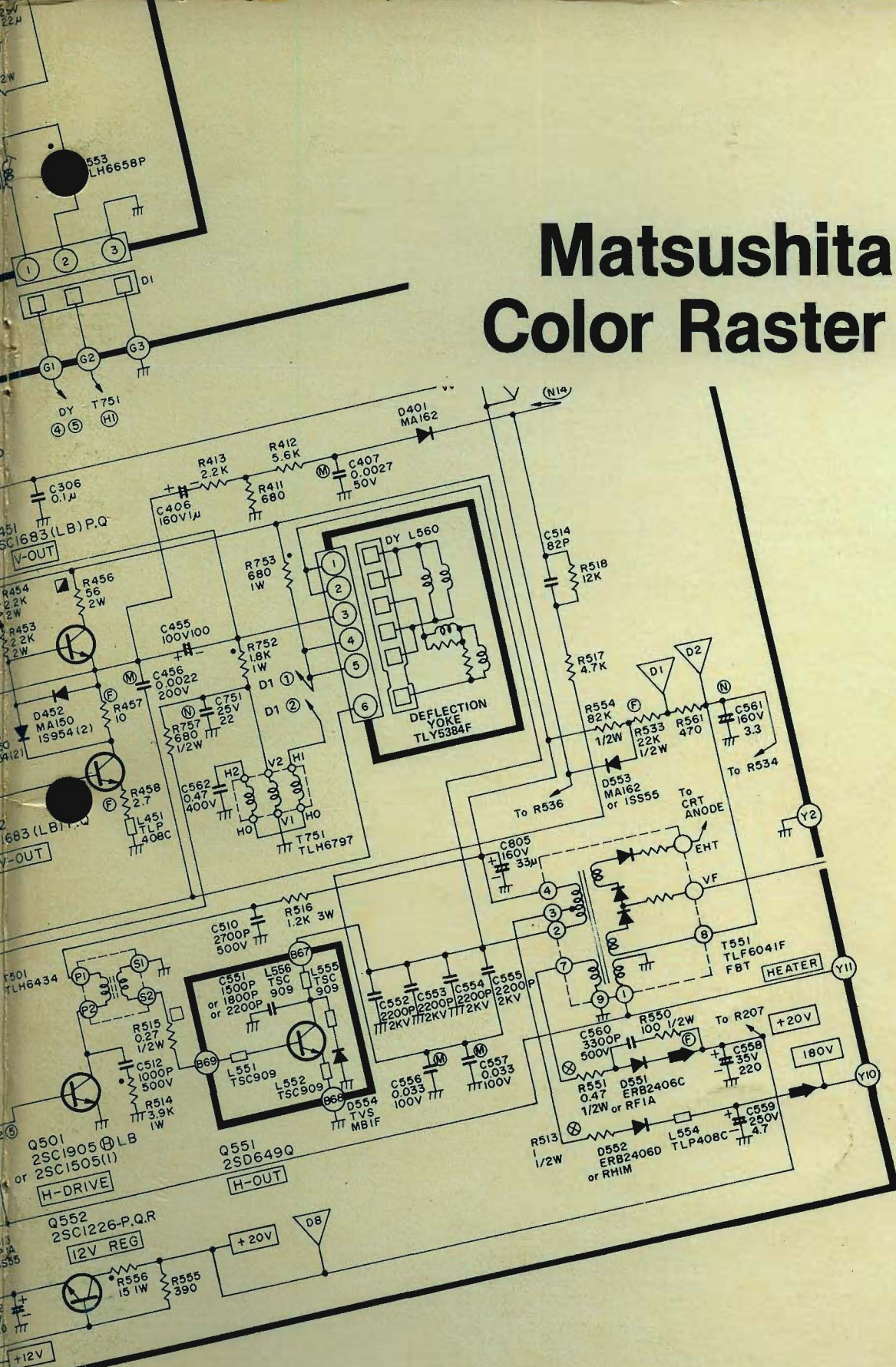

A Warner Communications Company

Service Manual

Complete with Schematic and Illustrated Parts Lists

Warranty

Seller warrants that its printed-circuit boards and parts thereon are free from defects in material and workmanship under normal use and service for a period of ninety (90) days from date of shipment. Seller warrants that its video displays (in games supplied with displays) are free from defects in material and workmanship under normal use and service for a period of thirty (30) days from date of shipment. None of the Seller's other products or parts thereof are warranted.

If the products described in this manual fail to conform to this warranty, Sellers' sole liability shall be, at its option, to repair, replace, or credit Buyer's account for such products which are returned to Seller during said warranty period, provided:

- (a) Seller is promptly notified in writing upon discovery by Buyer that said products are defective;
- (b) Such products are returned prepaid to Sellers' plant; and
- (c) Seller's examination of said products discloses to Seller's satisfaction that such alleged defects existed and were not caused by accident, misuse, neglect, alteration, improper repair, installation or improper testing.

In no event shall Seller be liable for loss of profits, loss of use, incidental or consequential damages.

Except for any express warranty set forth in a written contract between Seller and Buyer which contract supersedes the terms of this order, this warranty is expressed in lieu of all other warranties expressed or implied, including the implied warranties of merchantability and fitness for a particular purpose, and of all other obligations or liabilities on the Seller's part, and it neither assumes nor authorizes any other person to assume for the Seller any other liabilities in connection with the sale of products under this order.

The use of any non-Atari parts may void your warranty, according to the terms of the warranty. The use of any non-Atari parts may also adversely affect the safety of your game and cause injury to yourself and others. Be very cautious in using non-Atari-supplied components with our games, in order to insure your safety.

Atari distributors are independent, being privately owned and operated. In their judgment they may sell parts or accessories other than Atari parts or accessories. Atari cannot be responsible for the quality, suitability or safety of any non-Atari part or any modification including labor which is performed by such distributor.

This document is and contains confidential trade secret information of Atari, Inc.

This document is loaned under confidential custody for the sole purpose of operation, maintenance or repair of Atari equipment and may not be used by or disclosed to any person for any other purpose whatever, and remains the property of Atari, Inc.

Neither it nor the information it contains may be reproduced, used, or disclosed to persons not having a need to know consistent with the purpose of the loan, without written consent of Atari, Inc.

Matsushita 19-Inch Color Raster Display Service Manual

Complete with Schematic and Illustrated Parts Lists

Display manufactured by Matsushita Electric Industrial Co., Ltd.
Television Products Department
Osaka, Japan



 A Warner Communications Company

© 1982 by Atari, Inc.

All rights reserved.

No part of this publication may be reproduced by any mechanical, photographic, or electronic process, or in the form of a phonographic recording, nor may it be stored in a retrieval system, transmitted, or otherwise copied for public or private use, without permission from the publisher.

This video display manual and its accompanying schematic diagrams are protected by the new Copyright Act of 1976.

This Act provides for increased penalties for violating federal copyright laws. Courts **can impound** infringing articles while legal action is pending. If infringers are convicted, courts can **order destruction** of the infringing articles.

In addition, the Act provides for payment of statutory damages of up to \$50,000 in certain cases. Infringers may also have to pay costs and attorneys' fees, fines up to \$25,000, and face an imprisonment of up to one year.

Atari will aggressively enforce its copyrights against any infringers. **We will use all legal means** to immediately halt any manufacture, distribution or operation of a copy of video games made by us. Anyone who purchases such copies risks forfeiting such a game.

Published by:
ATARI, INC.
1265 Borregas Avenue
P.O. Box 427
Sunnyvale, California 94086

Lithographed in the U.S.A. **10L**

Notice Regarding Non-ATARI Parts

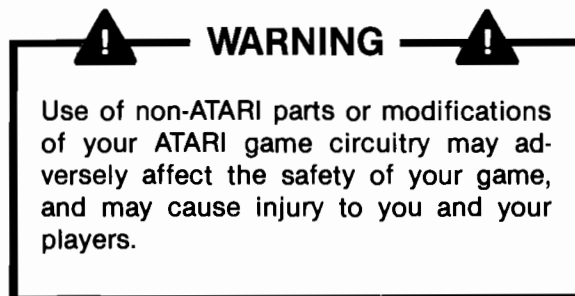

The warranty printed on the inside back cover of this manual may be voided, if you do any of the following:

- you substitute non-ATARI parts in your coin-operated game, or
- you modify or alter any circuits in your ATARI game by using kits or parts **not** supplied by Atari.

Not only may the use of any non-ATARI parts void your warranty, but any such alteration may also adversely affect the safety of your game and may cause injury to you and your players.

Table Of Contents

| | | |
|----------|--|----|
| 1 | Warnings and Cautions | |
| | A. Before You Start | 1 |
| | B. Safety Measures | 2 |
| | C. Cathode-Ray Tube Handling | 2 |
| | D. Replace with Proper Components | 2 |
| | E. Final Testing Before Reinstalling Display | 2 |
| 2 | Specifications | |
| | A. Power Input and Consumption | 3 |
| | B. Temperature and Humidity | 3 |
| | C. Current and Voltages | 3 |
| | D. CRT Specifications | 3 |
| | E. Connectors | 3 |
| | F. Monitor Input Signals | 4 |
| | G. Pattern Size | 4 |
| 3 | Control Adjustments | |
| | A. Brightness | 5 |
| | B. Contrast | 5 |
| | C. Horizontal Hold | 5 |
| | D. Vertical Hold | 5 |
| | E. Horizontal Positioning | 8 |
| | F. Vertical Positioning | 8 |
| | G. Horizontal Size | 8 |
| | H. Vertical Size | 8 |
| | I. Focus | 8 |
| 4 | Signal Test Points | |
| | A. RGB Signals | 11 |
| | B. Sync Signal | 11 |
| 5 | Details of Operation | |
| | A. Sync Separator | 12 |
| | B. Vertical and Horizontal Amplifiers | 12 |
| | C. Horizontal Oscillator Disable Circuit | 17 |
| | D. Z Amplifiers (Red, Green, and Blue) | 17 |
| | E. Blanking | 17 |
| | F. High Voltage | 17 |
| | G. Line Input and Degaussing | 17 |
| | H. + 123-Volt Regulated Supply | 17 |
| 6 | Repair | |
| | A. Cathode-Ray Tube Replacement | 26 |
| | B. Yoke Replacement | 26 |
| | C. Flyback Transformer Replacement | 26 |
| | D. Video Amplifier PCB Replacement | 27 |
| | E. Deflection PCB Replacement | 27 |
| | F. CRT PCB Replacement | 27 |
| | G. Main PCB Replacement | 27 |
| | H. Degaussing PCB Replacement | 28 |

| | | |
|----------|---|----|
| 7 | Adjustments and Testing | |
| | A. Video B + Adjustment | 29 |
| | B. Purity Adjustments | 29 |
| | C. Convergence Adjustments | 31 |
| | D. Tracking Adjustments | 33 |
| | E. Horizontal Oscillator Disable Test | 33 |
| 8 | Illustrated Parts Lists | |
| | Illustrations and Parts Lists Begin on Page | 35 |

List of Illustrations

| | | |
|-----------|---|----|
| Figure 1 | Overview of Matsushita 19-Inch Color Raster Display | 1 |
| Figure 2 | RGB Video Input Signals | 4 |
| Figure 3 | Display Pattern Sizes | 4 |
| Figure 4 | Adjustable Controls and Test Points on Video Amplifier PCB ... | 6 |
| Figure 5 | Adjustable Controls and Test Points on Main PCB | 7 |
| Figure 6 | Adjustable Controls on Deflection PCB | 9 |
| Figure 7 | Block Diagram of the Matsushita 19-Inch Color Raster Display .. | 13 |
| Figure 8 | Sync Separator Schematic Diagram | 14 |
| Figure 9 | Vertical Amplifier Schematic Diagram | 15 |
| Figure 10 | Horizontal Amplifier Schematic Diagram | 16 |
| Figure 11 | Horizontal Oscillator Disable Circuit Schematic Diagram | 18 |
| Figure 12 | Blue Z Amplifier Schematic Diagram | 19 |
| Figure 13 | Blanking Schematic Diagram | 20 |
| Figure 14 | High Voltage Schematic Diagram | 21 |
| Figure 15 | Line Input and Degaussing Schematic Diagram | 22 |
| Figure 16 | + 123-Volt Regulated Supply Schematic Diagram | 23 |
| | Matsushita Schematic | 24 |
| Figure 17 | Locations of Video B + Adjustment R812 and Test Point D91 ... | 30 |
| Figure 18 | Purity and Convergence Adjustments | 31 |
| Figure 19 | Locations of Tracking Adjustments on the CRT PCB | 32 |
| Figure 20 | Location of R802 for Horizontal Oscillator Disable Test | 34 |
| Figure 21 | Display Assembly | 36 |
| Figure 22 | Deflection PCB | 38 |
| Figure 23 | Main PCB | 40 |
| Figure 24 | Neck PCB | 46 |
| Figure 25 | Video Amplifier PCB | 48 |
| Figure 26 | Degaussing PCB | 50 |

1 Warnings and Cautions

A. Before You Start

This color raster display has been built to Atari specifications by Matsushita Electric Industrial Co., Ltd. This display is contained within a separate chassis inside the game cabinet. The Main printed-circuit board (PCB) is mounted to the display chassis under the cathode-ray tube (CRT). The Video Amplifier PCB and Deflection PCB are mounted to the rear of the display chassis with the Video Amplifier PCB located above the Deflection PCB. The CRT PCB is attached to the neck pins of the CRT. The Degaussing PCB is mounted to the left side of the CRT neck, just behind the Video Amplifier PCB and Deflection PCB. Input signals for the display are supplied through a 6-pin connector on the Video Amplifier PCB.

Never attempt to work on a display until you are familiar with servicing precautions and procedures necessary for high-voltage equipment. Remember, any video display has at least three sources of possible danger:

- Strong electric shock, due to high voltage or AC line voltage
- X-ray radiation (if the display is out of adjustment)
- Implosion

Therefore, never modify any circuit in this display.

Perform servicing on a video display only after you are thoroughly familiar with all warnings and safety measures given in this chapter.

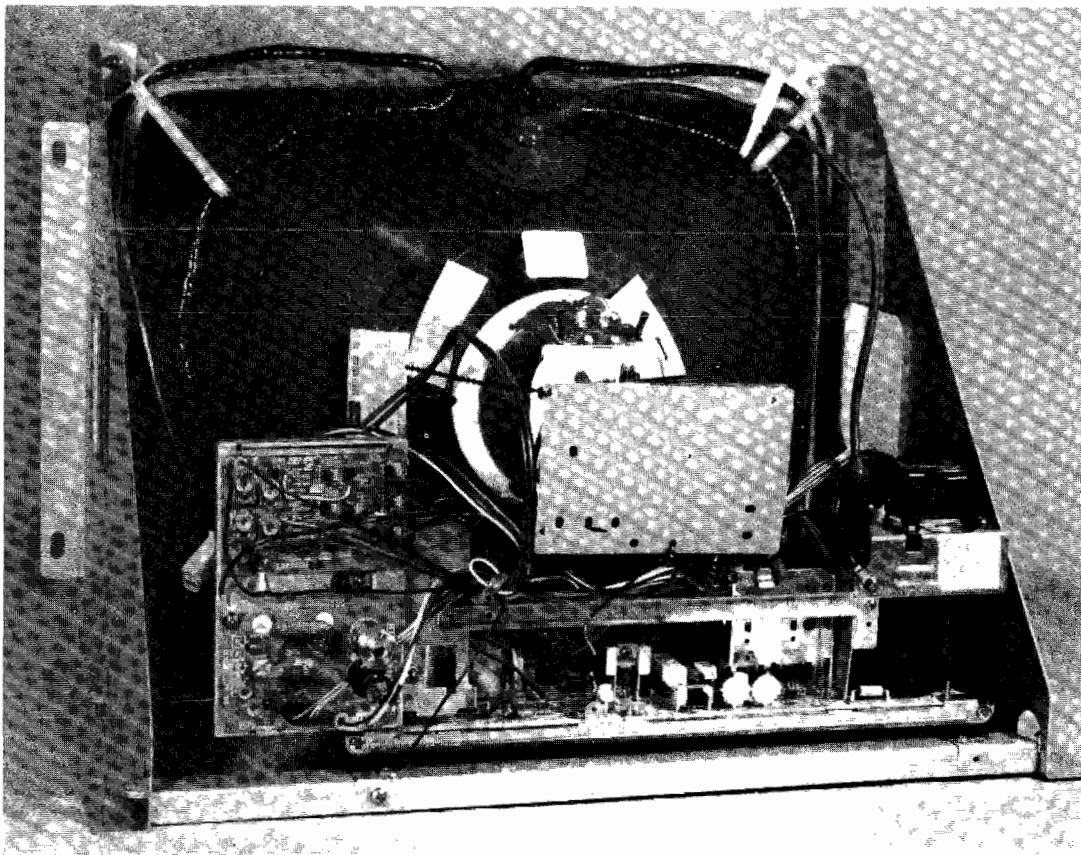

Figure 1 Overview of Matsushita 19-Inch Color Raster Display

WARNINGS

High-Voltage

This display contains high voltages capable of delivering lethal quantities of energy. To avoid danger, do not attempt to service the chassis until you have observed all precautions necessary for working on high-voltage equipment.

X-Radiation

This chassis has been designed for minimum X-radiation hazard. However, to avoid possible exposure to soft X-radiation, it is imperative that you never modify the high-voltage circuitry.

Implosion Hazard

If you drop the display and the cathode-ray tube breaks, it will implode! Shattered glass and the yoke assembly can fly 6 feet or more from the implosion. Use care when replacing any display.

B. Safety Measures

Good safety habits will allow you to automatically take the proper precautions, even if you are rushed. Whenever you work on a display, always ground the chassis first. Also, use only one hand. This avoids the possibility of carelessly putting one hand on the chassis or ground and the other on an electrical connection. Doing so could cause a severe electrical shock.

If you service the Matsushita 19-Inch Color Raster Display on a test bench, use an isolation transformer or the power supply that came with the game. (Refer to the parts lists within the game manual for the Atari part number of the Power Supply Assembly for Color Raster Games.) Do not use line voltage or a power supply from a black-and-white game, because the voltages produced by those sources will damage this display.

To prevent fire or shock hazard, never expose this display to moisture.

Periodically check for frayed insulation on the wires within the display. If frayed wires are found, replace them with the same gauge, insulation type, thickness and length of wire. Always observe the original lead dress (routing and length of harness wires).

Use extra precaution in the high-voltage circuitry areas of the display. If a short circuit occurs, replace any components that indicate they may have overheated.

C. Cathode-Ray Tube Handling

Wear safety goggles and heavy gloves for protection whenever you handle a cathode-ray tube (CRT). Keep other people away if they are not wearing safety goggles. Never lift the CRT only by the neck; the neck should only be used to guide the lifting process.

Use extreme care when handling the CRT! Rough handling may cause it to implode. Do not nick or scratch the glass or subject any undue pressure upon the tube at any time.

If servicing the CRT, discharge the high voltage on the anode connection to chassis ground—not to the cabinet or other mounting parts. When discharging the anode, go from ground to the anode connection with a well-insulated 20-kV jumper. Allow two minutes to pass and discharge the anode again.

D. Replace with Proper Components

Maintain the specified values of all components within the display. Failure to do so could cause a rise in the high voltage.

The cathode-ray tube of this display employs integral implosion protection. For continued safety, replace it only with a tube of the same type number. Refer to the parts lists in Chapter 8 of this manual. For continued product safety, use only exact replacement parts, especially for those parts identified in the parts lists with the ▲ symbol and on the schematic diagrams with shading.

E. Final Testing Before Reinstalling Display

Before reinstalling this color display into the game, you must check the following:

1. Inspect all harness wiring within the display area. Be sure no wires or cables are pinched between the cabinet and other parts in the display.
2. Replace all protective devices such as insulating fishpaper, compartment covers, and shields.
3. Perform the *Horizontal Oscillator Disable Circuit Test* given in Chapter 7.

2 Specifications

A. Power Input and Consumption

| | |
|-------------------|---|
| Line Voltage | 120 VAC, within +10% and -15%; or 145 VDC, within $\pm 5\%$ (Atari, Inc. will specify the type of input voltage at the time of purchase.) |
| Line Frequency | 47 to 63 Hz |
| Power Consumption | 150 W maximum |

B. Temperature and Humidity

| | |
|-------------------------|------------------------------|
| Ambient Air Temperature | 0° to +55°C (+32° to +151°F) |
| Environmental Humidity | 10–90%, noncondensing |

C. Current and Voltages

| | |
|-----------------------------|---|
| CRT Anode Current (Average) | $<700 \mu\text{A}$ |
| High Voltage | +26.5 kV ± 1.5 kV |
| B + 1 | +180 V, within ± 1.0 V |
| B + 2 | +123 V, within ± 0.5 V (adjustable) |
| B + 3 | +20 V, within ± 2.0 V |
| B + 4 | +12 V, within ± 1.0 V |
| CRT Heater Voltage | ± 6.4 V, within ± 0.2 VAC (RMS) |

D. CRT Specifications

Convergence Tolerance:

| | |
|------------------|---|
| At Screen Center | 0.25 mm (0.4 mm total) maximum misconvergence |
| At Screen Edges | 0.5 mm (0.7 mm total) maximum misconvergence |

Color Purity:

Practically uniform throughout the screen area after degaussing with a hand-held degaussing coil.

Scan Rates:

| | |
|------------|---------------------------------|
| Horizontal | 15.750 kHz, within ± 400 Hz |
| Vertical | 60 Hz, within ± 5 Hz |

CRT Type:

#510TFB22AW, 19-inch, 90°

Tilt of Deflection Yoke:

Declination of a horizontal line is within 0.10 inch (2.54 mm) of CRT center markers.

E. Connectors

6-Pin Connector for Video Signals:

| | |
|-------|---------------------------|
| Pin 1 | Not Used |
| Pin 2 | Sync (negative composite) |
| Pin 3 | Ground |
| Pin 4 | Blue |
| Pin 5 | Green |
| Pin 6 | Red |

2-Pin Connector for Power:

| | |
|-------|---------|
| Pin 1 | 120 VAC |
| Pin 2 | 120 VAC |

F. Monitor Input Signals

RGB Video Input Signals

The red, green, and blue input signals are at test points N1, N2, and N3 of the Video Amplifier PCB. Waveshape and polarity are as shown in Figure 2.

Sync Signal

The composite synchronization (Sync) signal of horizontal and vertical pulses is at test point D33 of the Main PCB. Sync amplitude is 1-5 volts peak-to-peak with a negative polarity. Pulse width is 3-5 μs horizontally and over 190.5 μs vertically.

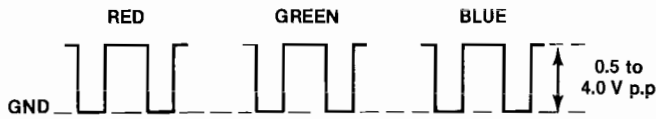

Figure 2 RGB Video Input Signals

G. Pattern Size

You should be able to reproduce the patterns as shown in Figure 3.

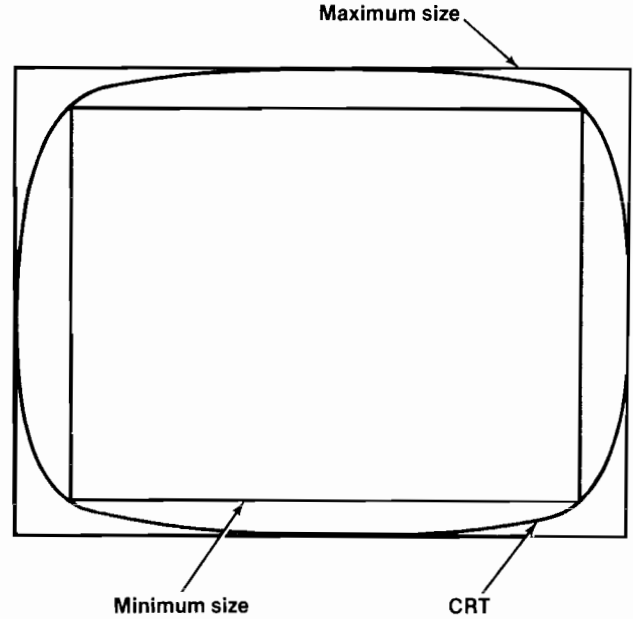

Figure 3 Display Pattern Sizes

3 Control Adjustments

⚠ WARNING ⚠

Remember to observe the precautions regarding high voltages when making adjustments to this display!

NOTE

Before making any of the following adjustments, turn on the display and allow it to warm up for at least 5 minutes.

A. Brightness

BRIGHT control, R344, should be adjusted if the picture image is either too bright or too dark. Figure 4 shows the location of the BRIGHT control on the Video Amplifier printed-circuit board (PCB).

1. Place the game in the attract or play mode.
2. Using the BRIGHT control shown in Figure 4, adjust the display for a pleasing level of brightness.

NOTE

Too high a brightness level will cause the retrace lines to show; too low a level will cause the entire screen to be dark and obscure.

Do not use the SCREEN control to adjust the display brightness.

B. Contrast

R-CONTRAST R341, G-CONTRAST R342, or B-CONTRAST R343 are not operator-adjustable controls. These controls are set at the factory.

C. Horizontal Hold

The H-HOLD control should be adjusted if the picture is drifting sideways across the screen. Figure 5 shows the location of H-HOLD control R505 on the Main PCB. Adjust this control until the black lines no longer slant sideways and a normal screen image is obtained.

D. Vertical Hold

The V-HOLD control should be adjusted if the picture drifts straight up or down on the screen. Figure 5 shows the location of V-HOLD control R402 on the Main PCB. Turn this control until the picture no longer drifts up or down on the screen.

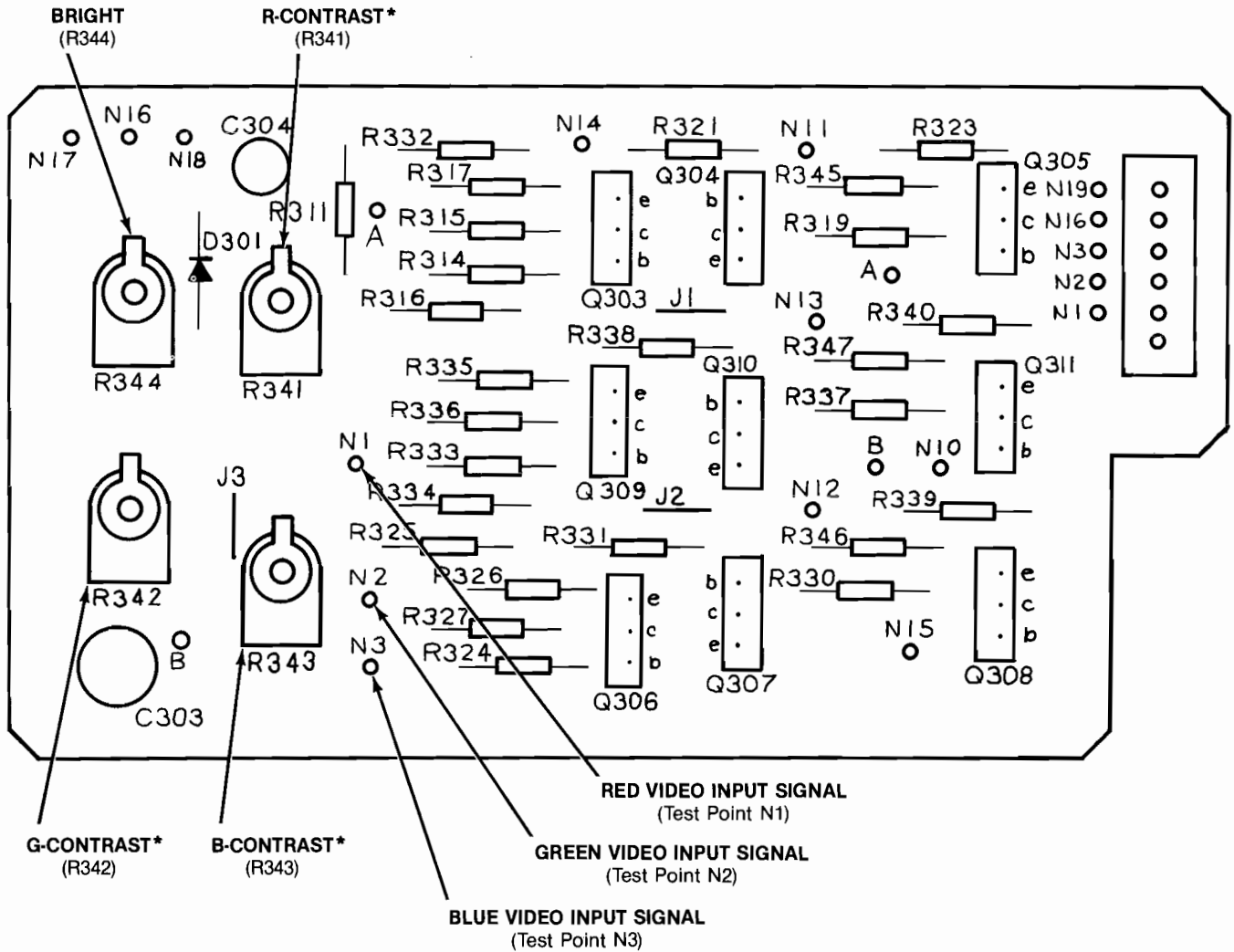

*NOTE: The contrast controls are not operator adjustable.

Figure 4 Adjustable Controls and Test Points on Video Amplifier PCB

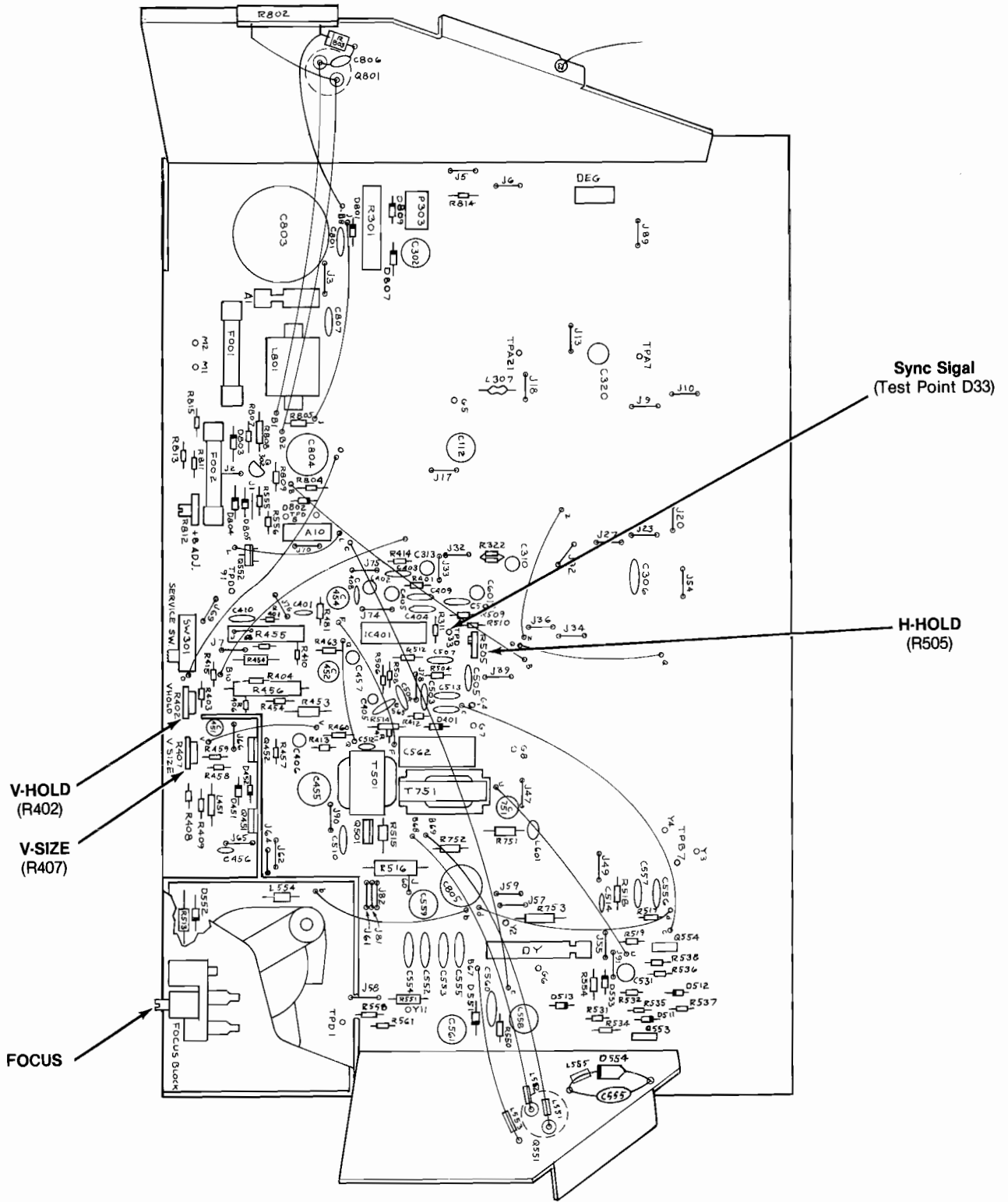

Figure 5 Adjustable Controls and Test Points on Main PCB

E. Horizontal Positioning

The H-POSITION control should be adjusted if the video picture is not centered across the screen, as indicated by a black area at either the left or the right edge of the screen. Figure 6 shows the location of H-POSITION control R523 on the Deflection PCB. Adjust this control until a normal screen image is obtained.

F. Vertical Positioning

V-POSITION jumper D3 should be reset if the video picture is not vertically centered on the screen. Figure 6 shows the location of the V-POSITION jumper on the Deflection PCB. If the picture is too high on the screen, set D3 to pins 1 and 2. If the picture is too low, set D3 to pins 4 and 5.

G. Horizontal Size

The H-SIZE coil should be adjusted if the screen raster is either too wide or narrow. Figure 6 shows the location of H-SIZE control L557 on the Deflection PCB. Adjust the H-SIZE control as follows:

1. Set the game for the self-test diagnostic pattern that displays the convergence grid and dots. (Refer to the game manual for detailed procedures on selecting the self-test patterns.)

2. Use only a non-metallic Allen wrench (commonly called a "tweaking tool") to adjust the H-SIZE coil until the right and left grid lines run along the edges of the screen. These grid lines should not be positioned off the screen, which would indicate over-scanning.

H. Vertical Size

The V-SIZE control should be adjusted if the screen image is either not filling the screen vertically, or if it is overscanning the screen vertically. Figure 5 shows the location of V-SIZE control R407 on the Main PCB. Adjust the V-SIZE control as follows:

1. Set the game for the self-test diagnostic pattern that displays the convergence grid and dots. (Refer to the game manual for detailed procedures on selecting the self-test patterns.)
2. Adjust V-SIZE control R407 until the top and bottom grid lines are along the top and bottom edges of the screen. These grid lines should not disappear off the edges of the screen, which would indicate over-scanning.

I. Focus

The FOCUS control should be adjusted if the CRT screen image is not sharply defined. The FOCUS control is attached to the top of the flyback transformer, as shown in Figure 5. Turn this control until you get optimum screen sharpness.

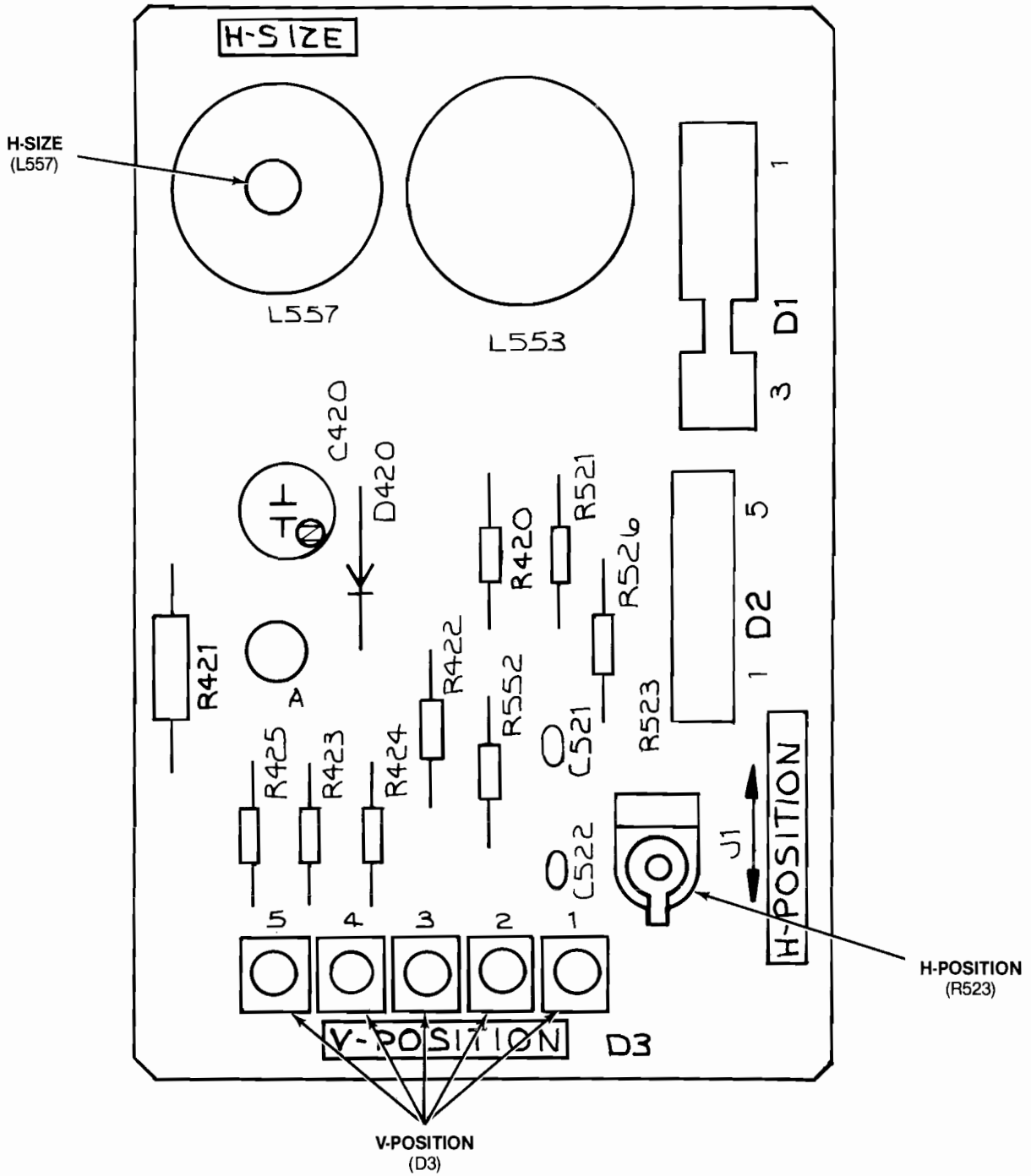

Figure 6 Adjustable Controls on Deflection PCB

4 Signal Test Points

A. RGB Signals

The red, green, and blue signals can be checked at points N1 (red), N2 (green), and N3 (blue). These test points are located on the Video Amplifier printed-circuit board (PCB) as shown in Figure 4 of this manual. The red, green, and blue input signals are illustrated in Figure 2.

B. Sync Signal

The negative composite synchronization (Sync) signal can be checked at test point D33 of the Main PCB as shown in Figure 5. The amplitude is 1 to 5 V peak-to-peak. Pulse width for the horizontal sync component is 3 to 5 μs ; pulse width for the vertical sync component is more than 190.5 μs .

5 Details of Operation

A basic block diagram of the circuitry within this display is shown in Figure 7. Refer to Figure 7 and the schematic diagrams given in Figures 8 through 16 throughout the following discussion.

A. Sync Separator

The synchronization (Sync) signal at pin 2 of the 6-pin connector is a negative composite signal from the game circuitry. (Refer to Figure 8 for a schematic diagram of the sync separator circuitry.) This signal contains both the vertical and horizontal synchronization pulses for the display. The Sync signal is applied through C310 and R322 to the two-stage sync separator at pin 17 of IC401.

B. Vertical and Horizontal Amplifiers

The composite Sync signal from the two-stage sync separator exits at pin 18 of IC401. (Refer to Figure 9 for a schematic diagram of the vertical amplifier.) This signal is passed through double integrator R401-C403-C402-R414 to the input of the vertical oscillator (pin 8 of IC401).

V-HOLD control R402 sets the DC operating level for the vertical oscillator. The output signal from the vertical oscillator (pin 5 of IC401) is modified with the vertical size information from V-SIZE R407 and applied to the Vertical Drive Amplifier at pin 4 of IC401. Final amplification for the vertical deflection signal is provided by Q451-Q452. From here the signal is applied to the deflection yoke of the CRT.

The horizontal Sync signal is also developed from the output signal of the second-stage sync separator. (Refer to Figure 10 for a schematic diagram of the horizontal amplifier circuitry.) This signal is applied to the phase detector within IC401. The DC oscillator frequency-control voltage at pin 16 of IC401 is coupled to the horizontal oscillator through R512 at pin 14 of IC401. H-HOLD control R505 sets the DC operating level for the horizontal oscillator. The output signal from the horizontal oscillator is applied through the horizontal output amplifier of IC401 to pin 12 of IC401. This signal is then applied across R503 to the base of horizontal drive transistor Q501, which provides drive to the primary of transformer T501. The horizontal signal is coupled into the secondary of T501 and applied across R515 to the base of Q551. After final amplification by Q551, the horizontal deflection signal is applied to the deflection yoke of the CRT.

NOTE

Shaded parts of figures in this chapter are not part of the circuitry being discussed.

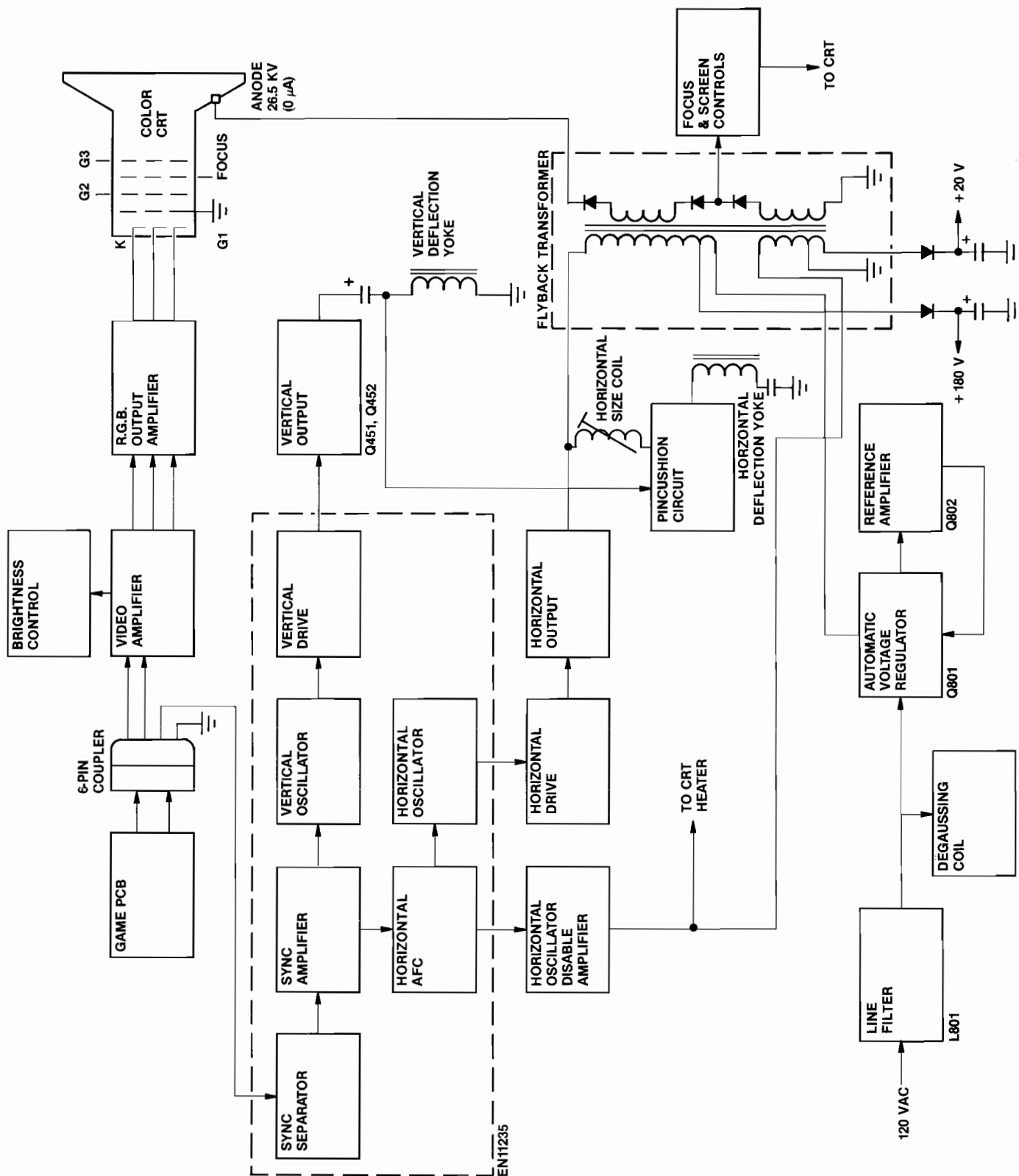

Figure 7 Block Diagram of the Matsushita 19-Inch Color Raster Display

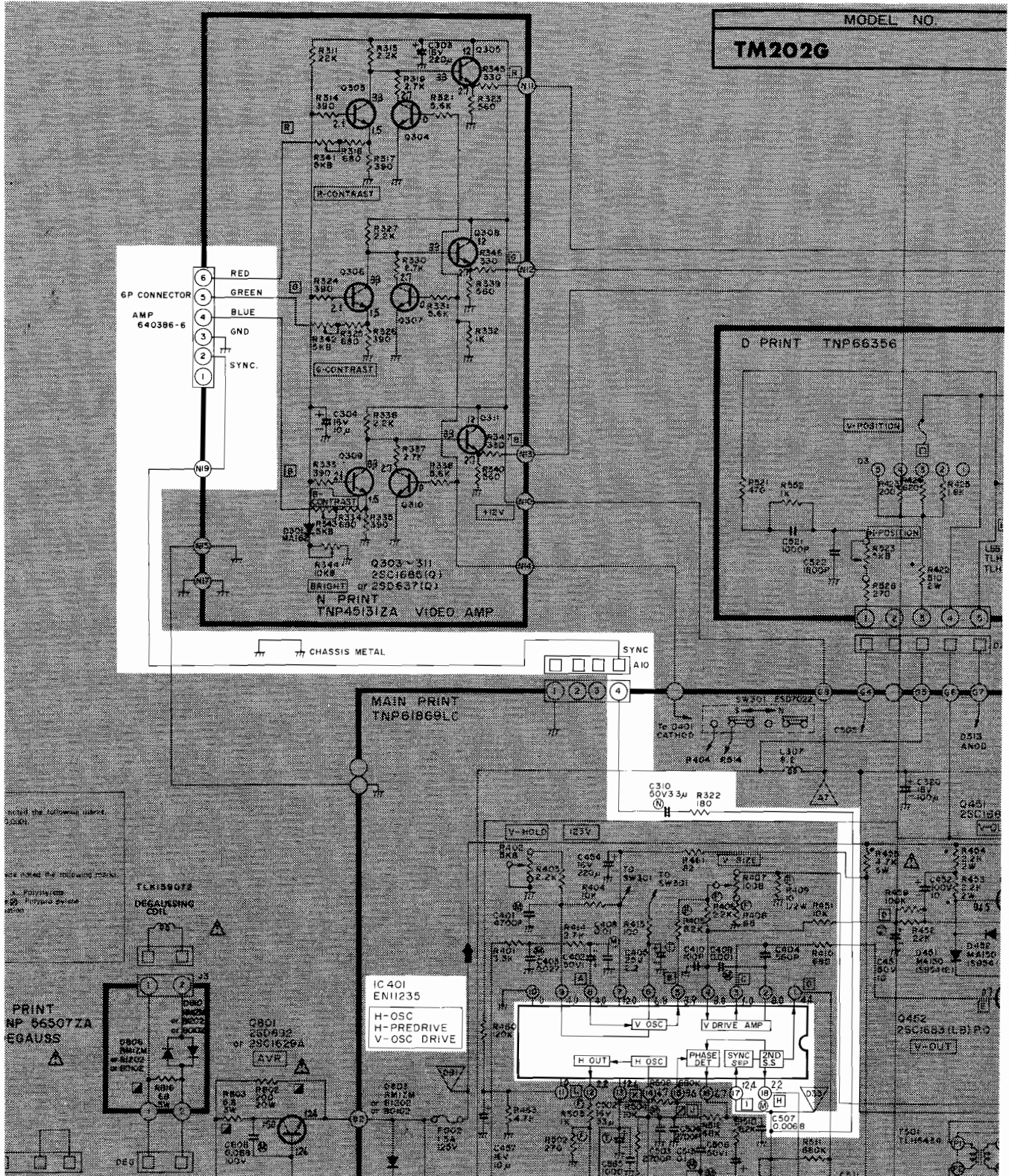

Figure 8 Sync Separator Schematic Diagram

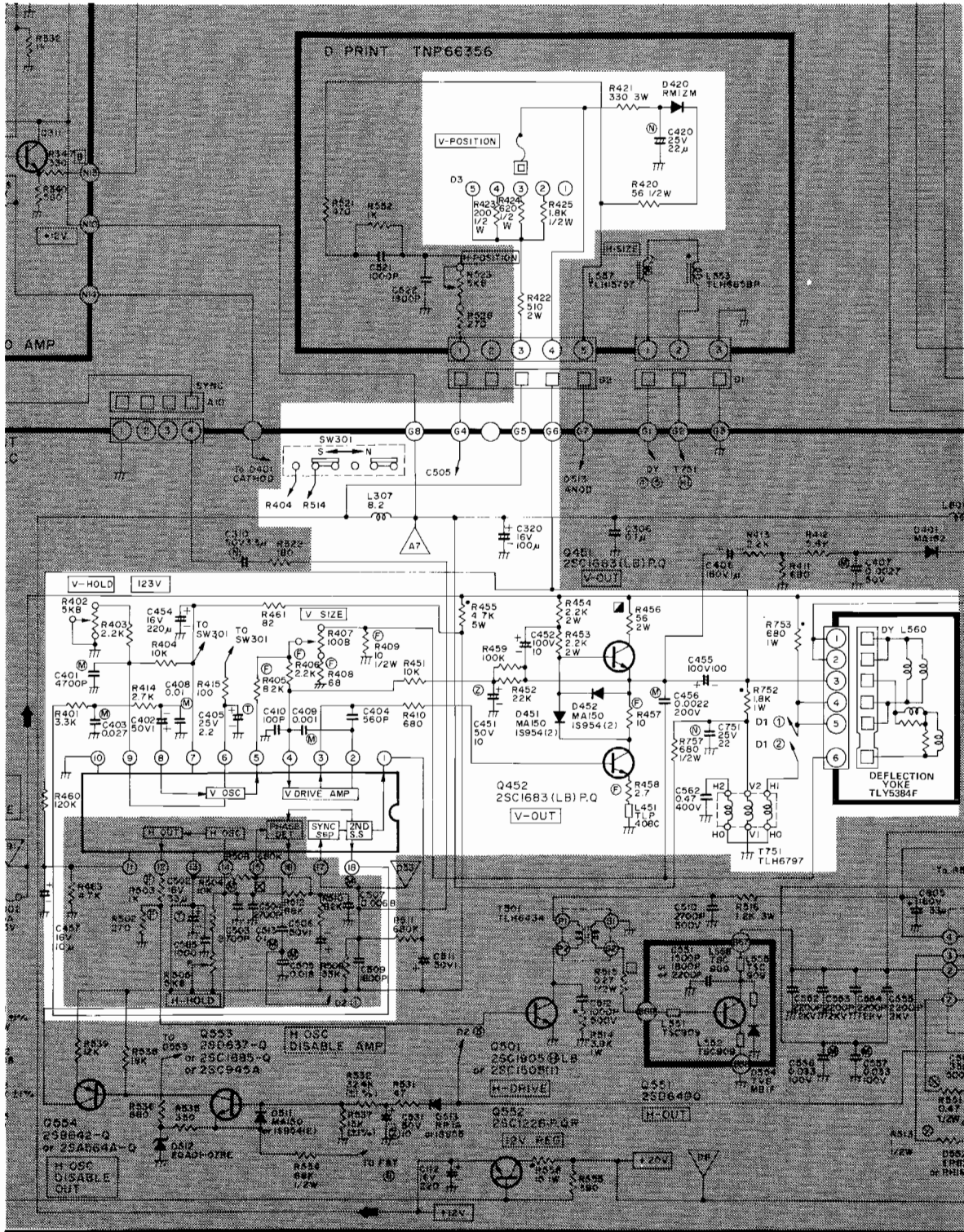

Figure 9 Vertical Amplifier Schematic Diagram

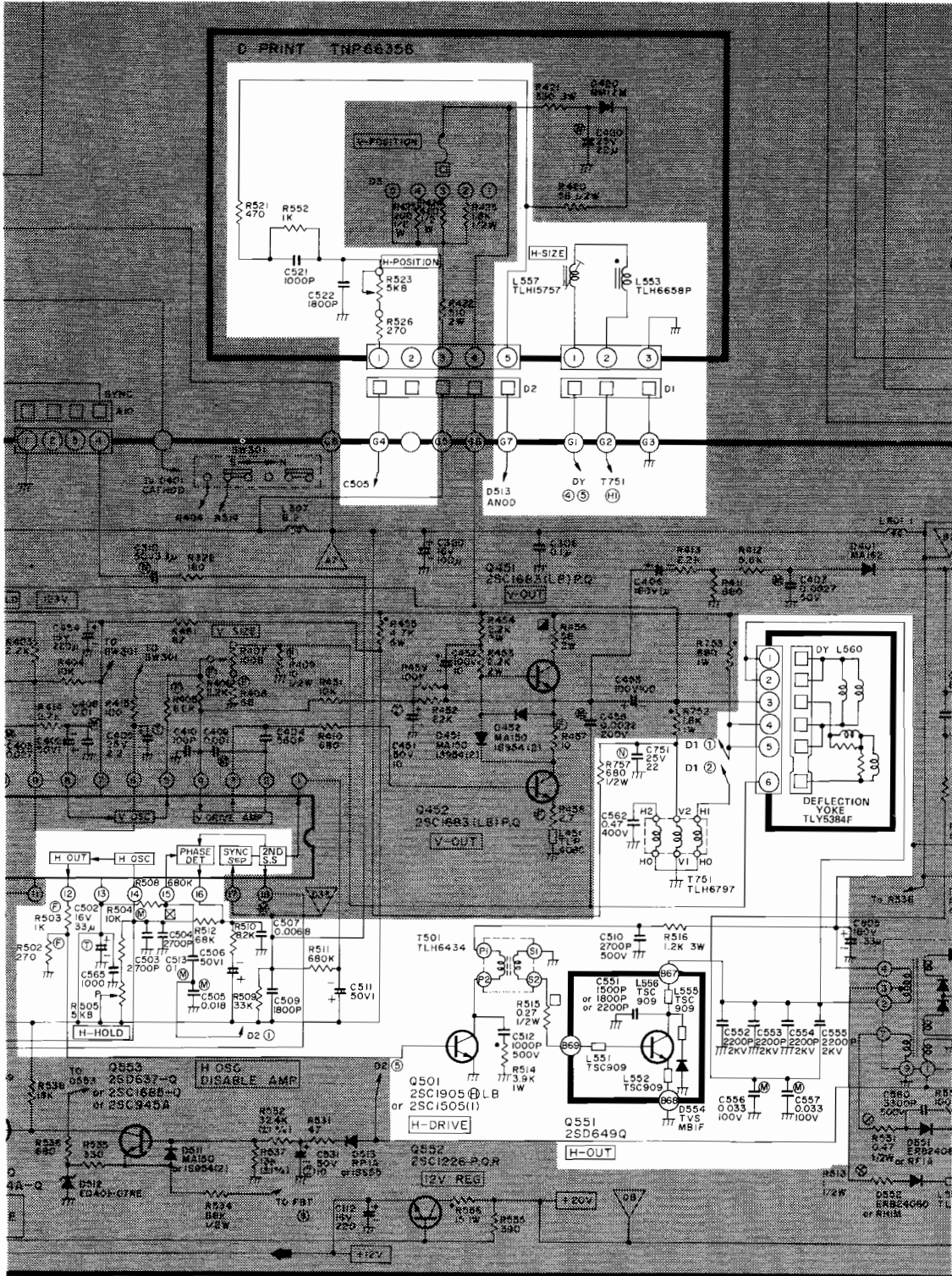

Figure 10 Horizontal Amplifier Schematic Diagram

C. Horizontal Oscillator Disable Circuit

The horizontal oscillator disable circuit turns off the horizontal oscillator within IC401 if the CRT heater voltage rises above +10 volts. (Refer to Figure 11 for a schematic diagram of the horizontal oscillator disable circuitry.) The CRT heater voltage at Y11 of the Main PCB is rectified by diode D513 and applied through R531-R532 to the base of Q553. When the CRT heater voltage rises above +10 volts, Q553 will conduct. This turns on Q554 and kills the horizontal oscillator via pin 14 of IC401.

D. Z Amplifiers (Red, Green, and Blue)

NOTE

Because the Red, Green, and Blue Amplifiers are similar in operation, only the Blue will be discussed here.

The blue intensity signal from the game circuitry is applied from pin 4 of the 6-pin connector to pin N3 of the Video Amplifier PCB. (Refer to Figure 12 for a schematic diagram of the blue Z amplifier.) From here the blue intensity signal is applied across B-CONTRAST control R343 and resistor R334 to common-base transistor Q309. Variable resistor R344, the BRIGHT control, sets the DC operating level for the input transistors of all three Z amplifiers. Transistor Q310 is the blanking transistor for the blue input amplifier. From the collector of Q309, the blue intensity signal is buffered by Q311 and applied across R347 to the base of blue output amplifier Q351 on the CRT PCB. After final amplification by Q351, the signal is applied through R354 to control the blue-cathode gun of the CRT. B-LOW LIGHT adjustment R360 sets the cutoff characteristics of Q351. B-DRIVE adjustment R363 sets the gain of this stage.

E. Blanking

Positive-going vertical and horizontal blanking pulses are derived from the vertical and horizontal deflection signals. (Refer to Figure 13 for a schematic diagram of the blanking circuitry.) The vertical blanking pulse is AC coupled from the vertical output stage through C406. The horizontal blanking pulse is derived from the horizontal output stage through resistors R518 and R517. During retrace, the blanking pulses turn on blanking transistors Q304, Q307, and Q310. The voltage drops at the bases of buffer transistors Q305, Q308, and

Q311 are transferred to the RGB output amplifiers on the CRT board. These voltage drops turn off the RGB output amplifiers.

F. High Voltage

The high voltage is developed by horizontal output transistor Q551 and high-voltage transformer T551. (Refer to Figure 14 for a schematic diagram of the high-voltage circuitry.) When Q551 is turned off, an 800-volt pulse is developed across the primary of T551. This pulse is stepped-up in the secondary and rectified by the internal tripler to produce 26 kilovolts for the anode of the CRT.

Other voltages are also produced by the transformer. These are the Video B+ (180 volts), the low voltage (20 volts), and the CRT filament voltage (6.4 VAC).

G. Line Input and Degaussing

Line voltage of 120 VAC is applied through AC fuse F001 and line-filter L801 to both the degaussing network and the rectifier. When cool, D808 permits current to flow through the degaussing coil. However, after D808 heats up, current is removed from the degaussing coil, rendering it inoperative.

The rectifier is composed of D801. This rectifier converts the AC input voltage into an unfiltered DC voltage. Capacitor C803 filters out AC ripple.

H. +123-Volt Regulated Supply

The +123-volt regulated supply provides operating power to circuitry throughout the display. (Refer to Figure 16 for a schematic diagram of the +123-volt regulated supply.) The regulator for the +123-volt regulated supply is a feedback amplifier system that operates between ground and the rectified DC voltage. Current to the load is delivered by series-pass transistor Q801. The supply voltage is established by the voltage drop across resistive-divider network R811-R812-R813-R815 at the base of Q802.

Feedback at the base of Q802 is immediately coupled to Q801. Any variation in the supply output voltage (due to changing load requirements) causes Q802 to modify the biasing current of Q801. This nullifies the change in the supply output voltage.

DC fuse F002 provides circuit protection in the event of an overload or regulator malfunction.

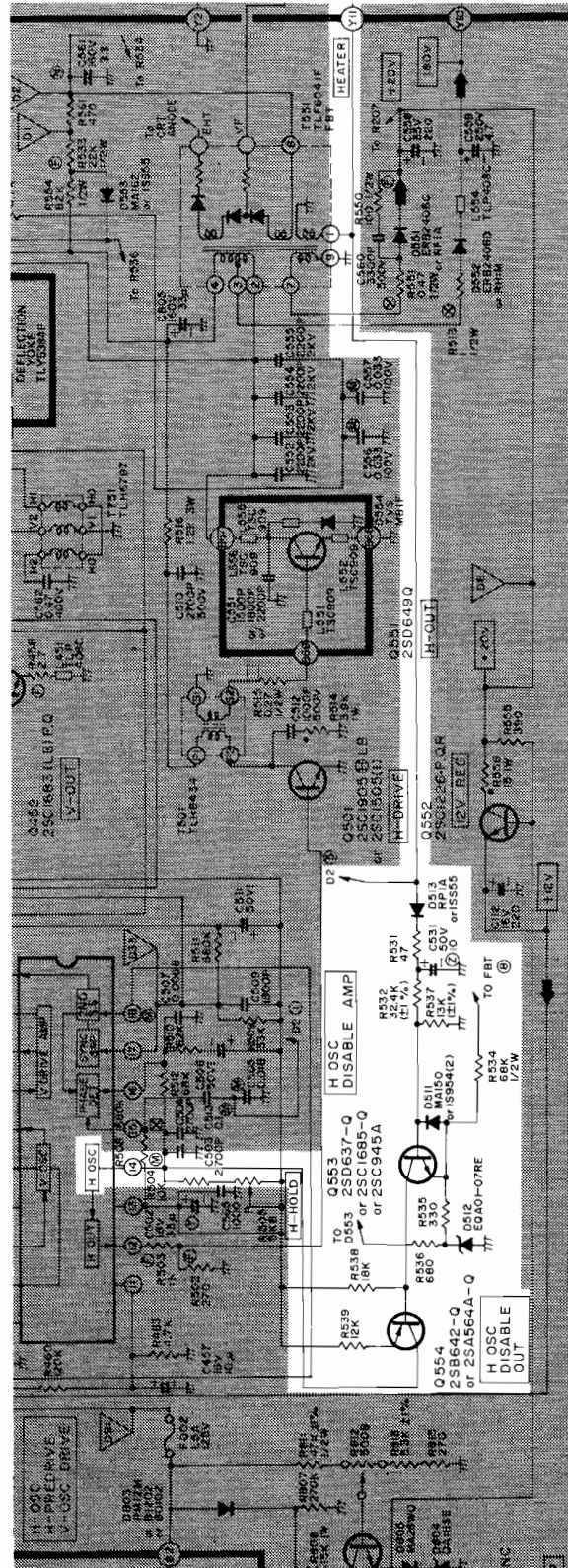

Figure 11 Horizontal Oscillator Disable Circuit Schematic Diagram

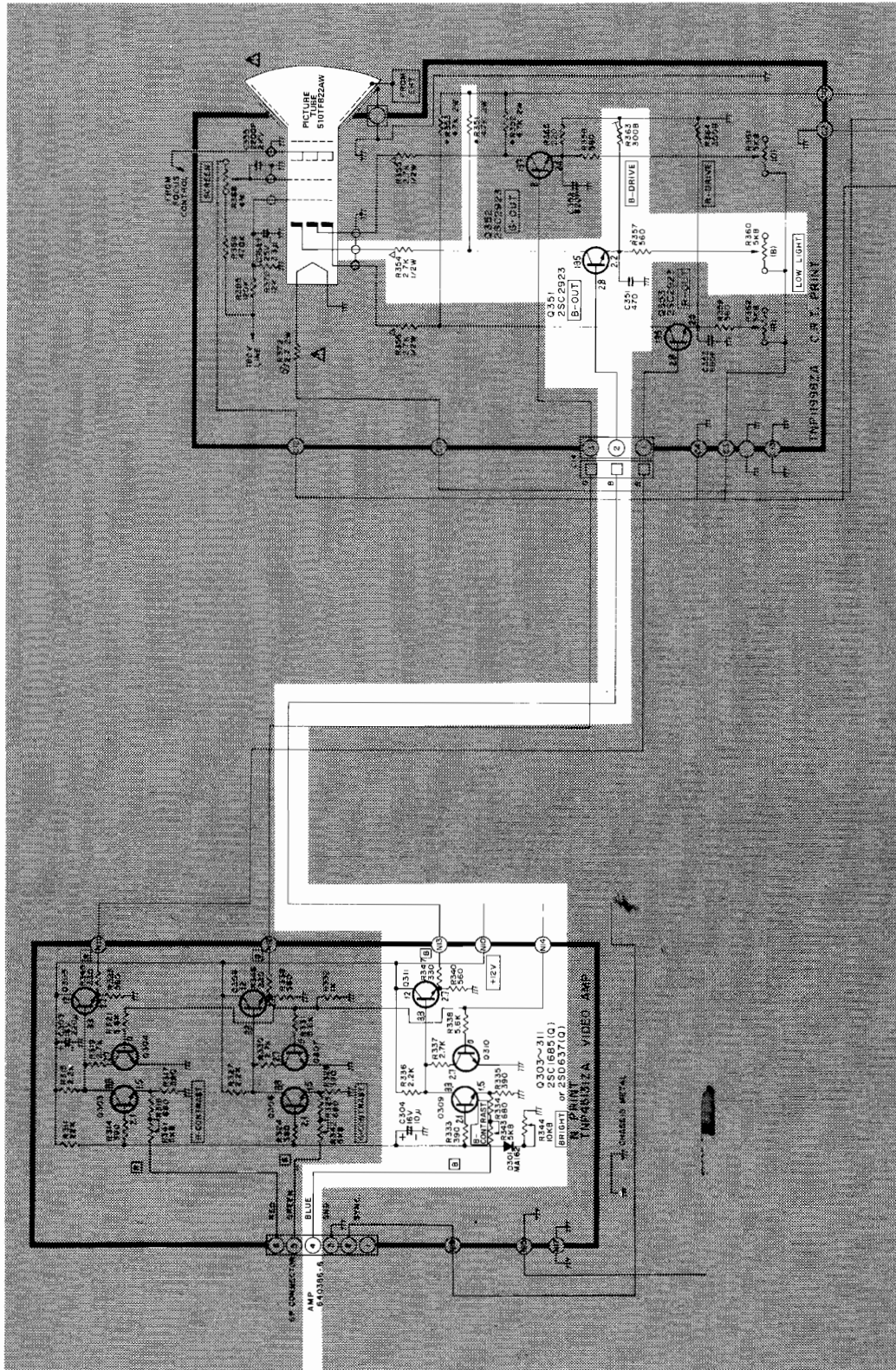

Figure 12 Blue Z Amplifier Schematic Diagram

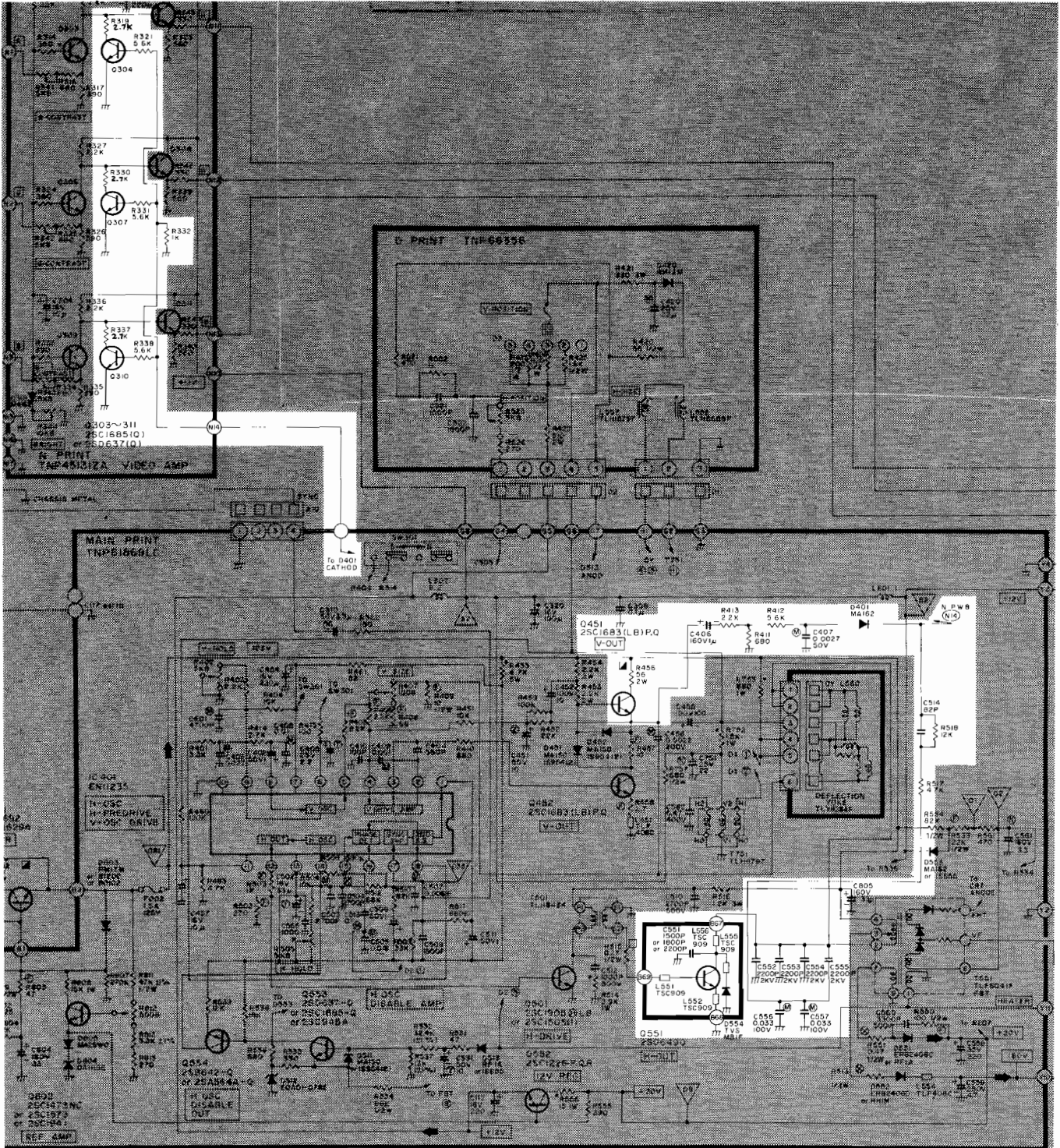

Figure 13 Blanking Schematic Diagram

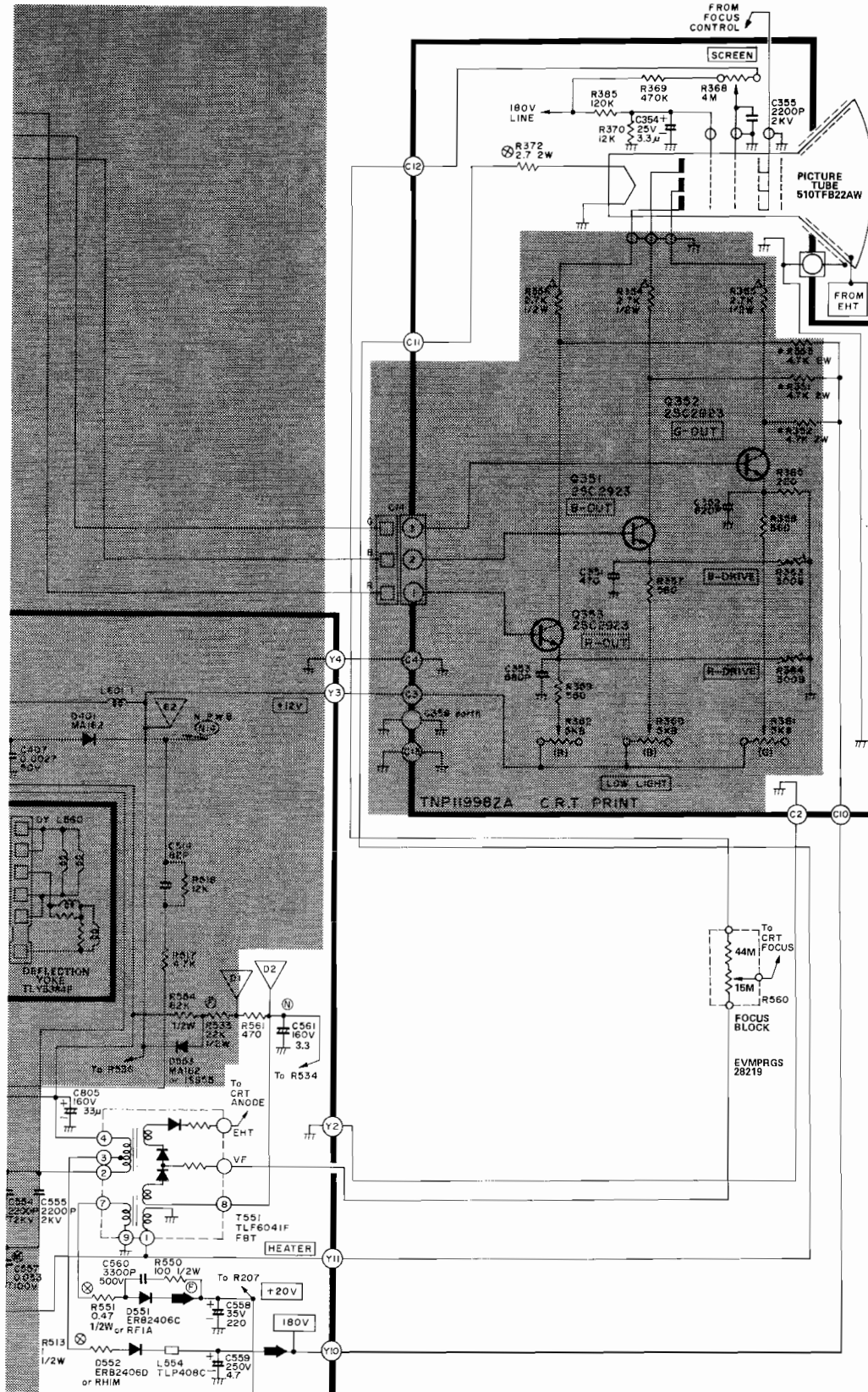

Figure 14 High-Voltage Schematic Diagram

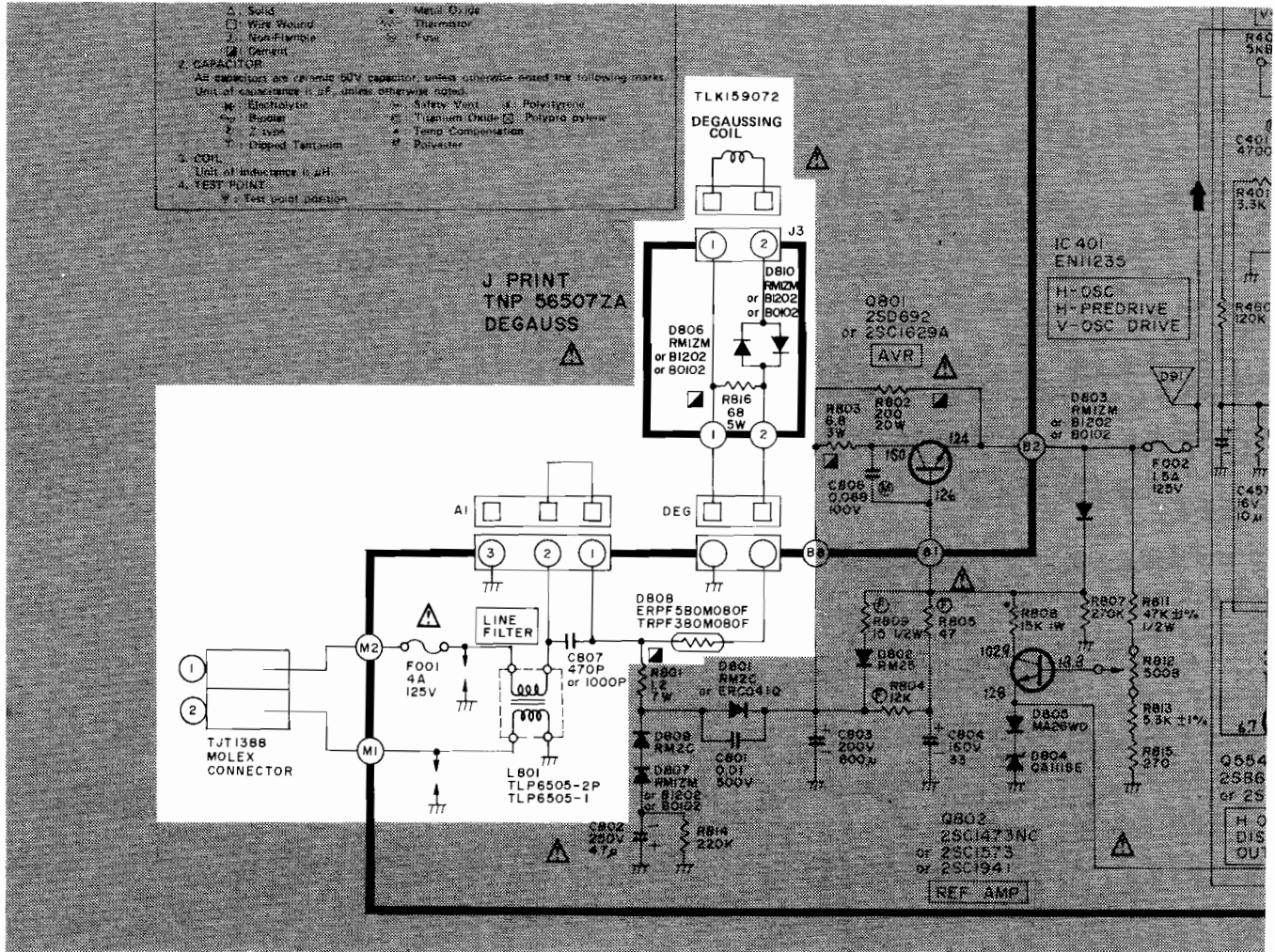

Figure 15 Line Input and Degaussing Schematic Diagram

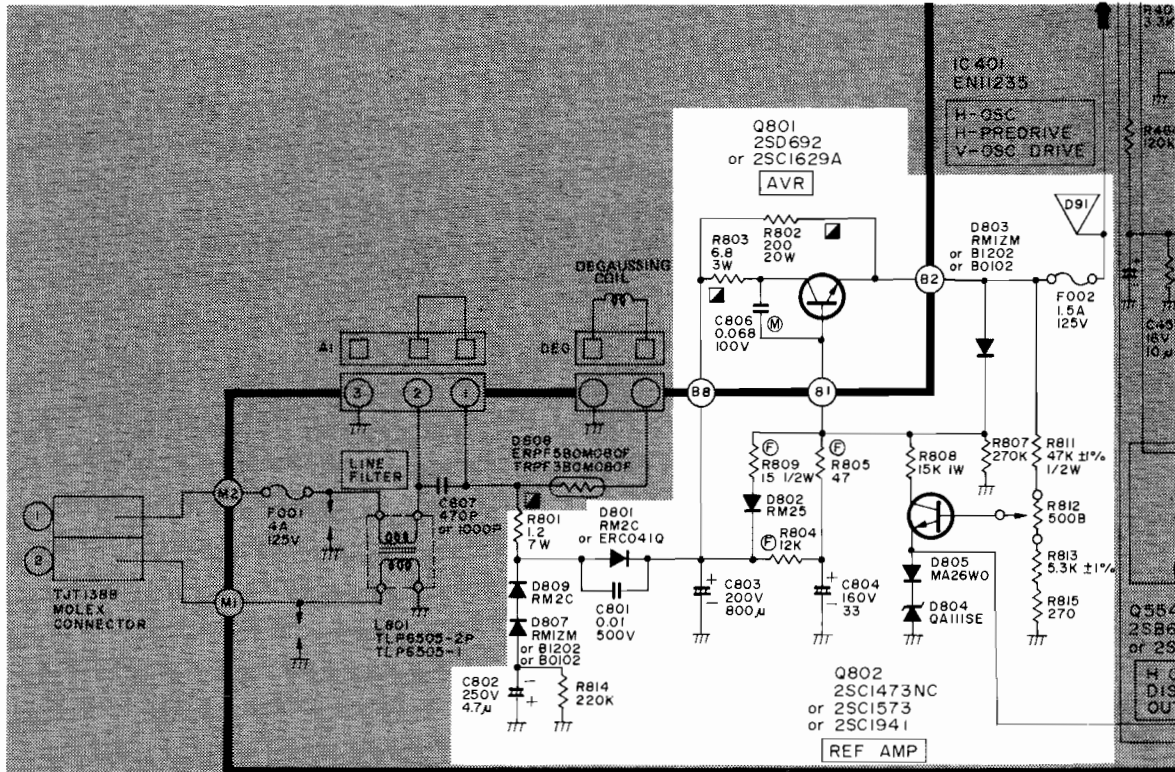
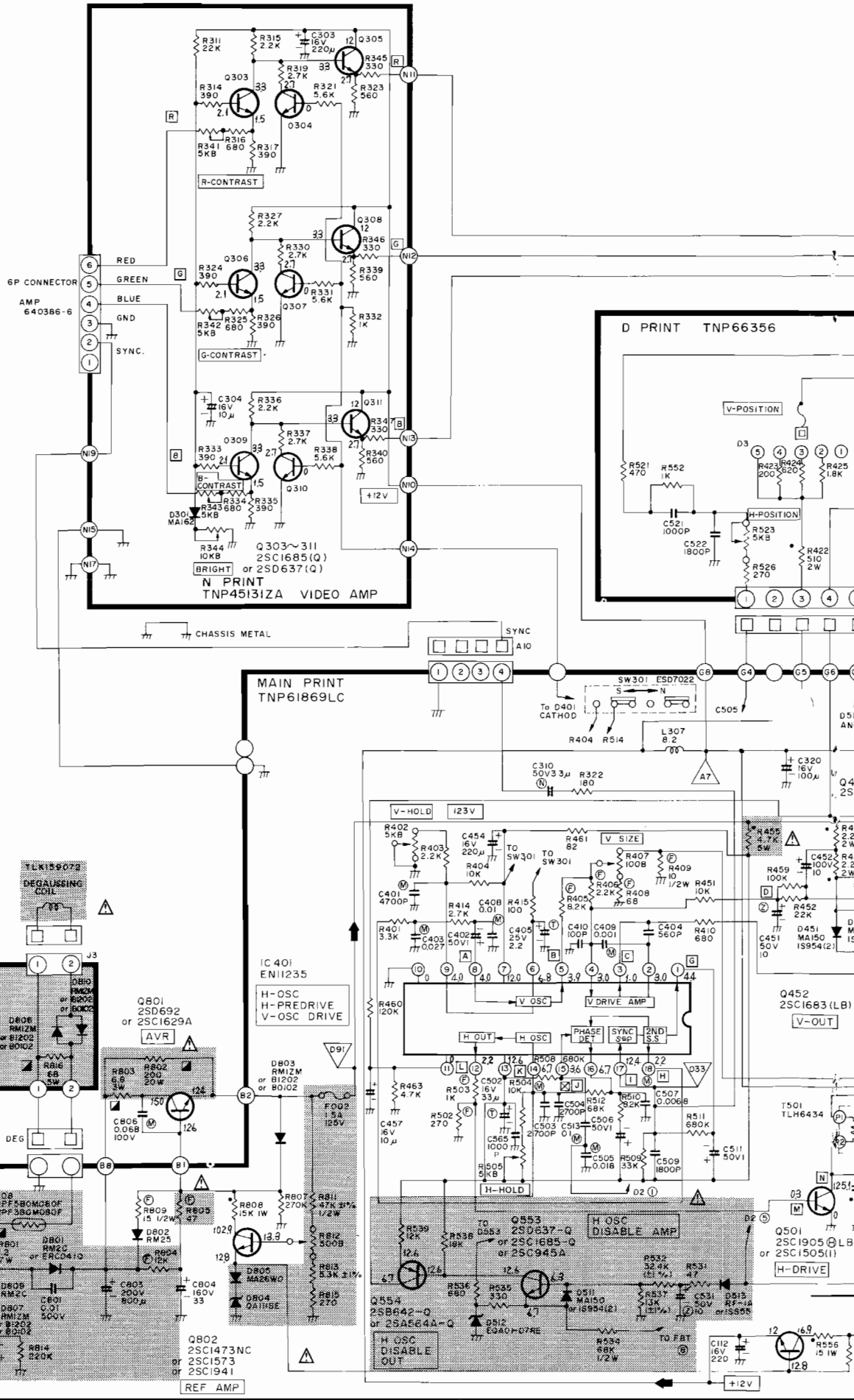

Figure 16 +123-Volt Regulated Supply Schematic Diagram

Matsushita Schematic



WARNING

Components identified by shading have special characteristics important to safety and should be replaced only with identical types.

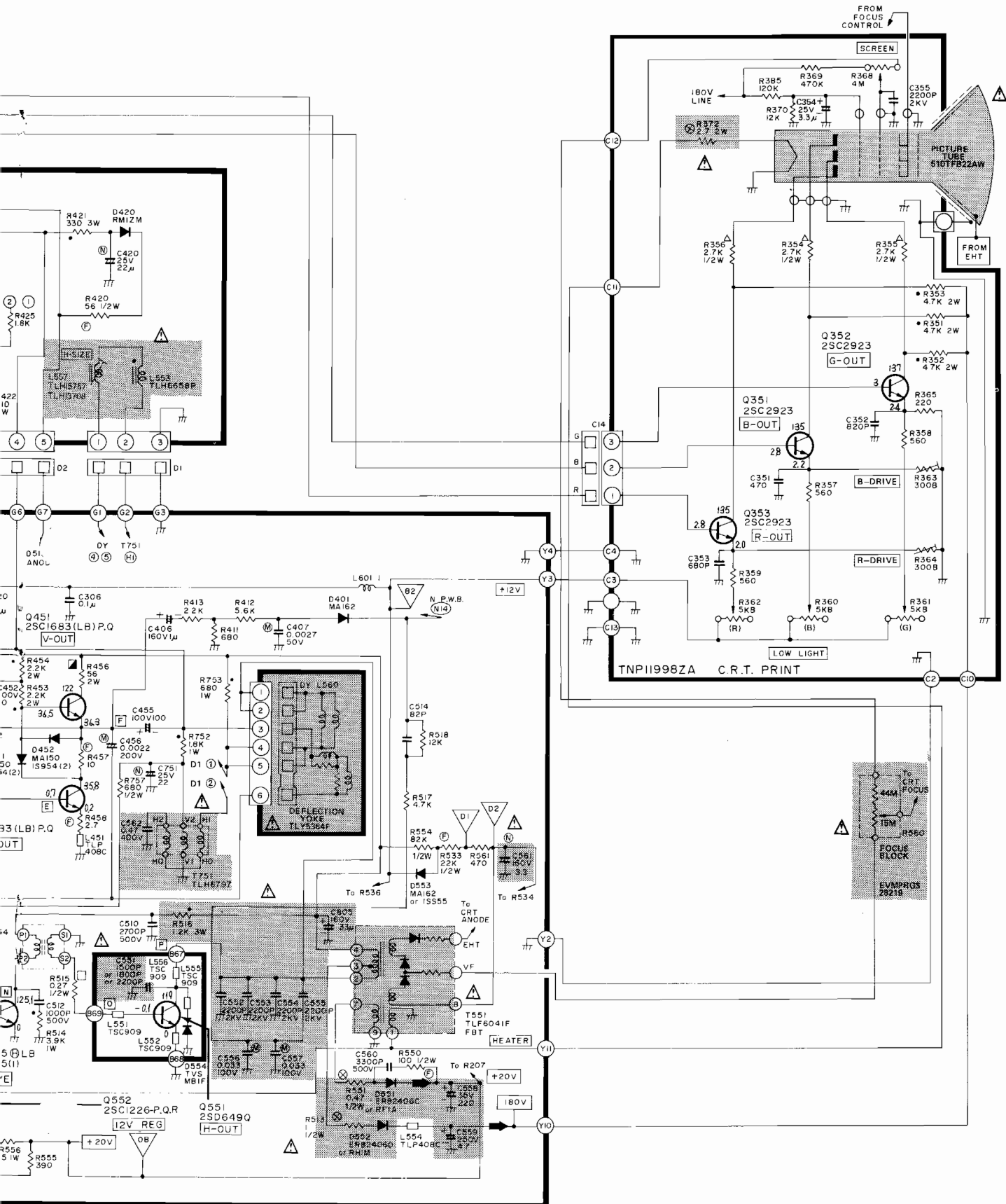

6 Repair



WARNING



Before removing or installing any component of this display, always disconnect the power source! Observe the precautions regarding high voltages and cathode-ray tube handling when servicing this display.

Tools Required to Replace These Assemblies: $\frac{5}{16}$ -inch hex socket wrench, Phillips-head screwdriver, and a soldering iron.

A. Cathode-Ray Tube Replacement

NOTE

You must readjust the Brightness and perform the purity and convergence adjustment procedures whenever the cathode-ray tube is replaced.

1. Disconnect the 6-pin video-signal connector from the Video Amplifier printed-circuit board (PCB).
2. Remove the display assembly from the game as described in the game manual.
3. Discharge the high voltage from the cathode-ray tube (CRT) as follows:
 - a. Attach one end of a large, well-insulated, 20-kV jumper to ground.
 - b. Momentarily touch the free end of the grounded jumper to the anode by sliding it under the anode cap.
 - c. Wait two minutes.
 - d. Discharge the anode again.
 - e. **Carefully** remove the large high-voltage anode connector from the CRT.
4. Unplug the 1-wire connector from pin CRT E of the CRT PCB.
5. Unplug the CRT PCB from the rear of the cathode-ray tube.
6. Unplug the degaussing coil 2-pin connector from the Degaussing PCB.
7. Unplug the 4-wire connector attaching the yoke wires to the Main PCB.
8. Use a $\frac{5}{16}$ -inch hex socket wrench to remove the four screws holding the CRT to the steel frame chassis.
9. **Carefully** remove the CRT by easing it out the front of the chassis.
10. Place the cathode-ray tube on a soft mat in a protected location.
11. To install a CRT, reverse the order of this procedure.

B. Yoke Replacement

NOTE

You must reconverge the picture and readjust the color purity whenever the yoke is replaced.

1. Disconnect the 6-pin video-signal connector from the Video Amplifier printed-circuit board (PCB).
2. Remove the display assembly from the game as described in the game manual.
3. Discharge the high voltage from the CRT using the procedure given in step 3 under A. *Cathode-Ray Tube Replacement*.
4. Unplug the CRT PCB from the neck pins of the CRT.
5. Remove the cloth tapes securing the three rubber wedges beneath the yoke collar.
6. Use a thin knife or a single-edged razor blade to carefully loosen the three rubber wedges from the CRT surface.
7. Use a Phillips-head screwdriver and your fingers to loosen the screws that secure the two neck clamps around the CRT.
8. Slide the magnet assembly and the yoke assembly off the end of the CRT.
9. To replace a yoke assembly, reverse the order of this procedure.

C. Flyback Transformer Replacement

1. Disconnect the 6-pin video-signal connector from the Video Amplifier printed-circuit board (PCB).
2. Remove the display assembly from the cabinet as described in the game manual.
3. Discharge the high voltage from the CRT as described in step 3 under A. *Cathode-Ray Tube Replacement*.
4. Remove the rubber cap from the white wire connected to the focus assembly on the Main PCB. Unsolder this wire from the focus assembly.

5. Remove the tape from the three wires (red, black, and white) that go to the focus assembly.
6. Open the white twist-and-tie wire holder and remove the white wire.
7. Use a Phillips-head screwdriver to remove the screw securing the focus assembly. Remove the focus assembly.
8. Remove the two screws that secure the housing for the flyback transformer.
9. Remove the Main PCB following the procedure beginning at step 4 of *G. Main PCB Replacement*.
10. Remove the three screws securing the transformer to the Main PCB.
11. Unsolder the eight transformer connections on the bottom side of the Main PCB.
12. Lift the transformer from its housing.
13. Replace the transformer by reversing this procedure. Be sure to check the picture for sharpness after the transformer is replaced. If appropriate, readjust the FOCUS.

D. Video Amplifier PCB Replacement

1. Disconnect the 6-pin video-signal connector from the Video Amplifier printed-circuit board (PCB).
2. Remove the display assembly from the cabinet as described in the game manual.
3. Discharge the high voltage from the CRT as described in step 3 under *A. Cathode-Ray Tube Replacement*.
4. Use a Phillips-head screwdriver to remove the screw securing the Video Amplifier PCB to the chassis.
5. Slide the Video Amplifier PCB toward the Deflection PCB and remove it from the display.
6. To replace the Video Amplifier PCB, reverse the order of this procedure.

E. Deflection PCB Replacement

1. Disconnect the 6-pin video-signal connector from the Video Amplifier printed-circuit board (PCB).
2. Remove the display assembly from the cabinet as described in the game manual.
3. Discharge the high voltage from the CRT as described in step 3 under *A. Cathode-Ray Tube Replacement*.

4. Using a Phillips-head screwdriver, remove the two screws securing the Deflection PCB to the chassis.
5. Slide the Deflection PCB toward the Video Amplifier PCB and remove it from the display.
6. To replace the Deflection PCB, reverse the order of this procedure.

F. CRT PCB Replacement

1. Disconnect the 6-pin video-signal connector from the Video Amplifier printed-circuit board (PCB).
2. Remove the display assembly from the cabinet as described in the game manual.
3. Discharge the high voltage from the CRT as described in step 3 under *A. Cathode-Ray Tube Replacement*.
4. Gently pull the CRT PCB from the neck pins of the CRT.
5. To replace the CRT PCB, reverse the order of this procedure.

G. Main PCB Replacement

1. Disconnect the 6-pin video-signal connector from the Video Amplifier printed-circuit board (PCB).
2. Remove the display assembly from the cabinet as described in the game manual.
3. Discharge the high voltage from the CRT as described in step 3 under *A. Cathode-Ray Tube Replacement*.
4. Unplug the CRT PCB from the neck pins of the CRT.
5. Use a Phillips-head screwdriver to remove the screw securing the black ground wire to the chassis frame at the rear of the display.
6. Use a Phillips-head screwdriver to remove the two screws securing the Main PCB to the black plastic spacers at the rear of the display.
7. Gently pull the Main PCB out the rear of the chassis.

NOTE

The Video Amplifier PCB, Deflection PCB, and Degaussing PCB are mounted on a frame that is attached to the Main PCB; therefore, these circuit boards will come with the Main PCB when the Main PCB is removed.

8. To replace the Main PCB, reverse the order of this procedure.

H. Degaussing PCB Replacement

1. Disconnect the 6-pin video-signal connector from the Video Amplifier PCB.
2. Remove the display assembly from the cabinet as described in the game manual.
3. Discharge the high voltage from the CRT as described in step 3 under *A. Cathode-Ray Tube Replacement*.
4. Using a Phillips-head screwdriver, remove the two screws securing the Degaussing PCB to the chassis.
5. To replace the Degaussing PCB, reverse the order of this procedure.

7 Adjustments and Testing

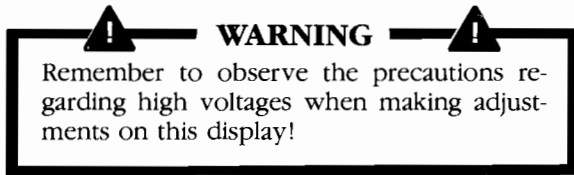

Before adjusting the display, remove the display assembly from the game using the procedure given in the game manual. Leave connected all cables between the display assembly and other parts of the game.

A. Video B + Adjustment

1. Set BRIGHT control R344 on the Video Amplifier PCB for maximum brightness. Refer to Figure 4 for the location of the BRIGHT control.
2. Remove power from the display.
3. Set a DC voltmeter to the 0-volt to +150-volt range.
4. Connect the plus lead of the voltmeter to test point D91, which is shown in Figure 17.
5. Apply power to the display.
6. Adjust R812 on the Main PCB, shown in Figure 17, for a voltmeter reading of +123 volts.
7. Return BRIGHT control R344 to its normal setting.

B. Purity Adjustments

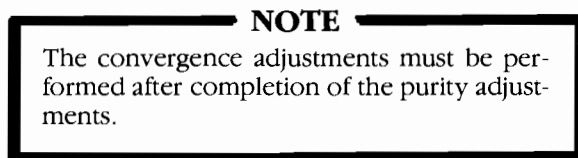

1. Set up the display for the purity adjustments as follows:
 - a. Remove power from the display.
 - b. Loosen the screws that are used to tighten the deflection yoke and convergence-magnet assembly clamps to the neck of the cathode-ray tube (CRT).

- c. Remove any glue that may be holding the purity magnets in place.
 - d. Remove the cloth tapes securing the three rubber wedges beneath the deflection yoke of the CRT. Use a razor blade or thin knife to loosen any glue holding the rubber wedges to the CRT surface. Remove these wedges.
 - e. Position the display so that the CRT faces either north or south. Degauss the CRT with a hand-held degaussing coil.
 - f. Apply power to the display.
2. Position the convergence-magnet assembly so that the purity rings shown in Figure 18 are positioned directly over the gap in the cathode-ray tube gun assembly. This is about two inches forward from the start of the neck glass.
3. Secure the convergence-magnet assembly in position by tightening the neck-clamp mounting screw.
4. Set the game to display the self-test diagnostic pattern that shows a vertical and horizontal crosshatch with all three colors. This may appear as a white crosshatch pattern on the screen. (Refer to the Self-Test Procedures within the game manual for the details on selecting selftest diagnostic patterns.)
5. Preset the convergence magnets to superimpose the red, blue, and green lines at the center of the screen.
6. Set the game to display only the green crosshatch diagnostic pattern. If the game does not produce a green-only crosshatch pattern, turn off R DRIVE R364 and B-DRIVE R363 of the display CRT PCB. Refer to Figure 19 for the locations of the Drive controls.
7. Slide the deflection yoke toward the magnet assembly to produce a vertical green band within the center of the crosshatch pattern.
8. Adjust the purity rings of the magnet assembly shown in Figure 18 to center the green band horizontally on the face of the CRT.

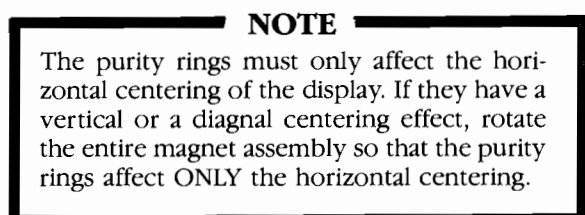

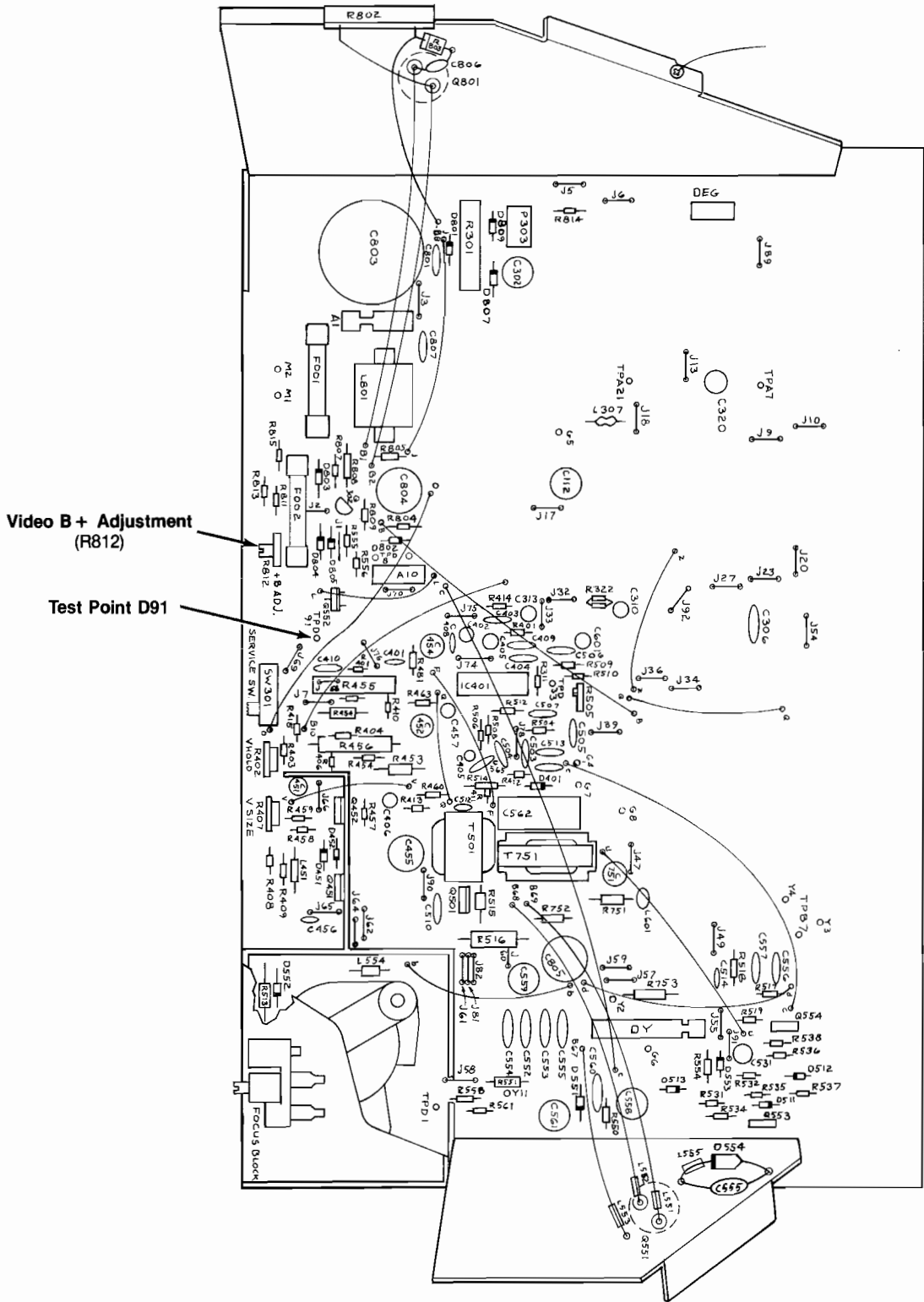

Figure 17 Locations of Video B+ Adjustment R812 and Test Point D91

9. Slowly slide the deflection yoke forward until the crosshatch pattern is all green. Tighten the yoke-mounting screw.
10. Set the game to display the self-test diagnostic pattern that shows a crosshatch pattern of all three colors.
11. Check the display for good overall purity.
12. Perform the convergence adjustments.

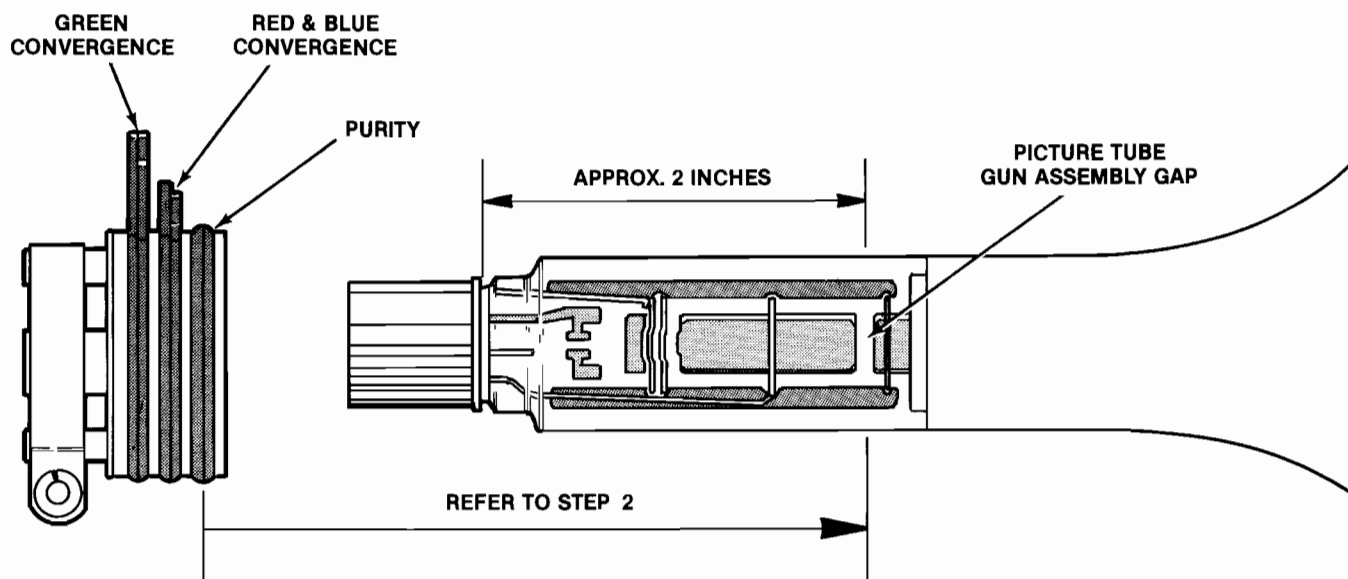

Figure 18 Purity and Convergence Adjustments

C. Convergence Adjustments

NOTE

If the purity adjustments have been performed, you must also perform the entire convergence adjustments procedure.

1. Adjust for static convergence, which aligns the registration of all three colors over the entire screen area, as follows:
 - a. Set the game to display the self-test diagnostic pattern that shows a crosshatch of all three colors. (This may appear as a white crosshatch pattern. Refer to the Self-Test Procedures within the game manual for the details on selecting self-test diagnostic patterns.)

- b. Adjust the angle of the tabs of the red and blue convergence magnets to superimpose the red and blue vertical lines in the center of the screen area. This will produce magenta vertical lines at screen center. These magnets are shown in Figure 18.

NOTE

Do not attempt to adjust the convergence of the outer areas of the screen at this time.

- c. Keeping their angles the same, rotate both tabs of these magnets to superimpose the red horizontal lines with the blue horizontal lines in the center of the screen area. This produces magenta horizontal lines at screen center.
- d. Adjust the angle between the tabs of the green convergence magnets to superimpose the green vertical lines with the magenta vertical lines already converged in the center of the screen.

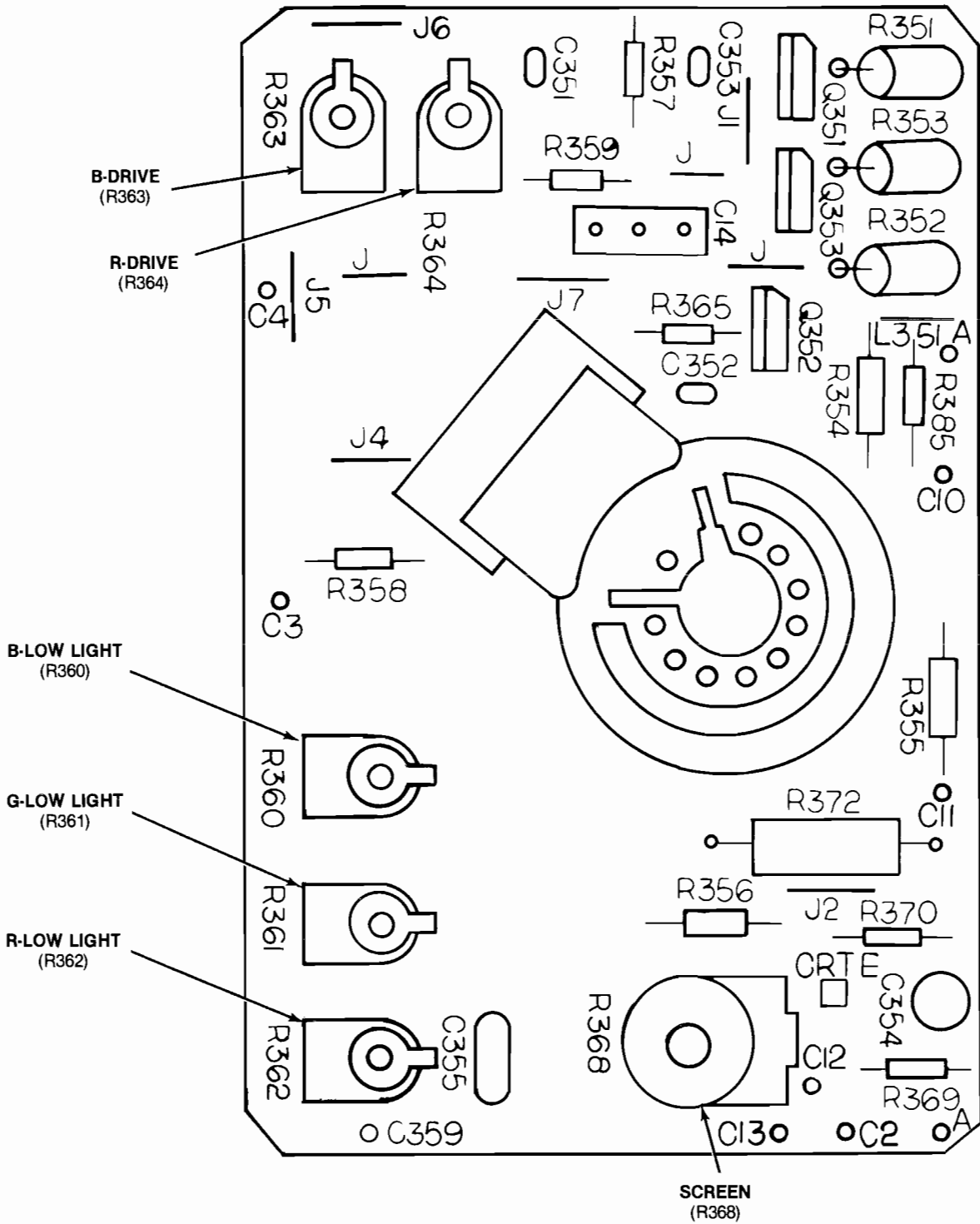

Figure 19 Locations of Tracking Adjustments on the CRT PCB

- e. Keeping the tab angles the same, rotate these rings to superimpose the green horizontal lines on the magenta horizontal lines already converged in the center of the screen.
2. Adjust for peripheral convergence, which aligns the registration of all three colors at the outer areas of the screen, as follows:
 - a. If not already done as part of the purity adjustments, loosen the screw securing the deflection yoke assembly to the neck of the cathode-ray tube. Remove the cloth tapes holding the three rubber wedges beneath the yoke. Use a razor blade or thin knife to loosen any glue securing the three rubber wedges to the CRT. Remove these wedges.
 - b. Tilt the deflection yoke in a vertical direction to superimpose the red horizontal lines with the blue and green horizontal lines at the 3 o'clock and 9 o'clock positions of the screen. This produces white horizontal lines.
 - c. While maintaining the vertical position of the yoke, tilt it in a horizontal direction to superimpose the red crosshatch with the blue and green crosshatch patterns at the 6 o'clock and 12 o'clock positions of the screen. This produces a white crosshatch pattern.
 - d. Install the three rubber wedges firmly beneath the yoke collar to hold the yoke in position. Recheck the convergence of the display. If necessary, repeat parts b and c of this step and the static convergence adjustments of step 1.
3. Secure the rings of the convergence-magnet assembly and the rubber yoke wedges with white glue. Replace the cloth tapes over the rubber wedges.
4. Tighten the deflection-yoke mounting screw.

D. Tracking Adjustments

1. Remove power from both the game and the display.
2. Unplug the 6-pin video-signal connector, which is wired to the Video Amplifier PCB.
3. Set R-DRIVE R364 and B-DRIVE R363 to their mechanical centers. Figure 19 shows the location of the tracking adjustments on the CRT PCB.
4. Set all three Low Light controls (R360, R361, and R362) fully counterclockwise.
5. Set SCREEN control R368 fully counterclockwise.
6. Apply power to the display.
7. Slowly adjust SCREEN control R368 until the CRT screen shows the first hint of color. Do not adjust the Low Light control for the color which first ap-

peared on the CRT screen. Slowly adjust the Low Light controls for the other two colors until the CRT screen is a faint grey. Now back off the SCREEN setting until the color just disappears.

8. Remove power from the display. Reconnect the 6-pin video-signal connector between the game and the display.
9. Reapply power to both the game and the display.
10. Set the game to display the self-test diagnostic pattern that shows a white crosshatch. (Refer to the Self-Test Procedures within the game manual for detailed procedures on selecting the self-test diagnostic patterns.)
11. Adjust R-DRIVE R364 and B-DRIVE R363 for a neutral white crosshatch pattern. If necessary, readjust SCREEN R368 for a proper black level.

E. Horizontal Oscillator Disable Test

1. Apply power to the display and the game.
2. Short across R802, shown in Figure 20, with a well-insulated jumper.
3. Check that the CRT picture is lost and that all high-voltages are lost.

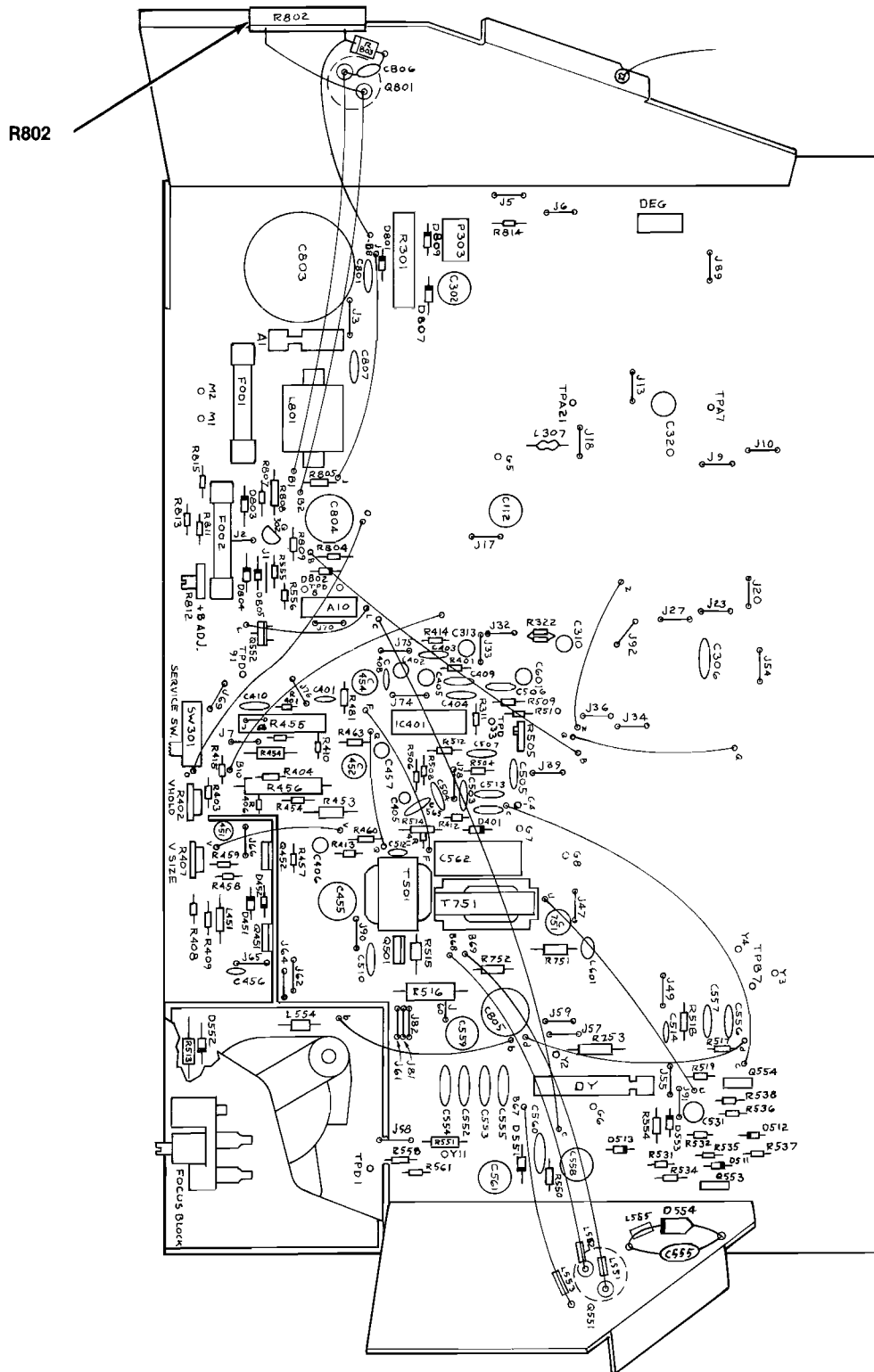
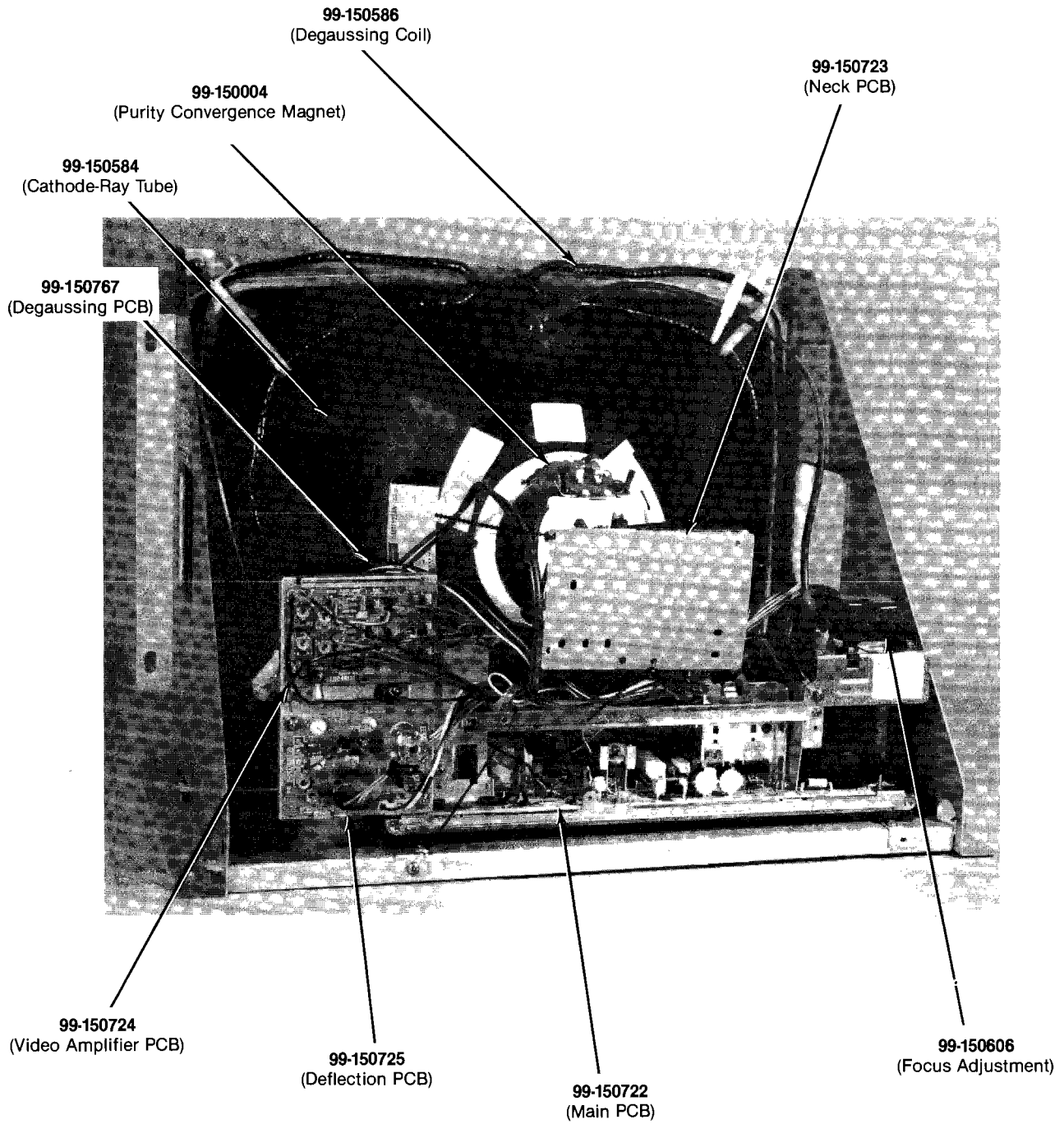

Figure 20 Location of R802 for Horizontal Oscillator Disable Test

8 Illustrated Parts Lists



**Figure 21 Display Assembly
139003-1004**

Figure 21 Display Assembly, continued Parts List

Components and assemblies listed in this Parts List are shown in Figure 21.

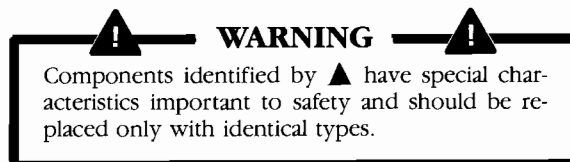

| <i>Designator</i> | <i>Description</i> | <i>Part No.</i> |
|---|--|------------------------|
| <i>Cathode-Ray Tube Assemblies</i> | | |
| L560 | ▲ Purity Convergence Magnet | 99-150004 |
| | ▲ Type-510TFB22AW 19-Inch Cathode-Ray Tube | 99-150584 |
| | ▲ Degaussing Coil | 99-150586 |
| | ▲ Deflection Coil | 99-150585 |
| <i>Printed Circuit Boards</i> | | |
| | Main PCB | 99-150722 |
| | Neck PCB | 99-150723 |
| | Video Amplifier PCB | 99-150724 |
| | Deflection PCB | 99-150725 |
| | Degaussing PCB | 99-150767 |
| <i>Resistors</i> | | |
| R560 | ▲ FOCUS Adjustment | 99-150606 |
| <i>Transistors</i> | | |
| Q451, Q452 | Type-2SC1683LB Vertical Output Transistor | 99-150562 |
| Q551 | Type-2SD649Q Horizontal Output Transistor | 99-150563 |
| Q801 | Type-2SD692 Video B+ Regulator Transistor | 99-150568 |

NOTICE TO ALL PERSONS RECEIVING THIS DRAWING
 CONFIDENTIAL: Reproduction forbidden without the specific written permission of Atari, Inc., Sunnyvale, CA. This drawing is only conditionally issued, and neither receipt nor possession thereof confers or transfers any right in, or license to use, the subject matter of the drawing or any design or technical information shown thereon, nor any right to reproduce this drawing or any part thereof. Except for manufacture by vendors of Atari, Inc., and for manufacture under the corporation's written license, no right to reproduce this drawing is granted or the subject matter thereof unless by written agreement with or written permission from the corporation

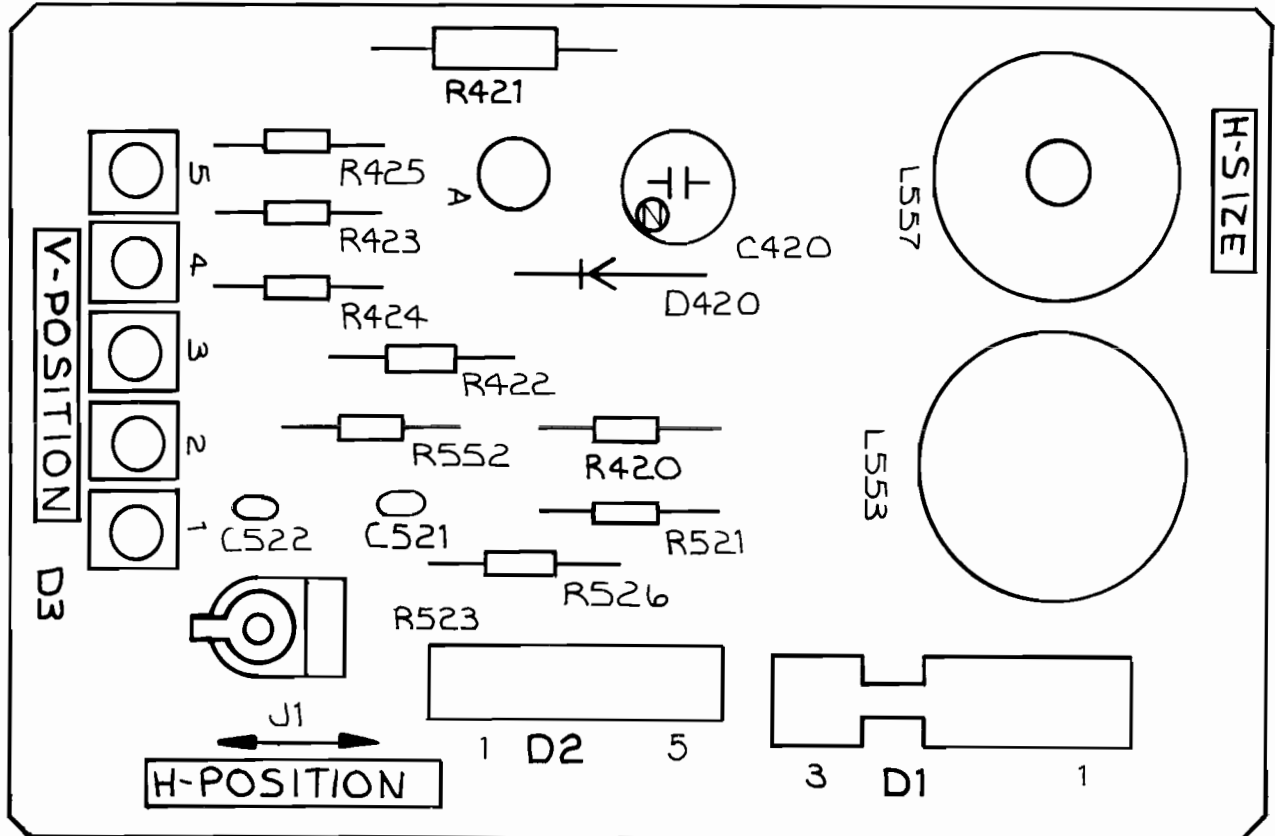
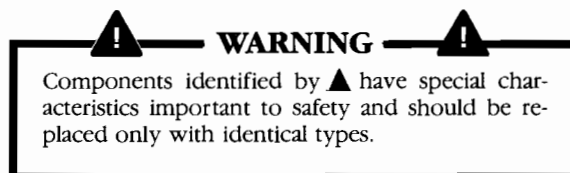

Figure 22 Deflection PCB
 99-150725 A

Figure 22 Deflection PCB, continued Parts List

Components listed in this Parts List are shown on Figure 22.



| <i>Designator</i> | <i>Description</i> | <i>Part No.</i> |
|-------------------|--|-----------------|
| Capacitors | | |
| C420 | 22 μ F, 25 V Aluminum Electrolytic Capacitor | 99-150689 |
| C521 | 1000 pF, $\pm 10\%$, 50 V Ceramic Capacitor | 99-150713 |
| C522 | 1800 pF, $\pm 10\%$, 50 V Ceramic Capacitor | 99-150705 |
| Coils | | |
| L553 | ▲ Linear Coil | 99-150589 |
| L557 | ▲ H-SIZE Coil | 99-150761 |
| Diodes | | |
| D420 | Type-TVSRM1ZM Silicon Diode | 99-150570 |
| Resistors | | |
| R420 | 56 Ω , $\pm 5\%$, $\frac{1}{2}$ W Carbon Resistor | 99-150627 |
| R421 | 330 Ω , $\pm 5\%$, 3 W Power Resistor | 99-150628 |
| R422 | 510 Ω , $\pm 5\%$, 2 W Power Resistor | 99-150629 |
| R423 | 200 Ω , $\pm 5\%$, $\frac{1}{2}$ W Carbon Resistor | 99-150630 |
| R424 | 620 Ω , $\pm 5\%$, $\frac{1}{2}$ W Carbon Resistor | 99-150631 |
| R425 | 1.8 k Ω , $\pm 5\%$, $\frac{1}{2}$ W Carbon Resistor | 99-150632 |
| R521 | 470 Ω , $\pm 5\%$, $\frac{1}{4}$ W Carbon Resistor | 99-150495 |
| R523 | 5 k Ω H-POSITION Adjustment | 99-150599 |
| R526 | 270 Ω , $\pm 5\%$, $\frac{1}{4}$ W Carbon Resistor | 99-150509 |
| R552 | 1 k Ω , $\pm 5\%$, $\frac{1}{4}$ W Carbon Resistor | 99-150488 |

Figure 23 Main PCB, continued Parts List

Components listed in this Parts List are shown on Figure 23.

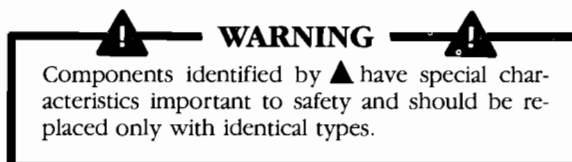

| <i>Designator</i> | <i>Description</i> | <i>Part No.</i> |
|-------------------|--|-----------------|
| <i>Capacitors</i> | | |
| C112 | 220 μ F, 16 V Aluminum Electrolytic Capacitor | 99-150673 |
| C306 | 0.1 μ F, $\pm 10\%$, 50 V Poly Capacitor | 99-150536 |
| C310 | 3.3 μ F, 50 V Aluminum Electrolytic Capacitor | 99-150674 |
| C320 | 100 μ F, 16 V Aluminum Electrolytic Capacitor | 99-150675 |
| C401 | 0.0047 μ F, $\pm 10\%$, 50 V Poly Capacitor | 99-150681 |
| C402 | 1 μ F, 50 V Aluminum Electrolytic Capacitor | 99-150313 |
| C403 | 0.027 μ F, $\pm 10\%$, 50 V Poly Capacitor | 99-150682 |
| C404 | 560 pF, $\pm 10\%$, 50 V Ceramic Capacitor | 99-150676 |
| C405 | 2.2 μ F, 25 V Tantalum Capacitor | 99-150684 |
| C406 | 1 μ F, 160 V Aluminum Electrolytic Capacitor | 99-150685 |
| C407 | 2700 pF, $\pm 10\%$, 50 V Poly Capacitor | 99-150719 |
| C408 | 0.01 μ F, $\pm 10\%$, 50 V Poly Capacitor | 99-150686 |
| C409 | 1000 pF, $\pm 10\%$, 50 V Poly Capacitor | 99-150687 |
| C410 | 100 pF, 50 V Ceramic Capacitor | 99-150688 |
| C451 | 10 μ F, 50 V Aluminum Electrolytic Capacitor | 99-150690 |
| C452 | 10 μ F, 100 V Aluminum Electrolytic Capacitor | 99-150691 |
| C454 | 220 μ F, 16 V Aluminum Electrolytic Capacitor | 99-150673 |
| C455 | 100 μ F, 100 V Aluminum Electrolytic Capacitor | 99-150692 |
| C456 | 0.0022 μ F, 200 V Poly Capacitor | 99-150693 |
| C457 | 10 μ F, 16 V Aluminum Electrolytic Capacitor | 99-150694 |
| C502 | 33 μ F, 16 V Tantalum Capacitor | 99-150695 |
| C503 | 2700 pF, $\pm 10\%$, 50 V Poly Capacitor | 99-150738 |
| C504 | 0.0027 μ F, $\pm 5\%$, 600 V Poly Capacitor | 99-150697 |
| C505 | 0.018 μ F, $\pm 10\%$, 50 V Poly Capacitor | 99-150698 |
| C506 | 1 μ F, 50 V Aluminum Electrolytic Capacitor | 99-150313 |
| C507 | 0.0068 μ F, $\pm 10\%$, 50 V Poly Capacitor | 99-150699 |
| C509 | 1800 pF, $\pm 10\%$, 50 V Ceramic Capacitor | 99-150700 |
| C510 | 2700 pF, $\pm 10\%$, 500 V Ceramic Capacitor | 99-150701 |
| C511 | 1 μ F, 50 V Aluminum Electrolytic Capacitor | 99-150702 |
| C512 | 1000 pF, 500 V Ceramic Capacitor | 99-150739 |
| C513 | 0.1 μ F, $\pm 10\%$, 50 V Poly Capacitor | 99-150536 |
| C514 | 82 pF, $\pm 5\%$, 50 V Ceramic Capacitor | 99-150720 |
| C531 | ▲ 10 μ F, 50 V Aluminum Electrolytic Capacitor | 99-150690 |
| C551 | ▲ 1500 pF, $\pm 10\%$, 2 kV Ceramic Capacitor | 99-150706 |
| C552-C555 | ▲ 2200 pF, $\pm 10\%$, 2 kV Ceramic Capacitor | 99-150707 |
| C556, C557 | ▲ 0.033 μ F, $\pm 10\%$, 100 V Poly Capacitor | 99-150708 |

[Continued on next page]

**Figure 23 Main PCB, continued
Parts List**

| <i>Designator</i> | <i>Description</i> | <i>Part No.</i> |
|-------------------------------------|--|-----------------|
| Capacitors, continued | | |
| C558 | ▲ 220 μ F, 35 V Aluminum Electrolytic Capacitor | 99-150309 |
| C559 | ▲ 4.7 μ F, 250 V Aluminum Electrolytic Capacitor | 99-150709 |
| C560 | 3300 pF, \pm 10%, 500 V Ceramic Capacitor | 99-150710 |
| C561 | ▲ 3.3 μ F, 160 V Aluminum Electrolytic Capacitor | 99-150711 |
| C562 | ▲ 0.47 μ F, 400 V Poly Capacitor | 99-150712 |
| C565 | 1000 pF, \pm 10%, 50 V Ceramic Capacitor | 99-150713 |
| C751 | 22 μ F, 25 V Aluminum Electrolytic Capacitor | 99-150714 |
| C801 | ▲ 1000 pF, 500 V Ceramic Capacitor | 99-150324 |
| C802 | ▲ 4.7 μ F, 250 V Aluminum Electrolytic Capacitor | 99-150709 |
| C803 | ▲ 800 μ F, 200 V Aluminum Electrolytic Capacitor | 99-150715 |
| C804 | 33 μ F, 160 V Capacitor | 99-150716 |
| C805 | ▲ 33 μ F, 160 V Aluminium Electrolytic Capacitor | 99-150551 |
| C806 | 0.068 μ F, \pm 10%, 100 V Ceramic Capacitor | 99-150717 |
| C807 | ▲ 470 pF, 200 V Ceramic Capacitor | 99-150718 |
| Coils and Ferrite Lead Beads | | |
| L451 | 1 μ H Ferrite Lead Bead | 99-150453 |
| L551, L552 | Ferrite Lead Bead | 99-150588 |
| L554 | 1 μ H Ferrite Lead Bead | 99-150741 |
| L555, L556 | Ferrite Lead Bead | 99-150588 |
| L601 | 1 μ H Peaking Coil | 99-150591 |
| L801 | ▲ Power Filter | 99-150592 |
| Diodes | | |
| D401 | Type-MA162TA5 Silicon Diode | 99-150729 |
| D451, D452 | Type-MA150TA Silicon Diode | 99-150103 |
| D511 | ▲ Type-MA150 Silicon Diode | 99-150571 |
| D512 | ▲ Type-TVSQA107RE Zener Diode | 99-150572 |
| D513 | ▲ Type-TVSRF1A Silicon Diode | 99-150766 |
| D551 | ▲ Type-TVSB2406C Silicon Diode | 99-150574 |
| D552 | ▲ Type-TVSB2406D Diode | 99-150767 |
| D553 | Type-MA162TA5 Silicon Diode | 99-150729 |
| D554 | Type-TVSMB1F Silicon Diode | 99-150577 |
| D801 | ▲ Type-TVSC0410 Diode | 99-150578 |
| D802 | Type-TVSRM25 Diode | 99-150579 |
| D803 | Type-TVSRM1ZM Diode | 99-150570 |
| D804 | ▲ Type-TVSQA111SE 11 V Zener Diode | 99-150581 |
| D805 | ▲ Type-MA26W0 Silicon Diode | 99-150104 |
| D807 | ▲ Type-TVSRM1ZM Silicon Diode | 99-150570 |
| D809 | ▲ Type-TVSRM2C Silicon Diode | 99-150583 |

[Continued on next page]

Main PCB, continued Parts List

| <i>Designator</i> | <i>Description</i> | <i>Part No.</i> |
|----------------------------|--|-----------------|
| Fuses | | |
| F001 | ▲ 125 V, 4 A, Slow-Blowing Fuse | 99-150597 |
| F002 | ▲ 125 V, 1.5 A, Slow-Blowing Fuse | 99-150598 |
| Integrated Circuits | | |
| IC401 | Horizontal Oscillator/Vertical Oscillator Integrated Circuit | 99-150561 |
| Resistors | | |
| D808 | ▲ Type-ERPF5B0M080F Posistor | 99-150582 |
| R322 | 180 Ω , $\pm 5\%$, $\frac{1}{4}$ W Carbon Resistor | 99-150609 |
| R401 | 3.3 k Ω , $\pm 5\%$, $\frac{1}{4}$ W Carbon Resistor | 99-150513 |
| R402 | 5 k Ω V-HOLD Adjustment | 99-150602 |
| R403 | 2.2 k Ω , $\pm 5\%$, $\frac{1}{4}$ W Carbon Resistor | 99-150522 |
| R404 | 10 k Ω , $\pm 5\%$, $\frac{1}{4}$ W Carbon Resistor | 99-150620 |
| R405 | 8.2 k Ω , $\pm 5\%$, $\frac{1}{4}$ W Carbon Resistor | 99-150621 |
| R406 | 2.2 k Ω , $\pm 5\%$, $\frac{1}{4}$ W Carbon Resistor | 99-150622 |
| R407 | 100 Ω V-SIZE Adjustment | 99-150603 |
| R408 | 68 Ω , $\pm 5\%$, $\frac{1}{4}$ W Carbon Resistor | 99-150623 |
| R409 | 10 Ω , $\pm 5\%$, $\frac{1}{2}$ W Carbon Resistor | 99-150624 |
| R410, R411 | 680 Ω , $\pm 5\%$, $\frac{1}{4}$ W Carbon Resistor | 99-150487 |
| R412 | 5.6 k Ω , $\pm 5\%$, $\frac{1}{4}$ W Carbon Resistor | 99-150485 |
| R413 | 2.2 k Ω , $\pm 5\%$, $\frac{1}{4}$ W Carbon Resistor | 99-150522 |
| R414 | 2.7 k Ω , $\pm 5\%$, $\frac{1}{4}$ W Carbon Resistor | 99-150625 |
| R415 | 100 Ω , $\pm 5\%$, $\frac{1}{4}$ W Carbon Resistor | 99-150626 |
| R451 | 10 k Ω , $\pm 5\%$, $\frac{1}{4}$ W Carbon Resistor | 99-150497 |
| R452 | 2.2 k Ω , $\pm 5\%$, $\frac{1}{4}$ W Carbon Resistor | 99-150484 |
| R453, R454 | 2.2 k Ω , $\pm 5\%$, 2 W Power Resistor | 99-150633 |
| R455 | ▲ 4.7 k Ω , $\pm 5\%$, 5 W Power Resistor | 99-150634 |
| R456 | 56 Ω , $\pm 5\%$, 2 W Power Resistor | 99-150737 |
| R457 | 10 Ω , $\pm 5\%$, $\frac{1}{4}$ W Carbon Resistor | 99-150636 |
| R458 | 2.7 Ω , $\pm 5\%$, $\frac{1}{4}$ W Carbon Resistor | 99-150637 |
| R459 | 100 k Ω , $\pm 5\%$, $\frac{1}{4}$ W Carbon Resistor | 99-150638 |
| R460 | 120 k Ω , $\pm 5\%$, $\frac{1}{4}$ W Carbon Resistor | 99-150639 |
| R461 | 82 Ω , $\pm 5\%$, $\frac{1}{4}$ W Carbon Resistor | 99-150502 |
| R463 | 4.7 k Ω , $\pm 5\%$, $\frac{1}{4}$ W Carbon Resistor | 99-150521 |
| R502 | 270 Ω , $\pm 5\%$, $\frac{1}{4}$ W Carbon Resistor | 99-150640 |
| R503 | 1 k Ω , $\pm 5\%$, $\frac{1}{4}$ W Carbon Resistor | 99-150641 |
| R504 | 10 k Ω , $\pm 5\%$, $\frac{1}{4}$ W Carbon Resistor | 99-150497 |
| R505 | 5 k Ω H-HOLD Adjustment | 99-150604 |
| R508 | 680 k Ω , $\pm 5\%$, $\frac{1}{4}$ W Carbon Resistor | 99-150642 |
| R509 | 33 k Ω , $\pm 5\%$, $\frac{1}{4}$ W Carbon Resistor | 99-150643 |
| R510 | 8.2 k Ω , $\pm 5\%$, $\frac{1}{4}$ W Carbon Resistor | 99-150644 |
| R511 | 680 k Ω , $\pm 5\%$, $\frac{1}{4}$ W Carbon Resistor | 99-150498 |
| R512 | 68 k Ω , $\pm 5\%$, $\frac{1}{4}$ W Carbon Resistor | 99-150645 |

[Continued on next page]

**Figure 23 Main PCB, continued
Parts List**

| <i>Designator</i> | <i>Description</i> | <i>Part No.</i> |
|-----------------------------|--|-----------------|
| Resistors, continued | | |
| R513 | ▲ 1 Ω , $\pm 5\%$, ½ W Carbon Resistor | 99-150209 |
| R514 | 3.9 k Ω , $\pm 5\%$, 1 W Power Resistor | 99-150646 |
| R515 | 0.27 Ω , $\pm 10\%$, ½ W Power Resistor | 99-150208 |
| R516 | ▲ 1.2 k Ω , $\pm 5\%$, 3 W Power Resistor | 99-150735 |
| R517 | 4.7 k Ω , $\pm 5\%$, ¼ W Carbon Resistor | 99-150521 |
| R518 | 12 k Ω , $\pm 5\%$, ¼ W Carbon Resistor | 99-150721 |
| R531 | ▲ 47 Ω , $\pm 5\%$, ¼ W Carbon Resistor | 99-150648 |
| R532 | ▲ 32.4 k Ω , $\pm 1\%$, ¼ W Power Resistor | 99-150649 |
| R534 | ▲ 68 k Ω , $\pm 5\%$, ¼ W Carbon Resistor | 99-150650 |
| R535 | ▲ 330 Ω , $\pm 5\%$, ¼ W Carbon Resistor | 99-150651 |
| R536 | ▲ 680 Ω , $\pm 5\%$, ¼ W Carbon Resistor | 99-150487 |
| R537 | ▲ 13.0 k Ω , $\pm 1\%$, ¼ W Power Resistor | 99-150652 |
| R538 | ▲ 18 k Ω , $\pm 5\%$, ¼ W Carbon Resistor | 99-150499 |
| R539 | ▲ 12 k Ω , $\pm 5\%$, ¼ W Carbon Resistor | 99-150721 |
| R550 | 100 Ω , $\pm 5\%$, ½ W Carbon Resistor | 99-150654 |
| R551 | ▲ 0.47 Ω , $\pm 10\%$, ½ W Carbon Resistor | 99-150655 |
| R553 | 22 k Ω , $\pm 5\%$, ½ W Carbon Resistor | 99-150656 |
| R554 | 82 k Ω , $\pm 5\%$, ½ W Carbon Resistor | 99-150657 |
| R555 | 390 Ω , $\pm 5\%$, ¼ W Carbon Resistor | 99-150658 |
| R556 | 15 Ω , $\pm 5\%$, 1 W Power Resistor | 99-150659 |
| R561 | 470 Ω , $\pm 5\%$, ¼ W Carbon Resistor | 99-150495 |
| R751 | 680 Ω , $\pm 5\%$, ½ W Carbon Resistor | 99-150660 |
| R752 | 1.8 k Ω , $\pm 5\%$, 1 W Power Resistor | 99-150661 |
| R753 | 680 Ω , $\pm 5\%$, 1 W Power Resistor | 99-150662 |
| R801 | ▲ 1.2 Ω , $\pm 10\%$, 7 W Power Resistor | 99-150663 |
| R802 | 200 Ω , $\pm 5\%$, 20 W Power Resistor | 99-150664 |
| R803 | 6.8 Ω , $\pm 10\%$, 3 W Power Resistor | 99-150665 |
| R804 | ▲ 12 k Ω , $\pm 5\%$, ¼ W Carbon Resistor | 99-150666 |
| R805 | ▲ 47 Ω , $\pm 5\%$, ¼ W Carbon Resistor | 99-150667 |
| R807 | 270 k Ω , $\pm 5\%$, ¼ W Carbon Resistor | 99-150668 |
| R808 | 15 k Ω , $\pm 5\%$, 1 W Power Resistor | 99-150669 |
| R809 | 15 Ω , $\pm 5\%$, ½ W Carbon Resistor | 99-150670 |
| R811 | ▲ 47 k Ω , $\pm 1\%$, ½ W Power Resistor | 99-150671 |
| R812 | ▲ 500 Ω VIDEO B + Adjustment | 99-150605 |
| R813 | ▲ 5.3 k Ω , $\pm 1\%$, ¼ W Power Resistor | 99-150672 |
| R814 | 220 k Ω , $\pm 5\%$, ¼ W Carbon Resistor | 99-150527 |
| R815 | ▲ 270 Ω , $\pm 5\%$, ¼ W Carbon Resistor | 99-150509 |

Switches

| | | |
|-------|----------------|-----------|
| SW301 | Service Switch | 99-150596 |
|-------|----------------|-----------|

[Continued on next page]

**Figure 23 Main PCB, continued
Parts List**

| <i>Designator</i> | <i>Description</i> | <i>Part No.</i> |
|---------------------|---|-----------------|
| Transformers | | |
| T501 | Horizontal Drive Transformer | 99-150593 |
| T551 | ▲ Flyback Transformer | 99-150594 |
| T751 | ▲ Pincushion Transformer | 99-150595 |
| Transistors | | |
| Q501 | Type-2SC1905HLB Horizontal Drive Transistor | 99-150565 |
| Q552 | Type-2SC1226 12 V Regulator Transistor | 99-150564 |
| Q553 | ▲ Type-2SD637 Horizontal Disable Amplifier Transistor | 99-150566 |
| Q554 | ▲ Type-2SB642 Horizontal Oscillator Disable Output Transistor | 99-150567 |
| Q802 | Type-2SC1473PNC Reference Amplifier Transistor | 99-150765 |

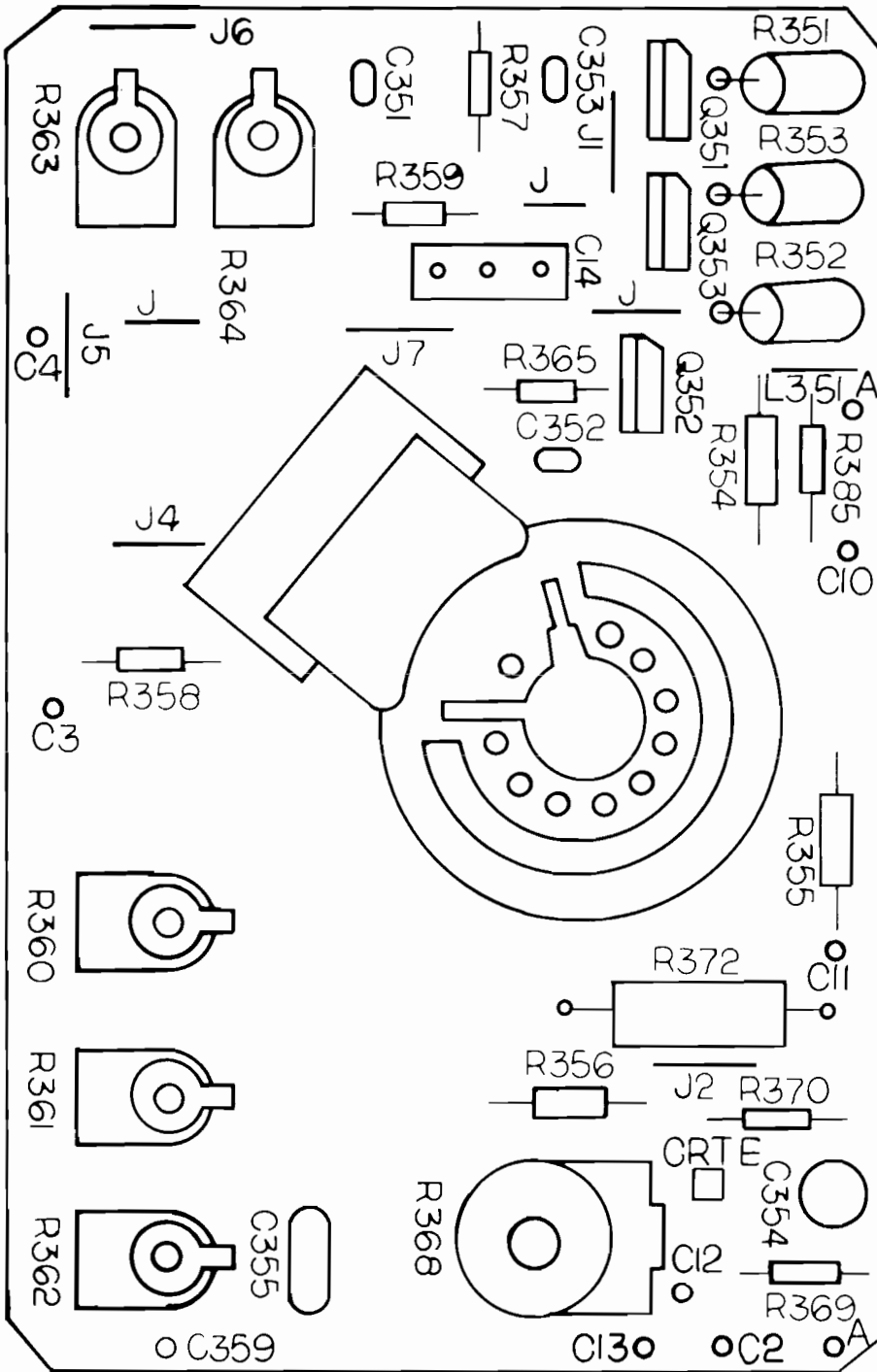

NOTICE TO ALL PERSONS RECEIVING THIS DRAWING
 CONFIDENTIAL: Reproduction forbidden without the specific written permission of Arai, Inc., Sunnyvale, CA. This drawing is only conditionally issued, and neither receipt nor possession thereof confers or transfers any right in, or license to use, the subject matter of the drawing or any design or technical information shown thereon, nor any right to reproduce this drawing or any part thereof. Except for manufacture by vendors of Arai, Inc., and for manufacture under the corporation's written license, no right to reproduce this drawing is granted or written permission thereof unless by written agreement with or written permission from the corporation.

Figure 24 Neck PCB
99-150723 A

Figure 24 Neck PCB, continued Parts List

Components listed in this Parts List are shown in Figure 24.

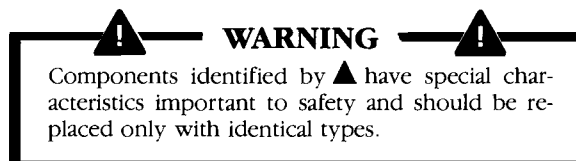

| <i>Designator</i> | <i>Description</i> | <i>Part No.</i> |
|--------------------|--|-----------------|
| Capacitors | | |
| C351 | 470 pF, ± 10%, 50 V Ceramic Capacitor | 99-150677 |
| C352 | 820 pF, ± 10%, 50 V Ceramic Capacitor | 99-150680 |
| C353 | 680 pF, ± 10%, 50 V Ceramic Capacitor | 99-150678 |
| C354 | 3.3 μF, 25 V Aluminum Electrolytic Capacitor | 99-150304 |
| C355 | 2200 pF, ± 10%, 2 kV Ceramic Capacitor | 99-150754 |
| Resistors | | |
| R351–R353 | 4.7 kΩ, ± 5%, 2 W Power Resistor | 99-150752 |
| R354–R356 | 2.7 kΩ, ± 5%, ½ W Carbon Resistor | 99-150613 |
| R357–R359 | 560 Ω, ± 5%, ¼ W Carbon Resistor | 99-150614 |
| R360 | 5 kΩ B-LOW LIGHT Adjustment | 99-150599 |
| R361 | 5 kΩ G-LOW LIGHT Adjustment | 99-150599 |
| R362 | 5 kΩ R-LOW LIGHT Adjustment | 99-150599 |
| R363 | 300 Ω B-DRIVE Adjustment | 99-150600 |
| R364 | 300 Ω R-DRIVE Adjustment | 99-150600 |
| R365 | 220 Ω, ± 5%, ¼ W Carbon Resistor | 99-150607 |
| R368 | 4 MΩ SCREEN Adjustment | 99-150601 |
| R369 | 470 kΩ, ± 5%, ¼ W Carbon Resistor | 99-150616 |
| R370 | 12 kΩ, ± 5%, ¼ W Carbon Resistor | 99-150617 |
| R372 | ▲ 2.7 Ω, ± 5%, 2 W Power Resistor | 99-150618 |
| R385 | 120 kΩ, ± 5%, ¼ W Carbon Resistor | 99-150619 |
| Sockets | | |
| (J4) | CRT Socket | 99-150008 |
| Transistors | | |
| Q351 | Type-2SC2923RL CRT Blue Drive Transistor | 99-150560 |
| Q352 | Type-2SC2923RL CRT Green Drive Transistor | 99-150560 |
| Q353 | Type-2SC2923RL CRT Red Drive Transistor | 99-150560 |

NOTICE TO ALL PERSONS RECEIVING THIS DRAWING
 CONFIDENTIAL: Reproduction forbidden without the specific written permission of Atari, Inc., Sunnyvale, CA. This drawing is only conditionally issued, and neither receipt nor possession thereof confers or transfers any right in, or license to use, the subject matter of the drawing or any design or technical information shown thereon, nor any right to reproduce this drawing or any part thereof. Except for manufacture by vendors of Atari, Inc., and for manufacture under the corporation's written license, no right to reproduce this drawing is granted or the subject matter thereof unless by written agreement with or written permission from the corporation

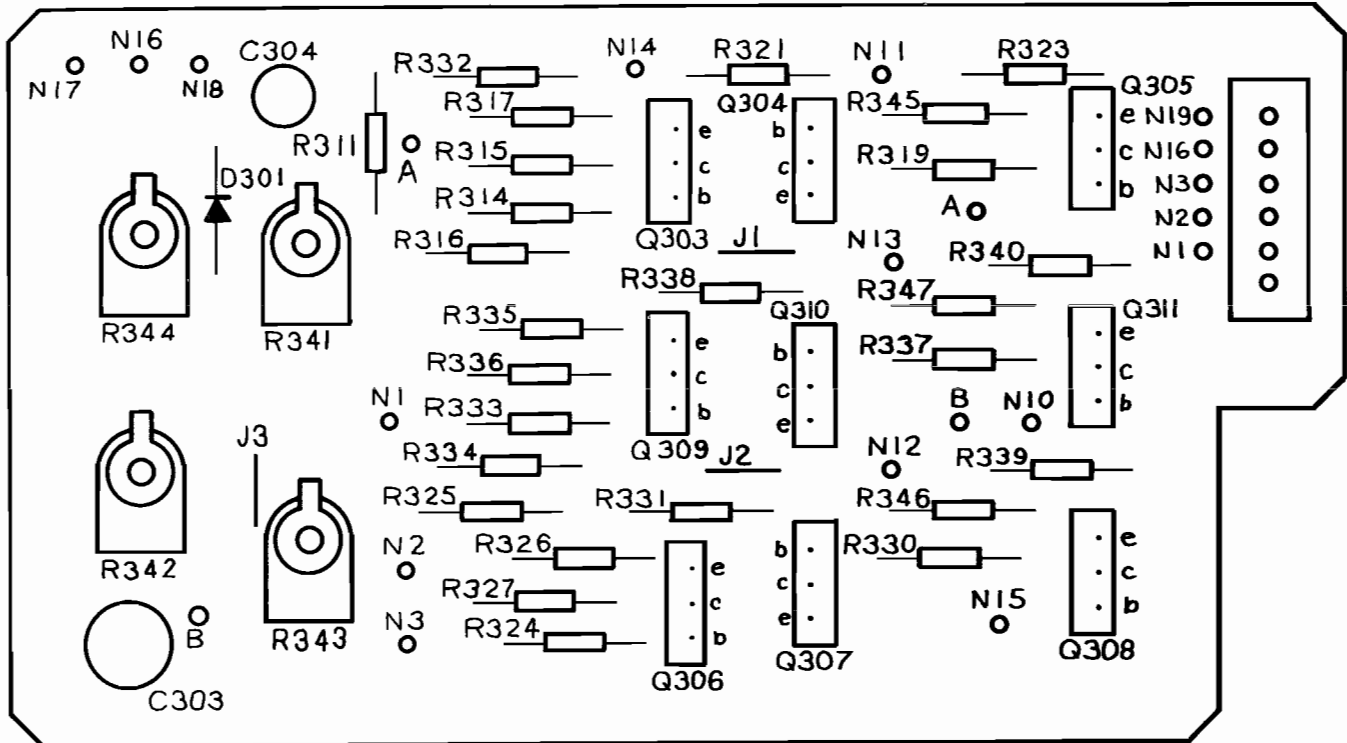
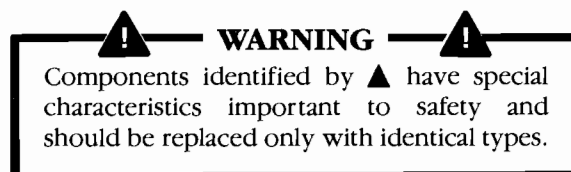

Figure 25 Video Amplifier PCB
 99-150724 A

Figure 25 Video Amplifier PCB, continued Parts List

Components listed in this Parts List are shown in Figure 25.



| <i>Designator</i> | <i>Description</i> | <i>Part No.</i> |
|-------------------|--|-----------------|
| Capacitors | | |
| C303 | 22 μ F, 16 V Aluminum Electrolytic Capacitor | 99-150673 |
| C304 | 10 μ F, 16 V Aluminum Electrolytic Capacitor | 99-150530 |
| Diodes | | |
| D301 | Type-MA162TA5 Silicon Diode | 99-150729 |
| Resistors | | |
| R311 | 22 k Ω , \pm 5%, 1/4 W Carbon Resistor | 99-150484 |
| R314 | 390 Ω , \pm 5%, 1/4 W Carbon Resistor | 99-150658 |
| R315 | 2.2 k Ω , \pm 5%, 1/4 W Carbon Resistor | 99-150522 |
| R316 | 680 Ω , \pm 5%, 1/4 W Carbon Resistor | 99-150487 |
| R317 | 390 Ω , \pm 5%, 1/4 W Carbon Resistor | 99-150658 |
| R319 | 2.7 k Ω , \pm 5%, 1/4 W Carbon Resistor | 99-150486 |
| R321 | 5.6 k Ω , \pm 5%, 1/4 W Carbon Resistor | 99-150485 |
| R323 | 560 Ω , \pm 5%, 1/4 W Carbon Resistor | 99-150523 |
| R324 | 390 Ω , \pm 5%, 1/4 W Carbon Resistor | 99-150658 |
| R325 | 680 Ω , \pm 5%, 1/4 W Carbon Resistor | 99-150487 |
| R326 | 390 Ω , \pm 5%, 1/4 W Carbon Resistor | 99-150658 |
| R327 | 2.2 k Ω , \pm 5%, 1/4 W Carbon Resistor | 99-150522 |
| R330 | 2.7 k Ω , \pm 5%, 1/4 W Carbon Resistor | 99-150486 |
| R331 | 5.6 k Ω , \pm 5%, 1/4 W Carbon Resistor | 99-150485 |
| R332 | 1 k Ω , \pm 5%, 1/4 W Carbon Resistor | 99-150488 |
| R333 | 390 Ω , \pm 5%, 1/4 W Carbon Resistor | 99-150658 |
| R334 | 680 Ω , \pm 5%, 1/4 W Carbon Resistor | 99-150487 |
| R335 | 390 Ω , \pm 5%, 1/4 W Carbon Resistor | 99-150658 |
| R336 | 2.2 k Ω , \pm 5%, 1/4 W Carbon Resistor | 99-150522 |
| R337 | 2.7 k Ω , \pm 5%, 1/4 W Carbon Resistor | 99-150486 |
| R338 | 5.6 k Ω , \pm 5%, 1/4 W Carbon Resistor | 99-150485 |
| R339, R340 | 560 Ω , \pm 5%, 1/4 W Carbon Resistor | 99-150523 |
| R341 | 5 k Ω RED CONTRAST Adjustment | 99-150599 |
| R342 | 5 k Ω GREEN CONTRAST Adjustment | 99-150599 |

[Continued on next page]

**Figure 25 Video Amplifier PCB, continued
Parts List**

| <i>Designator</i> | <i>Description</i> | <i>Part No.</i> |
|--------------------|--|-----------------|
| R343 | 5 k Ω BLUE CONTRAST Adjustment | 99-150599 |
| R344 | 10 k Ω BRIGHT Adjustment | 99-150726 |
| R345-R347 | 330 Ω , $\pm 5\%$, $\frac{1}{4}$ W Carbon Resistor | 99-150651 |
| Transistors | | |
| Q303-311 | Type-2SC1685 Video Amplifier Transistor | 99-150756 |

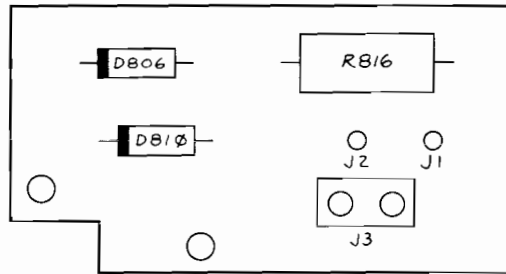

**Figure 26 Degaussing PCB
99-150767 A**

**Degaussing PCB
Parts List**

Components listed in this Parts List are shown in Figure 26.

! WARNING !

Components identified by ▲ have special characteristics important to safety and should be replaced only with identical types.

| <i>Designator</i> | <i>Description</i> | <i>Part No.</i> |
|-------------------|---|-----------------|
| Diodes | | |
| D806 | ▲ Type-TVSRM1ZM Silicon Diode | 99-150570 |
| D810 | ▲ Type-TVSRM1ZM Silicon Diode | 99-150570 |
| Resistors | | |
| R816 | ▲ 68 Ω , $\pm 10\%$, 5 W Wirewound Resistor | 99-150749 |

YOUR COMMENTS, PLEASE!

Matsushita Color Display
1st printing

Your comments will assist Atari in improving our publications. The comments are an important part of preparing for revisions of game manuals. Please write in the space below. No postage stamp is necessary if mailed in the U.S.A.

If you have any technical questions about certain ATARI games products, or are requesting additional publications, we will immediately forward your note to the appropriate person.

Page: Comments:



Fill in if you wish a reply:

Name _____

Firm _____

Address _____

City _____ State _____ Zip _____

Area Code _____ Phone _____

Distributor

Operator

Other _____

First fold



No Postage
Necessary
if mailed in
the United States

BUSINESS REPLY MAIL
FIRST CLASS PERMIT NO. 1004 SUNNYVALE, CA

POSTAGE WILL BE PAID BY ADDRESSEE

Atari, Inc.
Attn.: Field Service/Coin-Op Division
P. O. Box 427
Sunnyvale, California 94086



Second fold

From:

Tape this edge

YOUR COMMENTS, PLEASE!

Your comments will assist Atari in improving our publications. The comments are an important part of preparing for revisions of game manuals. Please write in the space below.

If you have any technical questions about certain ATARI games products, or are requesting additional publications, we will immediately forward your note to the appropriate person.

Page: Comments:

Fill in if you wish a reply:

Name _____

Firm _____

Address _____

City _____ Country _____

Phone: Country Code _____ Local Number _____

Distributor

Operator

Other _____

First fold

Attach
Necessary
Postage

Atari Ireland Limited
Attn.: Field Service/Coin-Op Division
Tipperary Town, Ireland

Second fold

From:



Tape this edge

If reading through this manual does not lead to solving a certain maintenance problem, call TELEHELP® at the Atari Customer Service office in your geographical area, as shown below.

WEST and CENTRAL U.S.A.

Parts and Service

Atari, Inc.
California Customer Service Office
1105 N. Fair Oaks Avenue
P. O. Box 427, Sunnyvale, CA 94086
Telex 17-1103
(Monday-Friday, 7:30-4:00 pm Pacific Time)

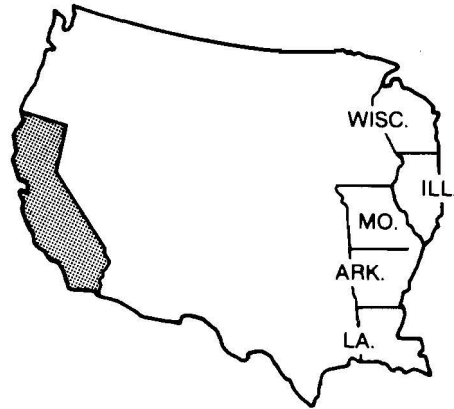

-  From California, Alaska, or Hawaii
(408) 745-2900
-  Service from anywhere in the area shown in white
toll-free (800) 538-1611



EAST U.S.A.

Service only

Atari, Inc.
New Jersey Customer Service Office
12A World's Fair Drive, Somerset, NJ 08873
Telex 37-9347
(Monday-Friday, 7:30-4:00 pm Eastern time)

-  From New Jersey
(201) 469-5993
-  From anywhere else in this area
toll-free (800) 526-3849



EUROPE

Parts and Service

Atari Ireland Limited
European Customer Service Office
Tipperary Town, Ireland
Telex 28165
(Monday-Friday, 9:00-6:00 pm GMT)

-  062-52155

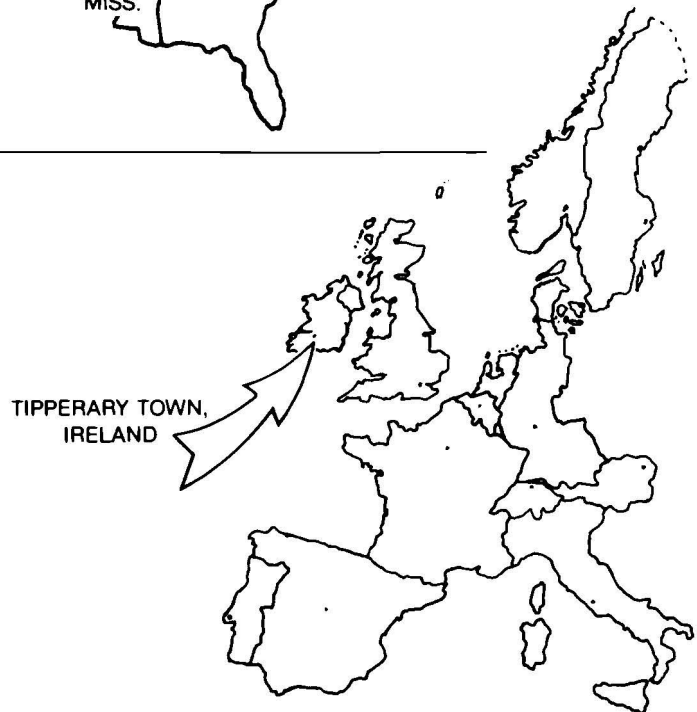

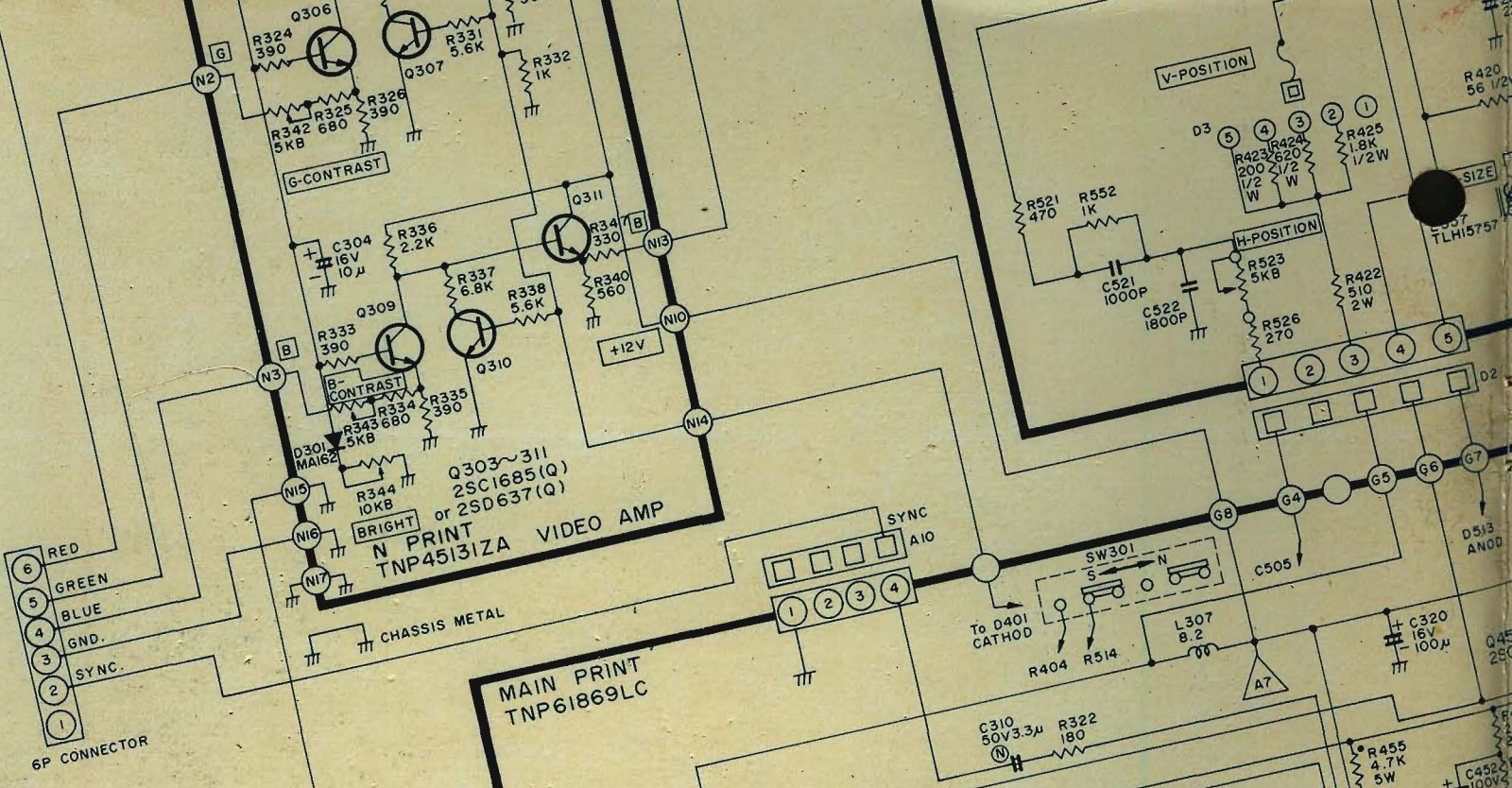

- 6 RED
 - 5 GREEN
 - 4 BLUE
 - 3 GND.
 - 2 SYNC.
 - 1
- 6P CONNECTOR

MAIN PRINT
TNP61869LC

IC 401
ENI1235
H-OSC
H-PREDRIVE
V-OSC DRIVE

Q801
2SD692
or 2SC1629A
AVR

Q802
2SC1473NC
or 2SC1573
or 2SC1941
REF AMP

Q554
2SB642-Q
or 2SA564A-Q
H OSC
DISABLE
OUT

H OSC
DISABLE
AMP

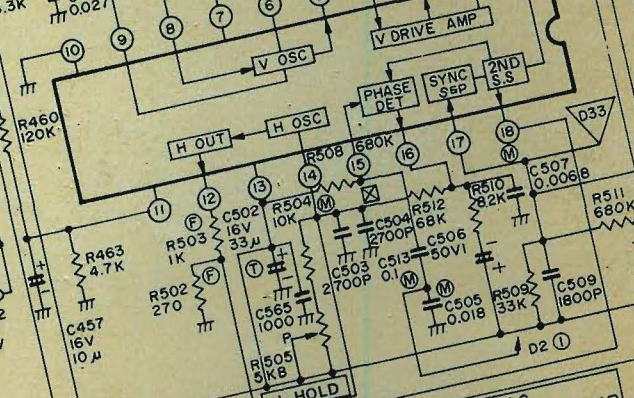

ATARI INC.
790 SYCAMORE DRIVE
P.O. BOX 906
MILPITAS, CALIFORNIA 95035
408/942-3100 • TELEX 35-7488