

SERVICE MANUAL
up to date: April 1984 (subject to modification)



Electronic
Equipment
Manufacturer

HANTAREX U.S.A. LTD.

127 Prospect Avenue - DOUGLASTON - New York 11363

tel. (212) 423-2672/423-2915 - telex 7105822453



color monitor 19"

MTC 9000/E U.S.A.

horizontal and vertical

THIS IS AN ADDITION TO THE PART LIST

LINE UNIT HEAT SINK ASSEMBLY
CODE 62000613

CODE	DESCRIPTION	REF NO.	QTY
20430200	TRANS. BU208A	TR17	1
22621000	WIRE WOUND RES.15W 10% 15	R98	1
34020211	SOCKET TO3 HANT.		1
40029010	SELF TAPPING SCREW 2,9X10TCC		1
40029014	SELF TAPPING SCREW 2,9X14TCC		1
42000070	WASHER 3,2X6		2
43000040	SPRING FOR RES.		2
50110550	HEAT SINK VTH16		1
50420180	INSULATOR 2000V		1
50420231	TO3 COVER		1

THIS MANUAL IS VALID FOR BOTH 13" AND 19" MONITORS
WITH THE EXCEPTION OF PICTURE TUBES.

MTC 900/E U.S.A. horizontal mod.: front and rear view	pag. 3
MTC 900/E U.S.A. vertical mod.: front and rear view	pag. 4
Warning	pag. 5
Protection against X-ray radiation	pag. 5
Operating Instructions and Data	pag. 6
Data Sheet	pag. 7
Setting-up Procedure	pag. 8
Adjusting Trimmers	pag. 9
Connection Diagram	pag. 10
Mechanical Data	pag. 11
Horizontal Combination IC Philips TDA 2593	pag. 12
Vertical Deflection IC Philips TDA 2653 A	pag. 13
Static Convergence Rings	pag. 14
K 190E Color Generator	pag. 15
Waveform	pag. 15
Printed Circuit Board	pag. 16
Schematic Diagram	pag. 18
Monitor Parts List	pag. 20



HANTAREX U.S.A. LTD.

127 Prospect Avenue – DOUGLASTON – New York 11363
tel. (212) 423-2672/423-2915 - telex 7105822453

X-RAY RADIATION
according to DHHS - U.S.A.
21 CFR SUBCHAPTER J Section 1002.111

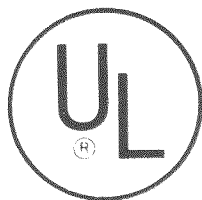
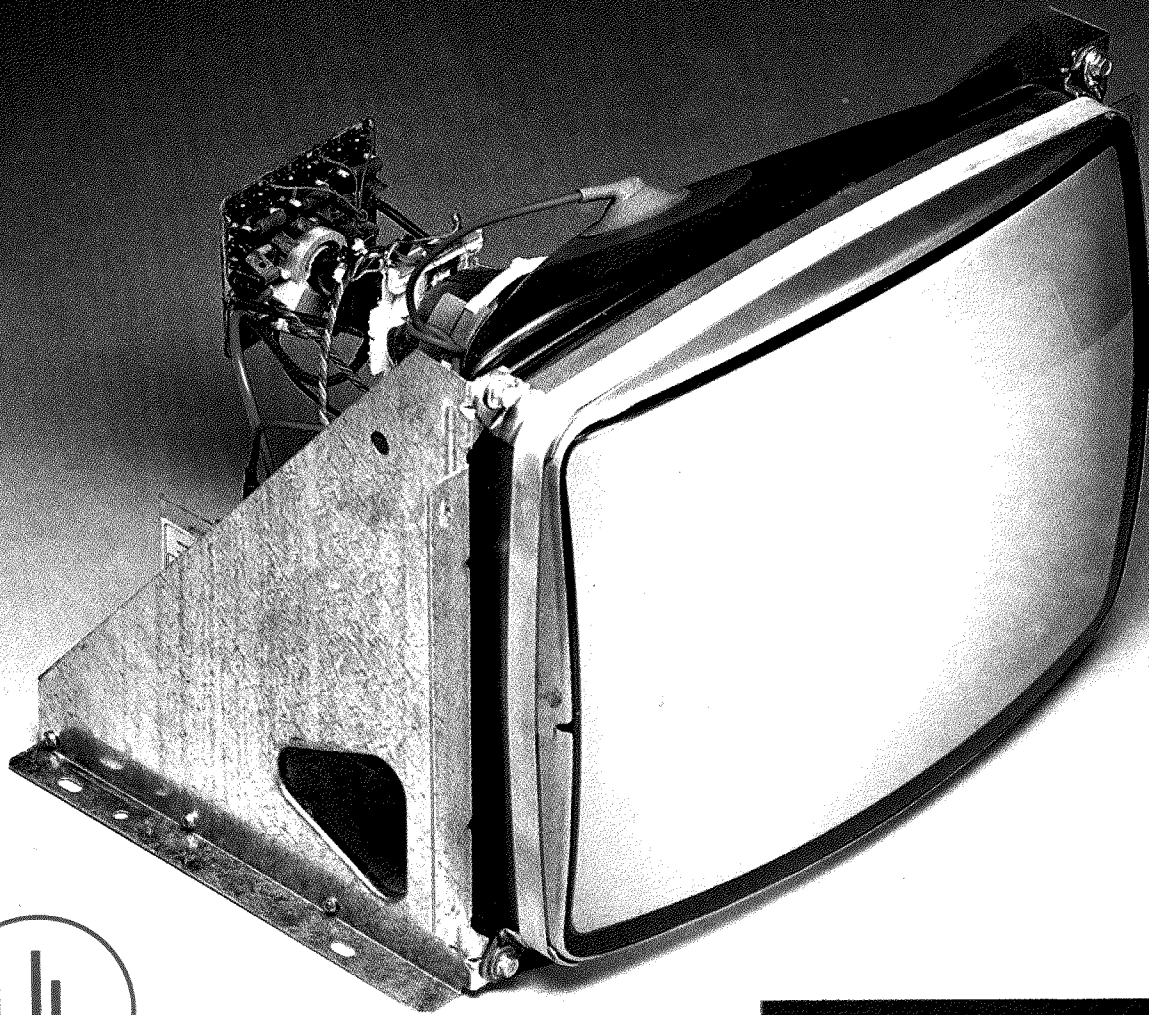

LISTED

color monitor 19"
MTC 9000/E U.S.A.
horizontal

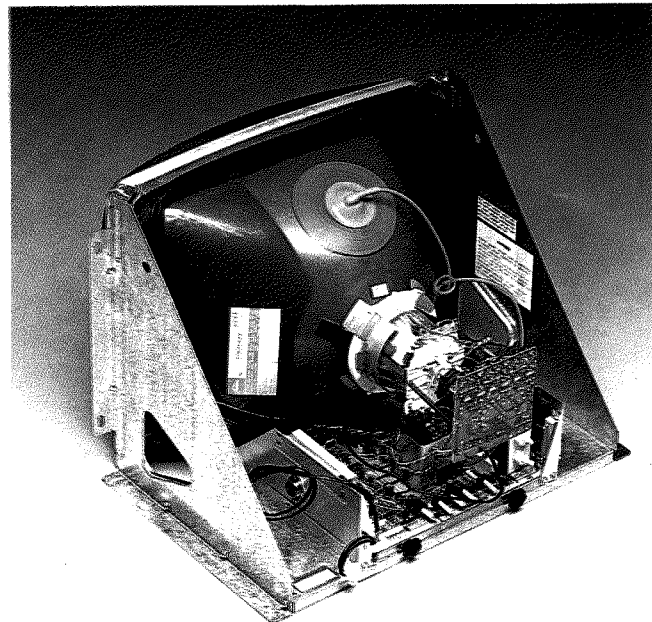

X-RAY RADIATION
according to DHHS - U.S.A.
(21 CFR SUBCHAPTER J Section 1002.11)

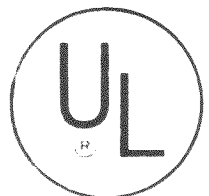
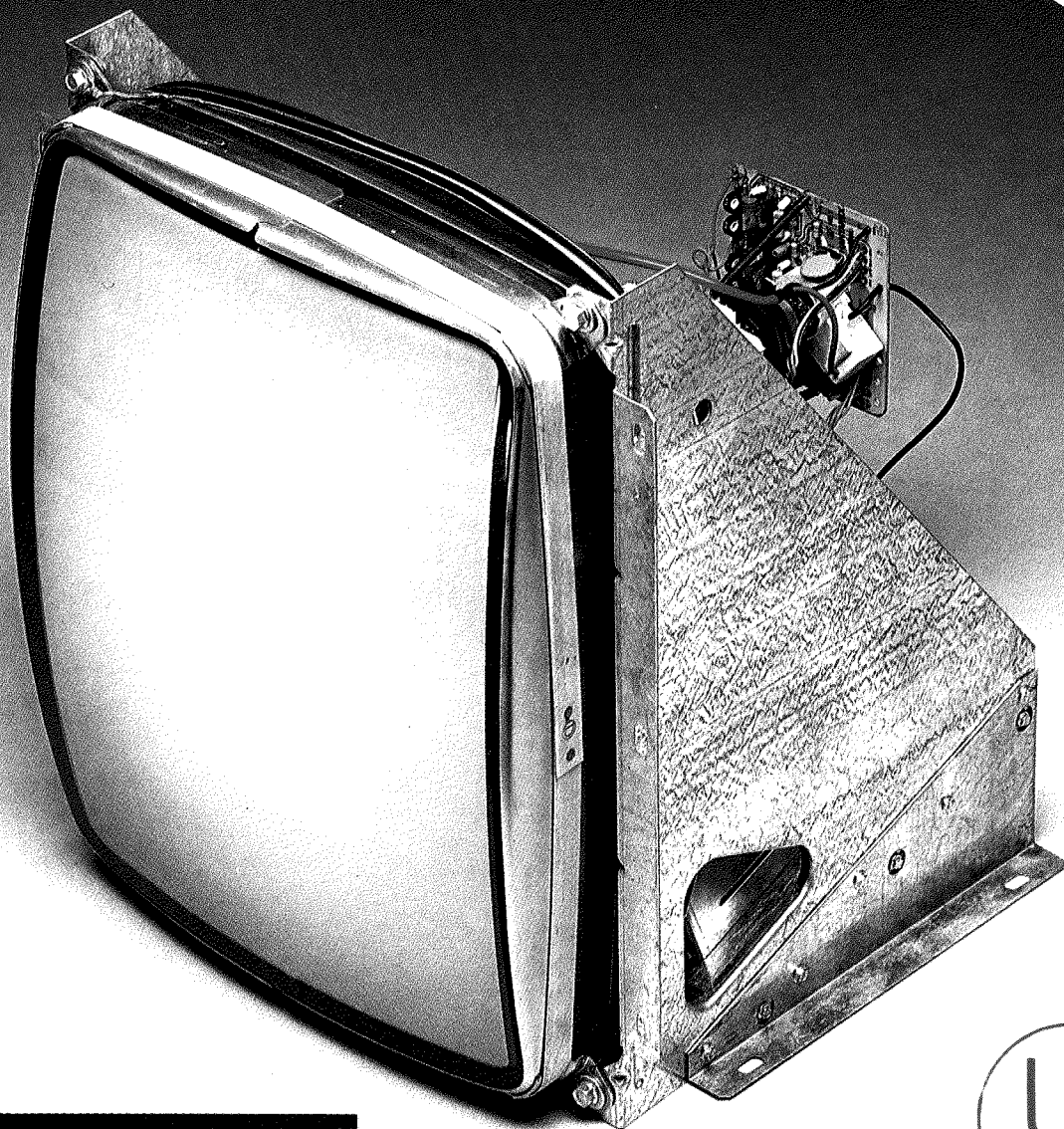

LISTED

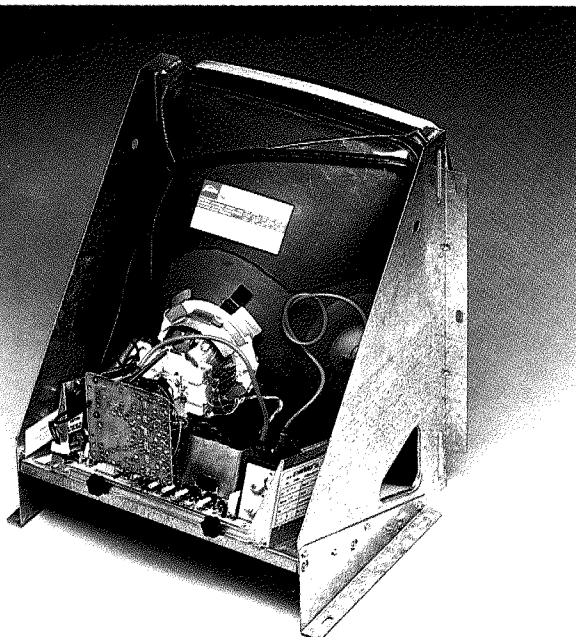

color monitor 19"
MTC 900/E U.S.A.
vertical

WARNING

The chassis and the heat sinks are connected to ground. Hence, for the measurement of voltages, connect the negative terminal of the measuring instrument to the chassis.

- **X-RAYS**
the chassis has been designed to give the minimum of x-ray radiation and a special safety circuit guarantees that even in the event of failure radiation will never exceed 0.5 mR/h. For this reason it is essential not to alter the C.R.T. circuit in any way.
- **E.H.T.**
The monitor embodies sources of high voltage capable of delivering **LETHAL** amounts of energy. Hence to avoid harm to the operator, follow precautions set down for the servicing of E.H.T. equipment.
- **C.R.T.**
The cathode-ray tube is a high vacuum component and its surfaces are subjected to strong exterior pressure. One therefore must take care not to knock or scratch the tube as this could cause implosion. It follows that the personnel responsible for its installation must use glasses and protective clothing against flying splinters.
- **SHOCK**
To prevent the possibility of electrical discharges do not expose the monitor to rain or humidity.

PROTECTION AGAINST X-RAY RADIATION

(patent n° 91830158.4)

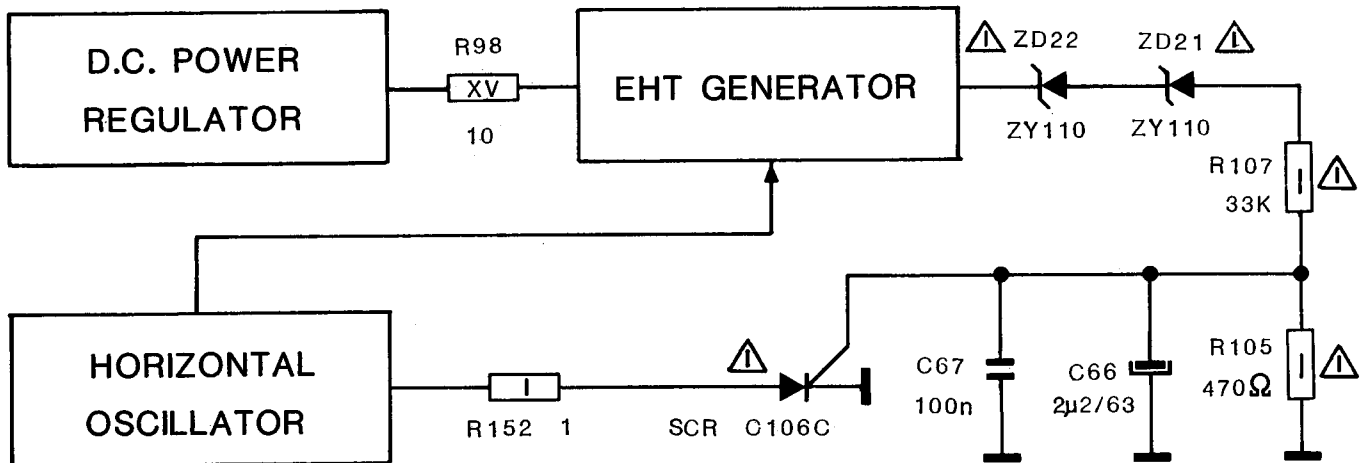

PROTECTION CIRCUIT

MTC 900/E includes an "X ray radiation" protection circuit. A reference voltage taken from the secondary of the E.H.T. transformer is fed via a resistive voltage divider to the gate of an S.C.R.

When the EHT voltage becomes more than 28,5 Kv, the reference voltage at the S.C.R. gate will increase sufficiently to fire the SCR which stops the Horizontal oscillator and therefore the generation of EHT.

The circuit continues blocking the oscillation until the break down has been repaired and the supply reset.

OPERATING INSTRUCTIONS

- 1) Apply a suitable power source to the monitor through an isolation transformer by means of J1
- 2) Apply a suitable signal source to the monitor by mean of connector CA
- 3) **SET UP CONTROLS**
All controls are preset at the factory, but may be adjusted to suit program material, please refer to page 8 (SETTING UP PROCEDURE)
- 4) For negative input $\overline{\text{SYNC}}$. Pulses use connector CC
pin n° 2 for $\overline{\text{VERT.}}$
pin n° 3 for $\overline{\text{HOR.}}$

PERFORMANCE AND OPERATING DATA

1) SUPPLY	min	max
VOLTAGE	98 Vac	130 Vac
FREQUENCY	44 Hz	65 Hz

NOTE: apply supply voltage through an isolation transformer with 1.5A capability

- 2) **HIGH VOLTAGE**
for 19" models 22,5 kV – 25,5 kV

NOTE: conditions for above:

I (beam) = 0 mA
DC supply voltage = 1.15 VDC

3) INPUT SIGNAL AND PIN ASSIGNMENTS FOR CONNECTOR CA

PIN N	DESCRIPTION	IMPEDANCE	SIGNAL
1	red input	1k nom.	0 to 4V
2	green input	1k nom.	0 to 4V
3	blue input	1k nom.	0 to 4V
4	ground		
5	vertical sync. pulse	10k nom.	1,5V to 4V
6	horizontal sync. pulse	10k nom.	1,5V to 4V

4) SERVICE SET-UP CONTROLS

ON THE INTERFACE BOARD

RV 12 supply voltage adjustment – set to 115Vdc
RV 10 brightness control
RV 1,2,3 contrast

ON THE DEFLECTION BOARD

RV 13 horizontal frequency
RV 14 horizontal phase
RV 23 vertical shift
RV 17 vertical linearity
RV 15 vertical hold control
RV 16 vertical amplitude
B 4 linearity coil
B 5 width coil

ON THE EHT TRANSFORMER

— G2 – brightness preset control
— focus control

ON THE SOCKET BOARD

video drive controls – “gain”
RV4; RV6; RV8
CRT cut-off controls – “black level”
RV5; RV7; RV9

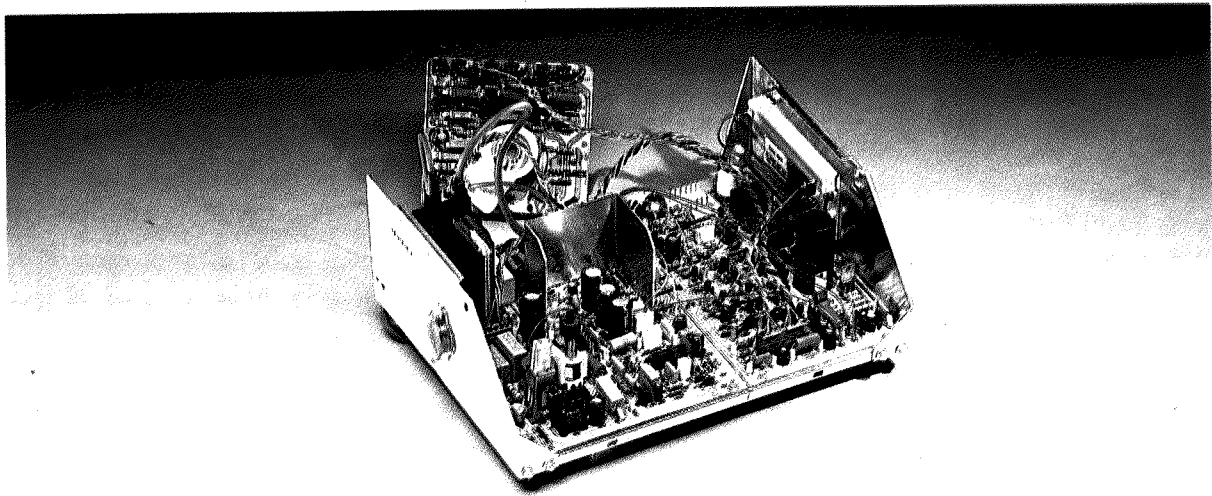

DESCRIPTION		MIN	TYP	MAX	UNITS
Supply					
INPUT ac	monitor input-with isolation transformer	98	117	130	Vac
POWER			110		W
DEGAUSSING	automatic		117		Vac
Interface RGB Analog Signal TTL compatible					
VID. SIGN. INPUT	RGBsignal:	1	4	5,5	Vpp
SYNC. INPUT	TTL compatible separate horizontal and vertical or composite (H+V) positive or negative Input	1,5	4	5,5	Vpp
BLANKING	Horizontal retrace/blanking time		11		μS
VIDEO	Frequency response (-3 db)		8		MHz
	Rise time		50		nS
	Over shoot		0,5	3	%
BEAM-LIMITER	Beam current		1		mA
CONTROLS	Brightness and contrast		100		%
Deflection					
GEOMETRY	Horizontal linearity		±14		%
	Vertical linearity		±10		%
	Pincushion		± 3		%
	Horizontal scan size		-4+10		%
	Vertical scan size		± 15		%
EHT					
EHT	(117 Vdc O-beam current)	23	24	25	KV
X-RAY SAFETY	EHT voltage which shut-off the Emission monitor		28,5		KV
X-RAY				←0,25	mR/h
CRT					
90°			19		INCHES

SETTING-UP PROCEDURE

INSTRUMENTATION REQUIRED

Digital multi-meter with input impedance of 10M Ω . An oscilloscope with a bandwidth of 10MHz and a 10/1 probe attenuator. An RGB color bar generator type HANTAREX K190E.

After the monitor has been turned on for about 5 minutes, adjust the controls until an acceptable image has been obtained and then proceed to the alignment of the chassis according to the following instructions.

1) POWER SUPPLY WITHOUT SIGNAL

Variable resistor RV 12 adjusts the supply voltage and requires adjustment only following repair, in which case proceed as follows:

- a) turn the G2 control counterclockwise to the minimum.
- b) connect digital voltmeter to SP20 and adjust RV12 to obtain a voltage of 115 Vdc

WARNING

Voltages greater than or less than nominal impair the functioning of the monitor.

2) RGB INPUT LEVELS. (signal: color bars)

Turn RV10, brightness control, to the maximum; checking on R27, R28, R31 adjust input control RV 1, 2, 3 (contrast) to obtain a 0,6 Vpp.

3) RGB VIDEO OUTPUT (signal: color bars)

- Adjust RV5; RV7; RV9 on the socket-board to obtain at KG; KR; KB, a "black level" at 140 Vdc.
- Adjust RV4; RV6; RV8 to have, at the same points, a "gain" of 50 Vpp.
- Adjust RV10 (brightness) to have, at the same points, a "black level" at 160 Vdc.
- Adjust G2 to obtain cut-off on the CRT.

4) WHITE BALANCE (signal: no signal)

With RV10 turned to make a white background visible correct the grey by means of RV5; RV7; RV9.

5) HORIZONTAL OSCILLATOR (signal: crosshatch)

Short circuit TP7 and TP8 then adjust RV13 to obtain the most stable image in the horizontal sense and then remove the short circuit.

6) VERTICAL OSCILLATOR (signal: crosshatch)

Regulate RV 15 so as to obtain a slight roll-over of the image in a downward direction. Then turn back slowly to stop this roll-over.

7) HORIZONTAL GEOMETRY (signal: crosshatch)

Set the horizontal linearity coil B4 for maximum amplitude and then adjust for the best horizontal linearity. Adjust RV14 for correct horizontal centering. Finally re-adjust horizontal amplitude by means of B5 width coil.

8) VERTICAL GEOMETRY (signal: crosshatch)

Adjust RV16 so as to reduce the image by 3 cm with respect to the height of the CRT. By means of RV23 centre the graticule vertically, and adjust RV16 again for the correct vertical amplitude and RV17 for the best linearity.

9) FOCUS (signal: crosshatch)

Adjust focus control to obtain the best visual result.

WARNING

The monitor is pre-set to work with a video active time of about 40 μ s. However, to change the video active time to 50 μ s cut the yellow jumper between points SP24; SP25 (see Diagram on page 10).

ADJUSTING TRIMMERS

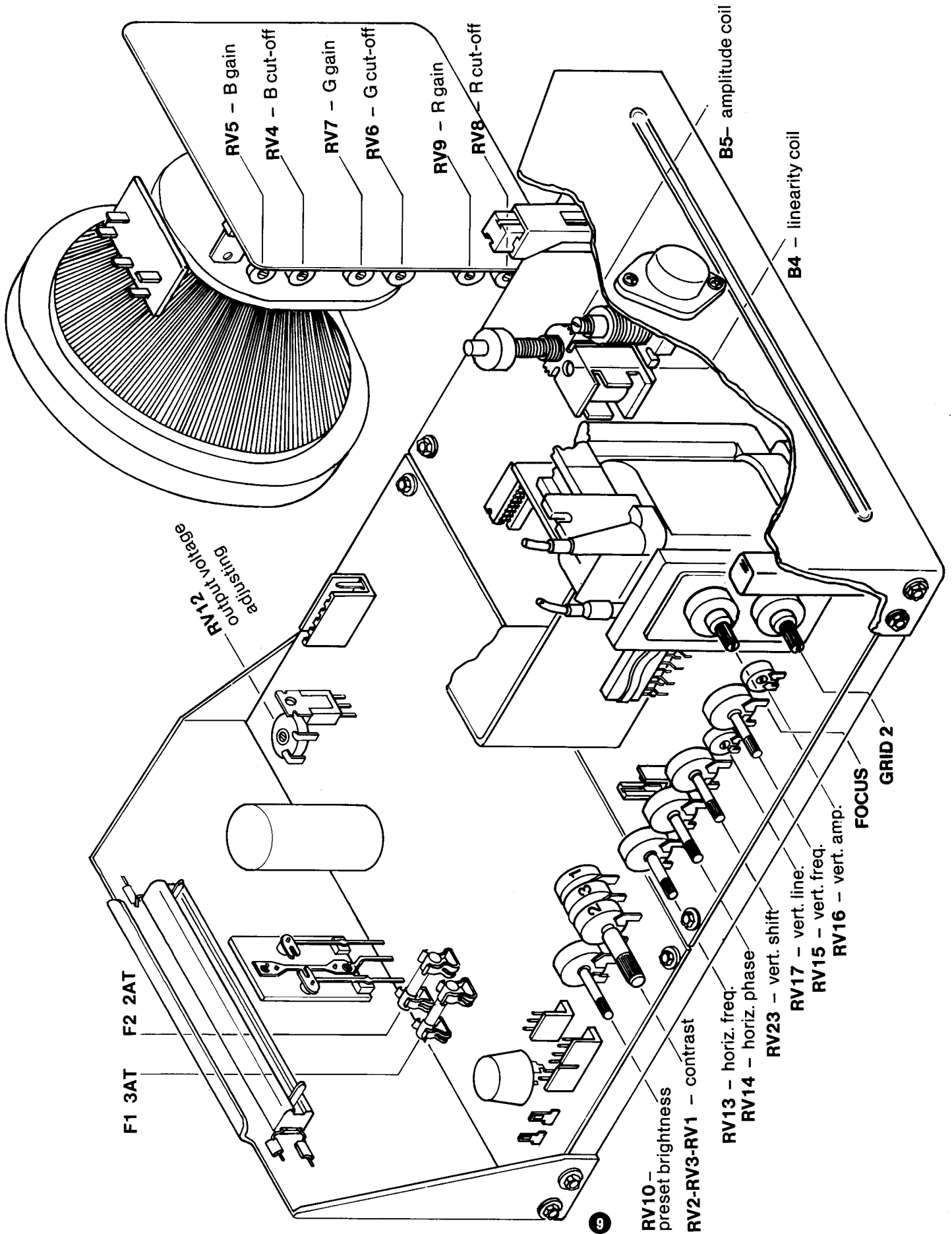

CONNECTION DIAGRAM

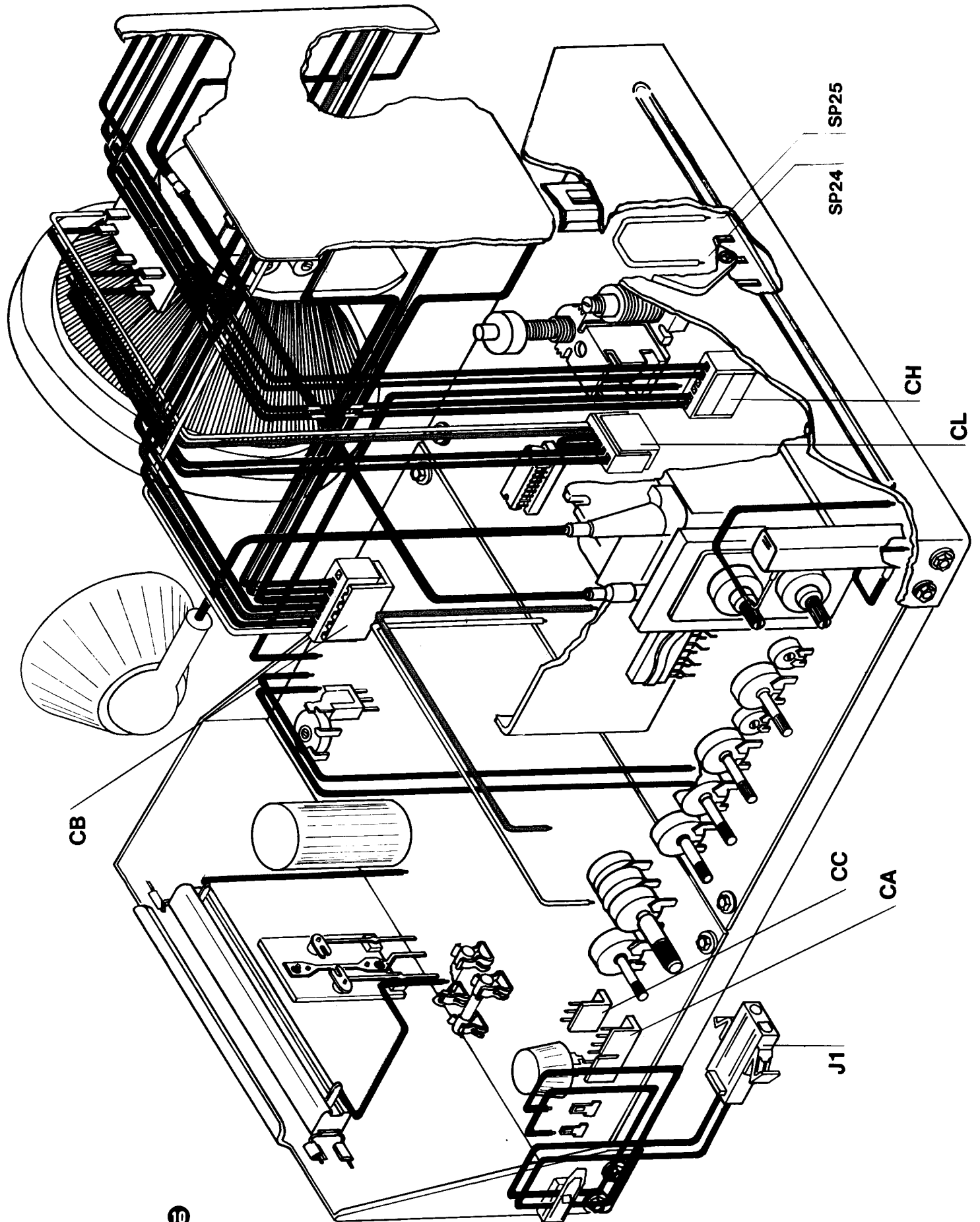

MECHANICAL DATA

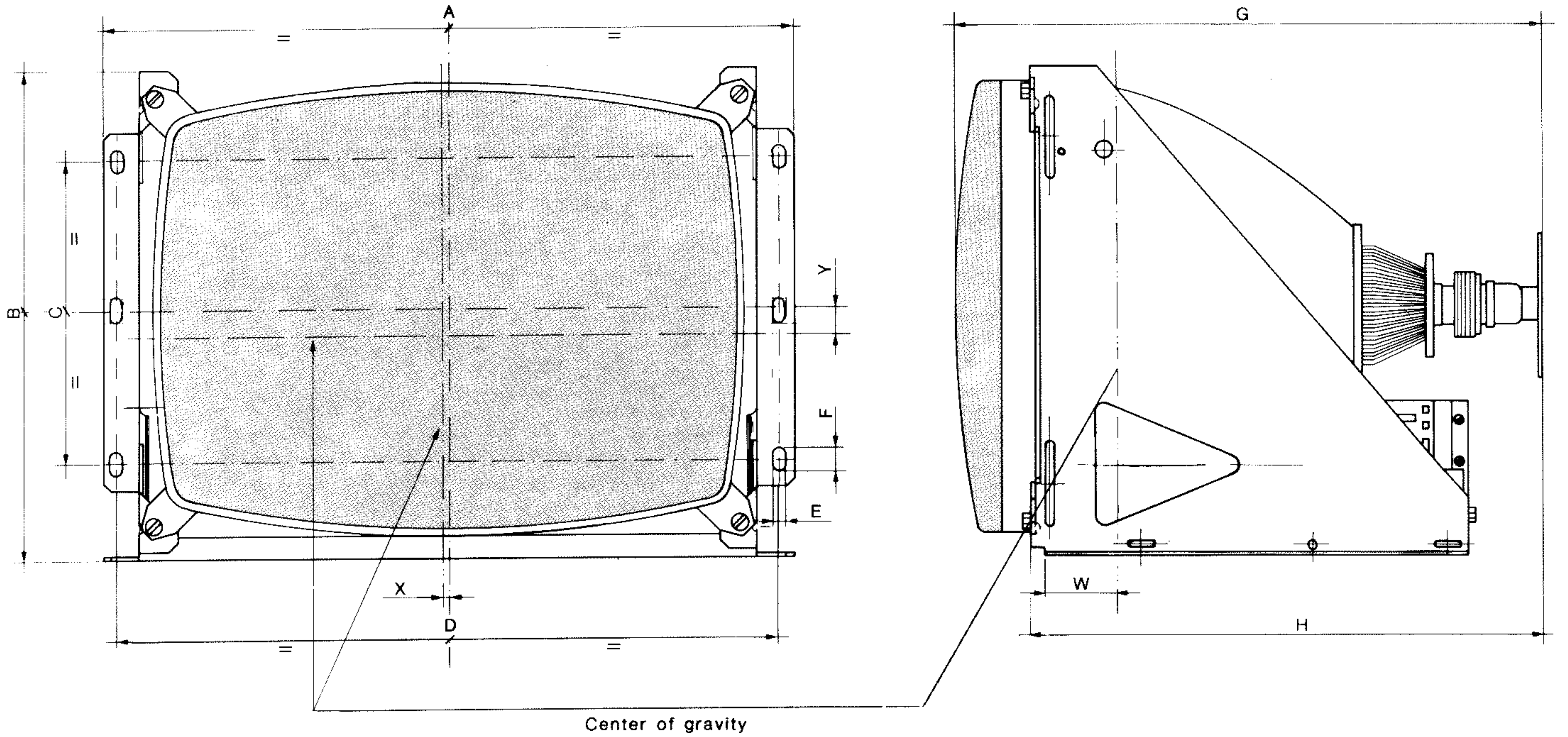

TYPE	A		B		C		D		E		F		G		H		X		Y		W	
	mm	inch.	mm	inch.	mm	inch.	mm	inch.	mm	inch.	mm	inch.	mm	inch.	mm	inch.	mm	inch.	mm	inch.	mm	inch.
19" 90°	518	20.39	364	14.33	228	8.97	498	19.60	8	0.315	16	0.6	427	16.81	355	13.97	5	0.197	22	0.866	55	2.165

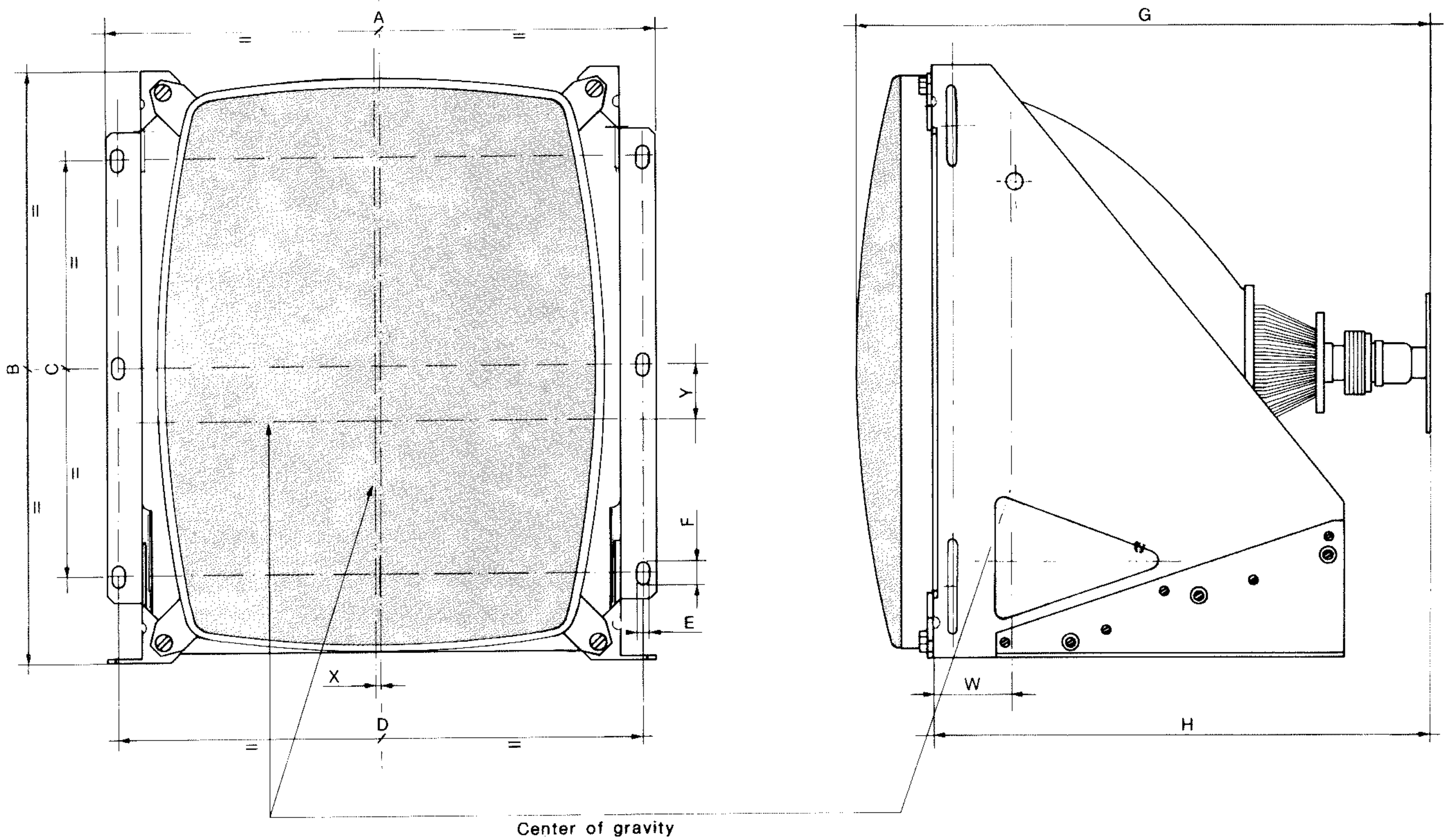

TYPE	A		B		C		D		E		F		G		H		X		Y		W	
	mm	inch.	mm	inch.	mm	inch.	mm	inch.	mm	inch.	mm	inch.	mm	inch.	mm	inch.	mm	inch.	mm	inch.	mm	inch.
19" 90°	425	16.73	463	18.22	327	12.24	445	17.51	8	0.315	16	0.6	427	16.81	355	13.97	5	0.197	42	1.653	60	2.362

HORIZONTAL COMBINATION I.C. PHILIPS TDA 2593

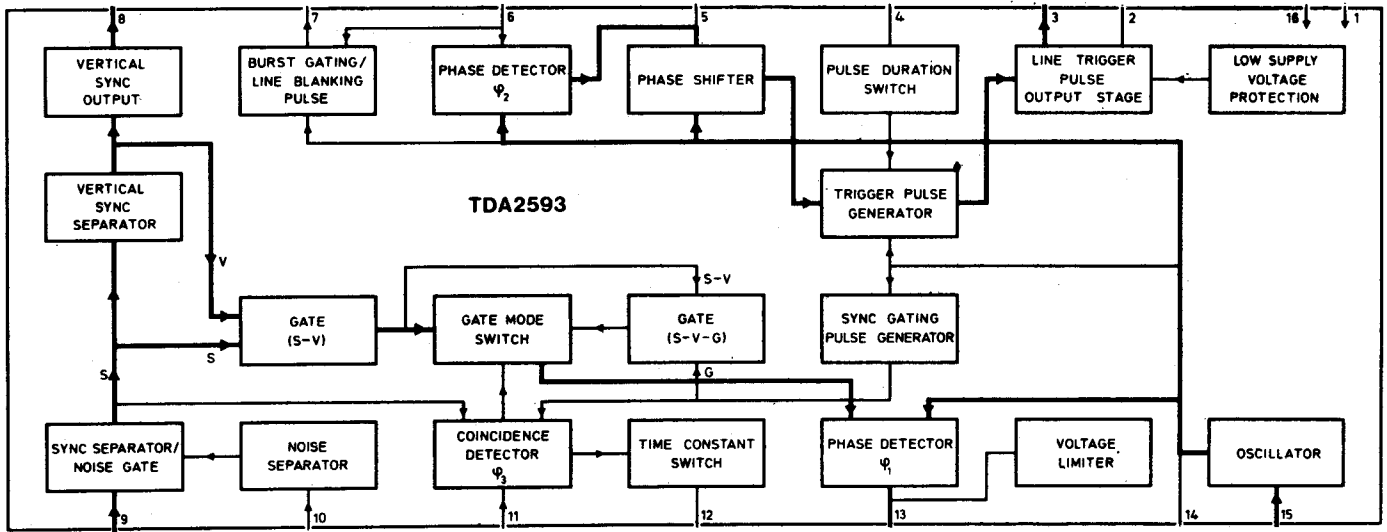

- PIN 1 = +11 Vdc
- PIN 2 = +11,2 Vdc
- PIN 3 = Picture 1
- PIN 4 = GND
- PIN 5 = +6,3 Vdc
- PIN 6 = Picture 2
- PIN 7 = Picture 3
- PIN 8 = NC
- PIN 9 = Picture 4
- PIN 10 = NC
- PIN 11 = +5 Vdc
- PIN 12 = +5,48 Vdc
- PIN 13 = +5,7 Vdc
- PIN 14 = Picture 5
- PIN 15 = +5,5 Vdc
- PIN 16 = GND

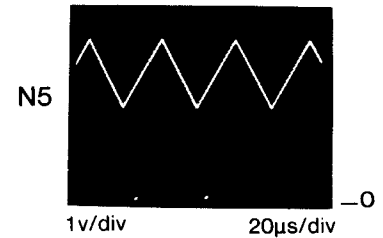
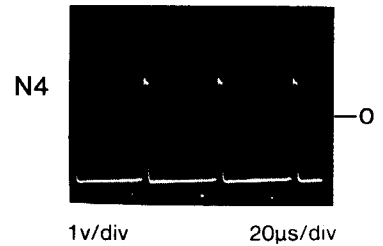
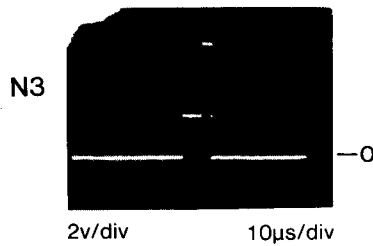
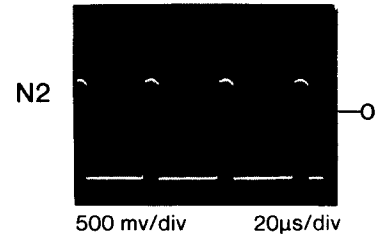
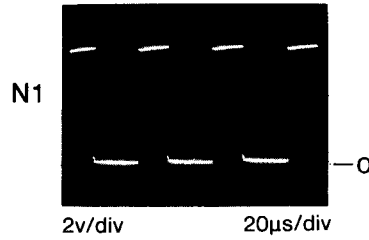

VERTICAL DEFLECTION CIRCUIT I.C. PHILIPS TDA 2653 A

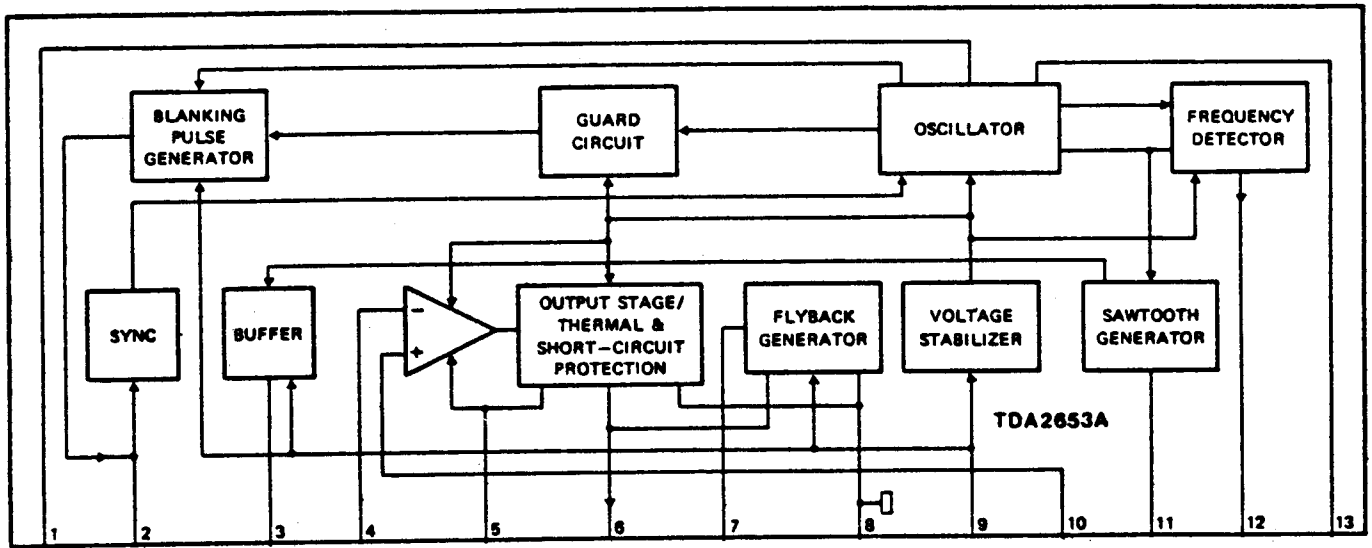

- PIN 1 = +7,24 Vdc
- PIN 2 = Picture 7
- PIN 3 = Picture 8
- PIN 4 = Picture 9
- PIN 5 = Picture 10
- PIN 6 = Picture 11
- PIN 7 = Picture 12
- PIN 8 = GND
- PIN 9 = +24,3 Vdc
- PIN 10 = 1,24 Vdc
- PIN 11 = Picture 13
- PIN 12 = NC
- PIN 13 = Picture 14

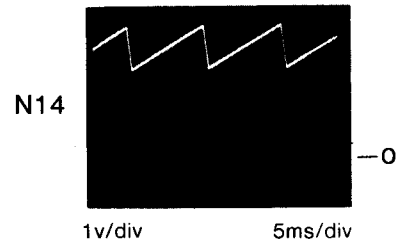
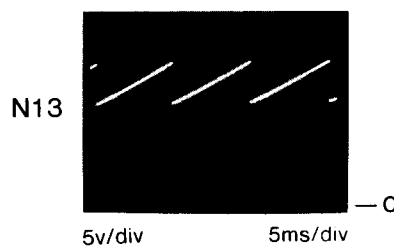
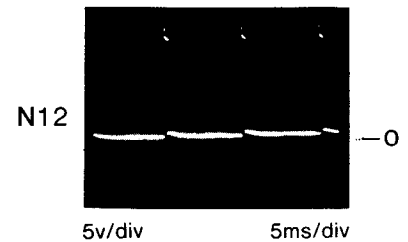
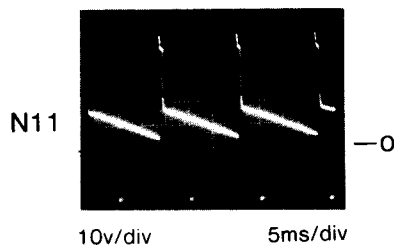
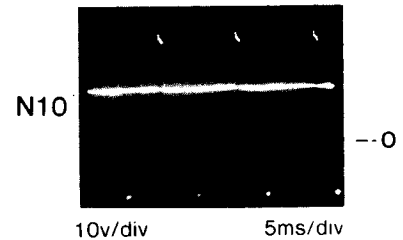
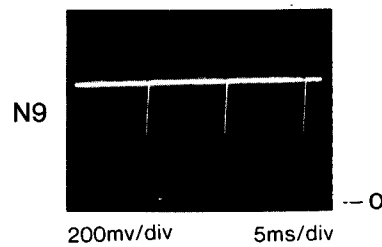
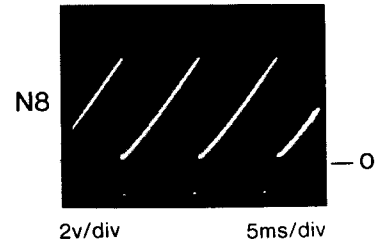
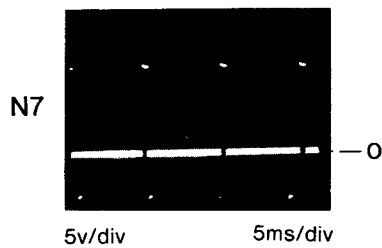

STATIC CONVERGENCE RINGS

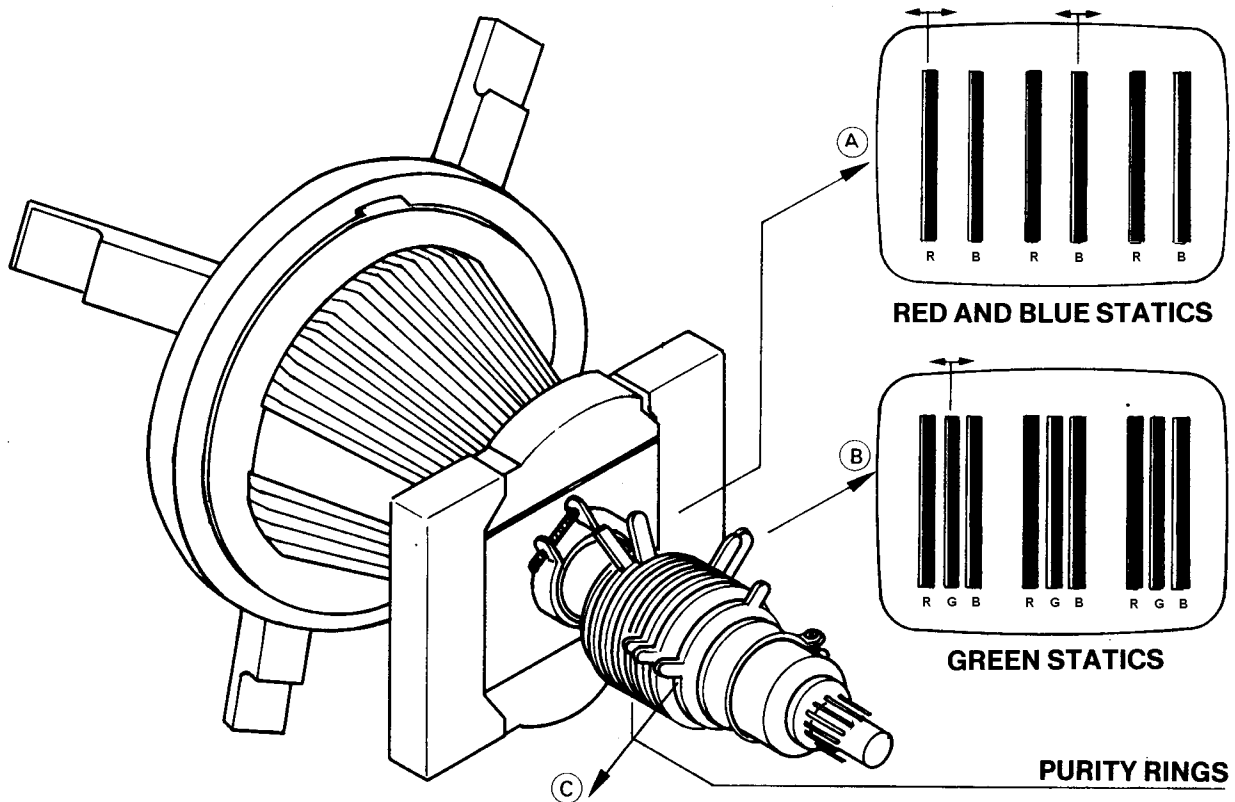

The kind of picture tube used, is the toshiba 510 510 UEB 22 (TC02) selfconvergence type. All Adjustments (purity and convergence) are directly made by the tube manufacturer.

In case convergence or purity readjustments are required, you can operate as follows using a crosshatch pattern generator:

Release the rings from the fixing resin taking care not to turn them.
The rings operate with the following sequency: (see the above picture)

- A These rings adjust convergency between red and blue.
- B These rings adjust convergency of green respect to red/blue
- C These rings adjust points out of purity using a generator with a red field.

Before operating, please take care that the monitor is free from residual magnetic fields. Should any part of the chassis or cabinet become magnetized, it will be necessary to de-gauss the affected area by means of a manual degaussing coil.

K 190E – COLOR GENERATOR

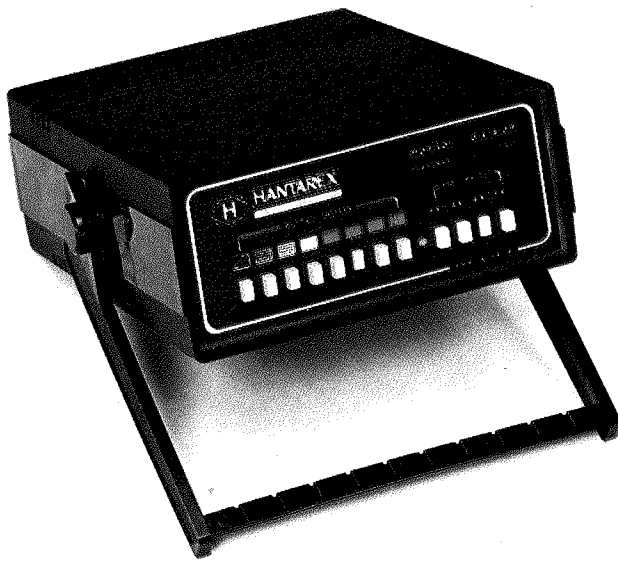

Test Signals and Controls:

- 1) 7-step grey bars from white to black: video ampl. linearity
- 2) dot: convergence
- 3) cross hatch: linearity and geometry
- 4) white field: picture tube chromatic temperature
- 5) blue/green/red/field: purity
- 6) white/yellow/orange/green purple/red/blue/black bars: RGB amplifiers video input levels.

Video Output Levels for all Signals

positive to 1V pp, 2Vpp, 4Vpp, 7Vpp (push button selection)

Synchronisms

horizontal and vertical, positive or negative: 5 μ s 4Vpp horizontal; 200 μ s 4Vpp vertical.

Mains Supply

120Vac – 15 + 10% 50/60 Hz

WAVEFORMS

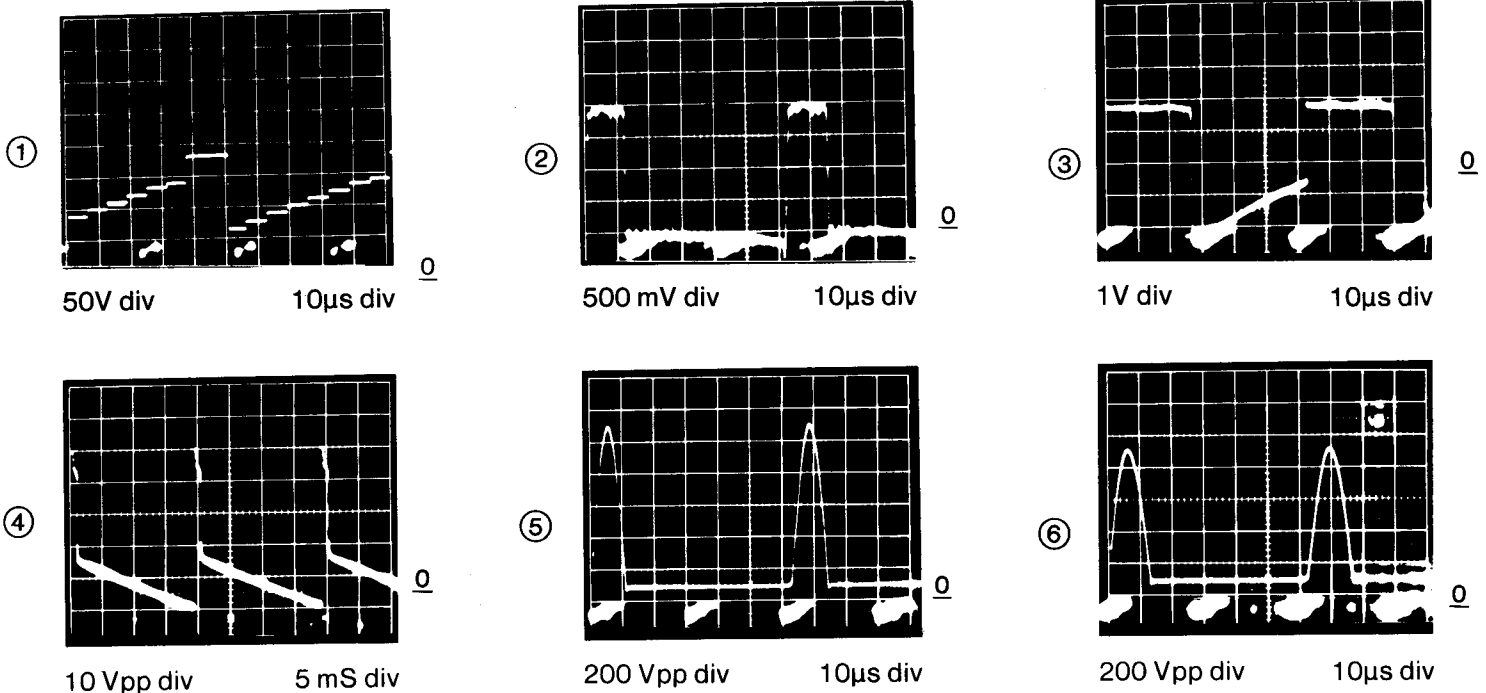

PRINTED CIRCUIT BOARD

DEFLECTION BOARD DE

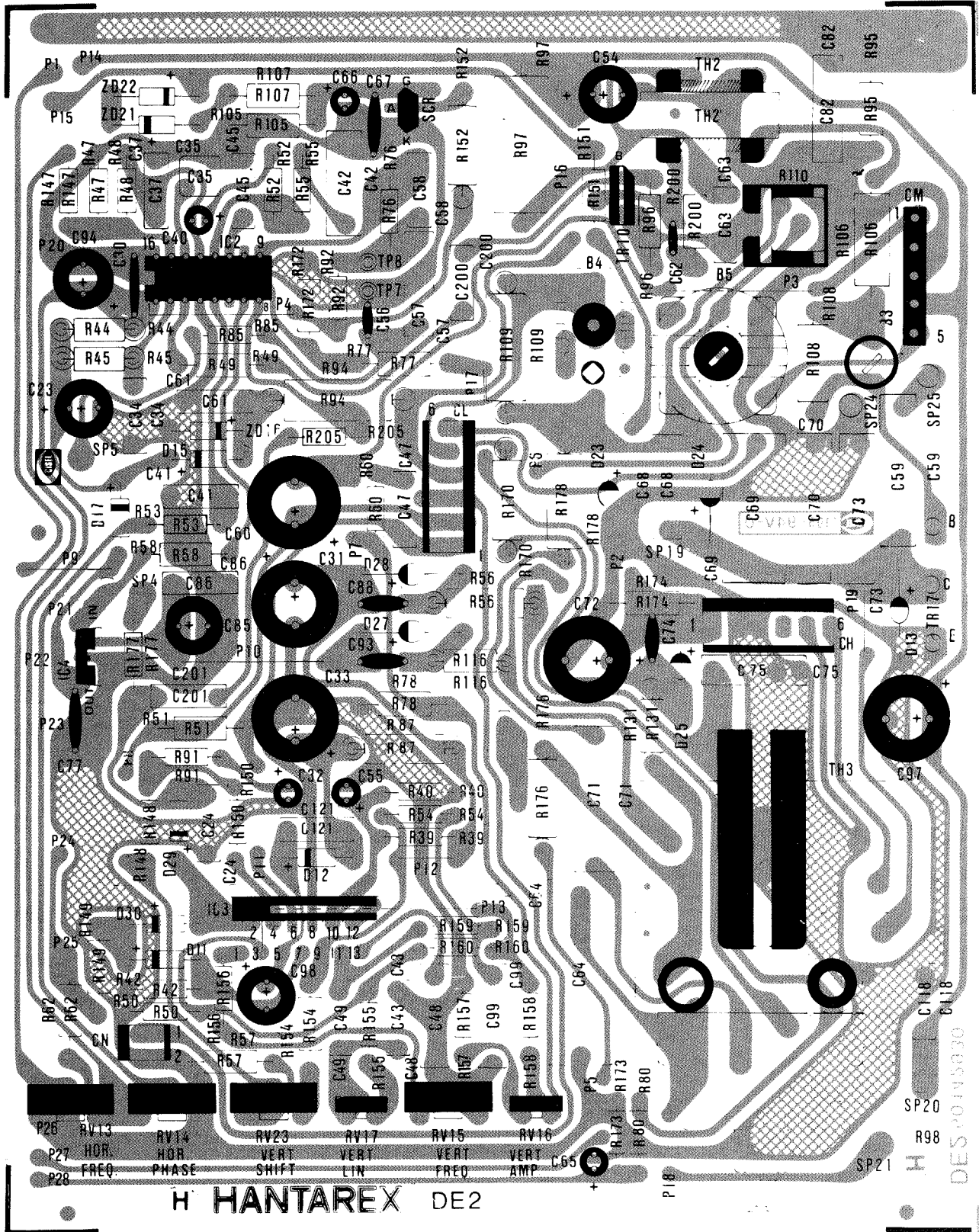

INTERFACE BOARD IE

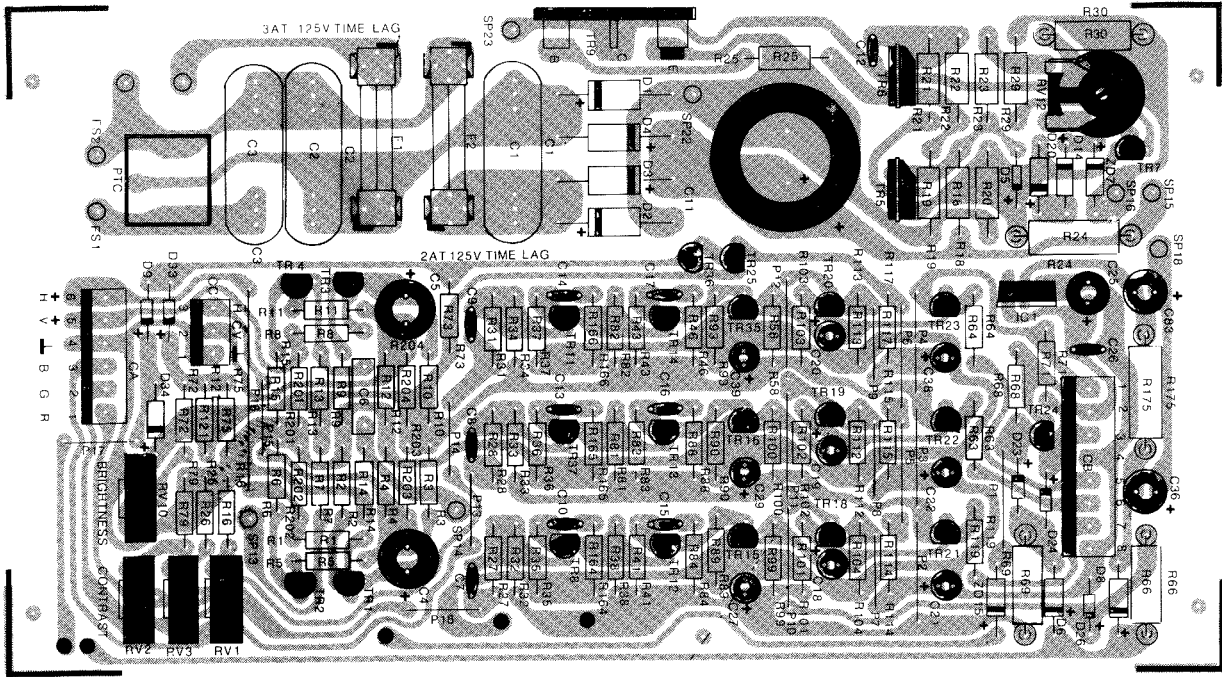

NECK BOARD NE

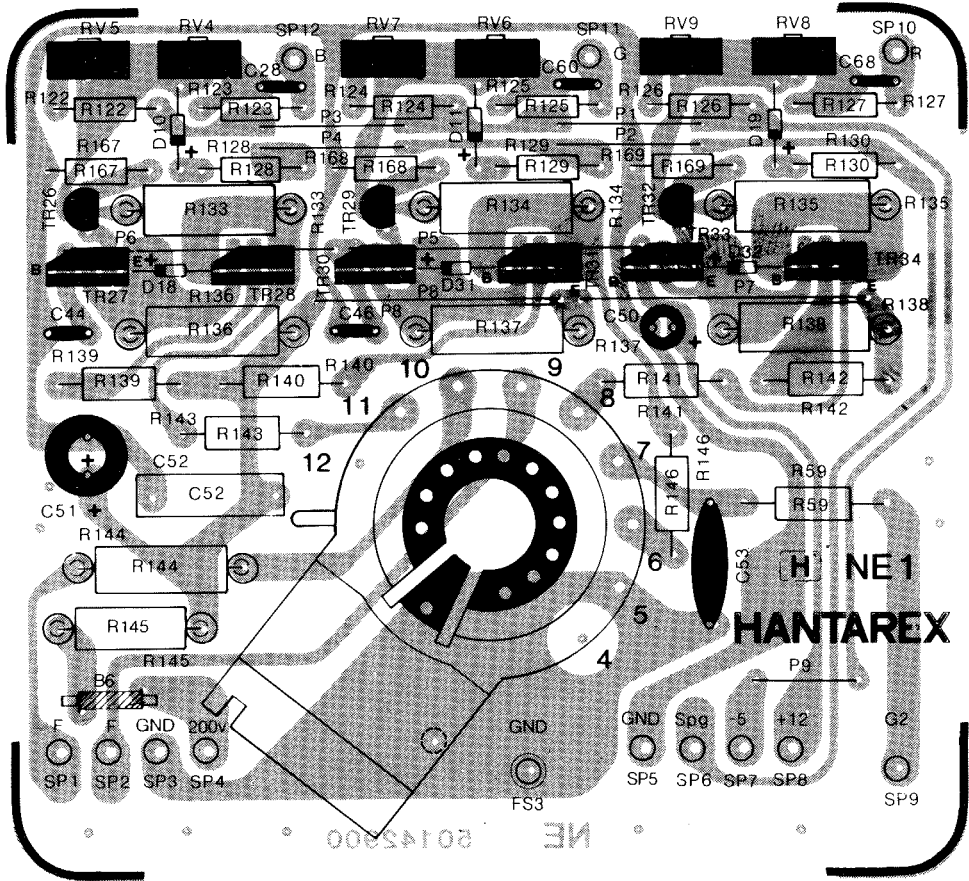

SCHEMATIC DIAGRAM

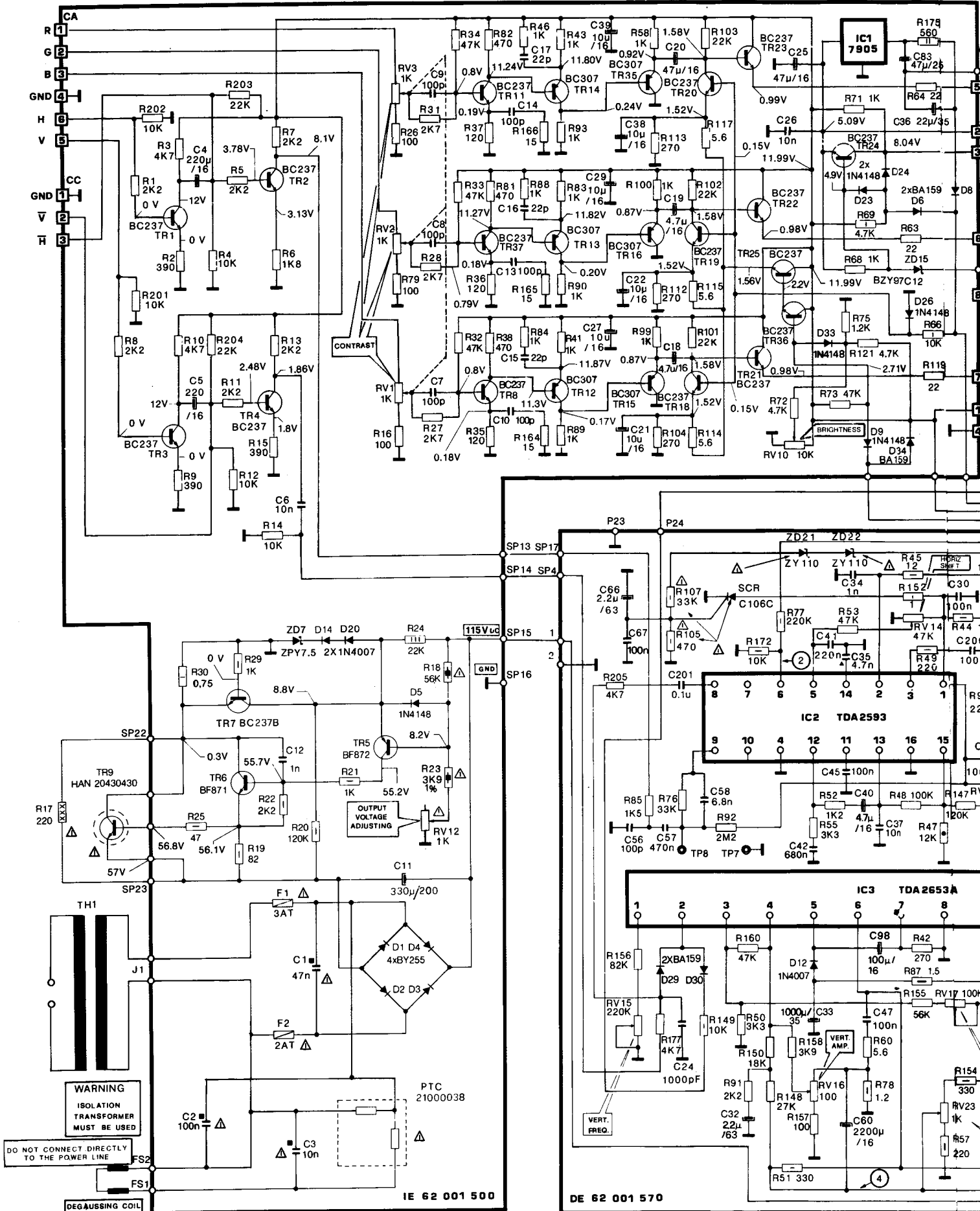

IE 62 001 500

DE 62 001 570

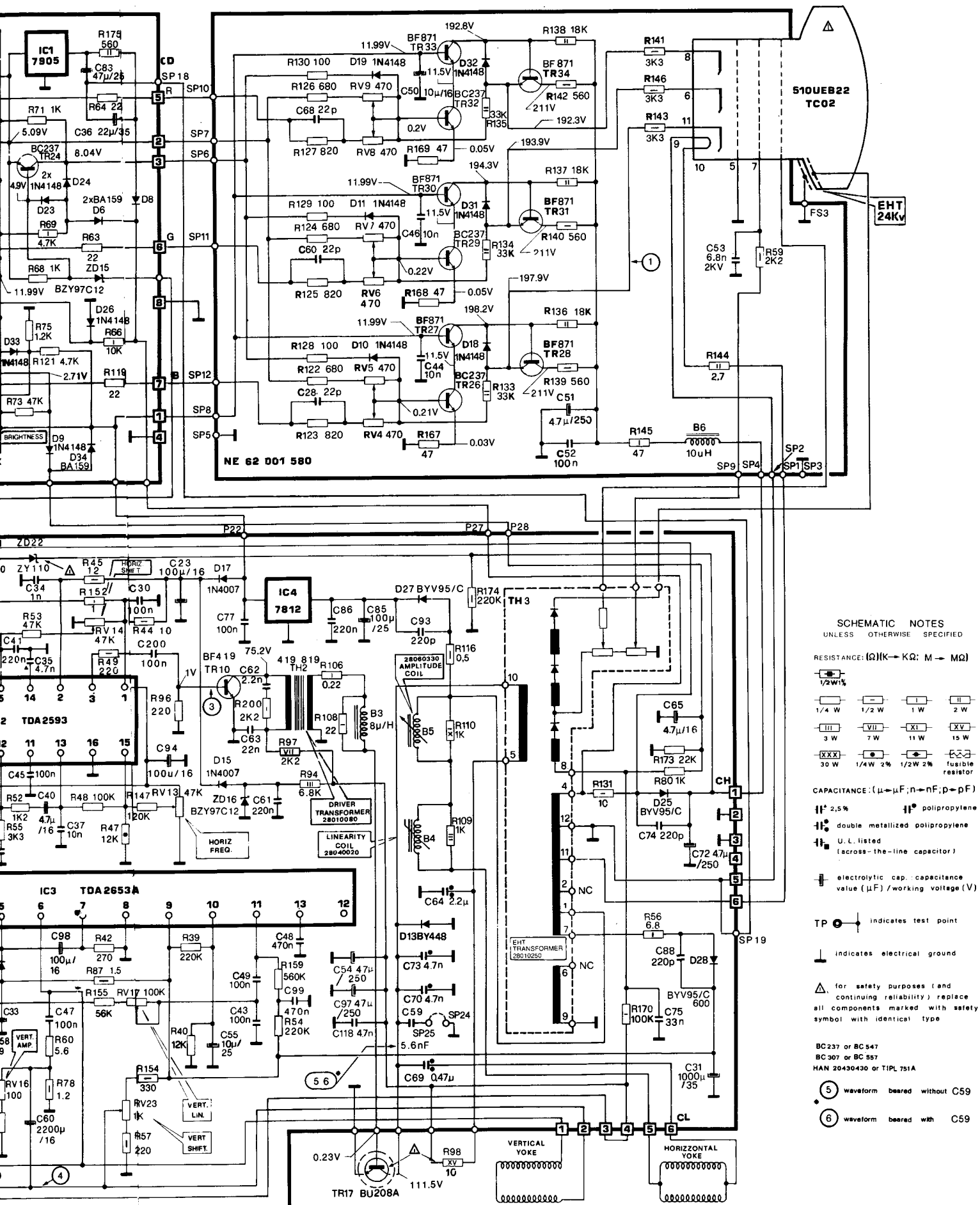

SCHEMATIC NOTES
UNLESS OTHERWISE SPECIFIED

RESISTANCE: (Ω)(K)→KΩ; M → MΩ

1/4 W 1/2 W 1 W 2 W
3 W 7 W 11 W 15 W
30 W 1/4 W 2% 1/2 W 2% fusible resistor

CAPACITANCE: (μ→μF; n→nF; p→pF)

±2.5% ± polipropylene
double metallized polipropylene
U.L. listed (across-the-line capacitor)
electrolytic cap. capacitance value (μF) / working voltage (V)

TP indicates test point

⊥ indicates electrical ground

⚠ for safety purposes (and continuing reliability) replace all components marked with safety symbol with identical type

BC237 or BC547
BC307 or BC557
HAN 20430430 or TIPL 751A

5 waveform beared without C59
6 waveform beared with C59

PARTS LIST

28040020	linearity coil	B 4	1
28060331	amp. coil	B 5	1
29300010	Ferric beads 8 mm		24
34020000	terminal PE 1120/D	TP 7-TP 8	2
34020090	socket for integrated circuit 16 pin		1
34023356	A.M.P. connector mod. 1-6D 28 0611/1		2
50142930	printed circuit deflection	DE	1

NE C.R.T. BASE code 62001580

CODE	DESCRIPTION	REF. NO.	QTY
20100000	diode 1N4148	D 10-D 11-D 18-D 19-D 31-D 32	6
20400420	trans. BC 237 B	TR 26-TR 29-TR 32	3
20420500	trans. BF 871	TR 27-TR 28-TR 30-TR 31-TR 33-TR 34	6
21231000	res. 1/4 W 5% 100 Ω	R 128-R 129-R 130	3
21236800	res. 1/4 W 5% 680 Ω	R 122-R 124-R 126	3
21238200	res. 1/4 W 5% 820 Ω	R 123-R 125-R 127	3
21224700	res. 1/4 W 5% 47 Ω	R 167-R 168-R 169	3
21335600	res. 1/2 W 5% 560 Ω	R 139-R 140-R 142	3
21342200	res. 1/2 W 5% 2.2 K	R 59	1
21343300	res. 1/2 W 5% 3.3 K	R 141-R 143-R 146	3
21424700	res. 1 W 5% 47 Ω	R 145	1
21512700	res. 2 W 5% 2,7 Ω Resista WK 5	R 144	1
21551800	res. 2 W 5% 18 K	R 136-R 137-R 138	3
21553300	metal oxid res. 2 W 5% 33 K	R 133-R 134-R 135	3
23034703	vertical trimmer PT 10 H 470 Ω	RV 4-RV 5-RV 6-RV 7-RV 8-RV 9	6
24321000	electrolytic capacitor EN 12.35 10 μF 16 V	C 50	1
24914700	electrolytic capacitor EN 12.35 4.7 μF 250 V	C 51	1
25461000	polyester capacitor 100 nF 10% 250 V 1.60	C 52	1
26222100	ceramic capacitor 22 pF 5% 50 V NPO	C 28-C 80-C 68	3
26468720	ceramic capacitor 6800 pF 20% 2000 V 507.6	C 53	1
26510601	ceramic capacitor 10000 pF -20+80 50 V	C 44-C 46	2
28020130	choke 10 μH with ferrite core	B 6	1
29300010	Ferric beads 8 mm		16
34020004	terminal AMP Faston M. 735084/2	FS3	1
54142900	socket printed circuit	NE	1

VERTICAL ALLUMINIUM HEAT SINK ASSEMBLY code 62001390

CODE	DESCRIPTION	REF. NO.	QTY
20620080	int. cct. MA 7812	IC 4	1
20620270	int. cct. TDA 2653 A	IC 3	1
40029065	self tapping screw 2,9x6,5 TCC		1
50111530	aluminium heat sink		1

POWER UNIT HEAT SINK ASSEMBLY code 62001510

CODE	DESCRIPTION	REF. NO.	QTY
18021500	wire U.L. 1007 AWG 22 brown	R 17-SP 22-SP 23	2
20430430	trans. HAN 20430430	TR 9	1
34020210	socket for TO 3 HAN		1
40029010	self tapping screw 2,9x10 TCC		1
40029014	self tapping screw 2,9x14 TCC		2
22932200	wire wound resistor 30 W 10% 220 Ω	R 17	1
50111040	heat sink 205 MO 32		1
50420120	mica insulator for TO 3 500 V		1

IE INTERFACE code 62001500

CODE	DESCRIPTION	REF. NO.	QTY.
18021030	wire U.L. 1007 AWG 22 orange 206 M 039	-	1
18021040	wire U.L. 1007 AWG 22 Black 206 M 040	-	1
18022500	wire U.L. 1007 AWG 22 red 206 M 051	-	1
18022510	wire U.L. 1007 AWG 22 Brown 206 M 050	-	1
20100000	diode 1N4148	D 5-9-23 D 24-26-33	6
20100010	diode BA 159	D 6-8-34	3
20110100	zener diode 1,3 W BZY 97 C 12	ZD 15	1
20110200	zener diode 1,3 WZY 7,5	ZD 7	1
20150007	diode 1 N 4007	D 14-D20	2
20150130	diode BY 255	TR 1-D 2-D 3-D 4	4
20400420	trans BC 237 B	TR 1-TR 2-TR 3-TR 4-TR 7-TR 8-TR 11-TR 18-TR 19-TR 20-TR 21-TR 36-TR 37-TR 22-TR 23-TR 24-TR 25 TR 12-TR 13-TR 14-TR 15-TR 16-TR 35	17
20400402	trans BC 307	TR 6	6
20420500	trans BF 871	TR 5	1
20420510	trans. BF 872	IC 1	1
20620071	integrated circuit MA 7905	PTC	1
21000038	dual PTC thermistor 2322.662.98013 110V	R 114-R 115-R 117	3
21215800	res. 1/4 W 5% 5,6 Ω	R 164-165-166	3
21221500	res. 1/4 W 5% 15 Ω	R 63-R 64-R 119	3
21222200	res. 1/4 W 5% 22 Ω	R 16-R 26-R 79	3
21231000	res. 1/4 W 5% 100 Ω	R 35-R 36-R 37	3
21231200	res. 1/4 W 5% 120 Ω	R 104-R 112-R 113	3
21232700	res. 1/4 W 5% 270 Ω	R 2-R 9-R 15	3
21233900	res. 1/4 W 5% 390 Ω	R 38-R 81-R 82	3
21234700	res. 1/4 W 5% 470 Ω	R 41-R 43-R 46-R 58-R 68-R 71-R 83-R 84-R 88-R 89-R 90-R 93-R 99-R 100	14
21241000	res. 1/4 W 5% 1 K	R 75	1
21241200	res. 1/4 W 5% 1,2 K	R 6	1
21241800	res. 1/4 W 5% 1,8 K	R 1-R 5-R 7-R 8-R 11-R 13	6
21242200	res. 1/4 W 5% 2,2 K	R 27-R 28-R 31 R 3-R 10-R 72-R 121 R 4-R 12-R 14-R 201-R 202	3
21242700	res. 1/4 W 5% 2,7 K	R 101-R 102-R 103-R 203-R 204	5
21244700	res. 1/4 W 5% 4,7 K	R 32-R 33-R 34-R 73	4
21251000	res. 1/4 W 5% 10K	R 25	1
21252200	res. 1/4 W 5% 22 K	R 19	1
21254700	res. 1/4 W 5% 47 K	R 21-R 29	2
213 24700	res. 1/2 W 5% 47 Ω	R 22	1
21328200	res. 1/2 W 5% 82 Ω	R 23	1
21341000	res. 1/2 W 5% 1 K	R 18	1
21342200	res. 1/2 W 5% 2,2 K	R 20	1
21343901	res. 1/2 W 1% 3,9 K	R 30	1
21356601	res. 1/2 W 1% 56 K	R 69	1
21361200	res. 1/2 W 5% 120 K	R 66	1
21407500	res. 1 W 5% 0,75 Ω	R 175	1
21444700	res. 1 W 5% 4,7 K	R 24	1
21451000	res. 1 W 5% 10 K	RV 1-RV 2-RV 3	3
21535600	metal oxid res. 2 W 5% 560 Ω	RV 12	1
21652200	res. 3 W 5% 22 K RESISTA WK 8	RV 10	1
23041000	vertical trimmer PT 15 NH 1 K	C 18-C 19-C 20	3
23041005	horizontal trimmer PT 15 V 1 K	C 21-C 22-C 27-C 29-C 38-C 39	6
23051004	vertical trimmer PT 15 NH 10 K	C 25	2
24314700	electrolytic capacitor EN 12,35 4,7 μ F 16 V	G 4-C 5	2
24321000	electrolytic capacitor EN 12,35 10 μ F 16 V	C 83	1
24324700	electrolytic capacitor EN 12,35 47 μ F 16 V	C 36	1
24332200	electrolytic capacitor EN 12,35 220 μ F 16 V	C 11	1
24424700	electrolytic capacitor EN 12,35 47 μ F 25 V	C 6	1
24522200	electrolytic capacitor EN 12,35 22 μ F 35 V	C 3	1
24933302	electrolytic capacitor 330 μ F 200 V	C 1	1
25651000	polyester capacitor 10 nF 10% 630 V 1.60 P 10	C 2	1
25751003	polyester capacitor 10 nF U.L. listed (across-the-line capacitor)	C 15-C16-C17	3
25754703	polyester capacitor 47 nF U.L. listed (across-the-line capacitor)	C 7-C 8-C 9-C 10-C 13-C 14	6
25761003	polyester capacitor 100 nF U.L. listed (across-the-line capacitor)	C 12	1
26222100	ceramic capacitor 22 pF 5% 50 V NPO	C 26	1
26310100	ceramic capacitor 100 pF 5% 50V NPO	F 2	4
26410803	ceramic capacitor 1000 pF 10% 50V	F 1	1
26510601	ceramic capacitor 10000 pF -20+80 50V	FS 1-FS 2	2
29100080	fuse holder for printed circuit	CB	1
29100200	fuse 2AT 6,3x32	CC	1
29100210	fuse 3AT 6,3x32	CA	1
29300010	ferric beads 8 mm.	IE 2	1
34020004	faston terminal		1
34023358	AMP connector 8 D 280612/1		1
34025103	MOLEX connector 3190-03		1
34025106	MOLEX connector 3190-06		1
50142911	Printed circuit interface		1

DE DEFLECTION code 62001590

CODE	DESCRIPTION	REF. NO.	QTY.
20100010	diode BA 159	D 29-D 30	2
20110100	zener diode 1,3 W BZY 97 C 12	ZD 16	1
20110500	zener diode 1,3 WZY 110	ZD 22-ZD 21	2
20150007	diode 1N 4007	D 12-D 15-D 17	3
20150170	diode BYV 95/C-600	D 25-D 27-D 28	3
20150200	diode BY 448	D 13	1
20420140	trans. BF 419	TR 10	1
20440000	thyristor C 106 C	SCR	1
20620190	integrated circuit TDA 2593	IC 2	1
21215600	res. 1/4 W 5% 5,6 Ω	R 60	1
21231000	res. 1/4 W 5% 100 Ω	R 157	1
21232700	res. 1/4 W 5% 270 Ω	R 42	1
21241000	res. 1/4 W 5% 1 K	R 80	1
21241200	res. 1/4 W 5% 1,2 K	R 52	1
21241500	res. 1/4 W 5% 1,5 K	R 85	1
21242200	res. 1/4 W 5% 2,2 K	R 91	1
21243300	res. 1/4 W 5% 3,3 K	R 50-R 55	2
21243900	res. 1/4 W 5% 3,9 K	R 158	1
21244700	res. 1/4 W 5% 4,7 K	R 205-R 177	2
21351000	res. 1/2 W 5% 10 K	R 172-R 149	2
21251200	res. 1/4 W 5% 12 K	R 40	1
21251202	metal film resistor 1/4 W 1% 12 K PH MR 25	R 47	1
21251800	res. 1/4 W 5% 18 K	R 150	1
21252200	res. 1/4 W 5% 22 K	R 173	1
21252700	res. 1/4 W 5% 27 K	R 53-R 148	2
21253300	res. 1/4 W 5% 33 K	R 76	1
21254700	res. 1/4 W 5% 47 K	R 180	1
21255600	res. 1/4 W 5% 56 K	R 155	1
21258200	res. 1/4 W 5% 82 K	R 156	1
21261000	res. 1/4 W 5% 100 K	R 48	1
21261200	res. 1/4 W 5% 120 K	R 147	1
21262200	res. 1/4 W 5% 220 K	R 39-R 54	2
21265600	res. 1/4 W 5% 560 K	R 159	1
21272200	res. 1/4 W 5% 2,2 M	R 92	1
21305000	res. 1/2 W 5% 0,5 Ω	R 116	1
21311201	metal film resistor 1/2 W 2% 1,2 Ω PHVR 37	R 78	1
21311500	res. 1/2 W 5% 1,5 Ω	R 87	1
21321000	res. 1/2 W 5% 10 Ω	R44-R 131	2
21321200	res. 1/2 W 5% 12 Ω	R 45	1
21332200	res. 1/2 W 5% 220 Ω	R 49-R 57-R 96	3
21333300	res. 1/2 W 5% 330 Ω	R 51-R 154	2
21334700	res. 1/2 W 5% 470 Ω	R 105	1
21342200	res. 1/2 W 2,2 K 5%	R 200	1
21353300	res. 1/2 W 5% 33 K	R 107	1
21362200	res. 1/2 W 5% 220 K	R 77-R 174	2
21402200	res. 1 W 10% 0,22 Ω VTM 200-0	R 106	1
21411000	res. 1 W 5% 1 Ω WK4	R 152	1
21416800	res. 1 W 5% 6,8 Ω	R 56	1
21422200	res. 1 W 5% 22 Ω	R 108	1
21461000	res. 1 W 5% 100 K	R 170	1
21641000	res. 3 W 5% 1 K	R 109	1
21746800	metal oxide res. 4 W 5% 6,8 K	R 94	1
22541000	res. 11 W 5% 1 K	R 110	1
22342200	res. 7 W 5% 2,2 K	R 97	1
23031000	trimmer PT 10 H 100 Ω	RV 16	1
23041000	vertical trimmer PT 15 NH 1 K	RV 23	1
23054703	vertical trimmer PT 15 NH 47 K	RV 13-RV 14	2
23061002	vertical trimmer PT 10 NH 100 K	RV 17	1
23062201	vertical trimmer PT 15 NH 220 K	RV 15	1
24314700	electrolytic capacitor EN 12,35 4,7 μ F 16 V	C 40-C 65	2
24331000	electrolytic capacitor EN 12,35 100 μ F 16 V	C 23-C 94-C 98	3
24342200	electrolytic capacitor EN 12,35 2200 μ F 16 V	C 60	1
24421000	electrolytic capacitor EN 12,35 10 μ F 25 V	C 55	1
24431000	electrolytic capacitor EN 12,35 100 μ F 25 V	C 85	1
24541000	electrolytic capacitor EN 12,35 1000 μ F 35 V	C 31-C 33	2
24612200	electrolytic capacitor EN 12,35 2,2 μ F 63 V	C 32-C 66	2
24914700	electrolytic capacitor EN 12,35 4,7 μ F 250 V	C 54	1
24924702	electrolytic capacitor EN 12,35 47 μ F 250 V	C 72-C 97	2
25144701	polyester capacitor 4,7 nF 2,5% 63 V 1,42	C 35	1
25262200	polyester capacitor 220 nF 10% 100 V 1,60	C 41-C 61-C 86	3
25264700	polyester capacitor 470 nF 10% 100 V 1,60	C 48-C 57-C 99	3
25266800	polyester capacitor 680 nF 10% 100 V 1,60	C 42	1
25361001	polyester capacitor 100 nF 10% 160 V 1,60	C 45-C 200-C 201	3
25441000	polyester capacitor 1 nF 250 V 1,60	C 24	1
25444700	polyester capacitor 4,7 nF 10% 250 V 1,60	C 118	1
25451000	polyester capacitor 10 nF 10% 250V 1,60	C 37	1
25452200	polyester capacitor 22 nF 10% 250 V 1,60	C 63	1
25461010	polyester capacitor 100 nF 250 V 1,60	C 43-C 47-C 49	3
25464710	polyester capacitor 470 nF 10% 250 V 1,76	C 69	1
25472200	polyester capacitor 2,2 μ F 10% 250 V 1,60	C 64	1
25653301	polyester capacitor 33 nF 10% 630 V 1,60	C 75	1
25646800	polyester capacitor 6,8 nF 10% 630 V 1,60	C 58	1
25741000	polyester capacitor 1 nF 10% 1000 V 1,60	C 34	1
2594560	polyester capacitor 5,6 nF 10% 2000 V 1,73	C 59	1
25944700	polyester capacitor 4,7 nF 5% 1750 V 1,73	C 70-C 73	1
26310100	ceramic capacitor 100 pF 5% 50 V NPO	C 56	1
26322400	ceramic capacitor 220 pF 10% 1000 V	C 74-C 88-C 93	3
26422608	ceramic capacitor 2200 pF -20-50 500 V	C 62	1
26610601	ceramic capacitor 100000 pF -20+80 50 V	C 30-C 67-C 77	3
28010080	driver transformer	TH 2	1
28010250	transf. diode split HIT. 2433011	TH 3	1
28020200	choke 8 μ H with ferrite core	B 3	1



HANTAREX U.S.A. LTD.

127 Prospect Avenue
DOUGLASTON-New York 11363
tel. (212) 423-2672/423-2915
telex 7105822453