

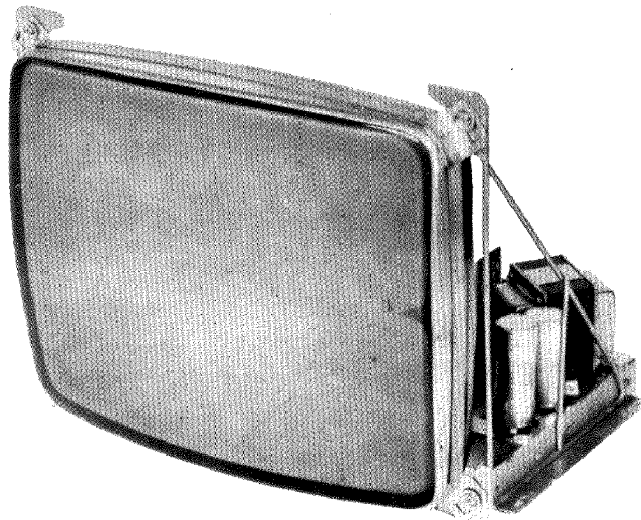

SERVICE MANUAL

TV Monitor

MODEL TM-600 TM-623



GENERAL

TM-600 and TM-623 is a Television Monitor for video game. Designed for operation either from a main supply of 115 Volts/50-60 Hz AC or 230 Volts/50-60 Hz AC.

The complete monitor incorporates 1 Picture tube, 1 Integrated circuit, 20 Silicon Transistors, 18 Silicon diodes, 2 Germanium diodes, 1 High Voltage Selenium diode.

This model is equipped with 5V/3A power supply for the operation of TTL control board and operation double pulse type AFC circuit to obtain stable picture.

TEC VIDEOELECTRONICS INC

SPECIFICATIONS

POWER SUPPLY INPUT

115 Volts/230 volts 50-60 Hz $\pm 10\%$

POWER CONSUMPTION

60 Watts

VIDEO INPUT

0.5 Volts composite P/P for 100 Volts

2.5 Volts P/P maximum.

Sync negative at input.

PICTURE TUBE

19" (500 mm), 114° deflection.

23" (584.20mm), 110° deflection.

Integral implosion Protection.

HIGH VOLTAGE

18 KV nominal at 0 Microamperes
beam current.

HORIZONTAL RETRACE TIME

12 microseconds maximum.

RESOLUTION

500 Lines minimum at picture center.

SCANNING FREQUENCY

Horizontal 15.750 Hz ± 500 Hz

Vertical 50-60 Hz

tone BURST AMPLIFIER

5 Watts peak output with TTL drive
at nominal line, fully adjustable

4 Watts peak output at low line.

ENVIRONMENT

Operation : Maximum ambient temperature
50°C (122°F)

Storage : Temperature range from -40°C
to +65°C

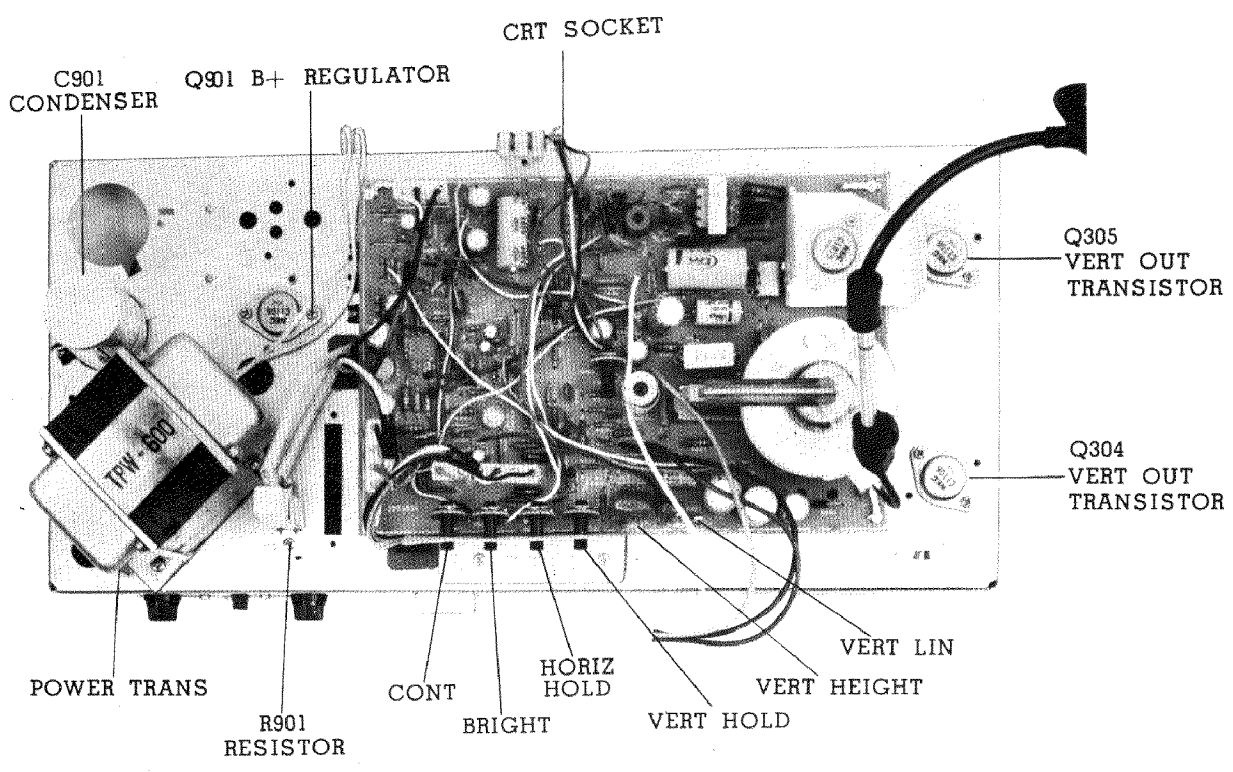
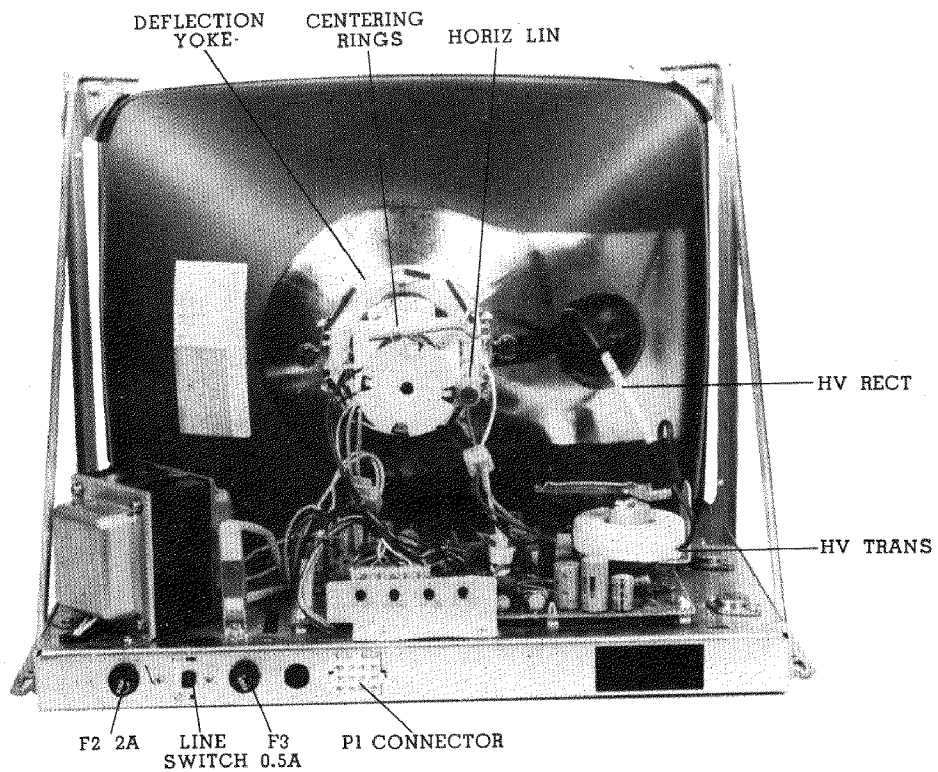

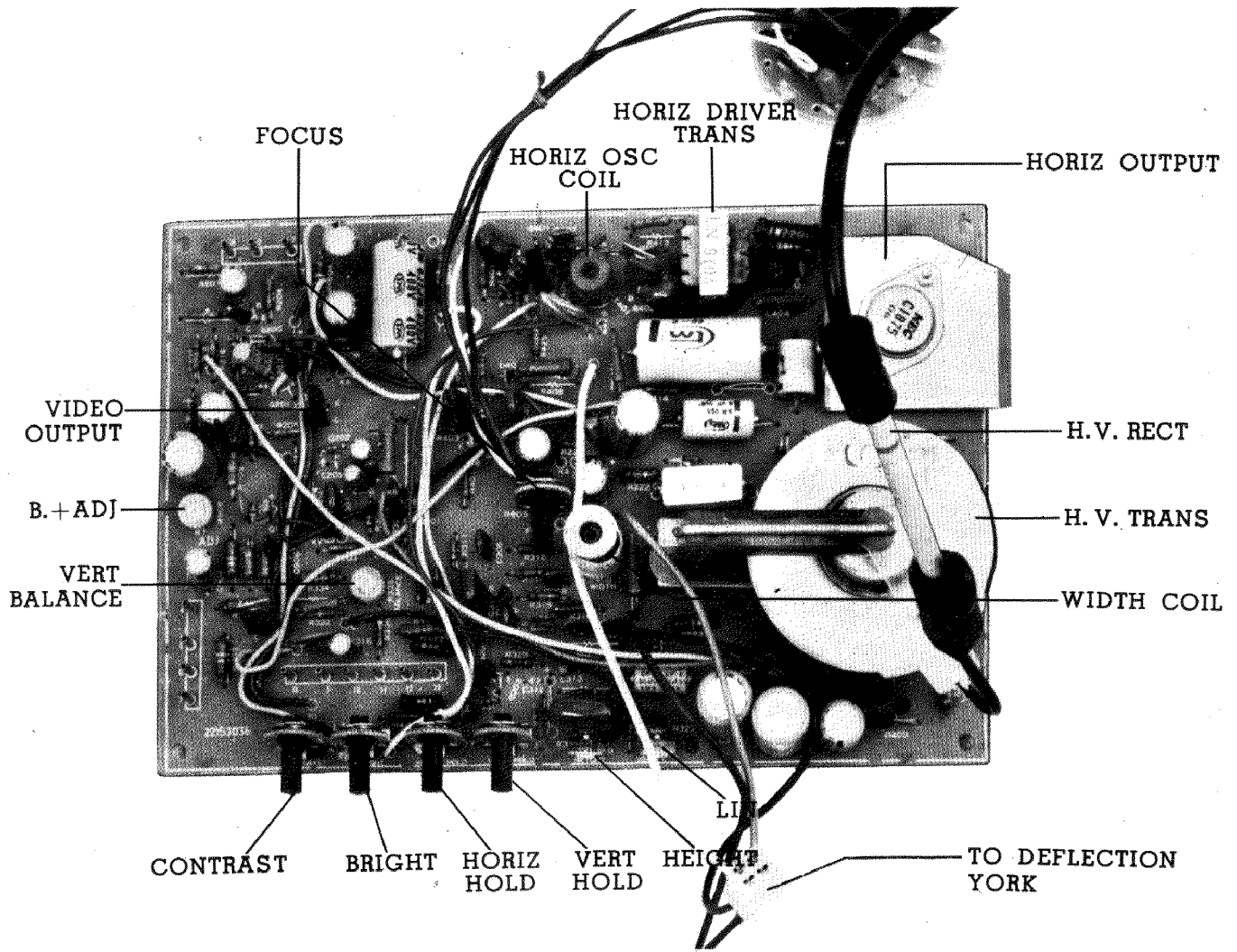

REPLACEMENT PARTS LIST

SAFETY CRITICAL COMPONENTS NOTE

FOR CONTINUED SAFETY REPLACE THOSE COMPONENTS INDICATED BY SHADING WITH EXACT REPLACEMENT PARTS ONLY. REFER "SAFETY CRITICAL COMPONENTS" OF SERVICE MANUAL'S REPLACEMENT PARTS LIST.

REF NO PART NO DESCRIPTION

ELECTRICAL PARTS

PCB1 2215303600 MAIN PCB
A 801 485TM60003 CRT PCB

TRANSISTOR AND IC

Q 200 5310500202 MPS9700T 1st VIDEO AMP
or MPS834
Q 201 5310500261 MPS9750T 2nd VIDEO AMP
or MPS4356
Q 202 5310500410 2N6558 VIDEO OUTPUT
or MPSU-10
Q 301 5310500261 MPS9750T SYNC SEPERATOR
or MPS4356
Q 302 5310500201 MPS9700U VERT OSC
or MPS834
Q 303 5300500201 MPS9700U VERT AMP
or MPS834
Q 304 4310400030 2SC1106 VERT OUTPUT
Q 305 or 2N6307
Q 400 5310500202 MPS9700T PHASE INV
or MPS834
Q 401 5310500202 MPS9700T HORIZ OSC
or MPS834
Q 402 5310500410 2N6558 HORIZ AMP
or MJE9742
or 2N4354
Q 403 5310400040 2SC1875 HORIZ OUTPUT
or MJ205
* Q 901 5310400030 2SC1106 POWER REGULATOR
or MJ3430
Q 902 5310500410 2N6558 REGULATOR AMP
or 5310500070 MPS-U04
Q 903 5310500280 LM1796 REFERENCE AMP
or MPS-D01

CRT AND DIODE

* V 801 5380000060 500 SB4 CRT
D 203 5340200280 MR9712 SILICON DIODE
or IN4004 L.V. RECTIFIER
D 204 5340200430 IN4148 SILICON DIODE
or IN4002 BLANKIG CLIP
D 205 5340200430 IN4148 SILICON DIODE
or IN4002 BLANKIG CLIP

D 206 5340200430 IN4148 SILICON DIODE
or IN4002 BLANKIG CLIP

REF NO PART NO DESCRIPTION

D 207 534020280 MR9712 200V RECT
or IN4004
D208 5340200430 IN4148 SILICON DIODE
D 301 5340200260 MR-9701 RECTIFIER
or IN4148 SILICON DIODE
D 401 5340100040 AA143 PHASE DET
or IN60
D 402 5340100040 AA143 PHASE DET
or IN60
D 403 5340200300 MR9722 DAMPER
or IN4148
* D 404 5340400120 TV20-2K80J H.V. RECTIFER
or HS30/lb
D 801 5340200290 MR9713 400V RECT
or IN4006
D 901 5340200270 MR9/04 RECTIFIER
or IN4005 SILICON DIODE
D 902 5340200270 MR9704 RECTIFIER
or IN4005 SILICON DIODE
D 903 5340200270 MR9704 RECTIFIER
or IN4005 SILICON DIODE
D 904 5340200270 MR9704 RECTIFIER
or IN4005 SILICON DIODE
D 906 5340300220 1N5858A ZENER DIODE
or 5340300310 IN6002A

COILS AND TRANS

* L 401 589515015 TDY1005 D.Y. COIL
L 402 589512015 HCH1005 HORIZ CHOCK COIL
L 403 589512012 HC2-035 CHOKE COIL
L 404 589512012 HC2-035 CHOKE COIL
L 405 589514013 AZ-9177 DM WIDTH COIL
L 406 589514016 LH-15J54 LIN COIL
T 401 589514015 TLN-506 BX HORIZ OSC
T 402 589518012 TLN-519 HORIZ DRIVE
* T 403 589517017 TFB-1006 AS F.B.T
* T 901 589519021 TPW-600 POWER TRANS
TPW-623

RESISTORS

R 201 RD-4L471J 470 ohm J $\frac{1}{4}$ W
R 202 RD-4L223J 22 K ohm J $\frac{1}{4}$ W
R 203 RD-4L563J 56 K ohm J $\frac{1}{4}$ W
R 204 RD-4L471J 470 ohm J $\frac{1}{4}$ W
R 207 RD-4L560J 56 ohm J $\frac{1}{4}$ W

REPLACEMENT PARTS LIST

R 208	RD-4L102J-	1 K ohm J	$\frac{1}{4}$ W	R 412	RD-4L 561J	560 ohm J	$\frac{1}{4}$ W
R 210	RS-029562J	5.6K ohm J	2 W	R 413	RS01P682J	6.8 K ohm J	1 W
R 215	RD-42101J	1 K ohm J	$\frac{1}{4}$ W	R 414	RD-2L 221J	220 ohm J	$\frac{1}{2}$ W
* R 216	RD-4L101J	100 ohm J	$\frac{1}{4}$ W	R 415	5160122903	2.2 ohm J	1 W
* R 217	RD-4L470J	47 ohm J	$\frac{1}{2}$ W				

REF NO PART NO DESCRIPTION

R 218	RD-4L223J	22 K ohm J	$\frac{1}{4}$ W
R 219	RD-4L563J	56 K ohm J	$\frac{1}{4}$ W
R 220	RD-4L102J	1 K ohm J	$\frac{1}{4}$ W
R 221	RD-4L102J	1 K ohm J	$\frac{1}{4}$ W
R 222	RD-2L102J	1 K ohm J	$\frac{1}{2}$ W
R 223	RD-2L102J	1 K ohm J	$\frac{1}{2}$ W
R 224	RD-2L122J	1.2 K ohm J	$\frac{1}{2}$ W
* R 226	RS01P101J	100 ohm J	1 W
R 227	RD-2L123J	12 K ohm J	$\frac{1}{2}$ W
R 228	RD-2L105J	1.5 K ohm J	$\frac{1}{2}$ W
R 229	RD-4M681J	680 ohm J	$\frac{1}{4}$ W
R 302	RD-4M331J	330 ohm J	$\frac{1}{4}$ W
R 303	RD-4L562J-	5.6 K ohm J	$\frac{1}{4}$ W
R 304	RD-4M102J	1 K ohm J	$\frac{1}{4}$ W
R 308	RD-4M104J	100K ohm J	$\frac{1}{4}$ W
R 309	RD-4M155T	1.5 Mohm J	$\frac{1}{4}$ W
R 310	RD-4M332J	3.3 K ohm J	$\frac{1}{4}$ W
R 311	RD-4M563J	56 K ohm J	$\frac{1}{4}$ W
R 312	RD-4L 182J	1.8 K ohm J	$\frac{1}{4}$ W
R 313	RD-4L 153J	15 K ohm J	$\frac{1}{4}$ W
R 314	RD-4L 183J	18 K ohm J	$\frac{1}{4}$ W
R 315	RD-4L 203J	20 K ohm J	$\frac{1}{4}$ W
R 316	RS-2P333J	33 K ohm J	$\frac{1}{2}$ W
R 317	RD-4L 104J	100K ohm J	$\frac{1}{4}$ W
R 320	RD-4L 124J	120K ohm J	$\frac{1}{4}$ W
R 322	RD-4L 224J	220K ohm J	$\frac{1}{4}$ W
R 323	RD-4L 433J	43 K ohm J	$\frac{1}{4}$ W
R 324	RD-4L 471J	470 ohm J	$\frac{1}{4}$ W
R 326	RD-4L 152J	1.5 K ohm J	$\frac{1}{4}$ W
R 329	RD-4L 101J	100 ohm J	$\frac{1}{4}$ W
R 331	RD-4M331J	330 ohm J	$\frac{1}{4}$ W
R 332	RD-4L 102J	1 K ohm J	$\frac{1}{4}$ W
R 333	RS01P682J	6.8 K ohm J	1 W
R 334	RD-2L 183J	18 K ohm J	$\frac{1}{2}$ W
R 336	RD-4L 221J	220 ohm J	$\frac{1}{4}$ W
R 337	5160122901	2.2 ohm J	$\frac{1}{2}$ W
R 338	RS-2P 150J	15 ohm J	$\frac{1}{2}$ W
R 339	5160112901	1.2 ohm J	$\frac{1}{2}$ W
R 340	RS01P220T	22 ohm J	1 W
R 401	RD-4L 153J	15 K ohm J	$\frac{1}{4}$ W
R 402	RD-4L 821J	820 ohm J	$\frac{1}{4}$ W
R 403	RD-4M561J	560 ohm J	$\frac{1}{4}$ W
R 404	RD-4M103J	10 K ohm J	$\frac{1}{4}$ W
R 405	RD-4M103J	10 K ohm J	$\frac{1}{4}$ W
R 406	RD-4L 272J	2.7 K ohm J	$\frac{1}{4}$ W
R 407	RD-4L 681J	680 ohm J	$\frac{1}{4}$ W
R 408	RS02P682J	6.8K ohm J	$\frac{1}{2}$ W
R 419	RD-4L 270J	27 ohm J	$\frac{1}{4}$ W
R 410	RD-4L 182J	1.8 K ohm J	$\frac{1}{4}$ W
R 411	RD-4L 151J	150 ohm J	$\frac{1}{4}$ W

REF NO PART NO DESCRIPTION

R 416	RD-2L 569J	5.6 ohm J	$\frac{1}{2}$ W
R 417	RS02P182J	1.8 K ohm J	2 W
R 418	RS01P123J	12 K ohm J	1 W
* R 420	RX05P220J	22 ohm J	5 W
* R 421	RD-2L 569J	5.6 ohm J	$\frac{1}{2}$ W
R 422	RD-4L 470J	47 ohm J	1 W
R 425	RD-4L 153J	15 K ohm J	$\frac{1}{4}$ W
R 426	RD-4L 153J	15 K ohm J	$\frac{1}{4}$ W
R 802	RD-2L 154J	150 K ohm J	$\frac{1}{2}$ W
R 804	RD-2L 684J	680 K ohm J	$\frac{1}{2}$ W
R 811	RD-2L 221J	220 Ω J	$\frac{1}{2}$ W
* R 901	RX20P251J	250 ohm J	20 W
R 902	RD-2L 101J	100 ohm J	$\frac{1}{2}$ W
R 903	RD-2L 123J	12 K ohm J	$\frac{1}{2}$ W
R 904	RD-2L 123J	12 K ohm J	$\frac{1}{2}$ W
R 905	RD-2L 223J	22 K ohm J	$\frac{1}{2}$ W
R 906	RD-2L 563J	56 K ohm J	$\frac{1}{2}$ W
R 907	RD-2L 563J	56 K ohm J	$\frac{1}{2}$ W
R 909	RD-2L 682J	6.8 K ohm J	$\frac{1}{2}$ W

CONTROLS

R 211	553102005E	1 K ohm Contrast
R 319	553104005B	100K ohm Vet Hold
R 321	553124008B	220K ohm Vet Height
R 327	553472008B	4.7 K ohm Vet Linearity
R 335	553102007B	1 K ohm Vet Balance
R 427	553303005B	30 K ohm Horiz Hold
R 803	553254005B	250K ohm Bright
R 805	553205005B	2 Mohm Focus
R 908	553472007B	4.7 K ohm B+ ADJ

CAPACITORS

C 201	CE2G1C470	47mF mF	16V
C 202	CE2G1F101	100mF	25V
C 203	CE2G1C220	22mF	16V
C 204	CE2G1H101	100mF	35V
C 205	CE2G1C220	2.2mF	16V
C 206	C1SL1H561K	660pF K	50V
C 207	CE2G0J221	220mF	16V

REPLACEMENT PARTS LIST

REF NO	PART NO	DESCRIPTION	REF NO	PART NO	DESCRIPTION
C 208	5270322401	0.22 mF M 400V	DISCHARGE GAPS		
C 210	CE2G1H220	22 mF 35V	Z 801	} 599030001	EGP-H751A or S-21
C 211	CE2G1H339	3.3 mF 50V	Z 802		
C 213	CK1F2H102K	0.001 mF 500V	Z 803		
C 220	CE2G2F330	3.3 mF 250V	SWITCHES		
C 301	CQ1M1H473K	0.047 mF K 50V	* SW-1	PE13-1567	115V/230V Power Line Slide Switch
C 304	CK1B1H391K	390pF K 50V	FUSES		
C 305	CE2G1H478	0.47 mF 50V	* F 902	6990620011	250V 2A
C 306	CQ1M1H333K	0.033 mF K 50V	* F 903	5990610013	250V 0.5A
C 307	CQ1M1H562K	0.0056 mF K 50V	MECHANICAL PARTS		
C 308	CQ1M1H273K	0.027 mF K 50V	* K 001	22-463020	Nate-N-Look Connector (AMP)
C 309	CQ1M1H123K	0.012 mF K 50V		S-A3915	Transistor Socket (SMK)
C 311	CQ1M1H124K	0.12 mF K 50V	* TM60085001	FUSE HOLDER	
C 312	CQ1M1H392K	0.0039 mF K 50V	* or TM60085001	FUSE HOLDER	
C 313	DS5D1C229M	2.2 mF 16V	K 005	1-380826-0	Stand OFF Fastener (AMP)
C 314	CQ1M1H474J	0.47 mF 50V	P 401	PE19-1569	4P Plug ASS' (Yoke Line)
C 315	CQ1M1H333K	0.033 mF K 50V	P 402	PE- 19-1570	4F Recep ASS' (Yoke Line)
C 316	CF2G1A470	47 mF 10V	P 403	PE19-1571	3P Connector ASS' (Video INPUT)
C 317	CE2G2A10J	100 mF 100V	A 621	PE19-1572	4P Connector ASS' (Q901 Line)
C 318	CK1E2H103K	0.01 mF 500V	A 631	PE19-1573	6P Connectpr ASS' (Q304 Q305 Line)
C 319	5270310301	0.01 mF 630V	P 406	PE19-1574	2P Plug ASS' (Heater Line)
C 401	CQ1M1H103K	0.01 mF K 50V	P 407	PE19-1575	2P Recep ASS' (Heater Line)
C 402	CQ1M1H103K	0.01 mF K 50V	TE901	PE19-1576	Terminator 6Pin
C 403	CQ1M1H393K	0.039 mF K 50V	E 001	135431015	Earth Plate
C 405	CE2G1H339	3.3 mF 50V	F 001	22-164001	Frame
C 406	CQ1M1H104K	0.1 mF K 50V	H 003	5432001 1	Plate Heat Sink A
C 407	CQ1M1H223K	0.022 mF KJ 50V	Q403D	54320011	Plate Heat Sink C
C 408	CQ1M1H683K	0.068 mF JJ 50V		4853711000	Supporter
C 409	CE2G1F470	47 mF 25V	Design and specifications are subject to change without notice.		
C 410	CK1B2H681K	680 pF K 500V			
C 411	CK1B2H222K	0.0022 mF K 500V			
C 412	CK1B1H152K	0.0015 mF K 50V			
C 413	C B1H102K	0.001 mF K 50V			
* C 414	CK1B3D471K	470 pF K 2KV			
C 415	CQ1M2A104K	0.1 mF K 100V			
* C 416	5270333201	0.0033 mF 1.5KV			
C 417	CE2G2C100	10 mF 160V			
C 418	5270333401	0.33 mF K 200V			
C 419	CE2W1V101	100 mF 35V			
C 420	56625471	470 mF 25V			
C 801	5270356302	0.056 mF K 630V			
C802	CKIE3C102P	1000pF 1.5KV			
* C 901	5240700400	450 mF 200V			
C 902		100 mF 160V			
C 904	F2G2C229	2.2 mF 160V			
C 905	CK1F2H102K	0.001 mF 500V			

SERVICEMAN RESISTANCE CHECK WARNING

Before returning the monitor to the customer make resistance measurement between each side of power supply circuit (P1-9 and P1-10) and chassis frame.

Resistance must exceed 5 meg ohms

Any measurements not within the limits outlined above are indicative of shock hazard and corrective action must be taken before returning the monitor to the customer.

SCHEMATIC DIAGRA

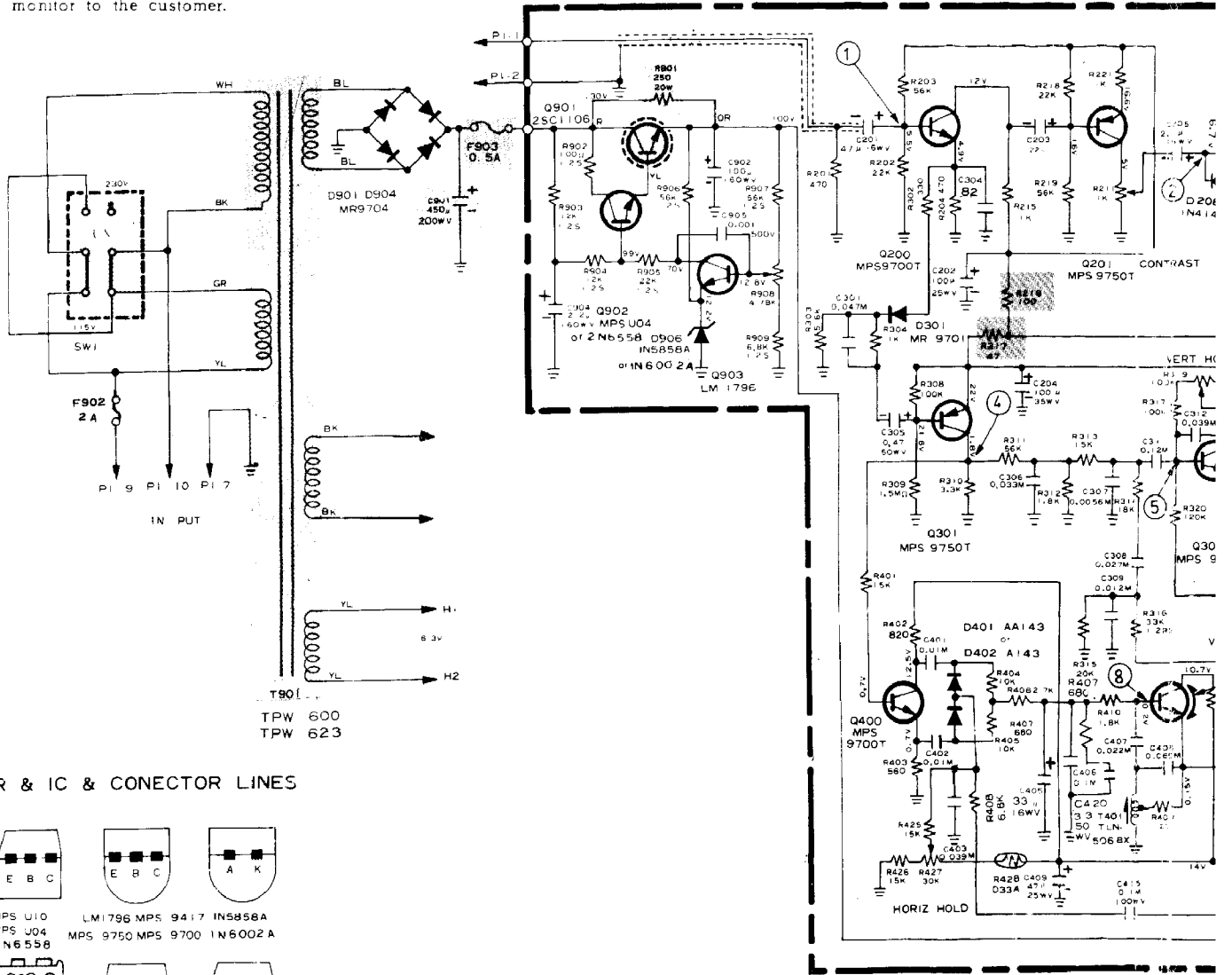

TR & IC & CONECTOR LINES

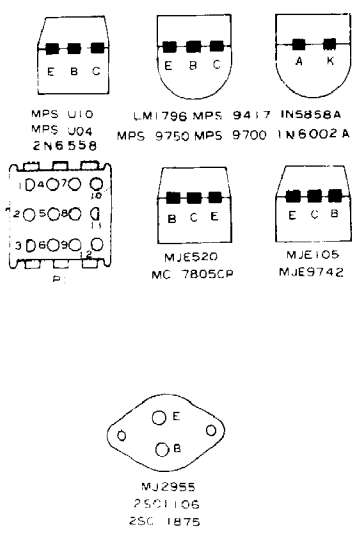

WAVE FORM

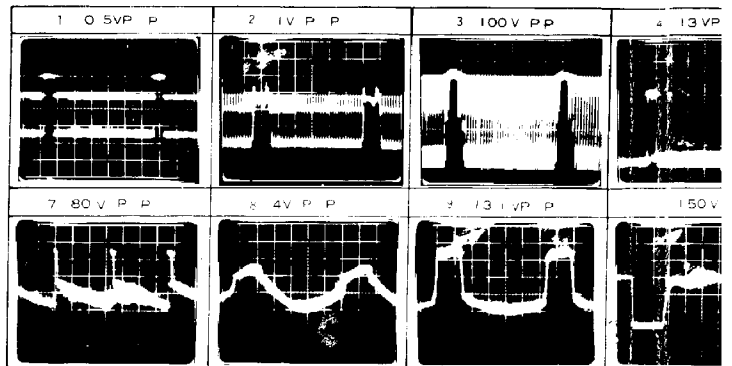

REPLACEMENT PARTS LIST

SAFETY CRITICAL COMPONENTS NOTE

FOR CONTINUED SAFETY REPLACE THOSE COMPONENTS INDICATED BY SHADING WITH EXACT REPLACEMENT PARTS ONLY. REFER "SAFETY CRITICAL COMPONENTS" OF SERVICE MANUAL'S REPLACEMENT PARTS LIST.

DIAGRAM

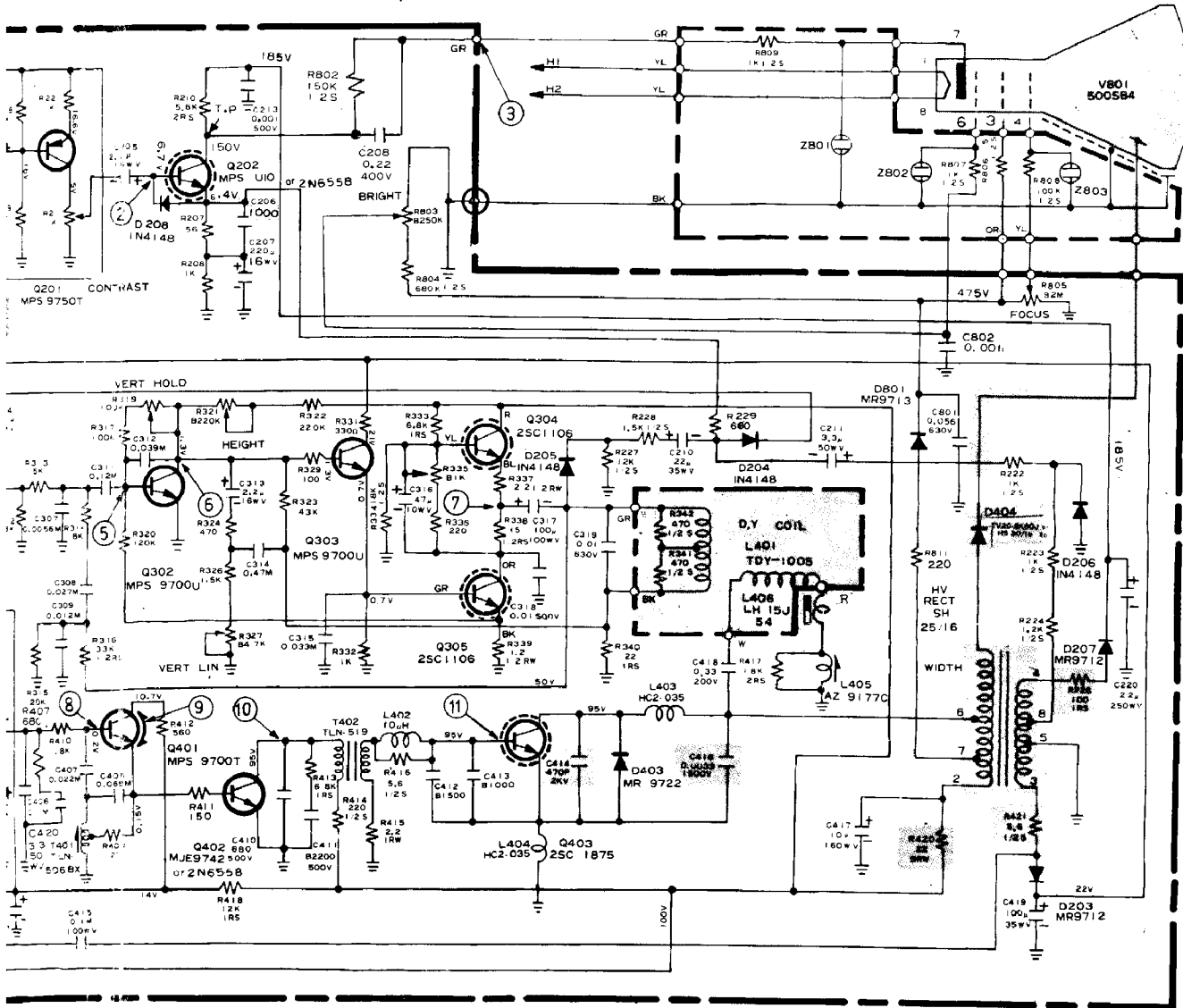

NOTES

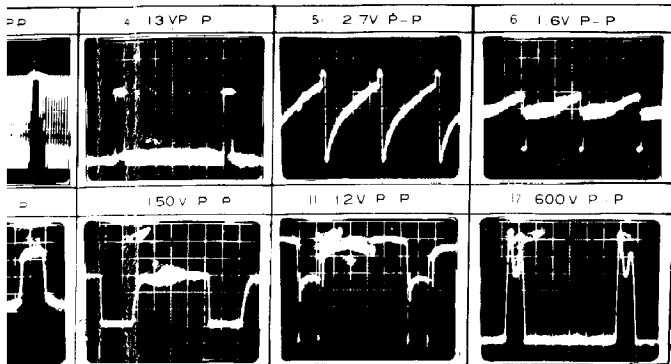

1. ALL RESISTANCE VALUES IN OHM K = 1,000 M = 1,000,000
2. UNLESS OTHERWISE NOTED IN SCHEMATIC DIAGRAM ALL CAPACITORS VALUES LESS THAN 1 ARE EXPRESSED IN MFD AND THE VALUES MORE THAN 1 ARE IN PFD
3. VOLTAGE READINGS ARE TAKEN WITH VTVM FROM POINT INDICATED TO CHASSIS TO GROUND
4. ALL WAVE FORMS ARE MEASURED WITH STRONG SIGNAL IN PUT CONTRAST SET TO GIVE NORMAL PICTURE
5. THIS SCHEMATIC DIAGRAM COVERS BASIC OR REPRESENTATIVE CHASSIS ONLY THERE MAY BE SOME COMPONENT OR PARTIAL SCHEMATIC DIFFERENCE BETWEEN ACTUAL CHASSIS AND THE SCHEMATIC DIAGRAM

WIRING

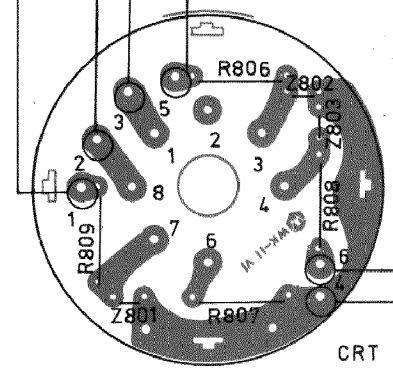
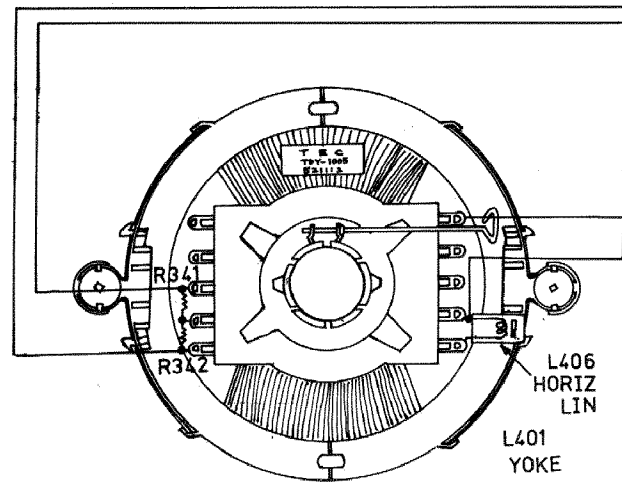
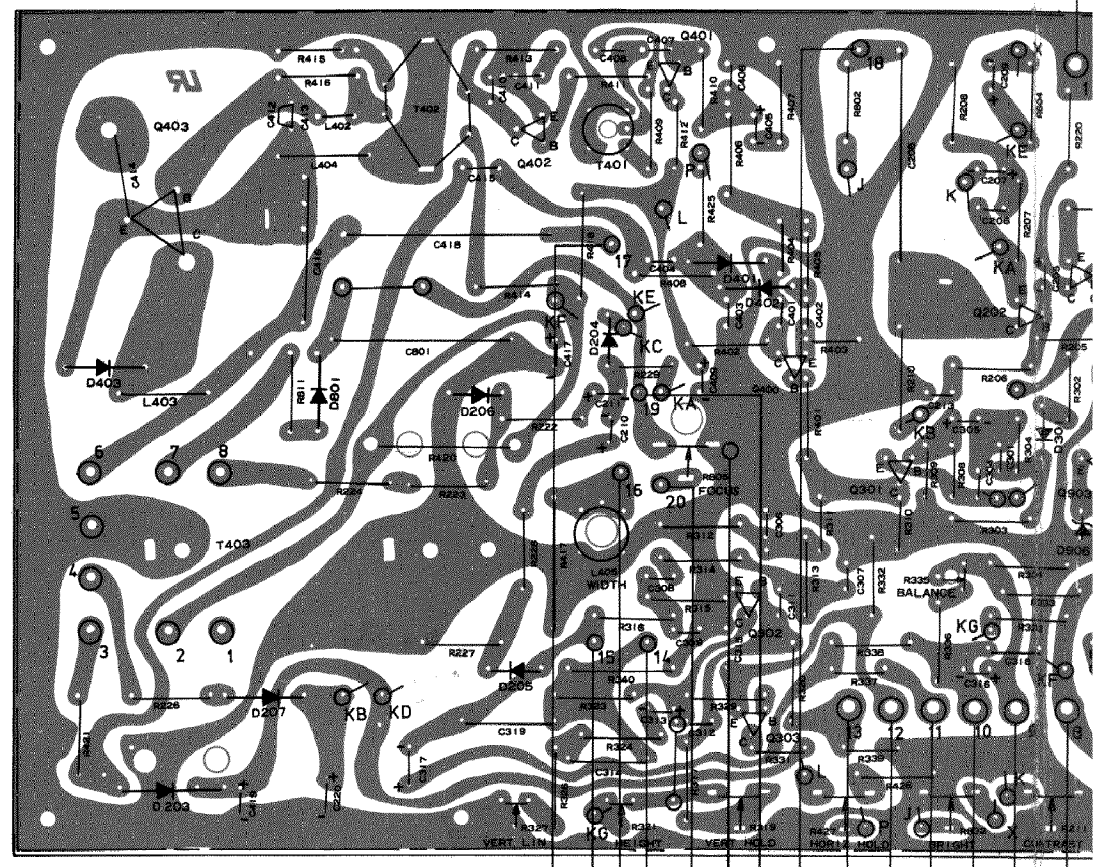
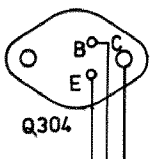
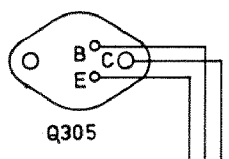

IRING DIAGRAM

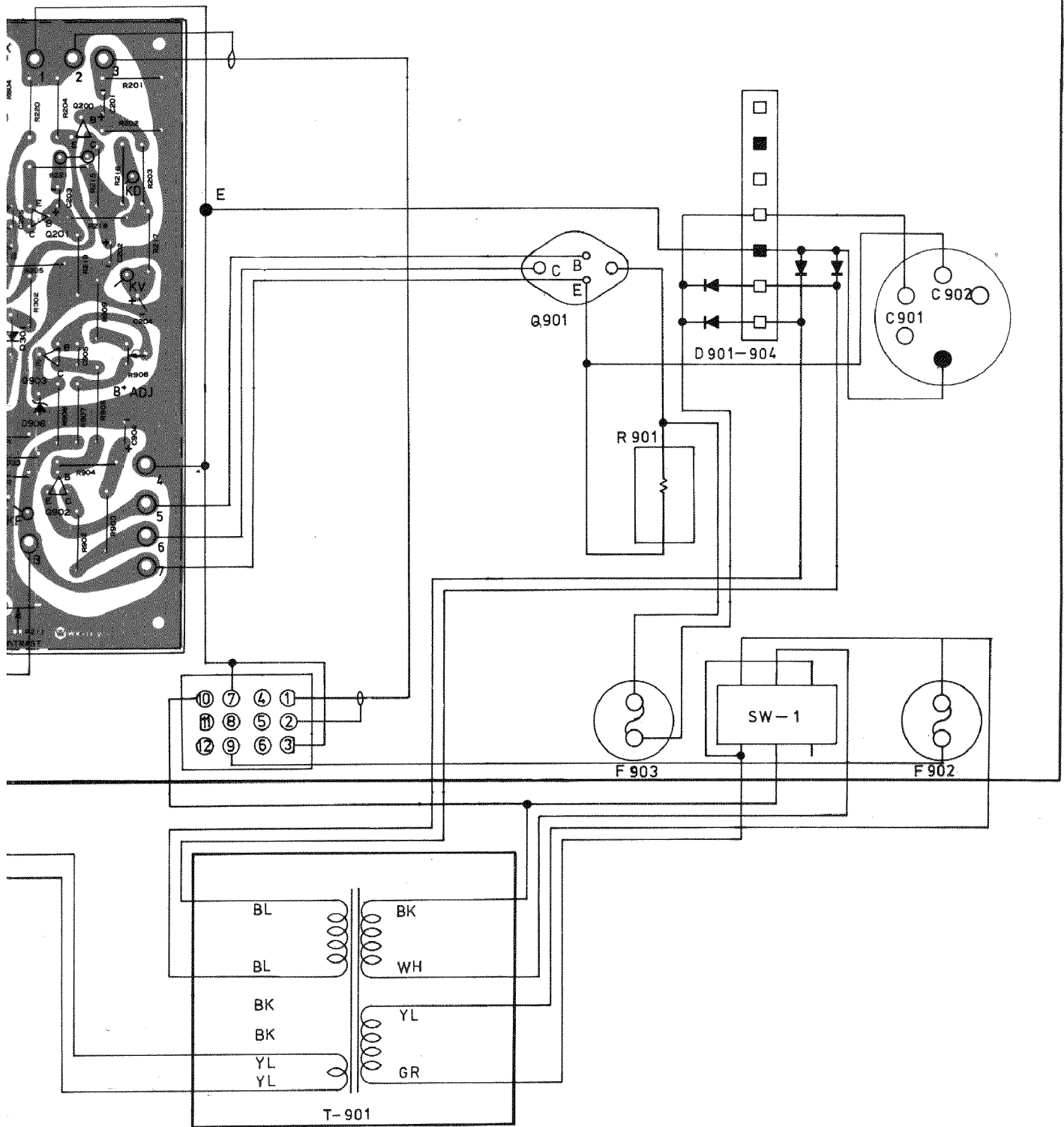

BOTTOM VIEW



TEC VIDEOELECTRONICS INC

**ADDRESS: 3190 CORONADO DRIVE,
SANTA CLARA, CA. 95050**

TEL : (408) 246-5428

TWX : 910 338 7633