

Find-It-In-Front: Dr. Pinball Section

The inside cover & the front pages
DR. ① thru DR. ⑩ covers the basics

A lot of questions get answered here...



NO YES END PREV QUIT ?

The Portals™ Service Menu,
Section 3, is your Technical Friend...



PINBALL, INC.

<http://www.SternPinball.com>
2020 Janice Ave., Melrose Park, IL 60160

MONOPOLY

Own it all.

Mr. Monopoly Property Trading Co.

TITLE DEED BOARDWALK	
RENT \$50.	
With 1 House	\$ 900.
With 2 Houses	600.
With 3 Houses	1400.
With 4 Houses	1700.
With HOTEL \$5000.	
Mortgage Value \$900.	
Houses cost \$200. each	
Hotels, \$900. plus 4 houses	

If a player owns all the properties on the board, the bank is bankrupt and the player is the owner of the game.

STERN
PINBALL, INC.
©2001 HASBRO, INC. All Rights Reserved

Your Parts Sales & Technical Support Team

Joe Blackwell
DIRECTOR,
Parts Sales &
Technical Support

Susan White
Parts
Sales
MANAGER

Patty Schraps
Parts
Stockroom
MANAGER

Chas Siddiqi
Technical
Support
ENGINEER

Jā Alfer
Technical Support
Documentation
ADMINISTRATOR

Please call us at 1-800-542-5377 or
1-708-345-7700 for Technical Support.
Visit us at our Web Site www.SternPinball.com.

Stern™ Pinball, Inc. © 2001
All Rights Reserved.
Printed in the U.S.A.
September 2001 - Print Copy: ①

SPI PN[®]:
780-5075-00

The Bubble Level is back!

This will ensure Game Pitch is 6.5° (recommended) for proper game play.



Leg Leveler Adjustment and use of the Bubble Level

On a LEVEL FLOOR, this cabinet is designed to automatically have a 6.5° pitch without adjusting levelers.

Start adjustment with the leg levelers turned all the way in.

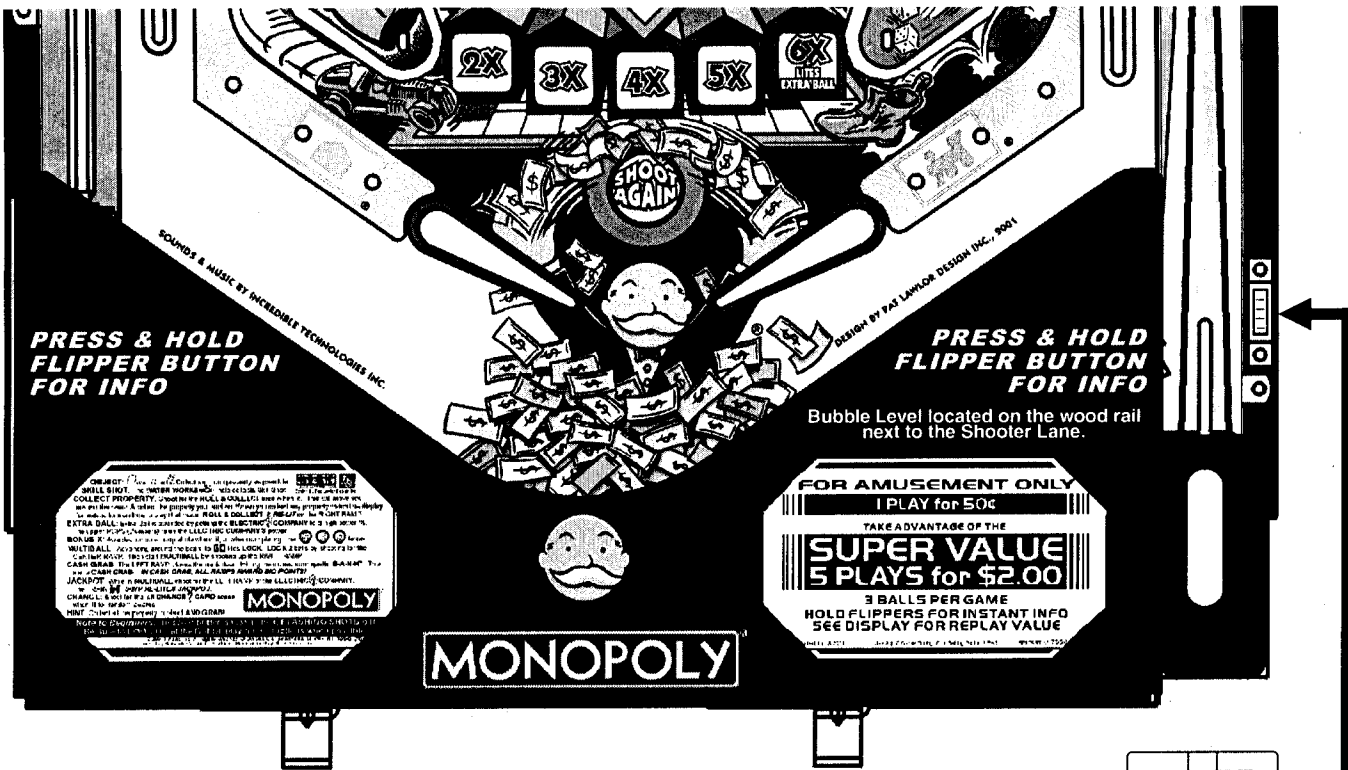

View the bubble in the level provided on the right side wood rail (see above).

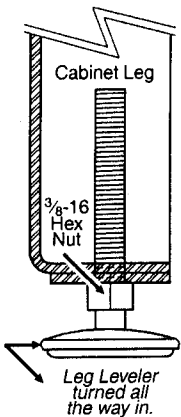

Adjust the front or rear levelers as necessary to cause the bubble to float between the two (2) black lines.

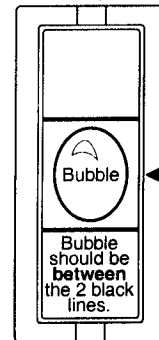

Use a pinball to roll down the center of the playfield for side-to-side leveling.

YOUR PLAYFIELD PITCH IS NOW AT 6.5° AS REQUIRED FOR PROPER GAME PLAY!

For custom adjustment greater than >6.5° can be achieved by turning out the rear leg leveler(s), however, it is not recommended.



New to our Pinball Games?

Don't forget to go over Section 3, Chapter 1, Portals™ Service Menu Introduction. If using Diagnostics...very useful! Got confused? Comments? Questions? Call Technical Support at 800-542-5377 or 708-345-7700 (Option 1).



Step 2.

Carefully pull the Backbox forward into the "down" position.

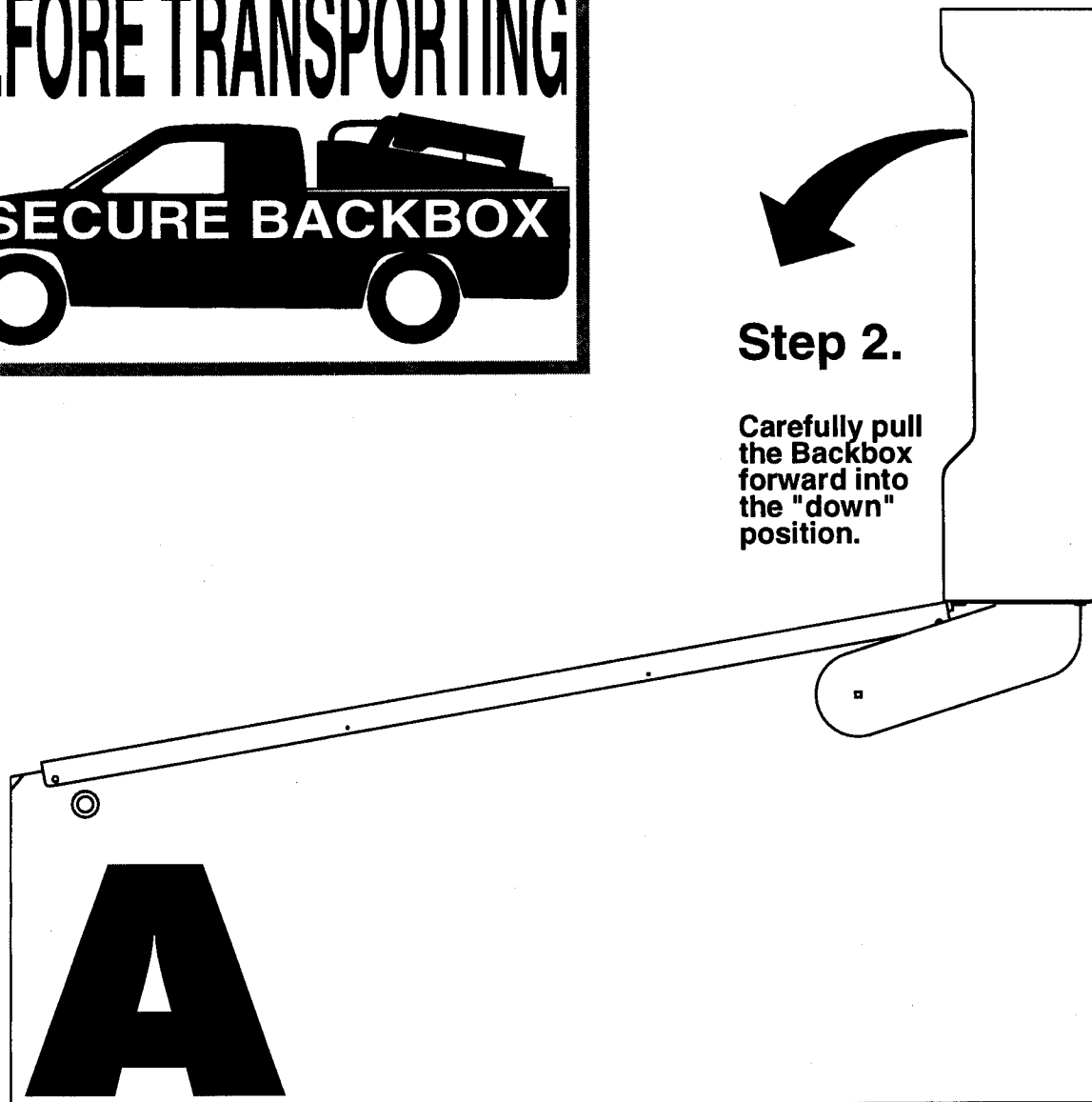

Step 1.

Unlock the Roto-Lock (Counter-Clockwise)

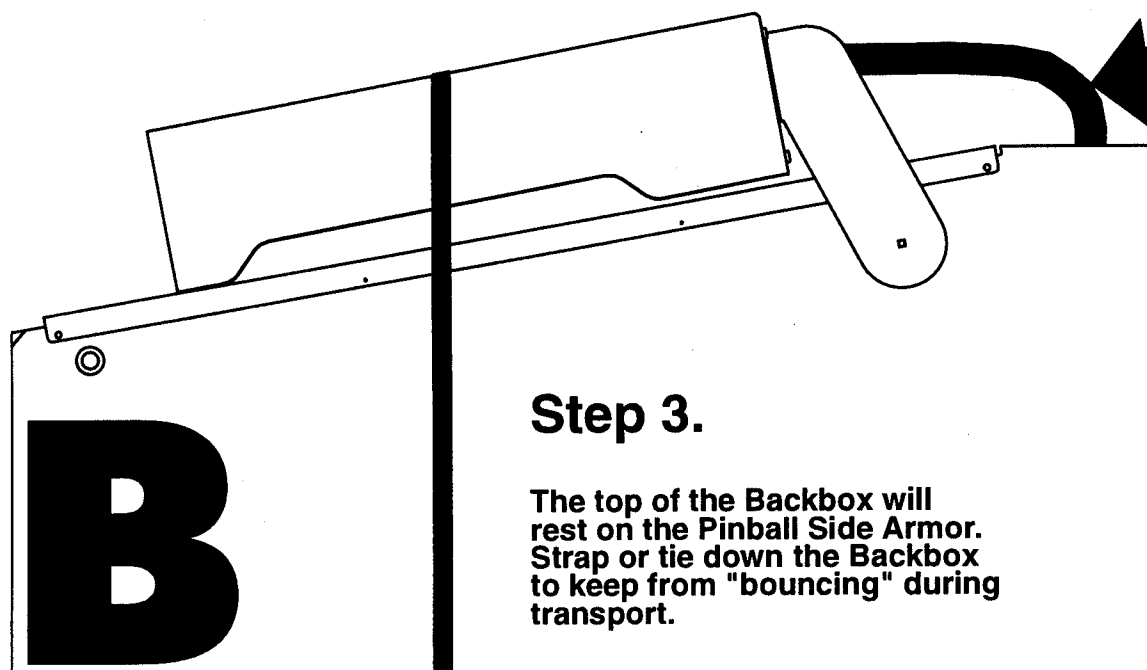

Step 3.

The top of the Backbox will rest on the Pinball Side Armor. Strap or tie down the Backbox to keep from "bouncing" during transport.

Ensure Cables do not bind, pinch or are being pulled tight. Hand-Feed out with Backbox so Cables are not tight.

How to Secure the Backbox for Transporting

For more Backbox details & part numbers, see Section 4, Chapter 1, Backbox Assembly, Pages 50-51.

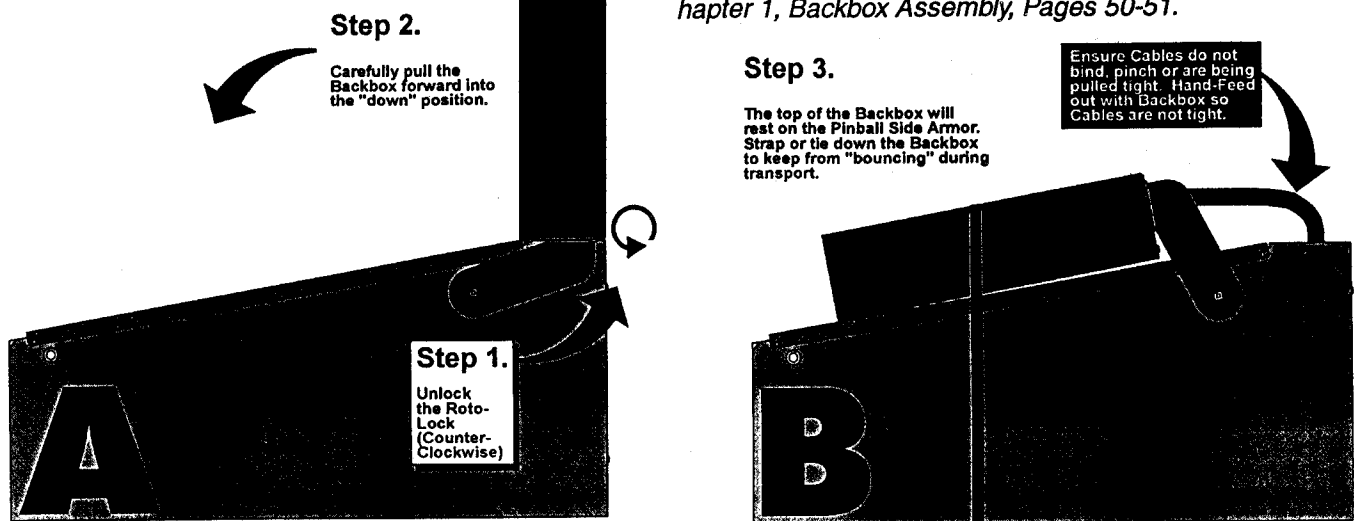

Leg Leveler Adjustment

On a LEVEL FLOOR, this cabinet is designed to automatically have a 6.5° pitch without adjusting levelers.

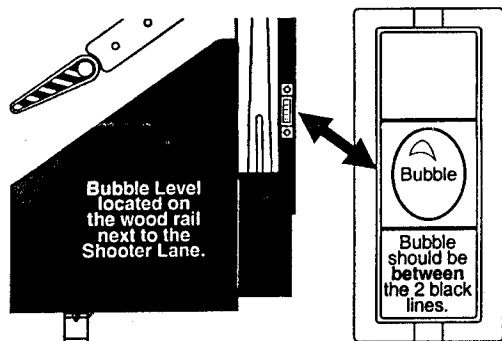

Attach the four (4) Leg Assemblies to cabinet corners with the eight (8) leg bolts provided (See Sec. 4, Chp. 1, Cabinet - General Parts & Switches, Page 52).

Start adjustment with the leg levelers turned all the way in. View the bubble in the level provided on the right side wood rail. Adjust the front or rear levelers as necessary to cause the bubble to float between the two (2) black lines. Use a pinball to roll down the center of the playfield for side-to-side leveling.

YOUR PLAYFIELD PITCH IS NOW AT 6.5° AS REQUIRED FOR PROPER GAME PLAY!

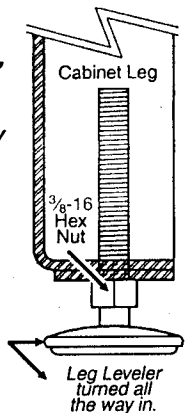

For custom adjustment greater than >6.5° can be achieved by turning out the rear leg leveler(s), however, it is not recommended.

Easy Access Service System - 3 Positions

With the front molding & glass removed, carefully lift the playfield (take care when using the Bottom Arch to hoist).

Positions 1 & 2

When lifted high enough, the **Playfield Support Slide Brackets** (Fig. 1A) can be seen & can clear the cabinet front. At this time, pull the playfield toward the front of the cabinet, checking that the mechanical components clear the cabinet front, then rest the playfield on the **Playfield Support Slide Brackets** at the front channel of cabinet (Fig. 1C); Or, the **Prop Rod** (located on the right inside of cabinet) can be used by positioning the **Prop Rod** end into the receiving playfield hole (Fig. 1B).

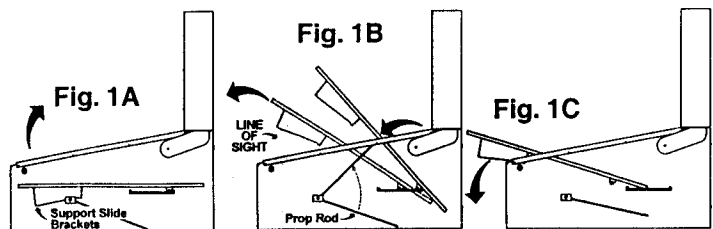

Position 3

With the playfield at rest, hold the sides & pull toward the front of the cabinet (approx. 6" to 8"), until resistance is felt from **Edge Slide Brackets** stopping against the **Slide & Pivot Support Brackets** located on either side of the cabinet (Fig. 2A). At this time, swivel the playfield toward the Backbox, then rest on the top edge (Fig. 2B & 2C).

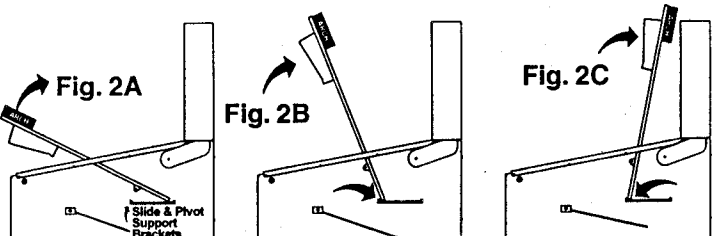

The Bubble Level is back!

This will ensure Game Pitch is 6.5° (recommended) for proper game play.

Le niveau à bulle est de retour! Celui-ci garantira l'inclinaison de 6,5° recommandée pour jouer sur le "Game Pitch".

Die Wasserwaage ist wieder da! Sie gewährleistet eine empfohlene Spielfeldnägung von 6,5°, die für ein ordnungsgemäßes Spiel erforderlich ist.

Ritorna la livella a bolla! Questo assicura l'inclinazione a 6,5° (raccomandata) per assicurare condizioni corrette per il gioco.

¡Regresa el Nivel de Burbuja! Esto garantiza que el campo de juego del Game Pitch esté a 6.5° (lo recomendado) para jugar apropiadamente.



Leg Leveler Adjustment and use of the Bubble Level

Réglage du niveau du pied et utilisation du niveau à bulle

Verstellen der Beine und Gebrauch der Wasserwaage

Regolazione dei livellatori delle gambe e uso della livella a bolla

Ajuste del nivelador de patas y uso del nivel de burbuja



Start adjustment with the leg levelers *turned all the way in*.

Commencer le réglage avec le mécanisme d'ajustement du pied entièrement à l'intérieur de celui-ci.

Beim Beginnen mit dem Verstellen müssen die Nivellier Vorrichtungen an den Beinen ganz nach innen gedreht sein.

Iniziare la regolazione con i livellatori delle gambe girati completamente all'interno.

Comience el ajuste con los niveladores de patas metidos totalmente hacia dentro.

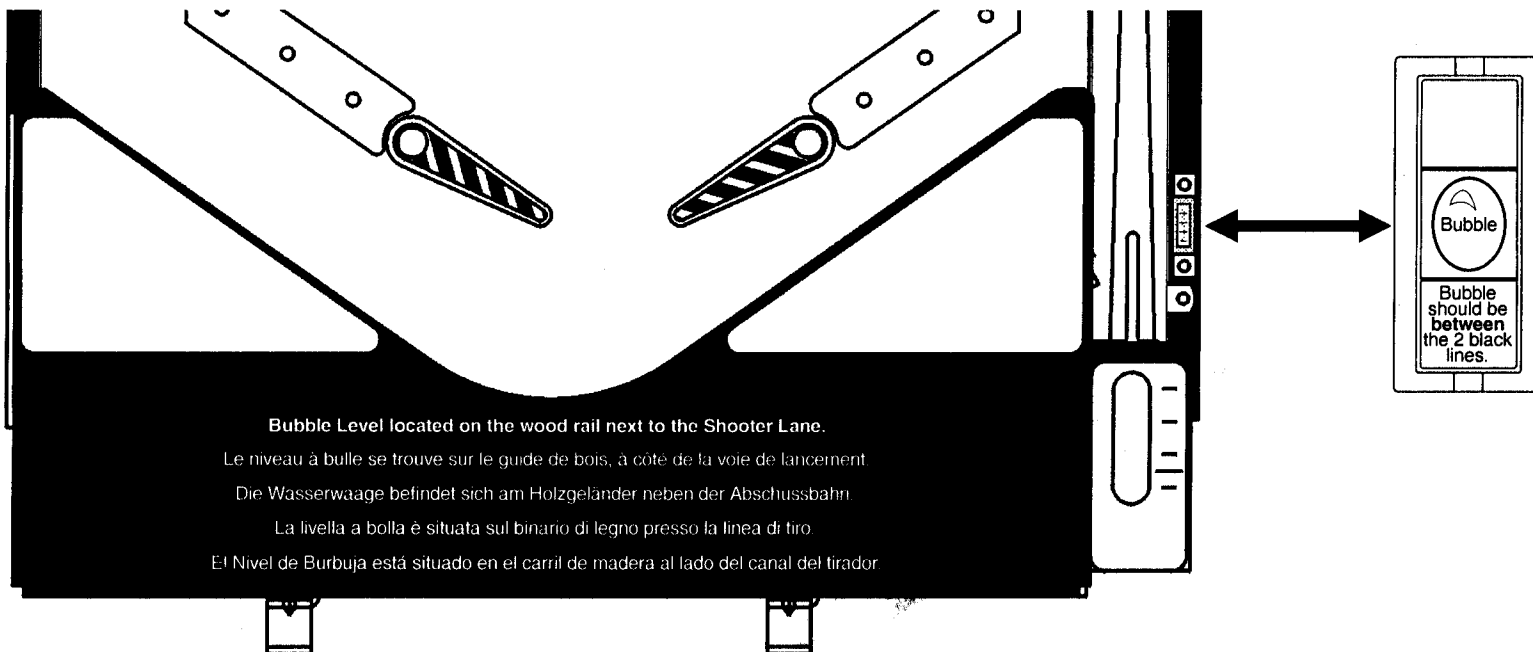

Bubble Level located on the wood rail next to the Shooter Lane.

Le niveau à bulle se trouve sur le guide de bois, à côté de la voie de lancement.

Die Wasserwaage befindet sich am Holzgeländer neben der Abschussbahn.

La livella a bolla è situata sul binario di legno presso la linea di tiro.

El Nivel de Burbuja está situado en el carril de madera al lado del canal del tirador.

View the *bubble* in the level provided on the right side wood rail (see above).

Observer la bulle à l'intérieur du niveau situé sur le guide de bois, à droite (voir ci-dessus).

Visieren Sie die „Blase“ in der Wasserwaage am rechten Holzgeländer an (siehe oben).

Osservare la "bolla" nella livella che si trova a destra del binario di legno (vedere più sopra).

Vea la *burbuja* en el nivel provisto en el carril de madera del lado derecho (vea arriba).

Adjust the front or rear leg levelers as necessary to cause the bubble to float between the 2 black lines.

Régler les dispositifs de mise à niveau à l'avant et à l'arrière de telle sorte que la bulle flotte entre les deux lignes.

Verstellen Sie bei Bedarf die vorderen oder hinteren Beine, so dass die Blase zwischen den beiden schwarzen Linien schwimmt.

Regolare i livellatori delle gambe anteriori o posteriori fino a che la bolla flotti tra le due linee nere.

Ajuste los niveladores de las patas delanteras o traseras según sea necesario para que la burbuja flote entre las dos líneas negras.

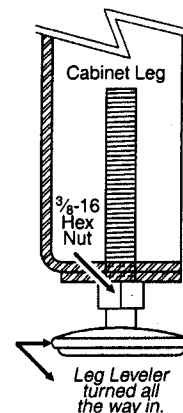

Use a pinball to roll down the center of the playfield for side-to-side leveling.

Faire rouler une balle vers le centre de l'aire de jeu pour niveler d'un côté à l'autre.

Lassen Sie einen Pinball in der Mitte des Spielfelds entlang rollen, um das Spielfeld seitlich zu nivellieren.

Usare un flipper per rotolare verso il basso al centro del campo di gioco per la livellazione lato a lato.

Use una bola que rueda hacia abajo por el centro del campo de juego para conseguir la nivelación de lado a lado.

▼ BACKBOX LAYOUT LOCATIONS: Fuses, Bridges, Relays & ROMs ▼

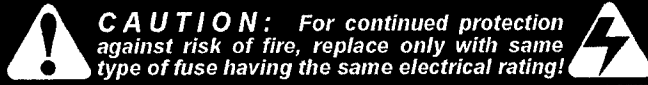

QUICK REFERENCE FUSE CHART

Backbox Fuses

LOC: DISPLAY POWER SUPPLY (P.S.) BOARD			
F1	3/4A 250v S.B.	90v DC	High Voltage Display
LOC: I / O POWER DRIVER BOARD			
F6	7A 250v S.B.	50v DC	Primary High Power Coils/Flippers
F7	5A 250v S.B.	20v DC	Low Power Coils
F8	5A 250v S.B.	12v DC	Logic Power
F9	5A 250v S.B.	12v DC	Logic Power
F20	3A 250v S.B.	50v DC	Magnet
F21	3A 250v S.B.	50v DC	Coils
F22	8A 250v S.B.	18v DC	Controlled Lamps
F23	4A 250v S.B.	5v DC	Logic
F24	5A 250v S.B.	6.3v AC	G.I. Lamps (BRN-WHT to WHT-BRN)
F25	5A 250v S.B.	6.3v AC	G.I. Lamps (YEL to WHT-YEL)
F26	5A 250v S.B.	6.3v AC	G.I. Lamps (GRN to WHT-GRN)
F27	5A 250v S.B.	6.3v AC	G.I. Lamps (VIO to WHT-VIO)
F28	3A 250v S.B.	24v AC	Not Used / Spare

Cabinet Fuses

LOC: SERVICE (AC) OUTLET BOX (Cabinet Bottom)			
n/a	8A 250v S.B.	115v AC	Main Fuse Line (Domestic or USA)
n/a	5A 250v S.B.	220v AC	Main Fuse Line (International)

Playfield Fuses

LOC: UNDER PLAYFIELD (near Flippers)			
n/a	3A 250v S.B.	50v DC	Rt. Flipper (BLU-YEL ↔ RED-YEL)
n/a	3A 250v S.B.	50v DC	Lt. Flipper (GRY-YEL ↔ RED-YEL)
n/a	3A 250v S.B.	50v DC	Upr. Flipper (GRY-YEL ↔ RED-YEL)

For other fuses, if any, locations & more information, see Page 95.

For Backbox & Cabinet General Parts, review Section 4, Chapter 1, Parts Identification & Location (The Pink Pages).
For Schematics and/or Component Parts on PC Boards shown, review Section 5, Chapter 4, Printed Circuit Boards (The Yellow Pages).

Display Power Supply Board

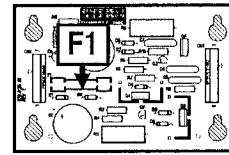

CPU / Sound Board

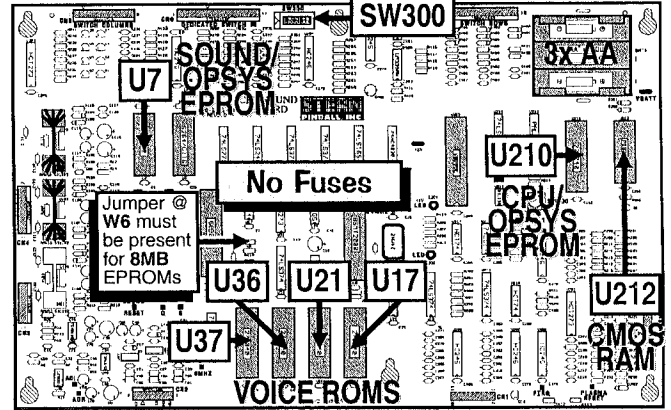

I/O Power Driver Board

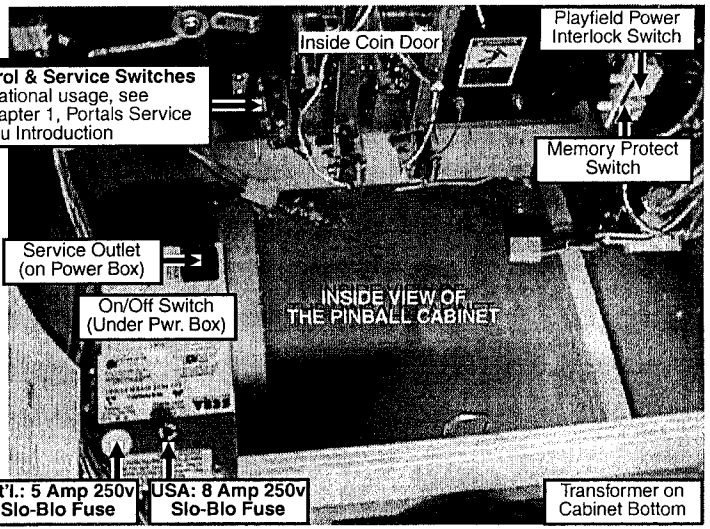
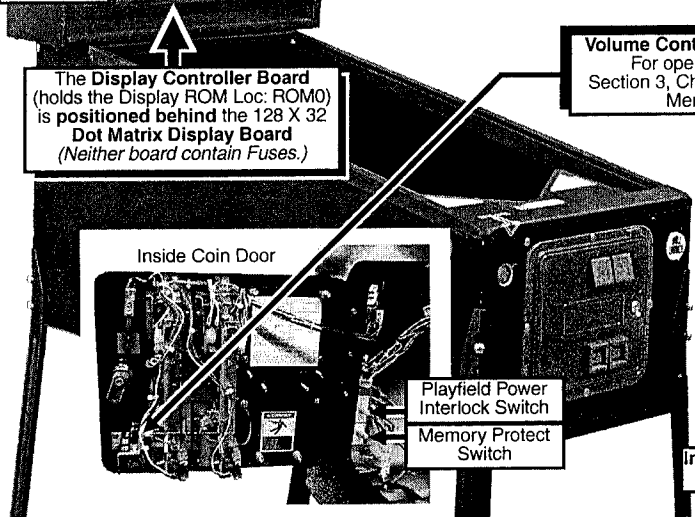
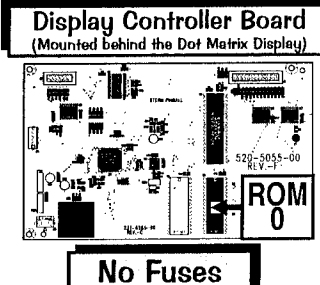
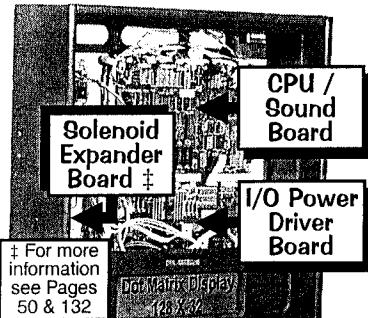
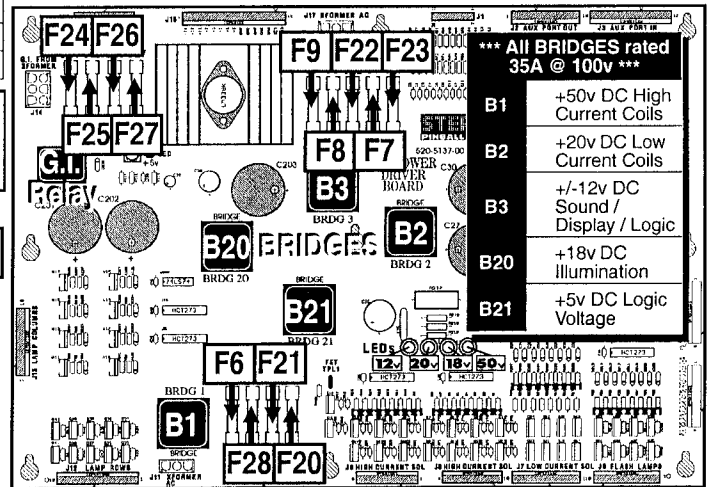

Find-It-In-Front:
Dr. Pinball



////// FIND-IT-IN-FRONT: Dr. Pinball Section Explained ////

The key technical data from various parts of the manual were extracted and combined into the "Find-It-In-Front: Dr. Pinball Section." This section (pages DR. ① - ⑩) will assist the technician in locating important technical information needed to troubleshoot the Pinball Machine. Dr. Pinball is also available in a Flow Chart Help Format in the Game Display. To access, enter the Portals™ Service Menu.

////// How It Works ////

First, the operator / technician must enter the **Service Menu Mode** (for a complete description of the Portals™ Service Menu and ICONS Read! Section 3, Chapter 1). To get into the **Service Menu Mode**, power-up the game (if not already) and open the **Coin Door**. On the **Coin Door** is the **Portals™ Service Switch Set** (Red, Green & Black Buttons).

Step 1: Push down the **Black "BEGIN TEST" Button**. Looking at the Video Display you will momentarily see the introductory screen followed by the **MAIN MENU**.

Step 2: Move through the Menus by pushing the **Red "LEFT"** or **Green "RIGHT"** Buttons.



Step 3: Select or activate the *Icons* by pushing the **Black "ENTER" Button**.

While in the **Portals™ Service Menu**, the **Start Button** can be used in lieu of the **Black Button**; the **Left & Right Flipper Buttons** can be used in lieu of the **Red & Green Buttons**. However, in *Switch or Active Switch Tests* **only** the **Red & Green Buttons** can be used.

 In our **Portals™ Service Menu**, selecting the "DR." *Icon* will bring the operator/technician into Dr. Pinball (Flow Chart Menus), the "on-screen" diagnostic aide. This is a feature that will allow you to utilize the power of the micro-processor assisting in troubleshooting a problem with the machine in a Flow Chart format (*Just follow along & answer the questions.*).

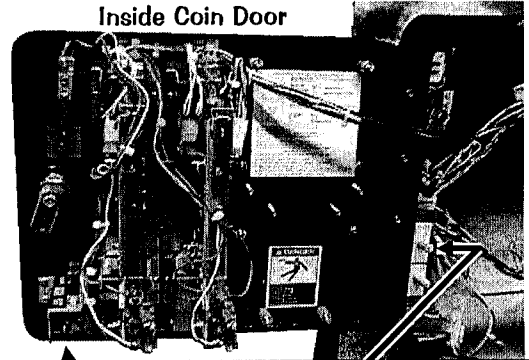

Inside Coin Door

If Coil & Flashlamp Testing, the Playfield Power Interlock Switch must be pulled out.

Portals™ Service Switch Set

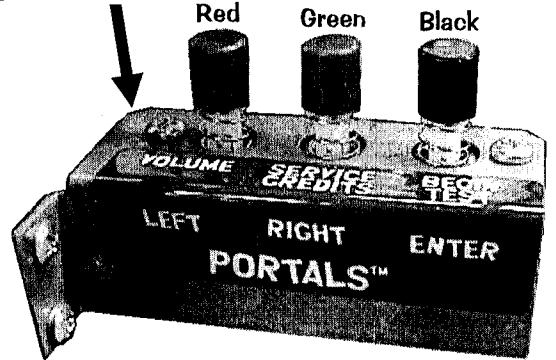

While in the **MAIN MENU**, select the "DIAG" *Icon*, then select the Cross "DR." *Icon* (the last *Icon* before the "PREV" *Icon*). This will bring you (the operator / technician) into **DR. PINBALL** (Flow Chart Menus) which offers you a choice of three (3) Sub-Menus: Coil "DR.," Switch "DR." & Lamp "DR." *Icons*. Selecting a particular sub-menu will give you a choice of which

specific Flipper, Coil, Switch or Lamp circuit needs to be diagnosed. The display will now ask a question or give a procedure to follow such as "Does the lamp turn on?" or "Check bridge rectifier BR-20, if short replace." When *Dr. Pinball* asks a question or requests a procedure, respond by selecting the appropriate *Mini-Icon*, and continue.



From the Main Menu in Portals™ GOTO DIAGNOSTICS MENU



From the Diagnostics Menu GOTO DR. PINBALL



From the Dr. Pinball Menu GOTO COIL, SWITCH OR LAMP FLOW CHARTS

The following are the *Mini-Icons* with explanations for the **Dr. Pinball Sub-Menus**:



Select a Coil, Lamp, Switch or Flipper to diagnose with the "-" or "+" *Icon*; select the "RUN" *Icon* to activate the choice. The "PREV" *Icon* goes back to previous question. The "QUIT" *Icon* exits Portals completely.



Seen when a question is being asked on the Display. Select the "YES" *Icon* or "NO" *Icon* to answer the question given. The "END" *Icon* lets you select a new item to test.



Seen when diagnosis is given. Select any *Icon* for your next step. The "?" *Icon* gives Help.



In Coil Flow Chart Menu, select the "PULSE" *Icon* to pulse the coil selected.

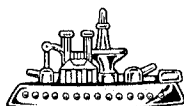

For proper operation of MONOPOLY® Pinball,



FOUR (4) PINBALLS MUST BE INSTALLED!

DIAGNOSTIC AIDS

The display reads "OPERATOR ALERT..."

— A message displayed during Game Mode or Power-Up to alert the operator of a problem.

OPERATOR ALERT works by monitoring any *switch activated coil* that has the potential to trap a ball when disabled (e.g. in the Auto Launch, Scoop, Eject, etc.). If this assembly has a closed switch indicating a ball is stuck or the switch is *stuck closed*, the **CPU/Sound Board** will activate the coil ten times. If the switch remains closed, the game will display a message indicating there is a problem (e.g. "**OPERATOR ALERT AUTO LAUNCH NOT WORKING**"). This not only warns the operator of a problem immediately, but indicates exactly where the operator should look to resolve it.

The display flashes "OPEN THE COIN DOOR"

— This indicates that CMOS RAM memory (CPU Loc. U212) has been corrupted.

This is caused by either failure in memory (e.g. batteries are dead or faulty **RAM**) or upon installation of updated version of code. Opening the Coin Door will initiate a Factory Restore, by opening the Memory Protect Switch. Check battery voltage at **VBATT Test Point** on the **CPU/Sound Board**.

CPU DIP SWITCH SETTINGS

Location of Dip Switch [SW300] is on the CPU/Sound Board (Right of CN6, Top Mid)

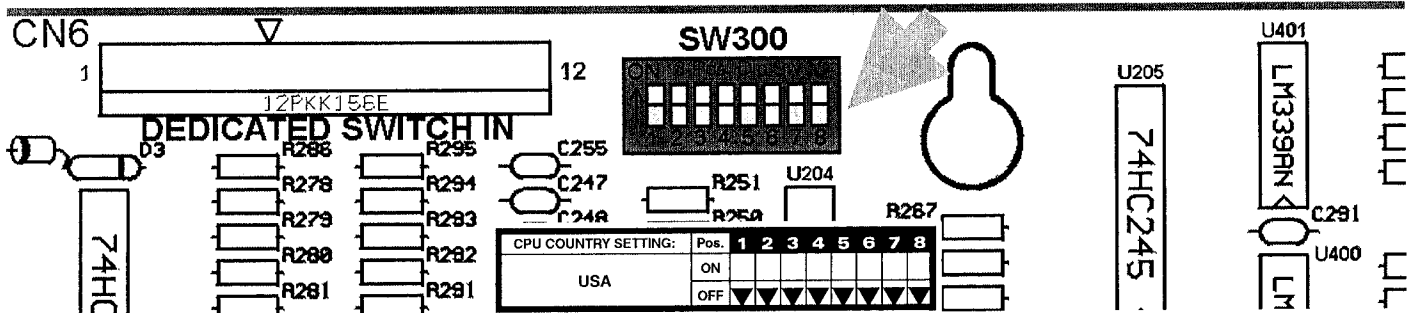

Custom Factory Adjustments By Country (All countries not noted use the "USA Setting")

CPU COUNTRY SETTING:	Pos.	1	2	3	4	5	6	7	8
EURO	ON	▲	▲	▲	▲	▼	▼	▼	▼
	OFF	▼	▼	▼	▼	▼	▼	▼	▼
AUSTRIA	ON	▲	▼	▼	▼	▼	▼	▼	▼
	OFF	▼	▼	▼	▼	▼	▼	▼	▼
BELGIUM	ON	▼	▲	▼	▼	▼	▼	▼	▼
	OFF	▼	▼	▼	▼	▼	▼	▼	▼
BRAZIL	ON	▲	▲	▼	▼	▼	▼	▼	▼
	OFF	▼	▼	▼	▼	▼	▼	▼	▼
CANADA	ON	▲	▲	▼	▼	▼	▼	▼	▼
	OFF	▼	▼	▼	▼	▼	▼	▼	▼
FRANCE	ON	▲	▲	▼	▼	▼	▼	▼	▼
	OFF	▼	▼	▼	▼	▼	▼	▼	▼
GERMANY	ON	▲	▲	▲	▼	▼	▼	▼	▼
	OFF	▼	▼	▼	▼	▼	▼	▼	▼
ITALY	ON	▼	▼	▼	▲	▼	▼	▼	▼
	OFF	▼	▼	▼	▼	▼	▼	▼	▼
JAPAN	ON	▲	▼	▲	▼	▼	▼	▼	▼
	OFF	▼	▼	▼	▼	▼	▼	▼	▼
NETHERLANDS (HOLLAND / DUTCH)	ON	▼	▲	▼	▼	▼	▼	▼	▼
	OFF	▼	▼	▼	▼	▼	▼	▼	▼
NORWAY	ON	▼	▼	▲	▼	▼	▼	▼	▼
	OFF	▼	▼	▼	▼	▼	▼	▼	▼
SWEDEN	ON	▲	▲	▲	▼	▼	▼	▼	▼
	OFF	▼	▼	▼	▼	▼	▼	▼	▼
SWITZERLAND	ON	▼	▼	▲	▲	▼	▼	▼	▼
	OFF	▼	▼	▼	▼	▼	▼	▼	▼
UK	ON	▲	▲	▼	▼	▼	▼	▼	▼
	OFF	▼	▼	▼	▼	▼	▼	▼	▼
UK FOR NEW 50p, 2E COIN MECH	ON	▲	▲	▲	▼	▼	▼	▼	▼
	OFF	▼	▼	▼	▼	▼	▼	▼	▼

ROM SUMMARY TABLE

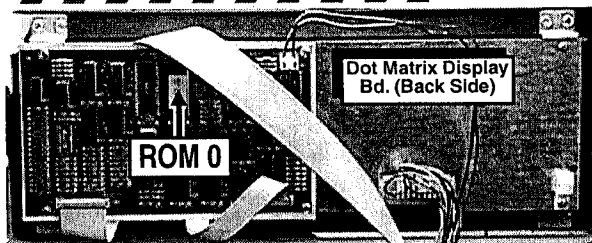

The Display Controller Board (holds the Display ROM Loc. ROM0) is positioned behind the 128 X 32 Dot Matrix Display Board.

I.C. NAME	TYPE	BD. NAME	LOC.	PART N°
Game ROM	1MB	CPU / Sound Bd.	U210	965-0360-75
Sound EPROM	512K	CPU / Sound Bd.	U7	965-0361-75
Display EPROM	4MB	Display Cntrl. Bd.	ROM 0	965-0362-75
Display EPROM	N/C	Display Cntrl. Bd.	ROM 1	N/A
Voice ROM 1	8MB	CPU / Sound Bd.	U17	965-0363-75
Voice ROM 2	8MB	CPU / Sound Bd.	U21	965-0364-75
Voice ROM 3	8MB	CPU / Sound Bd.	U36	965-0365-75
Voice ROM 4	8MB	CPU / Sound Bd.	U37	965-0366-75

For Game, Sound & Voice ROM Locations see DR. ①.



Find-It-In-Front:
Dr. Pinball





From the Main Menu in Portals
GO TO
DIAGNOSTICS MENU

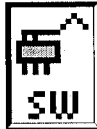

From the Diagnostics Menu
GO TO
SWITCH MENU



From the Switch Menu
GO TO SWITCH OR
ACTIVE SWITCH TEST



From the Switch Menu
GO TO DEDICATED
SWITCH TEST

SWITCH MATRIX GRID & DEDICATED SWITCHES

D iode O n T ermi n a l S tri p :		SWITCH MATRIX GRID								GND	
Column (Drive)	1: Q1	2: Q2	3: Q3	4: Q4	5: Q5	6: Q6	7: Q7	8: Q8	Ground		
Row (Return)	GRN-BRN CN5-P1	GRN-RED CN5-P3	GRN-ORG CN5-P4	GRN-YEL CN5-P5	GRN-BLK CN5-P6	GRN-BLU CN5-P7	GRN-VIO CN5-P8	GRN-GRY CN5-P9	BLK CN6-P1, -P11		
1: U400	LEFT BUTTON (UK ONLY) on Cabinet side	CHANCE SCOOP On Assembly	LEFT TOP LANE (A) Under Playfield	RIGHT ORBIT Under Playfield	BANK OPTO 1 (L) On Assembly	LOWER BOTTOM POP On Assembly	UPPER LEFT POP On Assembly	LEFT OUTLANE Under Playfield	1: U206	#1 LEFT FLIPPER BUTTON in Cabinet side	
2: U400	4TH COIN SLOT On Coin Door	RAILROAD RAMP Above Playfield	MIDDLE TOP LANE (B) Under Playfield	ELECTRIC COMPANY On Assembly	BANK OPTO 2 On Assembly	LOWER RIGHT POP On Assembly	UPPER RIGHT POP On Assembly	LEFT RETURN LANE Under Playfield	2: U206	#2 LEFT FLIPPER E.O.S (End-of-Stroke) on Flipper Assy	
3: U400	6TH COIN SLOT On Coin Door	4-BALL TROUGH #1 On Assembly	RIGHT TOP LANE (C) Under Playfield	DICE EJECT LANE Under Playfield	BANK OPTO 3 On Assembly	LOWER LEFT POP On Assembly	UPPER BOTTOM POP On Assembly	LEFT SLINGSHOT On Assembly	3: U206	#3 RIGHT FLIPPER BUTTON in Cabinet side	
4: U400	RIGHT COIN SLOT On Coin Door	4-BALL TROUGH #2 On Assembly	LOCKUP 1 (TOP) Under Playfield	LEFT ORBIT Under Playfield	BANK OPTO 4 (R) On Assembly	100K STANDUP Under Playfield	DICE EJECT On Assembly	RIGHT OUTLANE Under Playfield	4: U206	#4 RIGHT FLIPPER E.O.S (End-of-Stroke) on Flipper Assy	
5: U401	CENTER COIN SLOT / DBA On Coin Door	4-BALL TROUGH #3 On Assembly	LOCKUP 2 Under Playfield	WATERWORKS EJECT On Assembly	NOT USED	SPINNER On Assembly	NOT USED	RIGHT RETURN LANE Under Playfield	5: U206	#5 UPPER FLIPPER (Double Stacked with DS-3) in Cabinet side	
6: U401	LEFT COIN SLOT On Coin Door	4-BALL TROUGH VUK OPTO On Assembly	LOCKUP 3 (BOTTOM) Under Playfield	WWORKS MINI FLIPPER On Assembly	COP DROP TARGET On Assembly	COP STANDUP X2 Under Playfield	START BUTTON Cabinet Front	RIGHT SLINGSHOT On Assembly	6: U206	#6 VOLUME (RED BUTTON) (In Test: LEFT) on Coin Door	
7: U401	5TH COIN SLOT On Coin Door	4-BALL STACKING OPTO On Assembly	NOT USED	CENTER RAMP On Ramp Arm	LEFT RAMP MID On Ramp Arm	FREE PARKING Above Playfield	SLAM TILT On Coin Door	NOT USED	7: U206	#7 SERV. CRED. (GREEN BUTTON) (In Test: RIGHT) on Coin Door	
8: U401	RIGHT BUTTON (UK ONLY) on Cabinet side	SHOOTER LANE Under Playfield	NOT USED	NOT USED	NOT USED	RIGHT RAMP On Ramp Arm	PLUMB BOB TILT Inside Cabinet	NOT USED	8: U206	#8 BEGIN TEST (BLACK BUTTON) (In Test: ENTER) on Coin Door	



From the Diagnostics Menu
GO TO
LAMP MENU



From the Lamp Menu
GO TO
SINGLE LAMP TEST



From the Lamp Menu
GO TO
TEST ALL LAMPS

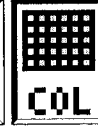

From the Lamp Menu
GO TO ROW OR
COLUMN TEST

LAMP MATRIX GRID

D iode O n T ermi n a l S tri p :		LAMP MATRIX GRID							
Column (18v)	1: U17	2: U16	3: U15	4: U14	5: U13	6: U12	7: U11	8: U10	
Row (GND)	YEL-BRN J13-P9	YEL-RED J13-P8	YEL-ORG J13-P7	YEL-BLK J13-P6	YEL-ORN J13-P5	YEL-BLU J13-P4	YEL-VIO J13-P3	YEL-GRY J13-P1	
1: Q33	LEFT OUTLANE #555 Bulb	BONUS 2X #555 Bulb	BONUS 3X #555 Bulb	BONUS 4X #555 Bulb	BONUS 5X #555 Bulb	BONUS 6X #555 Bulb	SHOOT AGAIN #555 Bulb	RIGHT OUTLANE #555 Bulb	
2: Q34	GO #555 Bulb	MEDITER-RANEAN #555 Bulb	COMM CHEST #555 Bulb	BALTIC #555 Bulb	READING RR #555 Bulb	ORIENTAL #555 Bulb	VERMONT #555 Bulb	CONNECTICUT #555 Bulb	
3: Q35	IN JAIL #555 Bulb	ST CHARLES #555 Bulb	STATES #555 Bulb	VIRGINIA #555 Bulb	PENN RR #555 Bulb	ST JAMES #555 Bulb	TENNESSEE #555 Bulb	NEW YORK #555 Bulb	
4: Q36	FREE PARKING #555 Bulb	KENTUCKY #555 Bulb	INDIANA #555 Bulb	ILLINOIS #555 Bulb	B.O. RR #555 Bulb	ATLANTIC #555 Bulb	VENTNOR #555 Bulb	MARVIN GARDENS #555 Bulb	
5: Q37	GO TO JAIL #555 Bulb	PACIFIC #555 Bulb	NORTH CAROLINA #555 Bulb	PENNSYLVANIA #555 Bulb	SHORT LINE RR #555 Bulb	CHANCE #555 Bulb	PARK PLACE #555 Bulb	BOARDWALK #555 Bulb	
6: Q38	LOWER BOTTOM POP #555 Bulb	LOWER LEFT POP #555 Bulb	RELIGHT JACKPOT #555 Bulb	RAILROAD LIT #555 Bulb	L BONUS X #555 Bulb	LOWER RIGHT POP #555 Bulb	COMM CHEST LIT #555 Bulb	FREE PARKING #555 Bulb	
7: Q39	CHANCE LIT #555 Bulb	3000 WHEN FLASHING #555 Bulb	ROLL #555 Bulb	SUPER JACKPOT #555 Bulb	WATERWORKS 1X #555 Bulb	WATERWORKS 2X #555 Bulb	WATERWORKS 4X #555 Bulb	R BONUS X #555 Bulb	
8: Q40	LEFT TOP LANE (A) #555 Bulb	MIDDLE TOP LANE (B) #555 Bulb	RIGHT TOP LANE (C) #555 Bulb	UPPER LEFT POP #555 Bulb	UPPER RIGHT POP #555 Bulb	UPPER BOTTOM POP #555 Bulb	ROLL AND COLLECT #555 Bulb	EXTRA BALL #555 Bulb	
9: Q41	BA (N) K #555 Bulb	BAN (K) #555 Bulb	LOCK #555 Bulb	COP #555 Bulb	BUILD #555 Bulb	JACKPOT #555 Bulb	(B) ANK #555 Bulb	B (A) NK #555 Bulb	
10: Q42	MOVE 2 #555 Bulb	LITE ROLL #555 Bulb	MULTIBALL #555 Bulb	100,000 #555 Bulb	LITE SPINNER #555 Bulb	POWER UP #555 Bulb	WATER BONUS X #555 Bulb	ADVANCE TO GO #555 Bulb	



SWITCH MATRIX GRID LOCATIONS

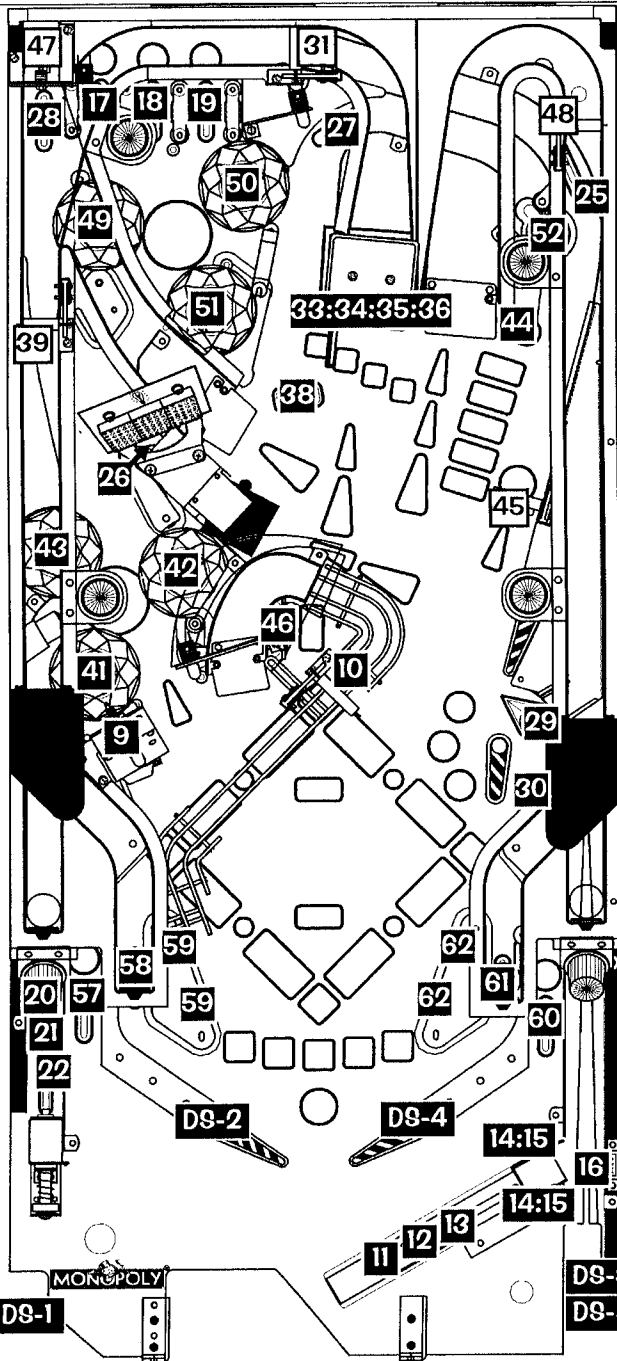

LAMP MATRIX GRID LOCATIONS

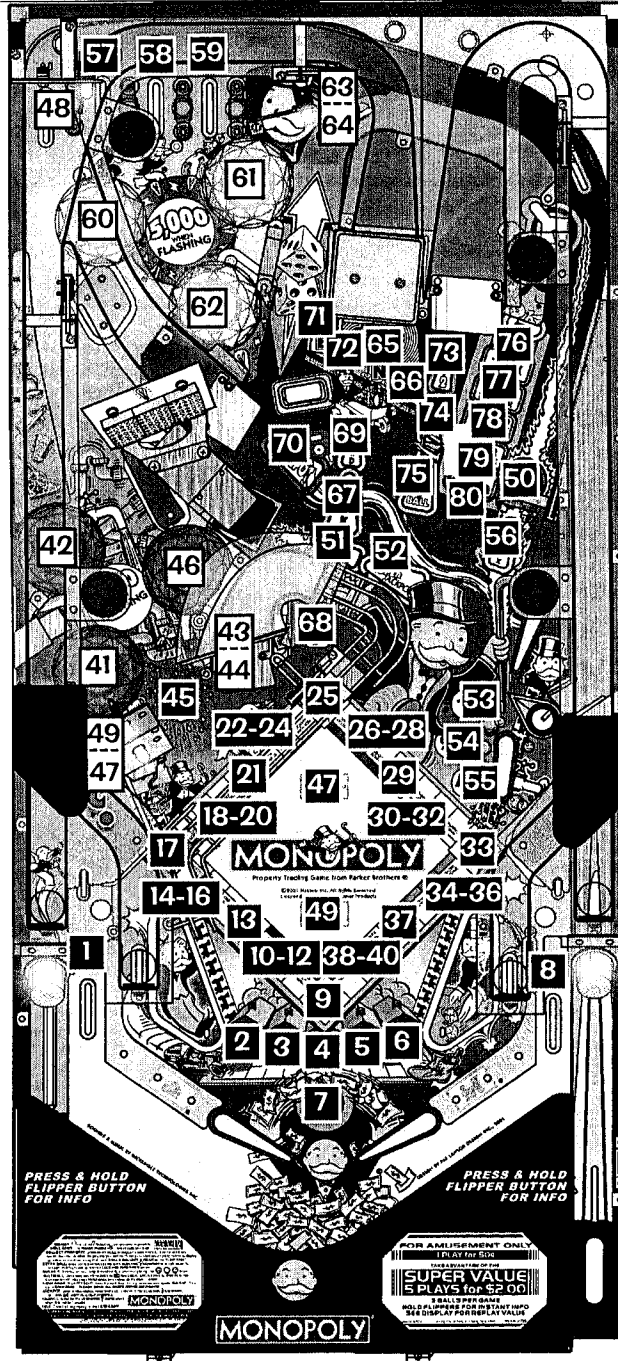

Legend Note: = Switches/Lamps mounted above P/F. = Switches/Lamps mounted below the P/F. = ...mounted on Cabinet.

TYPICAL SWITCH SCHEMATIC

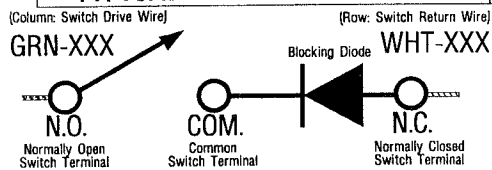

DEDICATED SWITCH SCHEMATIC

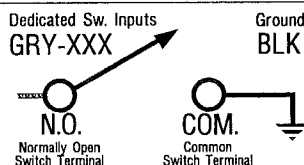

TYPICAL LAMP SCHEMATIC

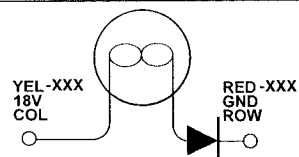

Note:
All Switches require diodes. Some diodes are located on Terminal Strips OR Diode Boards (under playfield) & not on the switch itself.

D iode
O n
T erminal
S trip

D iode
O n
T erminal
B oard

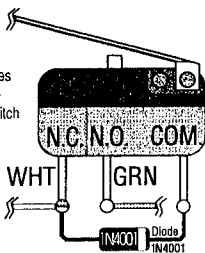

Note:
All Lamps require diodes. Some diodes are located on Terminal Strips (under playfield) & not on the lamp itself.

D iode
O n
T erminal
S trip

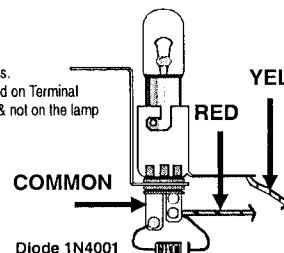

Dr. Pinball
Find-It-In-Front:





From the Main Menu in Portals™ GO TO DIAGNOSTICS MENU



From the Diagnostics Menu GO TO COIL MENU



From the Coil Menu GO TO COIL TEST



From the Coil Menu GO TO CYCLING COILS

COILS DETAILED CHART TABLE

High Current Coils Group 1		Drive Transistor (D.T.)	Driver Output Board	D.T. Control Line Color	D.T. Control Line Connect	Power Line Color	Power Line Connection	Power Voltage	Coil (GA-Turn) or Bulb Part #
#1	TROUGH UP-KICKER	Q1	I/O Pwr. Drvr.	BRN-BLK	J8-P1	YEL-VIO	J10-P4/5	50v DC	26-1200 090-5044-00T
#2	AUTO LAUNCH	Q2	I/O Pwr. Drvr.	BRN-RED	J8-P3	YEL-VIO	J10-P4/5	50v DC	23-700 090-5022-00T
#3	LOWER LEFT POP	Q3	I/O Pwr. Drvr.	BRN-ORG	J8-P4	YEL-VIO	J10-P4/5	50v DC	26-1200 090-5044-00T
#4	LOWER RIGHT POP	Q4	I/O Pwr. Drvr.	BRN-YEL	J8-P5	YEL-VIO	J10-P4/5	50v DC	26-1200 090-5044-00T
#5	LOWER BOTTOM POP	Q5	I/O Pwr. Drvr.	BRN-GRN	J8-P6	YEL-VIO	J10-P4/5	50v DC	26-1200 090-5044-00T
#6	BANK CLOSE	Q6	I/O Pwr. Drvr.	BRN-BLU	J8-P7	YEL-VIO	J10-P4/5	50v DC	23-1100 090-5030-00T
#7	DROP TARGET RESET	Q7	I/O Pwr. Drvr.	BRN-VIO	J8-P8	YEL-VIO	J10-P4/5	50v DC	24-940 090-5036-00B
#8	LOCK KICKER	Q8	I/O Pwr. Drvr.	BRN-GRY	J8-P9	YEL-VIO	J10-P4/5	50v DC	23-800 090-5001-00B

High Current Coils Group 2		Drive Transistor (D.T.)	Driver Output Board	D.T. Control Line Color	D.T. Control Line Connect	Power Line Color	Power Line Connection	Power Voltage	Coil (GA-Turn) Part #
#9	UPPER LEFT POP	Q9	I/O Pwr. Drvr.	BLU-BRN	J9-P1	YEL-VIO	J10-P4/5	50v DC	26-1200 090-5044-00T
#10	UPPER RIGHT POP	Q10	I/O Pwr. Drvr.	BLU-RED	J9-P2	YEL-VIO	J10-P4/5	50v DC	26-1200 090-5044-00T
#11	UPPER BOTTOM POP	Q11	I/O Pwr. Drvr.	BLU-ORG	J9-P4	YEL-VIO	J10-P4/5	50v DC	26-1200 090-5044-00T
#12	CHANCE SCOOP	Q12	I/O Pwr. Drvr.	BLU-YEL	J9-P5	YEL-VIO	J10-P4/5	50v DC	23-800 090-5001-00B
#13	BANK OPEN	Q13	I/O Pwr. Drvr.	BLU-GRN	J9-P6	YEL-VIO	J10-P4/5	50v DC	23-1100 090-5030-00T
#14	UPPER FLIPPER (50v RED/YEL)	Q14	I/O Pwr. Drvr.	BLU-BLK	J9-P7	RED-YEL GRY-YEL	J10-P1/2	50v DC	23-1500 090-5062-00
#15	LEFT FLIPPER (50v RED/YEL)	Q15	I/O Pwr. Drvr.	ORG-GRY	J9-P8	RED-YEL GRY-YEL	J10-P1/2	50v DC	22-1080 090-5032-00T
#16	RIGHT FLIPPER (50v RED/YEL)	Q16	I/O Pwr. Drvr.	ORG-VIO	J9-P9	RED-YEL BLU-YEL	J10-P1/2	50v DC	22-1080 090-5032-00T

Low Current Coils Group 1		Drive Transistor (D.T.)	Driver Output Board	D.T. Control Line Color	D.T. Control Line Connect	Power Line Color	Power Line Connection	Power Voltage	Coil, Bulb or Meter Part #
#17	LEFT SLINGSHOT	Q17	I/O Pwr. Drvr.	VIO-BRN	J7-P2	BRN	J7-P1	20v DC	23-800 090-5001-00T
#18	RIGHT SLINGSHOT	Q18	I/O Pwr. Drvr.	VIO-RED	J7-P3	BRN	J7-P1	20v DC	23-800 090-5001-00T
#19	FLASH RGT RAMP TOP	Q19	I/O Pwr. Drvr.	VIO-ORG	J7-P4	ORG	J6-P10	20v DC	#906 Bulb 165-5004-00
#20	FLASH RGT RAMP MID (X2)	Q20	I/O Pwr. Drvr.	VIO-YEL	J7-P6	ORG	J6-P10	20v DC	#906 Bulb are ABOVE
#21	FLASH LEFT RAMP TOP (X2)	Q21	I/O Pwr. Drvr.	VIO-GRN	J7-P7	ORG	J6-P10	20v DC	#89 Bulb 165-5000-89
#22	FLASH LEFT RAMP MID (X2)	Q22	I/O Pwr. Drvr.	VIO-BLU	J7-P8	ORG	J6-P10	20v DC	#89 Bulb are BELOW
#23	FLASH LEFT RAMP BOT	Q23	I/O Pwr. Drvr.	VIO-BLK	J7-P9	ORG	J6-P10	20v DC	#906 Bulb 165-5004-00
#24	OPTIONAL COIN METER	Q24	I/O Pwr. Drvr.	VIO-GRY	J7-P10	RED	J16-P7	5v DC	Meter 5v 091-5000-00

Diode On Terminal Strip (if noted)

Low Current Coils Group 2		Drive Transistor (D.T.)	Driver Output Board	D.T. Control Line Color	D.T. Control Line Connect	Power Line Color	Power Line Connection	Power Voltage	Coil (GA-Turn) or Bulb Part #
#25	WATERWORKS MOTOR	Q25	I/O Pwr. Drvr.	BLK-BRN	J6-P1	BRN	J7-P1	20v DC	EX00159A 041-5083-00
#26	ELECTRIC COMPANY	Q26	I/O Pwr. Drvr.	BLK-RED	J6-P2	BRN	J7-P1	20v DC	23-800 090-5001-00T
#27	MOTOR RELAY	Q27	I/O Pwr. Drvr.	BLK-ORG	J6-P3	BRN	J7-P1	20v DC	DC Relay 520-5066-00
#28	DICE EJECT	Q28	I/O Pwr. Drvr.	BLK-YEL	J6-P4	BRN	J7-P1	20v DC	26-1200 090-5044-00T
#29	FLASH RGT RAMP BOT	Q29	I/O Pwr. Drvr.	BLK-GRN	J6-P5	ORG	J6-P10	20v DC	#906 Bulb 165-5004-00
#30	LEFT RAMP DIVERTER	Q30	I/O Pwr. Drvr.	BLK-BLU	J6-P6	BRN	J7-P1	20v DC	32-1800 090-5031-00
#31	RIGHT RAMP DIVERTER	Q31	I/O Pwr. Drvr.	BLK-VIO	J6-P7	BRN	J7-P1	20v DC	32-1800 090-5031-00
#32	TOP LANE UP/DN POST	Q32	I/O Pwr. Drvr.	BLK-GRY	J6-P8	BRN	J7-P1	20v DC	26-1200 090-5044-00T

Note: In Test Flash Lamps Menu ("Flash" Icon), Flashers tested are all Flash Lamps located between Q1-Q32 (This Game.)

Auxilliary (UK ONLY)		Drive Transistor (D.T.)	Driver Output Board	D.T. Control Line Color	D.T. Control Line Connect	Power Line Color	Power Line Connection	Power Voltage	Coil (GA-Turn) Part #
AUX 1: LEFT UP/DOWN POST	Q1	Sol. Expander (Aux. Board)		WHT	J3-P11	BRN	J7-P1	20v DC	26-1200 090-5044-00T
AUX 2: CENTER UP/DOWN POST	Q2	Sol. Expander (Aux. Board)		RED	J3-P10	BRN	J7-P1	20v DC	23-1100 090-5030-00T
AUX 3: RIGHT UP/DOWN POST	Q3	Sol. Expander (Aux. Board)		ORG	J3-P9	BRN	J7-P1	20v DC	26-1200 090-5044-00T



COIL LOCATIONS

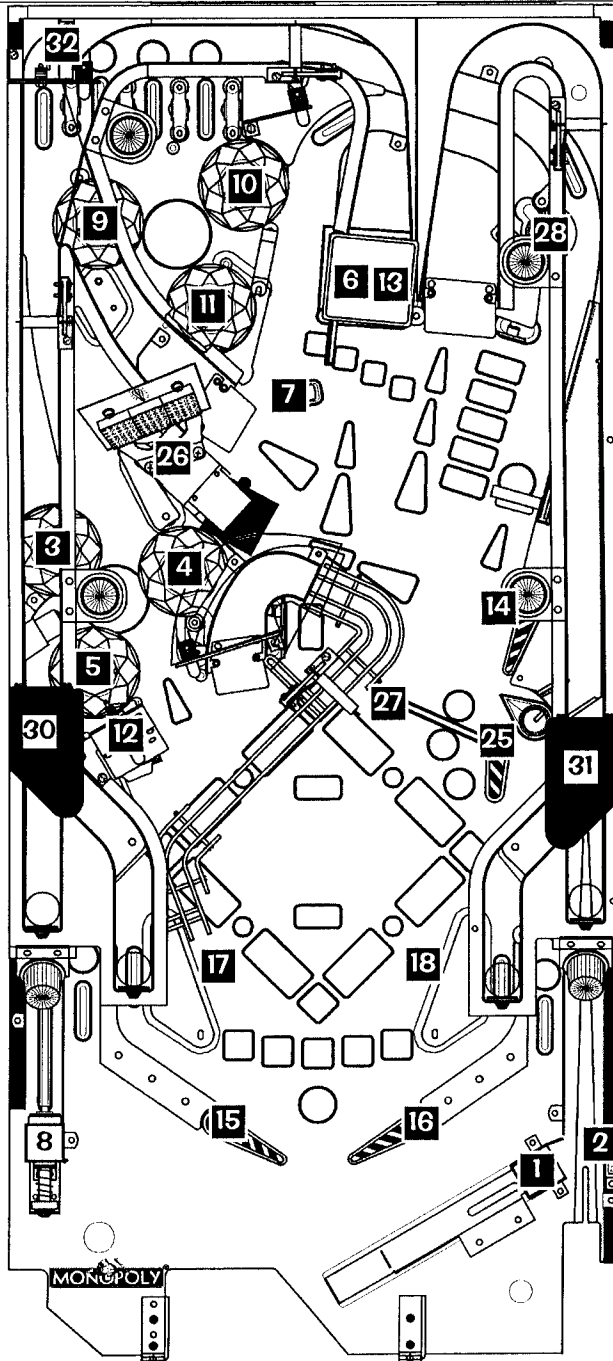

FLASH LAMP LOCATIONS

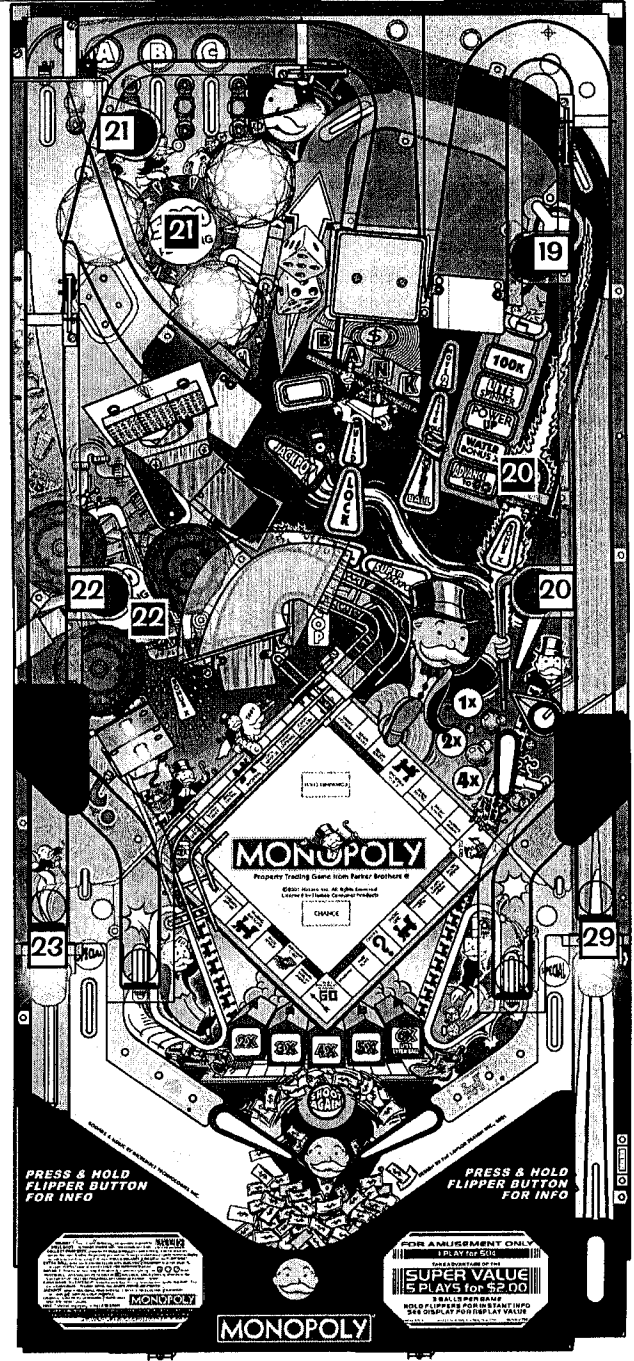

Legend Note: = Coils/Flashers mounted above P/F. = Coils/Flashers mounted below the P/F. = ...mounted in/on Cabinet.

TYPICAL COIL WIRING

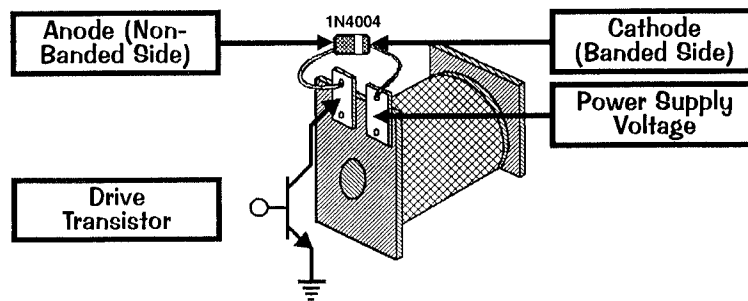

Note:
All Coils require diodes. Some diodes are located on Terminal Strips (under playfield) & not on the coil itself.

D iode
O n
T ermal
S trip



Dr. Pinball
Find-It-In-Front:



DR. 7

Domestic Pinball & Redemption Distributors Map

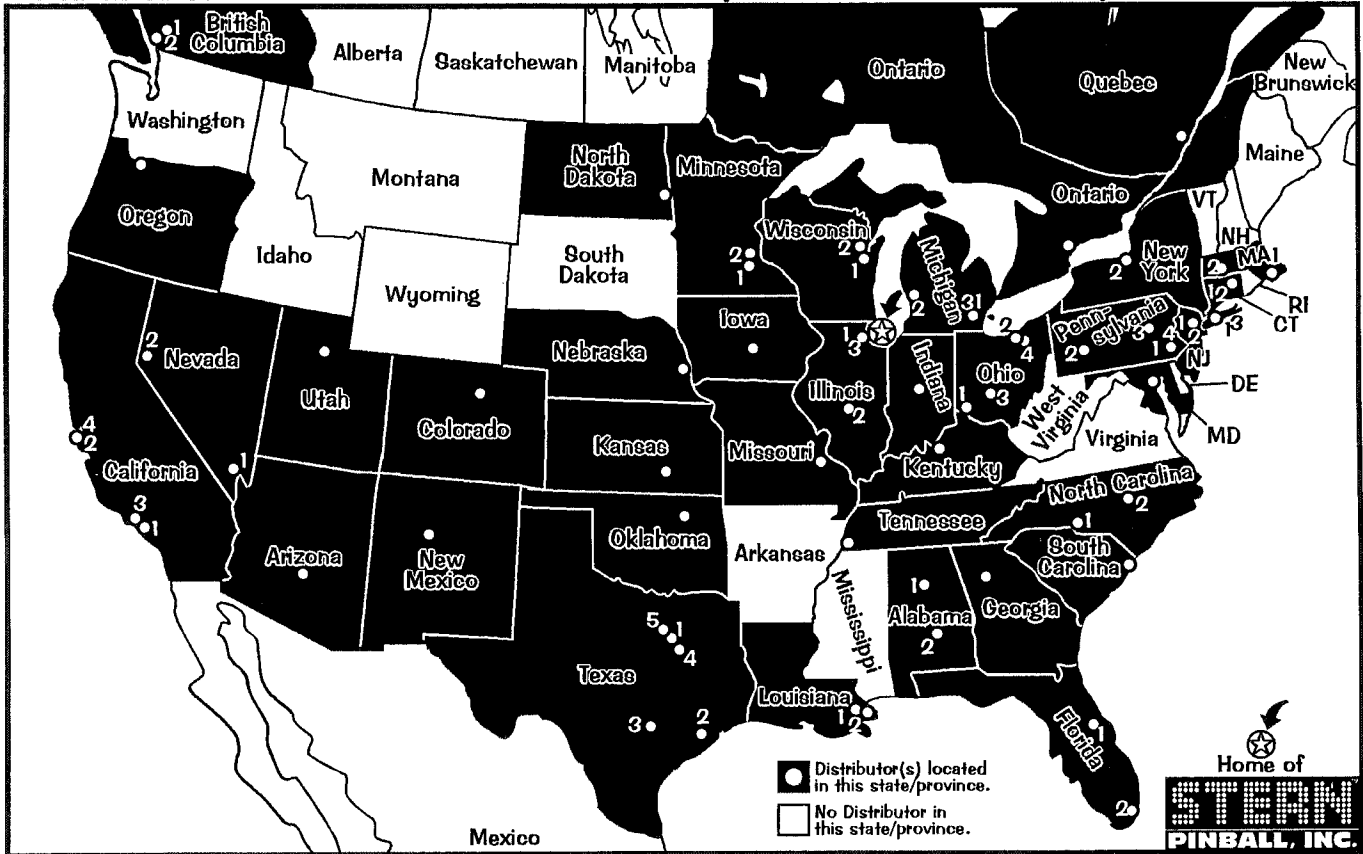

International Distributors Map

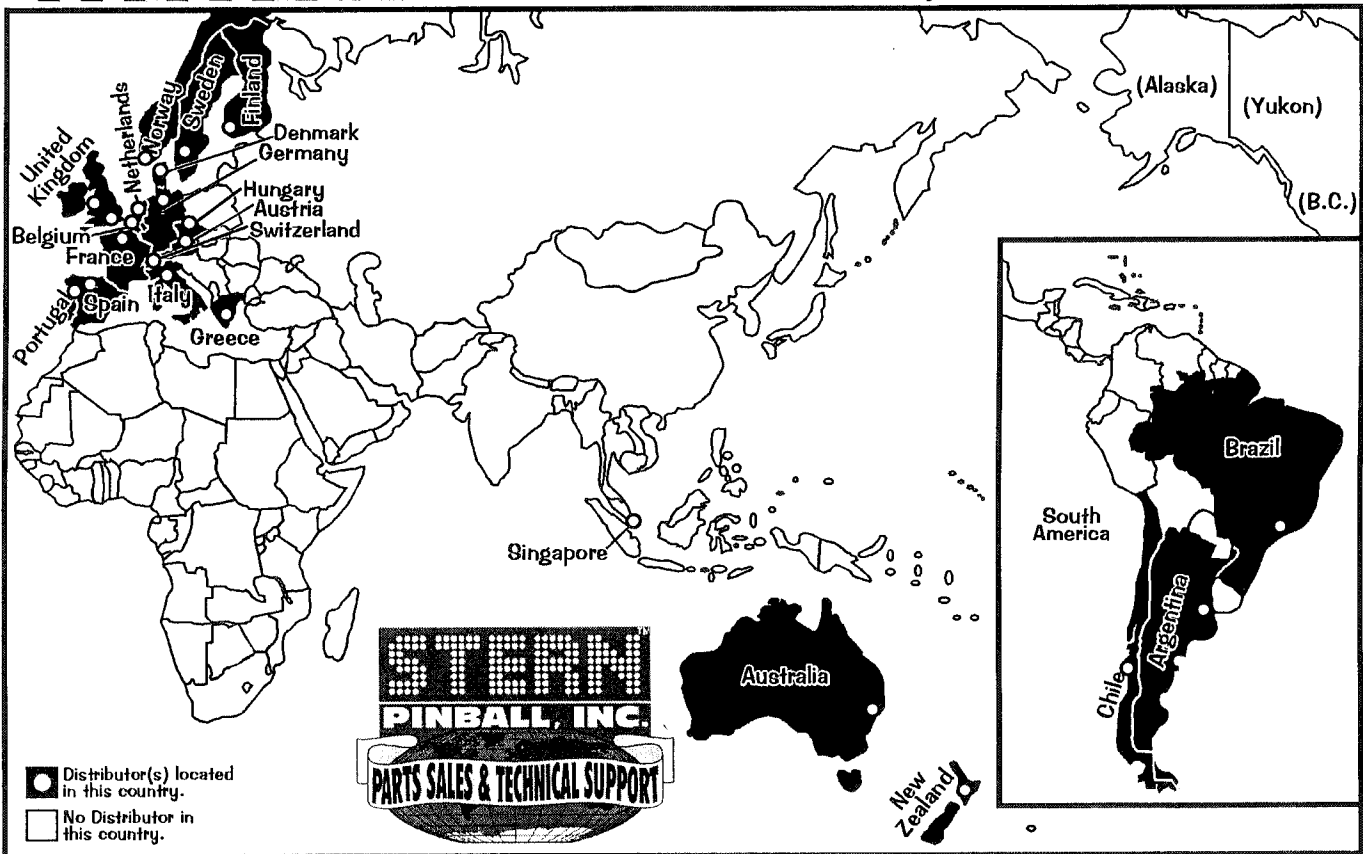

For Parts & Service, call your nearest Distributor. View the above maps and the directories on the next page to locate your closest Distributor in your state, province, or country. Distributors and phone numbers are subject to change. Call **Stern™ Pinball, Inc.** (Parts Sales & Technical Support) with any questions or if your Distributor cannot help you: 1-800-542-5377 (in USA or Canada) or 1-708-786-5466. Visit us at www.SternPinball.com for current Distributor information & other pinball needs.



Domestic Pinball & Redemption Distributors Directory

ALABAMA Birmingham Vending Birmingham (1) 1-205-324-7526 Franco Distributing Montgomery (2) 1-334-834-3455	IOWA Greater America Dist. Johnston 1-515-278-4455 Moss Distributing Des Moines 1-515-266-6422	MINNESOTA Hanson Distributing Bloomington (1) 1-612-884-6604 Lieberman Music Minneapolis (2) 1-612-887-5299	NORTH DAKOTA M.H. Associates, Inc. Fargo 1-701-282-7877	TENNESSEE Brady Distributing Memphis 1-901-345-7811 Green O.A.M.E.B. Memphis 1-901-353-1000	CANADA ONTARIO Starburst Coin Mach. Toronto 1-416-251-2122 Parts & Service Only: BRITISH COLUMBIA Can. Coin Machine Burnaby (1) 1-604-420-4008 Pacific Vending Vancouver (2) 1-604-324-2164 QUEBEC Laniel Automatic Mach. Montreal 1-514-731-8571
ARIZONA Mountain Coin Phoenix 1-602-269-7596	INDIANA Atlas Distributing Indianapolis 1-317-786-6892	MISSOURI Shaffer Distributing St. Louis 1-314-645-3393	OHIO Atlas Distributing Cincinnati (1) 1-513-851-4100 Cleveland Coin Cleveland (2) 1-216-692-0960	TEXAS Commercial Music Dallas (1) 1-214-741-6381	
CALIFORNIA Betson West Buena Park (1) 1-714-228-7500 So. San Francisco (2) 1-650-952-4220	Cleveland Coin Indianapolis 1-317-895-4270 Shaffer Distributing Indianapolis 1-317-899-2530	NEBRASKA Central Dist. Omaha 1-402-493-5600	Shaffer Distributing Columbus (3) 1-614-421-6800 Macedonia (4) 1-330-467-4850	H.A. Franz, & Co. Houston (2) 1-713-523-7366 San Antonio (3) 1-210-226-6322	
C.A. Robinson Los Angeles (3) 1-323-735-3001 San Francisco (4) 1-650-871-4280	KANSAS United Dist., Inc. Wichita 1-316-263-6181	Greater America Dist. Omaha 1-402-553-2812	OKLAHOMA Galaxy Distributing Tulsa 1-918-835-1166	Master Sales Corsicana (4) 1-903-874-4740	
COLORADO Mountain Coin Denver 1-303-427-2133	KENTUCKY Atlas Distributing Louisville 1-502-966-5266	NEVADA Mountain Coin Las Vegas (1) 1-702-798-0900	ONTARIO Starburst Coin Mach. Toronto 1-416-251-2122	Southgate Amusement Houston (2) 1-713-691-7335 San Antonio (3) 1-210-225-3844	
CONNECTICUT Betson Enterprises Milford (1) 1-203-878-6966	LOUISIANA AMA Distributors, Inc. Metairie (1) 1-504-835-3232	Reno Game Sales Reno (2) 1-775-829-2080	OREGON Dunis Distributing Portland 1-503-234-5491	Southgate/Moss Dist. Irving (5) 1-972-721-4600	
TDM Distributing Willimantic (2) 1-860-456-4231	New Orleans Novelty New Orleans (2) 1-504-888-3500	NEW JERSEY Betson Enterprises Carlstadt (1) 1-201-438-1300	Specialty Coin Products Portland 1-800-987-4946	UTAH Mountain Coin Salt Lake City 1-801-262-5494	
FLORIDA Birmingham Vending Orlando (1) 1-407-425-1505	MARYLAND State Sales & Service Baltimore 1-410-646-4100	State Sales & Service Carteret (2) 1-732-750-2700	PENNSYLVANIA Betson Enterprises King Of Prussia (1) 1-610-265-1155	Struve Distributing Salt Lake City 1-801-328-1636	
Brady Distributing Miami (2) 1-305-621-1415	Weiner Distributing Baltimore 1-410-525-2600	NEW MEXICO Mountain Coin Albuquerque 1-505-345-7706	Pittsburgh (2) 1-412-331-8703	Pioneer Sales & Svc. Green Bay (1) 1-920-336-5800	
Orlando (1) 1-407-872-1666	MASSACHUSETTS Betson Ent. (NECO) Norwood (1) 1-781-769-9760	Albuquerque 1-515-455-5400	Cleveland Coin Pittsburgh (2) 1-412-323-8400	Menomonee Falls (2) 1-262-781-1420	
GEORGIA Greater Southern Dist. Atlanta 1-404-352-3040	Gekay Sales E. Longmeadow (2) 1-413-525-2700	NEW YORK Betson Enterprises New Hyde Park (1) 1-516-354-4647	Green Coin Pittsburgh (2) 1-412-881-8804	Viking Vending Menomonee Falls (2) 1-262-255-6580	
ILLINOIS American Vending Elk Grove Village (1) 1-847-439-9400	MICHIGAN Atlas Distributing Redford (1) 1-313-794-4880	Deith Distributing Roslyn Heights (3) 1-516-621-1234	Roth Novelty (Superior) Wilkes-Barre (3) 1-570-824-9994		
Springfield (2) 1-217-492-9400	Wyoming (2) 1-616-241-1472	NORTH CAROLINA Brady Distributing Charlotte (1) 1-704-357-6284	State Sales & Service Bensalem (4) 1-215-638-1122		
Atlas Distributing Elk Grove Village (3) 1-847-952-7500	Cleveland Coin Livonia (3) 1-734-432-1040	Operators Distributing Archdale (2) 1-336-884-5714	SOUTH CAROLINA Green Coin Myrtle Beach 1-843-626-1900		

Note: For states and Canadian Provinces which do not have Distributors, call the neighboring state or province with the city closest to you (indicated with a white dot). States or Provinces with more than 1 city containing a distributor are numbered. View the map on the previous page.

Note: Distributors are subject to change. Visit us at www.SternPinball.com for current Distributor Information.

International Distributors Directory

ARGENTINA Universe Electronics Buenos Aires (54) 1865-4730	BELGIUM Brabo Antwerpen (32) 3238-9970	FINLAND Pelika Ray-Oy Espoo (0) 3589-2904-5299	GREECE Greece Coin Athens (30) 1577-7012	PORTUGAL Jacinto & Martins, Lda. Amadora (35) 12-1496-3744	SWITZERLAND Novomat, A.G. Harkingn (41) 6-2388-8961
Electroport (Florenca) Mar Del Plata (54) 22-3495-5532	BRAZIL DiverBras São Paulo (55) 11-6674-1000	FRANCE Avranches Automatic Ducey (33) 2-3389-6162	ITALY (RSM) Tecnoplay S.A. San Marino (39) 549-900361	SINGAPORE Valibel Technologies Singapore (65) 748-8404	UNITED KINGDOM Electrocoin London, England (44) 20-8965-2055
BRAZIL DiverBras São Paulo (55) 11-6674-1000	CHILE Cuinsa Santiago (56) 2641-8520	SFA Paris (33) 1-5326-8082	NEW ZEALAND Amco Machine Supplies Auckland (64) 9846-7606	SPAIN Commercial Cocomatic Madrid (34) 91-671-69-80	Electrocoin Aftersales Cardiff, S. Wales (44) 29-2034-3888
AUSTRALIA Amusement Mach. Dist. Matraville (61) 2-9316-6000	DENMARK Vendomatic (Oslo, Norway) (47) 2291-8383	GERMANY Nova Games Hamburg (49) 4053-8060	NORWAY Vendomatic Oslo (47) 2291-8383	SWEDEN Call for Information or visit our website www.SternPinball.com	
AUSTRIA R. Rupp Kaindorf (43) 3-4528-6105		GREECE Elcoin Nikea (30) 1492-9357			



**Dr. Pinball
Find-It-In-Front:**



POWER REQUIREMENTS

! This game *must be connected to a properly grounded outlet to reduce shock hazard* & insure proper game operation. See Sec. 5, Schematics & Troubleshooting, Chp. 3, Cabinet Wiring (Transformer Power Wiring), for transformer connections required for **Normal, High, and Low Line** conditions. **!**

Normal Line:		110v AC - 125v AC @ 60Hz	
Domestic uses an 8AMP 250v Slo-Blo Fuse.	AVG OPERATION	MAX OPERATION	
	CURRENT: 2.8AMP WATTAGE: 329w	CURRENT: 8AMP WATTAGE: 940w	
High Line:		218v AC - 240v AC @ 50Hz	
Export uses 5AMP 250v Slo-Blo Fuses. (*England & Hong Kong use an 8AMP 250v S/B Fuse.)	AVG OPERATION	MAX OPERATION	
	CURRENT: 1.8AMP WATTAGE: 412w	CURRENT: 5AMP 8AMP* WATTAGE: 1145w 1832w*	<small>England & Hong Kong use an 8A Fuse.</small>
Low Line:		95v AC - 108v AC @ 50Hz / 60Hz	
Export Japan Only uses an 8AMP 250v Slo-Blo Fuse.	AVG OPERATION	MAX OPERATION	
	CURRENT: 2.6AMP WATTAGE: 264w	CURRENT: 8AMP WATTAGE: 812w	

TRANSPORTATION

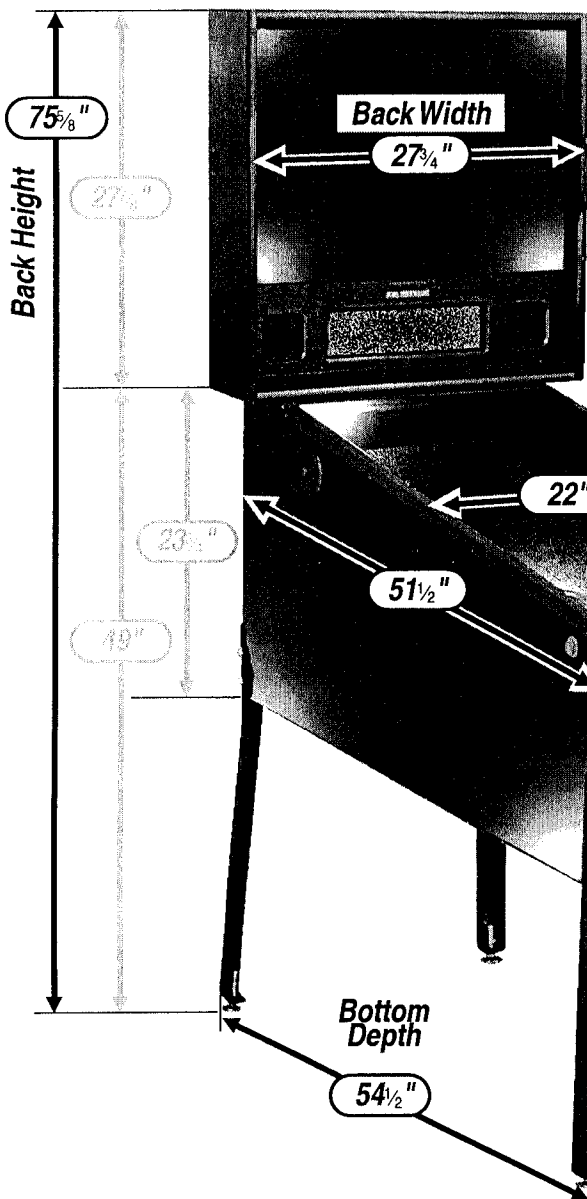

BEFORE TRANSPORTING



To reduce the possibility of damage, observe **ALL** precautions whenever transporting the game. **Read & follow Section 1, Chapter 1, Pinball Game Set-Up Procedures, & How to Secure the Backbox for Transporting.** Remove the legs & secure the game within the transporting vehicle.

Save and retain all printed information on the game.

The overall **Front** (36") & **Back** (85 1/2") dimensions reflect the **ADDED +1 1/4"** height with the **Leg Levelers** turned all the way in and includes the **OPTIONAL TOURNAMENT HEADER**;

The Cabinet is **designed to give the recommended 6.5° pitch to the Playfield** when all four (4) **Legs** are installed with the **Leg Levelers** turned all the way in.

With the **Leg Levelers** turned all the way out, an additional 1 1/4" **MORE** to the overall height should be added to the dimensions.

Shipping Box Dimensions

Height: 56"
Width: 31"
Depth: 31"

Approximate Unboxed Weight:
Wt. 260lbs. (+/- 10)

CAUTION

At least 2 people are required to move and maneuver this game. Use proper moving equipment & extreme care while handling!

GAME DIMENSIONS





Pinball Game Service Manual General Table of Contents
See Sections 3 & 5, Table Of Contents, for details of that Section and it's Chapters.

Drop Target Replacement Procedure.....Inside Front

- ▶ Backbox Layout Locations: Fuses, Bridges, Relays & ROMs DR. ①
- ▶ Find-It-In-Front: Dr. Pinball Section Explained..... DR. ②
- ▶ Diagnostic Aids ↪ CPU DIP Switch Settings ↪ ROM Summary Table..... DR. ③
- ▶ Switch Matrix Grid & Dedicated Switches ↪ Lamp Matrix Grid DR. ④
- ▶ Switch & Lamp Matrix Grid Locations ↪ Typical Switch, Dedicated Switch & Lamp Schematics DR. ⑤
- ▶ Coils Detailed Chart Table DR. ⑥
- ▶ Coil & Flash Lamp Locations ↪ Typical Coil Wiring DR. ⑦
- ▶ Domestic Pinball & Redemption and International Distributors Maps..... DR. ⑧
- ▶ Domestic Pinball & Redemption and International Distributors Directories DR. ⑨
- ▶ Power Requirements ↪ Transportation ↪ Game Dimensions DR. ⑩

Game Manual General Table of Contentsi-ii

SECTION 11-4

- Chapter 1, After Set-Up..... 1
- ▷ Pinball Game Set-Up Procedures.....1
- ▷ Pinball Game Set-Up Future Reference.....2-3
- ▷ How to Secure the Backbox for Transporting ↪ Leg Leveler Adjustment ↪ Easy Access Service System - 3 Positions..... 4

SECTION 25-6

- Chapter 1, Game Operation & Features 5
- ▷ Start of Game Features ↪ During Game Features ↪ End of Game Features ↪ Auto Percentaging ↪ Instruction Card..... 6

SECTION 3 7-48

- Chapter 1, Portals™ Service Menu Introduction..... 7
- ▷ Portals™ Service Menu Table of Contents (View for an outline of this section) 7
- ▷ Portals™ Service Switch Set Access & Use ↪ How to Use This Section 8-9
- ▷ Portals™ Service Menu Icon Tree10-11
- ▷ Portals™ Service Menu Example ↪ Exiting the Portals™ Service Menu12-14
- Chapter 2, Go To Diagnostics Menu 15-27
- Chapter 3, Go To Audits Menu 28-33
- Chapter 4, Go To Adjustments Menu..... 34-42
- Chapter 5, Go To Reset Menu 43-44
- Chapter 6, Go To Fuse Table 45-46
- Chapter 7, Go To Help Screen 47-48

SECTION 4 49-80

- Chapter 1, Parts Identification & Location (The Pink Pages) 49
- Overview.....49
- MONOPOLY® Backbox Assembly 50
- Speaker Panel Assy. for the Backbox & Associated Parts:..... 51
- Cabinet - General Parts & Switches52-53
- Playfield - General Parts & Switches (Below) 54
- Playfield - General Parts & Switches (Above) 55

Section 4, Chapter 1, Parts Identification & Location (The Pink Pages) Continued on the Next Page



Playfield - Rubber Parts (Rings Actual Size) 56
 Playfield - Plastics (Screened & Clear) & Decals 57
 Playfield - Rails, Wire Forms, Ball Guides and Flat Metal Ramps 58
 Playfield - Metal Posts (Screws) and Nuts (Actual Size) 59
 Playfield - Metal Spacers (Actual Size) 60
 Playfield - Plastic Posts and Spacers (Actual Size) 61
 Playfield - Small Bayonet Type Bulbs and Sockets (Actual Size) 62
 Playfield - Large Bayonet Type Bulb and Sockets (Actual Size) 63
 Playfield - Wedge Base Bulbs and Sockets (Actual Size) 64
 Chapter 2, Drawings for Major Assemblies & Ramps (The Blue Pages) 65
 ▷ Overview 65
 Ball Shooter (Plunger) Assembly, 500-6146-00-04 (Top) 66
 Autoplunger Coil Assembly, 500-6092-05 with Arm Weld Assembly, 500-6091-00 (Bot) 66
 4-Ball Trough Assembly, 500-6318-14 and Associated Parts: 67
 Flipper (Left) Assembly, 500-5944-12 and Associated Parts: 68
 Flipper (Right) Assembly, 500-5944-02 and Associated Parts: 69
 Flipper (Upper) Assembly, 500-5944-35 and Associated Parts: 70
 Turbo (Pop) Bumper Top Assy., 515-6459-01 (Qty. 6) (Top) 71
 Turbo (Pop) Bumper Bottom Assy., 515-6459-04 (Qty. 6) (Mid) 71
 Turbo (Pop) Bumper Switch Assy., 515-6459-03 (Qty. 6) and Associated Parts: (Bot) 71
 Slingshot Assemblies, 500-5849-00 (Qty. 2) (Top) 72
 Kick Big (Laser Kick) Assembly, 500-5862-02 (Bot) 72
 30° Eject Assembly, 500-6511-00 (Top) 73
 30° Eject Assembly, 500-6511-01 (Bot) 73
 Ball Deflector Assembly, 500-6433-00 74
 Scoop [Kicker] Assembly, 500-6491-00 75
 1-Bank Drop Target Assembly, 500-6440-21 76-76
 MONOPOLY® Bank Assembly, 500-6512-00 78-79
 Mini-Flipper & Motor Assembly, 500-6486-00 80-81
 Left Plastic Ramp & Individual Parts 82-83
 Right Plastic Ramp & Individual Parts 84-85
 Metal Ramp, Wire Ramp & Individual Parts 86
 Speed Bumper Ramp & Individual Parts 87
 ▷ UK ONLY OPTIONAL: Ball Deflector Assemblies, 500-5764-02 (Qty. 2) (Top) 88
 ▷ UK ONLY OPTIONAL: Up/Down Post Assembly, 500-6293-00 (Bot) 88

SECTION 5 89-138

▷ Schematics & Troubleshooting Table of Contents (outline of this section) 89
 Chapter 1, Backbox Wiring (The Yellow Pages) 91-92
 Chapter 2, Playfield Wiring (The Yellow Pages) 93-96
 Chapter 3, Cabinet Wiring (The Yellow Pages) 97-98
 Chapter 4, Printed Circuit Boards (PCBs) (The Yellow Pages) 99-134

APPENDIXES A-I A1-A16

▷ Appendixes A-I Table of Contents (outline of this section) A1
 ▷ Appendixes A-I A2-A14
 Plastic Part Color Chart (Bottom) A13 + (Top) A14
 Glossary of Terms & Parts Order Checklist Notes A15-A16

Limited Warranty, Cautions, Warnings & Notices Inside Back



After Set-Up

Pinball Game Set-Up Procedures

...after reading the Pinball Game Set-Up Instruction Sheet (SPI Part № 755-5310-00) included with your New Pinball Game, continue with the below procedures:

With the Back Glass Removed:

1. Check all connectors in the Backbox for loose wire terminations. Reseat any loose wire by pushing in on the terminal. **Push on all connectors plugged into the CPU/Sound Board, I/O Power Driver Board, and the Display Power Bd.** to check that they are properly seated. Ensure Fluorescent Light Tube is seated correctly. Check that all fuses are seated properly. **Close and lock the Backbox and secure its' keys back inside the Coin Door.**

With the Playfield Glass Removed:

2. Make sure the proper amount of pinballs were installed (*Amount of balls are always specified on decal attached to the lock down assembly and top of Page DR. 3 in the beginning of this manual*).

3. Remove all shipping tie downs, shipping blocks, packing foam, shipping instruction pages, etc. (if any) from the game. **READ ALL PRINTED INFORMATION!** Shipping instructions, labels and/or decals describe warnings, cautions, and/or important information specific to the game. **SAVE ALL PRINTED INFORMATION.**

4. Raise the playfield and support it, by lifting the **Prop Rod** (*located on the left, inside the cabinet*). The end of the Prop Rod should be placed into the hole under playfield. See the illustration "Easy Access Service System" on Page 4.

5. Visually inspect all cabinet cables and connector terminations; ensure no wires or cables are pinched and that cable harnesses are not pulled tight.

6. Lower the playfield and ensure game is **level side-to-side** by adjusting Leg Levelers, if required. See the illustration "Leg Leveler Adjustment" on Page 4. With the Leg Levelers turned all the way in (1.25" from floor to bottom of leg), the game pitch is 6.5°; depending on the condition of the floor, adjust the Leg Levelers as required.

USE THE BUBBLE LEVEL ON THE WOOD RAIL (LOWER RIGHT) TO DETERMINE IF LEVEL IS ACHIEVED. BUBBLE SHOULD APPEAR BETWEEN THE 2 BLACK LINES. SEE PAGE 4 FOR AN ILLUSTRATION.

The playfield incline affects difficulty of play. Use the recommended incline; Game difficulty is best varied using game adjustments.

With the Coin Door Open:

7. If desired, perform any self tests at this time. See **Section 3, Chapter 1, Portals™ Service Menu Introduction, and Chapter 2, Go To Diagnostics Menu**, for instructions on how to enter "Begin Play Test" and "Game Specific" to test components on the game.

8. If desired, make **Game Pricing (Standard and/or Custom)** and **Add-A-Ball, Novelty, or X-Ball Play** adjustments at this time. See **Section 3, Chapter 4, Go To Adjustments Menu**, for instructions on how to enter adjustments. Follow instructions in the tables provided in the manual for suggestions of customizing.

PINBALL GAME SET-UP

CAUTION: At least 2 people are required to move and maneuver game. Use proper moving equipment & extreme care while handling. Pinball game is 260lbs (wt. 10). Refer to Game Manual for further Game Set-Up Procedures (Sec. 1, Crp. 1) and other important information!

TOOLS REQUIRED: 5/8" Socket Wrench & Utility Knife

NOTE: KEYS are used for the Shooter Rod (if equipped) and used to the Playfield Glass or Playfield with Auto Plunger Button. Remove keys. One key set stops the rest of the cabinet to gain access to the White Star Board System.

ALWAYS STORE THE MANUAL & INFORMATION SHEETS INSIDE THE CABINET WHEN NOT USING.

© 2000 Stern®/Midwest, Inc. SPI Part № 755-5310-00

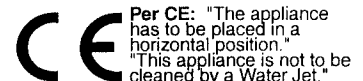

Pinball Game Set-Up Future Reference

CAUTION: At least 2 people are required to move and maneuver game.

Use proper moving equipment & extreme care while handling. Pinball game is 260lbs (+/- 10).

Refer to Game Manual for further Game Set-Up Procedures (Sec. 1, Chp. 1) and other important information!

TOOLS REQUIRED: 5/8" Socket Wrench & Utility Knife

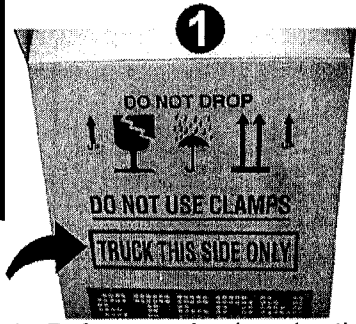

1. Before opening box, lay the box flat on its side with "TRUCK THIS SIDE ONLY" facing the floor.

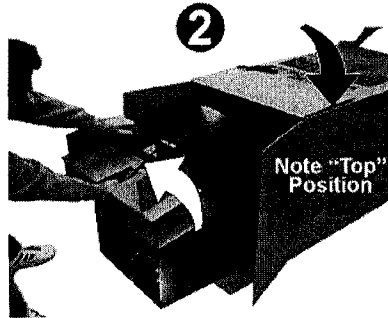

2. Slide game out using the Black Nylon Strapping as a handle.

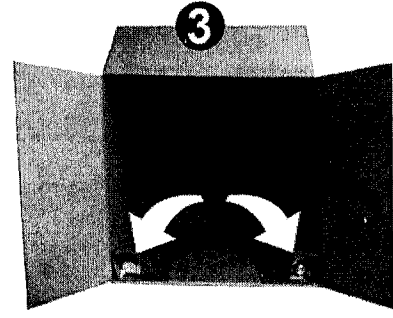

3. Remove the Four (4) Identical Legs with Levelers from the carton and set aside. (**SAVE!** all packing materials and information sheets related to this pinball until Set-Up is complete.)

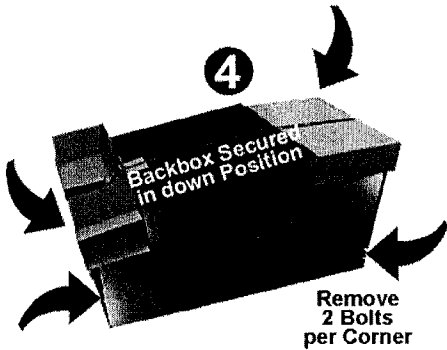

4. At this point **DO NOT CUT STRAPPING** (You want to keep the Backbox secured in the down position). Loosen and remove the 8 Leg Bolts (use 5/8" Socket Wrench) and set aside.

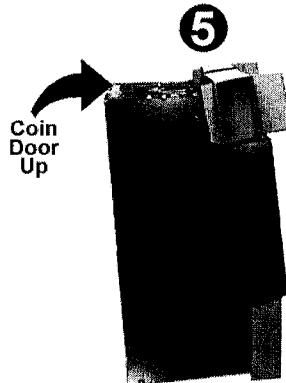

5. Lift game into an **UPRIGHT POSITION** (Coin Door Facing Up).

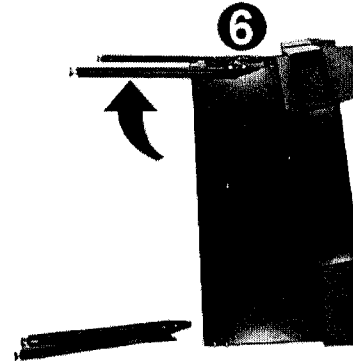

6. Install **FRONT LEGS** using the bolts removed from **Step 4**. Secure tightly. Take care not to scratch the Black Finish on any of the Legs.

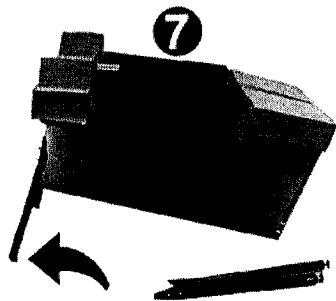

7. Carefully set the game down on the **FRONT LEGS**. Care should be taken... Game is heavy, two (2) people are recommended for this and the following step.



8. Using supports or two (2) people, prop the rear of the cabinet up and install **REAR LEGS**. Secure tightly.



9. Cut **BLACK NYLON STRAPPING**. **CAUTION:** Strapping will **SNAP**, protect your eyes! Use extreme care when using a utility knife or scissors.

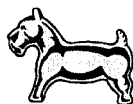

Pinball Game Set-Up Future Reference Continued

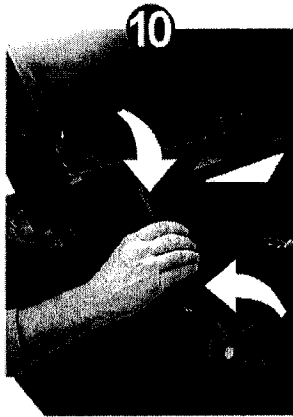

10. Lift the Backbox into the UPRIGHT POSITION (Ensure the cables do not get pinched).



11. After the BACKBOX is in the UPRIGHT POSITION, locate the 5/16" HEX KEY. While inserted, rotate KEY with a 3/4 turn until latched & locked.

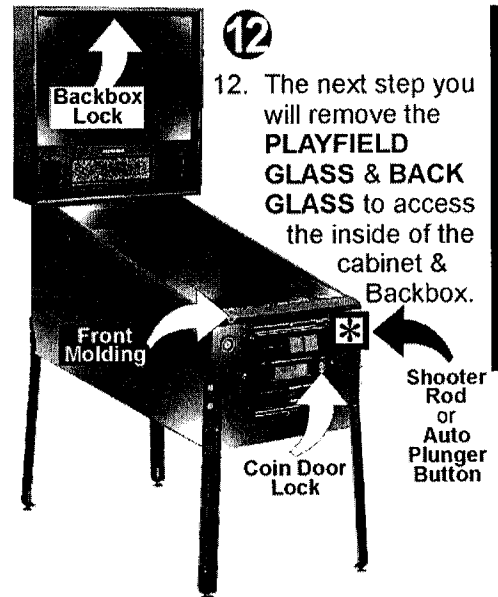

12. The next step you will remove the PLAYFIELD GLASS & BACK GLASS to access the inside of the cabinet & Backbox.

NOTE: KEYS are tied to the Shooter Rod* (if equipped) or taped to the Playfield Glass (if equipped with Auto Plunger Button). Remove keys. One (1) set of keys opens the Coin Door, the other set is used to unlock the Back Glass to gain access to the White Star Board System.

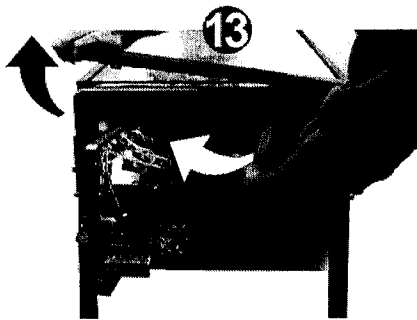

13. Open the Coin Door and pull the YELLOW HANDLE to the LEFT and at the same time pull up on the FRONT TOP MOLDING and remove. The GLASS can now be pulled out towards you and removed. TAKE CARE while moving; set glass on a safe surface.

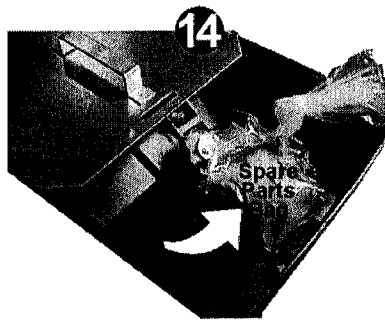

14. Through the open Coin Door, remove the RETAINING RING at the rear of the CASH BOX and open. Remove the PINBALLS & the PLUMB BOB from the SPARE PARTS BAG. (Save the other spare parts in cabinet). Install the PINBALLS by placing them on the playfield so they can roll into the Outhole Ball Trough.

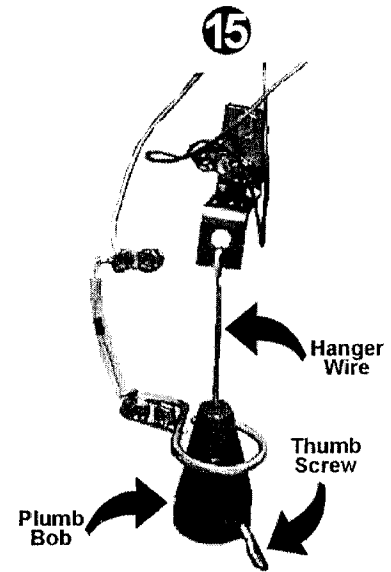

15. Install the PLUMB BOB on the Hanger Wire & tighten the Thumb Screw. Loosening the Thumb Screw & lowering or raising the PLUMB BOB makes the Games Tilt Function more or less sensitive.

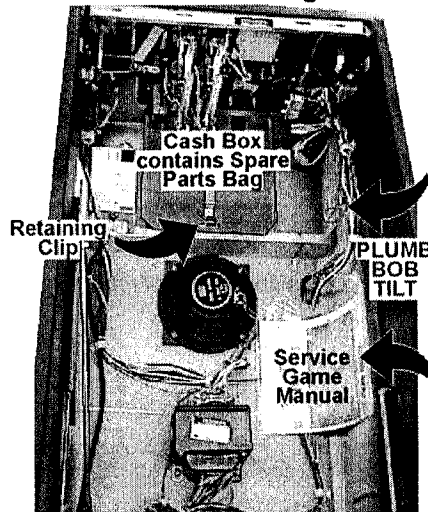
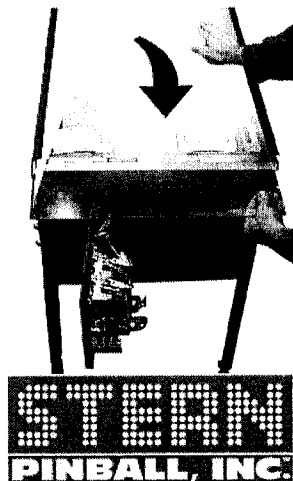

Remove the PINBALL GAME MANUAL (stapled to side of the left wall of the cabinet). Review Section 1, Chapter 1, which describes how to lift the playfield to access the Plumb Bob Tilt Assembly. The manual gives you all the important information you need to prepare for final set-up and other important information (such as Parts, Diagnostics, Schematics and more...).

ALWAYS STORE THE MANUAL & INFORMATION SHEETS INSIDE THE CABINET WHEN NOT USING.

How to Secure the Backbox for Transporting

Sec. 1: After Set-Up

For more Backbox details & part numbers, see Section 4, Chapter 1, Backbox Assembly, Pages 50-51.

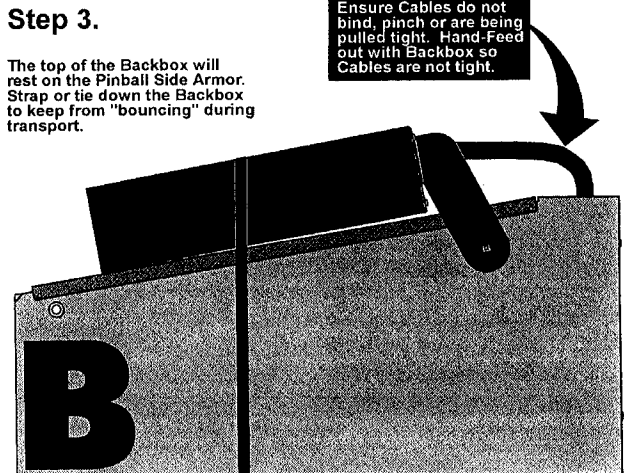
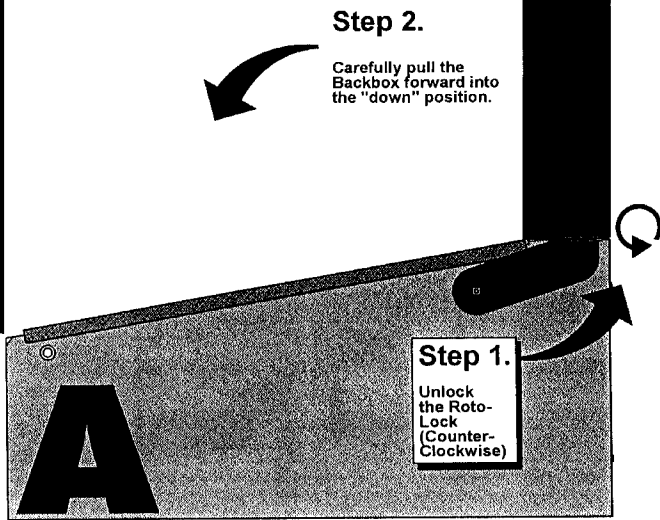

Leg Leveler Adjustment

On a LEVEL FLOOR, this cabinet is designed to automatically have a 6.5° pitch without adjusting levelers.

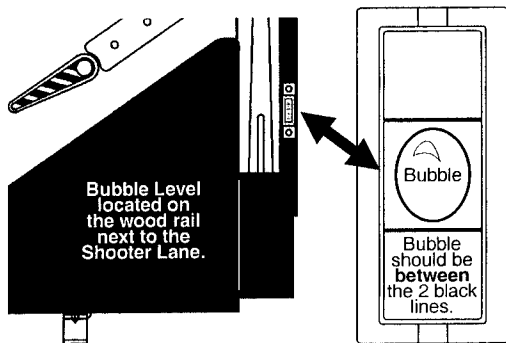

Attach the four (4) Leg Assemblies to cabinet corners with the eight (8) leg bolts provided (See Sec. 4, Chp. 1, Cabinet - General Parts & Switches, Page 52).

Start adjustment with the leg levelers turned all the way in. View the bubble in the level provided on the right side wood rail. Adjust the front or rear levelers as necessary to cause the bubble to float between the two (2) black lines. Use a pinball to roll down the center of the playfield for side-to-side leveling.

YOUR PLAYFIELD PITCH IS NOW AT 6.5° AS REQUIRED FOR PROPER GAME PLAY!

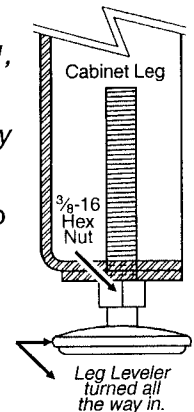

For custom adjustment greater than >6.5° can be achieved by turning out the rear leg leveler(s), however, it is not recommended.

Easy Access Service System - 3 Positions

With the front molding & glass removed, carefully lift the playfield (take care when using the Bottom Arch to hoist).

Positions 1 & 2

When lifted high enough, the **Playfield Support Slide Brackets** (Fig. 1A) can be seen & can clear the cabinet front. At this time, pull the playfield toward the front of the cabinet, checking that the mechanical components clear the cabinet front, then rest the playfield on the **Playfield Support Slide Brackets** at the front channel of cabinet (Fig. 1C); Or, the **Prop Rod** (located on the right inside of cabinet) can be used by positioning the **Prop Rod** end into the receiving playfield hole (Fig. 1B).

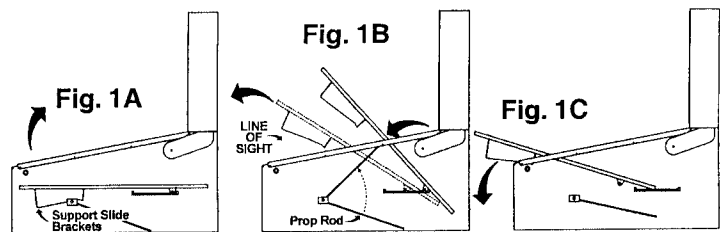

Position 3

With the playfield at rest, hold the sides & pull toward the front of the cabinet (approx. 6" to 8"), until resistance is felt from **Edge Slide Brackets** stopping against the **Slide & Pivot Support Brackets** located on either side of the cabinet (Fig. 2A). At this time, swivel the playfield toward the Backbox, then rest on the top edge (Fig. 2B & 2C).

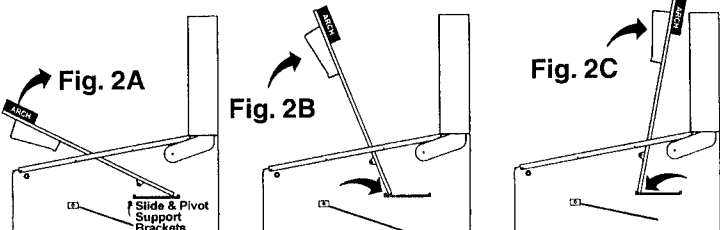

Game Operation & Features

Start of Game Features

Starting a Normal Game

Insert coin(s). The game generates a sound for the first coin & for each subsequent coin with the display indicating the number of credits posted. Press the **Start Button** and a start-up sound is produced, and the posted credits are reduced by one. Subsequent players can be added (**up to 4 can play!**) by pressing the **Start Button** before the end of ball 1 (with sufficient credit in the game).

The display now indicates the player or # of players selected from the total depressions of the **Start Button**. The display indicates the ball in play, and a ball is served to the *Shooter Lane*. An introduction is shown followed by Skill Shot Graphics and/or instructions. Pressing the **Start Button** after ball 1 of any player will start a new game (if credits are available), **but only** if the **Start Button** is depressed for 2-3 seconds. This delay is to avoid accidental "re-starts" of a game. (*Note: Any partial credit remaining during game play after the end of ball 1, or power down, will be eliminated.*)

Starting Team Play (Doubles!)

Team Play is a four player game. The totals for players 1 & 3 (Team 1) and players 2 & 4 (Team 2) are displayed individually as well as the combined score for both teams. Team Play only works in a 4-Player game. In all other cases, the individual scores are shown.

Starting League Play

After credit is posted, while holding in the **Left Flipper Button**, press the **Start Button**. League Play has now begun. The differences between Normal Game Play and League/Tournament Play are: There is no "auto-percentaging" (awarding extra balls, specials, etc. to players with very low scores on the second or third ball). Mystery Features are awarded in a set order rather than random in Normal Game Play. Percentage Game Features are not automatically advanced as they are for the Regular Play Features.

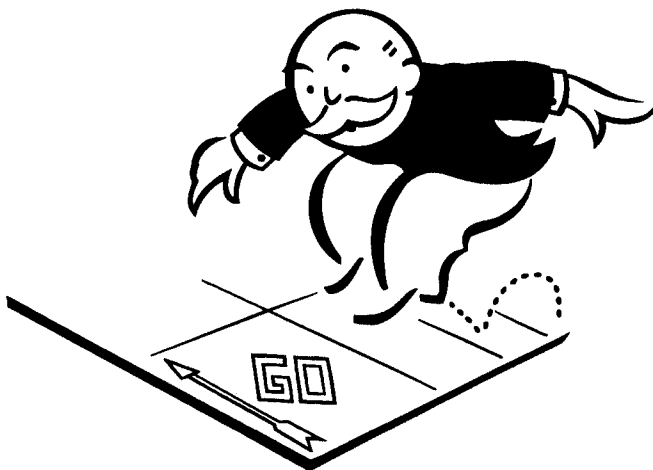

During Game Features

Feature Mode & Combination Shots

Features are lit on the playfield and started by completing *certain shots* (e.g. completion of Target Banks, Orbit(s), Ramp(s) and/or any combination of the shots).

Multiball

Multiball is started after completion of certain features. Multiball may vary with the amount of balls used depending on game style.

Replay Feature

Replay awards are given as the player exceeds a High Score Level during game play. This can be adjusted with **Adj. 3, Replay Awards** (Default = **CREDIT**). Players exceeding the High Score Levels can receive: **CREDIT, EXTRA BALL, or SPECIAL**. Adjust to **NONE** if a replay award is not desired.

End of Game Features

Game Endings

When all player(s) have played all balls (including any Extra Balls), the game ends. If power is interrupted during the course of a game, it will end that game (**see Starting a Normal Game**). Closure of the Plumb Bob Tilt Switch according to the number of tilts set, **Adj. 13, Tilt Warnings** (Default = 1) or prolonged closure, will end the current Ball-In-Play. Closure of the Slam Tilt Switch on the Coin Door ends the current game(s).

Match Feature

At the end of each ball, earned bonuses are collected. At the end of the last ball of a game (including any extra balls, if applicable), earned bonuses are collected, then the system produces a random 2-digit number (a multiple of 10; 00 to 90). Matching the last 2 digits of the player's score with this number awards a credit. In **Adj. 11, Match Percentage** (Default = 8%) can be changed from 0-10%. Changing the percentage to **0%** displays the "Match Animation" at the end of the game, however, will never match nor award anything. Changing this adjustment to **OFF** will not display the "Match Animation" nor award anything.

Entering Initials/Name

If player achieved a new high score in a game or achieved a special feature (if given) the player may enter 3 Initials. In **Adj. 32, High Score Initials** (Default = **3 Initials**) can also be changed to **10-Letter Name**. Use the **Flipper Buttons** to choose a letter or character as seen on the Dot Display. Hitting the **Start Button** locks in the letter or character and proceeds to the next letter. The game then proceeds into the *Game-Over Mode* and then to the *Attract Mode*.

Note: Adj. 34, Custom Message (Default = **ON**) can be displayed during the *Attract Mode*; enter letters in the same fashion.

For more details with Adjustments, see Sec. 3, Chp. 4.

Continued Next Page.

Auto Percentaging

This game is equipped with Auto Percentaging, **Adjustment 1, Replays: Fixed/Auto** (Default = 12%, adjustable). The *Replay Percent* is automatically adjusted or you can set a *Fixed Replay Score*. Four levels may be selected. Adjustments allow awarding of a "CREDIT" (or your setting) as each level is exceeded. This can be adjusted with, **Adj. 3, Replay Award** (Default = Credit). With the **Autopercentage Feature**, if the actual replay percentage is higher or lower than that desired, the game will automatically adjust for the new recommended percentage score(s). You may choose to make a different "score-to-beat" adjustment; this is done by utilizing **Adj. 2, Replay Levels**. For more details with Adjustments, see Section 3, Chapter 4, Go To Adjustments Menu.

Instruction Card

Below is a **COPY** of the Game Instruction Card (SPI N°: 755-5175-00 USA) which is included with every game. If your card is lost or damaged, simply **COPY** this page and *cut out* the Instruction Card as a *temporary replacement* until a new card is ordered.

(Hint: **COPY & CUT** along the dotted line and fold in the center to keep the "COPY" sturdy.)

COPY & CUT



For more detailed game rules, visit our website @ www.SternPinball.com and click on the "MONOPOLY®" or "Game Archive" Pop Bumper Link.

FOLD HERE

OBJECT: *Own it all!* Collect as much property as possible.

SKILL SHOT: The **WATER WORKS** hole collects Skill Shot.

COLLECT PROPERTY: Shoot for the **ROLL & COLLECT** area when lit. This will move you around the board & collect the property you land on. When you collect any property watch the display for instructions on how to play that mode. **ROLL & COLLECT IS RE-LIT** on the **RIGHT RAMP**.

EXTRA BALL: Extra Ball is awarded by getting the **ELECTRIC COMPANY** to a high power %. The upper **POPS (Bumpers)** raise the **ELECTRIC COMPANY'S** power.

BONUS X: Awarded on outer loop shots when lit, or when completing the **A B C** lanes.

MULTIBALL: Advancing around the board to **GO** lites **LOCK**. **LOCK 2** balls by shooting for the **CENTER RAMP**. Then start **MULTIBALL** by shooting up the **RIGHT RAMP**.

CASH GRAB: The **LEFT RAMP** closes the bank door. Hitting the closed door spells "**B-A-N-K**". This starts **CASH GRAB**. **IN CASH GRAB, ALL RAMPS AWARD BIG POINTS!**

JACKPOT: While in **MULTIBALL** shoot for the **LEFT RAMP** or the **ELECTRIC COMPANY**. The **TRAIN RAMP RE-LITES JACKPOT**.

CHANCE: Shoot for the left **CHANCE ? CARD** scoop when lit for random awards.

HINT: Collect all the property to play **LAND GRAB!**









Note to Beginners: To score better, shoot at the ((FLASHING SHOTS)) !!
Be sure to **LOOK UP** at the Dot Display for instructions when possible.

© 2001 Hasbro, Inc. All Rights Reserved. ® Denotes U.S. trademarks. SPI PART N°: 755-5175-00 USA
Licensed by Hasbro's Consumer Products. Manufactured by Stern Pinball, Inc.



Portals™ Service Menu Introduction

Section 3 Table of Contents

Chapter 1, • INTRODUCTION		7
Service Switch Set (Red, Green & Black Buttons) Access & Use / How to Use This Section		8-9
	Portals™ Service Menu Icon Tree	10-11
Portals™ Service Menu Example and Exiting the Portals™ Service Menu		12-14
Chapter 2, • GO TO DIAGNOSTICS MENU		15
	•• Go To Switch Menu	16
	••• Switch Test / Active Switch Test / Dedicated Switch Test	16
	◊ Switch Matrix Grid & Dedicated Switches	16
	◊ Switch Matrix Grid Descriptions with Part Numbers and Locations	17
	•• Go To Coil Menu	18
	••• Single Coil Test / Cycling Coil Test	18
	◊ Coil & Flash Lamp Descriptions	18
	◊ Coil & Flash Lamp Locations	19
	◊ Coils Detailed Chart Table	20
	◊ Backbox I/O Power Driver Board Detailed Wiring Diagram	21
	•• Go To Lamp Menu	22
	••• Single Lamp Test / Test All Lamps / Row & Column Lamp Tests	22
	◊ Lamp Matrix Grid	22
	◊ Lamp Matrix Grid Locations	23
	•• Test Flash Lamps	24
	•• Clear Ball Trough	24
	•• Technician Alerts	24
	•• Service Phone #	24
	•• Begin Play Test	24
	•• Fire Knocker	24
	•• Sound / Speaker Test	24
	◊ Speaker Phase Testing	25
	•• Begin Burn In	25
	•• Dot Matrix Test & Dot Matrix Display Explained	25
	•• MONOPOLY® Tests (Bank Door Test, Water Works Flipper & Electric Company Sign)	26
	•• Dr. Pinball (Flow Chart Menus: Coil, Switch & Lamp)	27
Chapter 3, • GO TO AUDITS MENU		29
	◊ Game Audit Table	28
	•• Earnings Audits (Audits 1-12)	29
	•• S.P.I. Audits (Audits 13-55)	30-31
	•• MONOPOLY® Audits (Audits 56-110)	31-33
	•• Go To Printer Menu	33
	••• Quick Printout, Full Printout & Reset Printer	33
Chapter 4, • GO TO ADJUSTMENTS MENU		35
	◊ Game Adjustment Table	34
	•• S.P.I. Adjustments (Adjustments 1-45)	35-40
	•• MONOPOLY® Adjustments (Adjustments 46-63)	41
	•• Custom Message (Direct Access to Adjustment 34)	42
	•• Film Star Reset (Special Factory Reset Settings for the Home Environment)	42
Chapter 5, • GO TO RESET MENU		43
	•• Reset Coin Audits / Reset Game Audits / Factory Reset	43
	◊ Example	44
Chapter 6, • GO TO FUSE TABLE		45
	•• Go To Fuse Table	45
	◊ Example and Backbox Layout Locations: Fuses, Bridges, Relays & ROMs	45-46
Chapter 7, • GO TO HELP SCREEN		47
	•• Go To Help Screens (Multi-Level)	47
	◊ Problem / Solution Table	48

Sec. 3: ...Menu Intro.



Service Switch Set (Red, Green & Black Buttons) Access & Use

The **Service Switch Set** provides access for **three (3) functions** available for your use. They are **Volume Menu, Service Credits Menu** and **Portals™ Service Menu**. All are accessed separately depending on which colored button (**Red, Green or Black**) is **pushed first**.

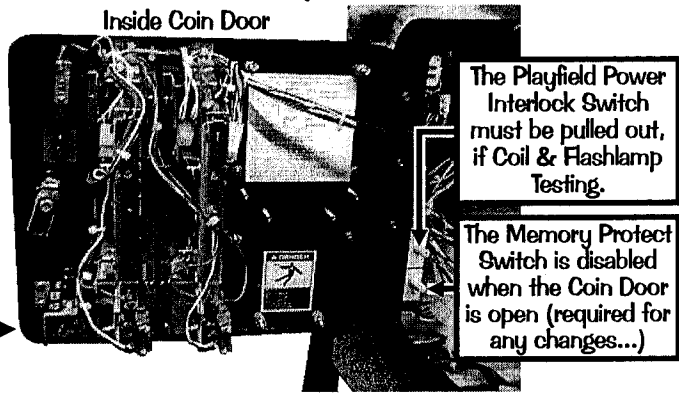
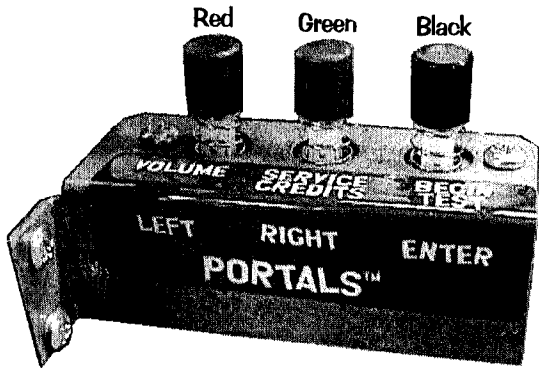

To access any of these **three (3) functions** you must first open the **Coin Door** (see pictorial above) with the Game in the **Attract Mode** (not already in any Function or Menu stated below).

Sec. 3: ...Menu Intro.

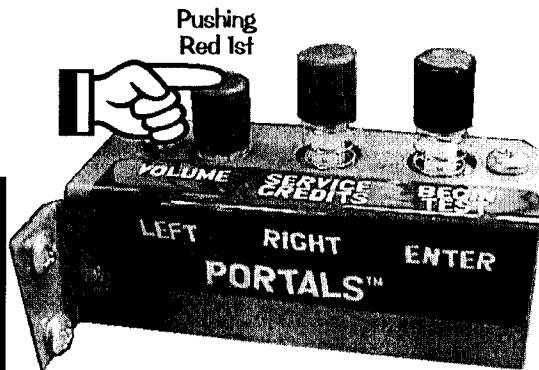

Function 1, Volume Menu

Pushing the Red Button first, enters the **Volume Menu**. While in this Mode, to **DECREASE** the volume, hold down or depress the **Red "LEFT" Button** until desired the volume is achieved; to **INCREASE** the volume, hold down or depress the **Green "RIGHT" Button** until the desired volume is achieved.

Note: Pushing the **Left or Right Flipper Buttons** operates the same as the **Red or Green Buttons** of the Service Switch Set, while in this Volume Mode.

Set between **0** and **31**; **15** is the **Factory Default**. Once your adjustments are made, this menu will **automatically exit** a few seconds after the last button depression.

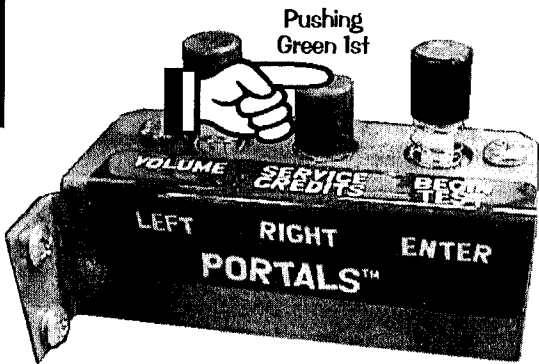

Function 2, Service Credits Menu

Pushing the Green Button first, adds **Service Credits** (will not affect your audits as "paid" credits). This is useful for the technician to test the game in regular play without affecting the game audits. Each depression adds **1 credit**; up to **50 credits** can be applied. **Adjustment 15, Credit Limit**, (Default = **30**) determines this, however, it can be changed from **04-50**; see Chapter 4 of this Section for details). Once your credits are added, this menu will **automatically exit** a few seconds after the last button depression.

Note: This function is disabled if **Adjustment 33, Free Play**, is set to **YES**. The **Service Credits** are limited to the **Credit Limit** in addition to any **paid credits** present in the game (e.g. If the **Credit Limit** is **30**, and there are **8 paid credits** present, only **22 Service Credits** can be applied.).

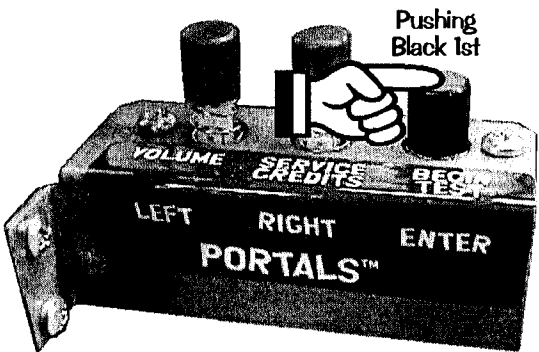

Function 3, Portals™ Service Menu

Pushing the Black Button first, enters the **Portals™ Service Menu**. Once in, move through the menus and sub-menus by pushing down or depressing the **Red "LEFT" or Green "RIGHT" Buttons**.

Note: Pushing the **Left or Right Flipper Buttons** operates the same as the **Red or Green Buttons** of the Service Switch Set, while in this Service Mode.

Select or activate the **Icon** chosen (the **Icon** will be "flashing") by pushing down or depressing the **Black "ENTER" Button**.

Note: Pushing the **Start Button** operates the same as the **Black Button** of the Service Switch Set, while in this Service Mode.

Please read the remainder of this Chapter for more information on the Portals™ Service Menu. The remaining six (6) Chapters of this Section explains all Icons & Menus in detail. Read! Read! Read!



Important: The *Dual Switch Bracket* holds the *Playfield Power Interlock & Memory Protect Switches*. It is located just inside the Coin Door frame (see pictorial of the *Coin Door* on the previous page). The Button Switch at the top is the *Playfield Power Interlock Switch*. It must be pulled out for electro-mechanical device testing or diagnostic purposes (this is required). If this button is pushed in, the *Playfield Power* is disabled while the *Coin Door* is **OPEN**. The Button Switch at the bottom is the *Memory Protect Switch*. It is enabled while the *Coin Door* is **CLOSED**; meaning any adjustment changes that are made **will not be written to memory**. If changing adjustments is required, ensure the *Coin Door* is **OPEN** to disable this switch, thus allowing for desired changes.

How to Use This Section

This section will cover all functions available in the **Portals™ Service Menu** in a *Step-By-Step* process. This section is divided into chapters which coincide with the **MAIN MENU**. The following pages in this chapter will instruct the operator on how to move through the menus. It's simple, easy and fun to use!

To get into the **Service Menu Mode** review "**Function 3, Portals™ Service Menu**" on the previous page. Push down the **Black "BEGIN TEST" Button** to begin. Looking at the Video Display you will momentarily see the introductory screen "**Service Menu**" with a *satellite flying from right to left pulling a banner "Portals©™"* followed by the **MAIN MENU**:

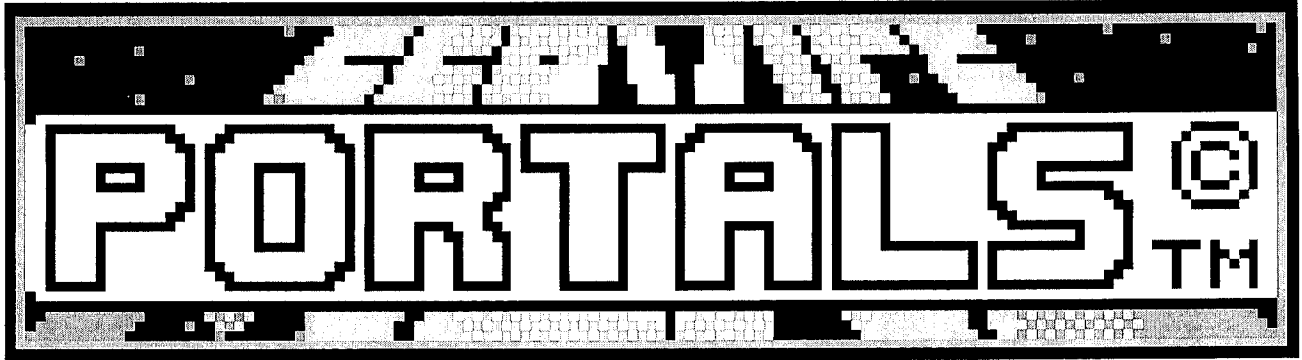

Use the **Red "LEFT" & Green "RIGHT" Buttons** (or **Left & Right Flipper Buttons**) to move the selected *Icon* left or right, and the **Black "ENTER" Button** (or **Start Button**) to activate the selected *Icon*. The use of the Service Switch Set (**Red, Green, & Black Buttons**) *is required* in **Switch Test** or **Active Switch Test**, as the **Start & Flipper Buttons** are a part of this test.

The **MAIN MENU** now appears with the "**DIAG**" *Icon* (**DIAGNOSTICS MENU**) flashing:

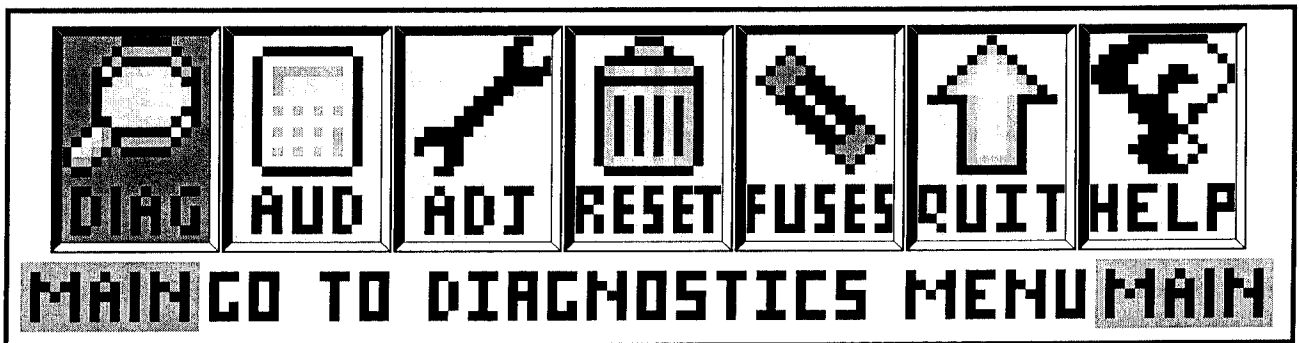

As the operator views the Menu Screen(s), the **MORE MORE** symbols indicates that there are more *Icons* to select in each direction. The *Icon* selected will blink. Pushing the **Black "ENTER" Button** (or **Start Button**) will select the *Icon* and the Menu Screen will change to the menu selected. Select the "**PREV**" *Icons* to move backwards through the menu levels. Select the "**QUIT**" *Icon* to completely exit the Service Mode.

View the **Portals™ Service Menu Icon Tree** on the next pages for a complete overview of all menus used in this system. View the last chapter (**HELP**) if more information is required. Selecting the "**QUIT**" *Icon* with the **Red "LEFT" or Green "RIGHT" Buttons** (or either **Flipper Button**), then pressing the **Black "ENTER" Button** (or **Start Button**) will exit the Service Mode. This applies to the large and small "**QUIT**" *Icons*.

The **chapters** in this **section**, which coincide with the **MAIN MENU**, will also provide more detailed information which could not fit in the display. Use both the manual and the display to help customize, troubleshoot and/or diagnose faults, if any.

Portals™ Service Menu Icon Tree for MONOPOLY Pinball Game

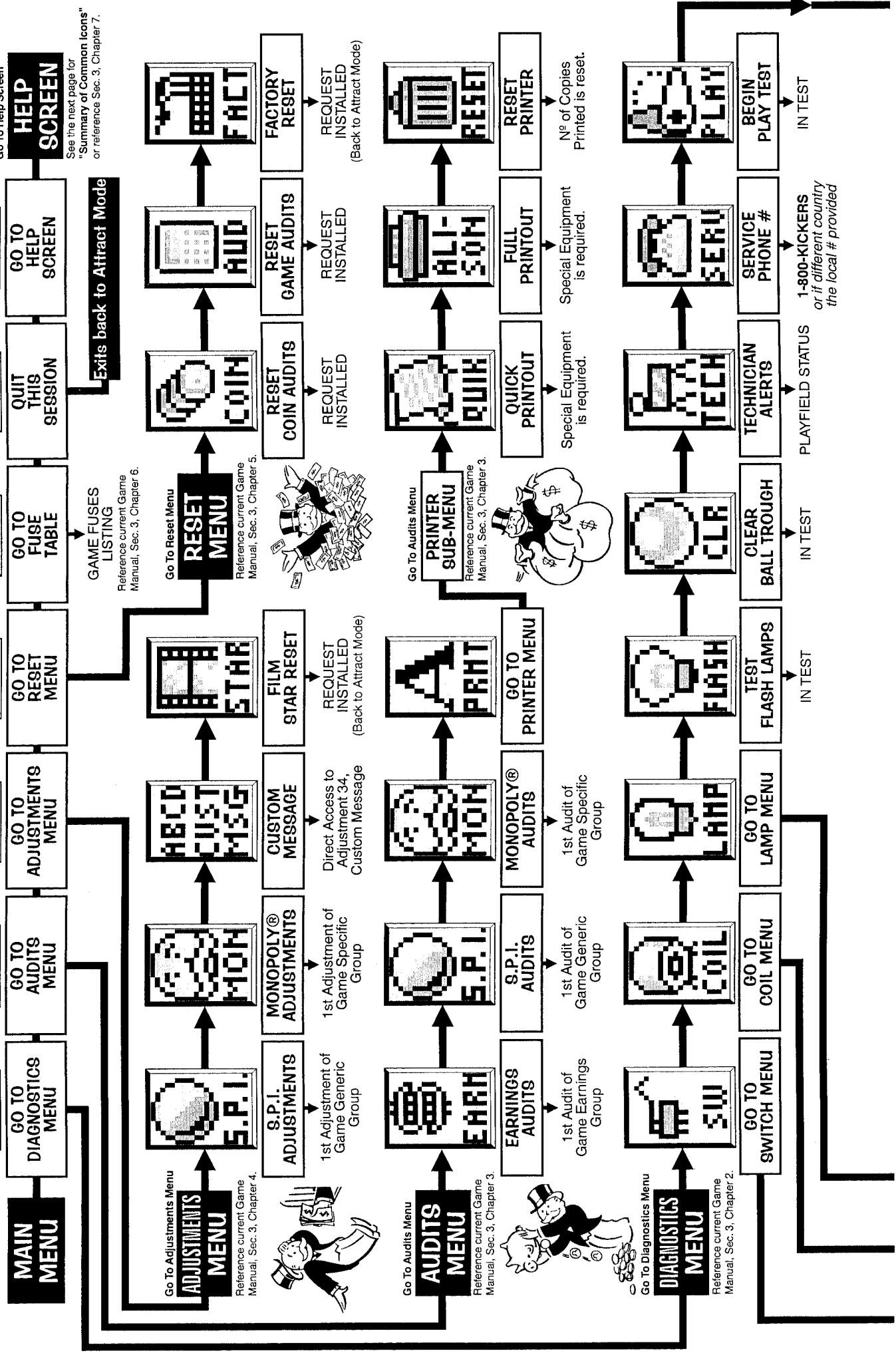

Go To Help Screen
See the next page for "Summary of Common Icons" or reference Sec. 3, Chapter 7.

Exits back to Attract Mode

GAME FUSES LISTING
Reference current Game Manual, Sec. 3, Chapter 6.

Go To Reset Menu
Reference current Game Manual, Sec. 3, Chapter 5.



Go To Audits Menu
Reference current Game Manual, Sec. 3, Chapter 3.



Go To Diagnostics Menu
Reference current Game Manual, Sec. 3, Chapter 2.



1-800-KICKERS
or if different country
the local # provided

PLAYFIELD STATUS

IN TEST

IN TEST

GO TO LAMP MENU

GO TO COIL MENU

GO TO SWITCH MENU

IN TEST

IN TEST

IN TEST

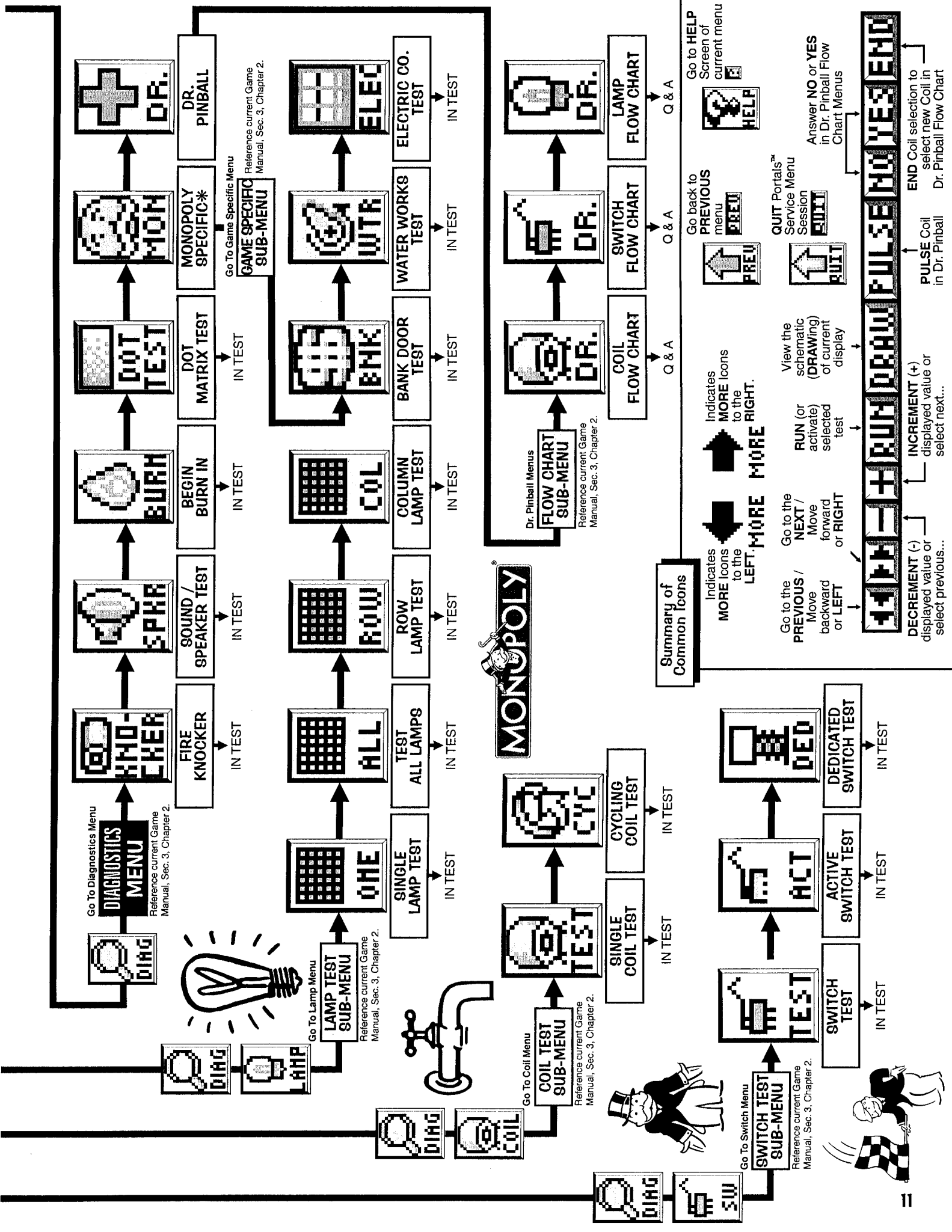

Summary of Common Icons

- Indicates MORE icons to the LEFT. MORE MORE RIGHT.
- Indicates MORE icons to the RIGHT. MORE MORE RIGHT.
- Go to the PREVIOUS / Move backward or LEFT.
- Go to the NEXT / Move forward or RIGHT.
- View the schematic (DRAWING) of current display.
- Go back to PREVIOUS menu.
- Go to HELP Screen of current menu.
- QUIT Portals™ Service Menu Session.
- Answer NO or YES in Dr. Pinball Flow Chart Menus.
- END Coil selection to select new Coil in Dr. Pinball.
- PULSE Coil in Dr. Pinball.
- INCREMENT (+) displayed value or select next...
- DECREMENT (-) displayed value or select previous...

Portals™ Service Menu Example

This example will demonstrate activation of *Icons* in the **DIAGNOSTICS MENU**. The example will show activation of the "SW" *Icon* (**GO TO SWITCH MENU**). In this menu, the switches can be tested individually and also all active switches can be tested. Use the same technique to access all the *Icons* in the **Portals™ Service Menu**. Follow **Portals™ Service Menu Icon Tree** on the previous pages as a guide to help navigate through the entire system (Also, go to the chapter in this manual explaining the icon(s) selected.).

If the display is in any other menu other than the **MAIN MENU**, use the **Red "LEFT" & Green "RIGHT" Buttons** to select the "PREV" *Icon* and press the **Black "ENTER" Button** to activate the **ICON** thus moving back to the previous menu. Do so until **MAIN MENU** appears.

Chapters 2 through 7 will cover all menu items within the **Portals™ Service Menu**. The *Icon* is shown preceding the text. Find the *Icon* in the **Portals™ Service Menu** by navigating with the **Red or Green Buttons**. Each chapter started is from the **MAIN MENU**. Within the chapter, the sub-menu's will be covered sequentially with their explanation & function. If the operator "*gets lost*", select and activate the "PREV" *Icon* until the display indicates **MAIN MENU**. For more help, see Chapter 7.



The "MORE" *symbols* are indicating that "*more icons*" are available which don't appear in the display and which way to move the selection to view the *Icons*.



Important Note:



Exit any sub-menu and return to the **MAIN MENU** by selecting & activating the "PREV" *Icons*. *If no Icons appear in the display because of a testing function or special display (e.g. Help, Schematic Display, etc.), press any service button to exit to the previous menu or sub-menu.*



Selecting & activating the "QUIT" *Icon* from any display will exit the *Service Session*.



Selecting & activating the "HELP" *Icon* will show a help screen. (An explanation of each *Mini-Icon* at that level will cycle continuously until any active button is pressed.)

Example: From the **MAIN MENU**, use the **Red "LEFT" or Green "RIGHT" Buttons** to select the "DIAG" *Icon* (**GO TO DIAGNOSTICS MENU**).

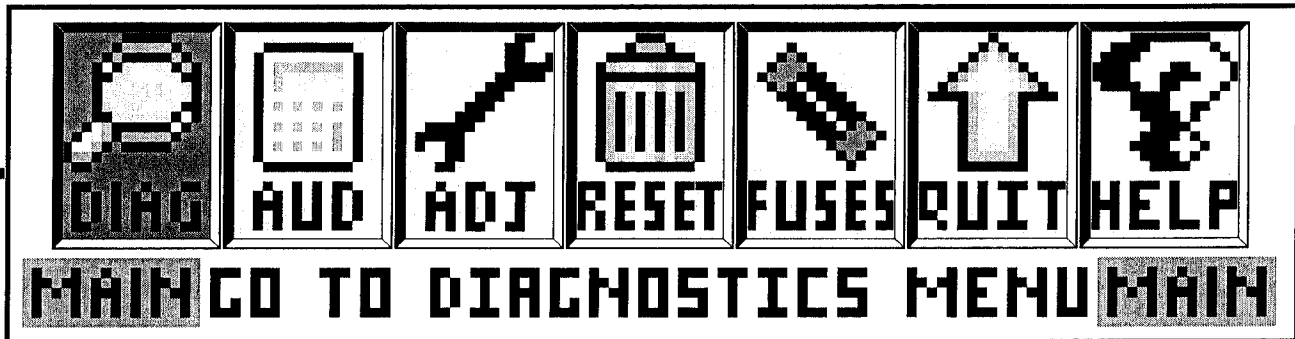

Press the **Black "ENTER" Button** to activate this **ICON**. This will bring up the **DIAGNOSTICS MENU**.

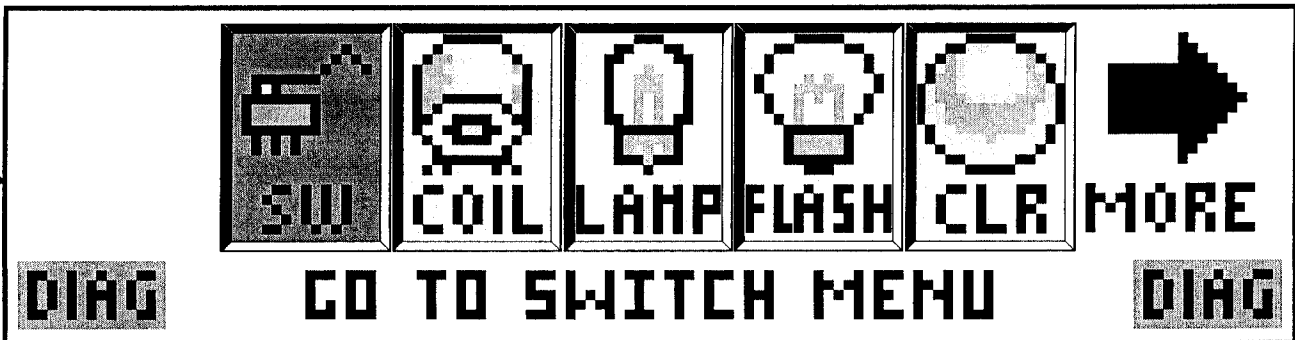

The **DIAGNOSTICS MENU** now appears with the "SW" *Icon* (**GO TO SWITCH MENU**) flashing. Press the **Black Button** to *activate* this icon. This will bring up the **SWITCH TEST MENU**.

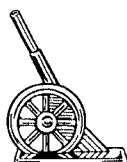

The **SWITCH TEST MENU** now appears with the "TEST" *Icon* (SWITCH TEST) flashing:
 Press the **Black "ENTER" Button** to *activate* this icon. This will bring up the **Switch Test Display**.

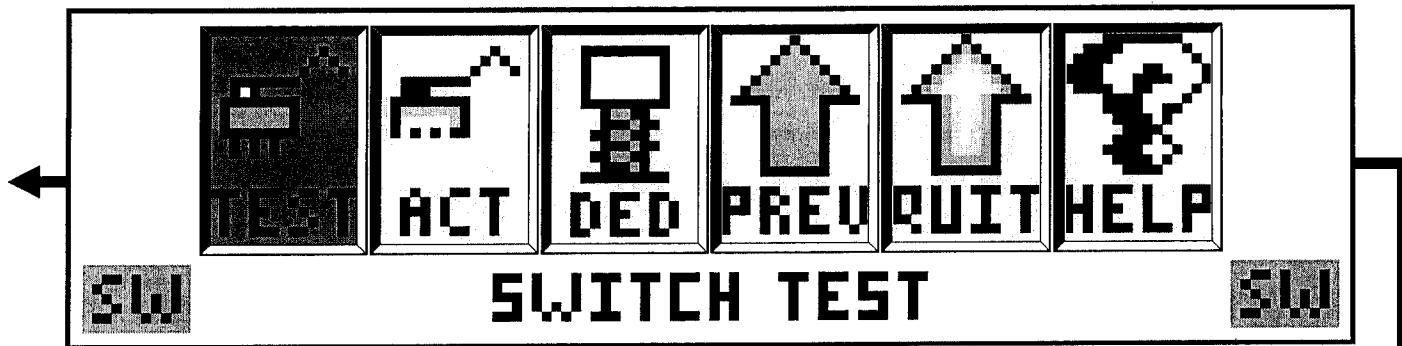

The **Switch Test Display** now appears.

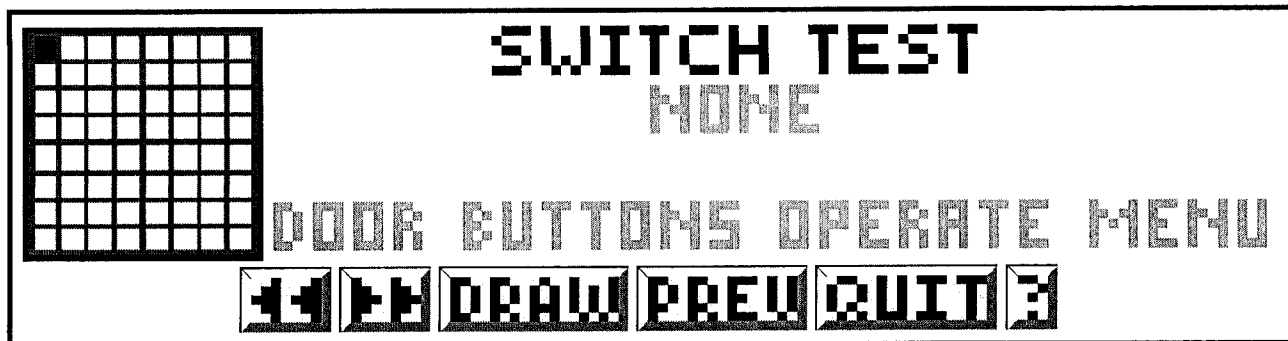

All switches can be tested one at a time (When possible, use a pinball to close any playfield switches; rolling the ball at Stand-Up Targets or over/under switches is suggested. Use finger for all non-playfield switches.) As each switch is closed, the respective Switch Matrix Grid Position (1-64) will be lit. To view the schematic for the switch selected, press either the **Red** or **Green Button** to select the "DRAW" *Mini-Icon*. Press the **Black Button** to *activate* this *Mini-Icon*; do so while the switch is momentarily closed. This will bring up the **Switch Schematic Display**. The display describes the switch in the Switch Matrix which includes the name of the switch, the Return (Row) Wire and the Drive (Column) Wire, drive transistor, and the "Pin-Outs" from the CPU/Sound Board. Activating the "DRAW" *Icon* when a switch is not closed, will give the generic switch schematic as shown below.

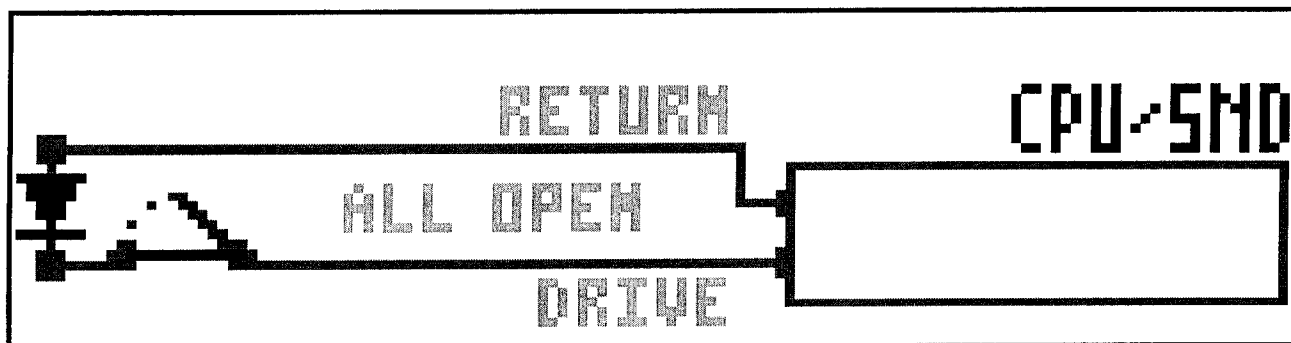

While in Switch or Active Switch Tests, the **Flipper & Start Buttons** are deactivated. Use the **Red "LEFT," Green "RIGHT"** and/or **Black "ENTER" Buttons** to select and activate the "**MINI-ICONS**" at the bottom of the display. In Switch Test, if the "Left Arrow" or "Right Arrow" *Mini-Icon* is activated, the display will go to the previous tests (Active and Dedicated Switch Tests). Use either the **Red** or **Green Button** to change the selected **ICON** to "PREV" *Mini-Icon*. Press the **Black "ENTER" Button** to go to the previous menu.

Note: In **Dedicated Switch Test**, the **Flipper & Start Buttons** are to be used instead of the **Red, Green & Black Service Buttons**, as these buttons are deactivated for this test.

Exit out of the sub-menu by activating the big "PREV" *Mini-Icon* in the menu. This will bring up the **DIAGNOSTICS MENU**. The Switch Test Session is now complete. See the next page about exiting the **Portals™ Service Menu**.

Sec. 3: ...Menu Intro.



Exiting the Portals™ Service Menu

All *Icons* will be covered in the chapters of this section with the exception of the "QUIT" *Icon*, in the **MAIN MENU**. Both the large and small *Icons* if selected and activated, will exit the user from the **Portals™ Service Menu**. The display will return back to the **ATTRACT MODE!** To re-enter the **Portals™ Service Menu** follow the instructions at the beginning of this chapter.

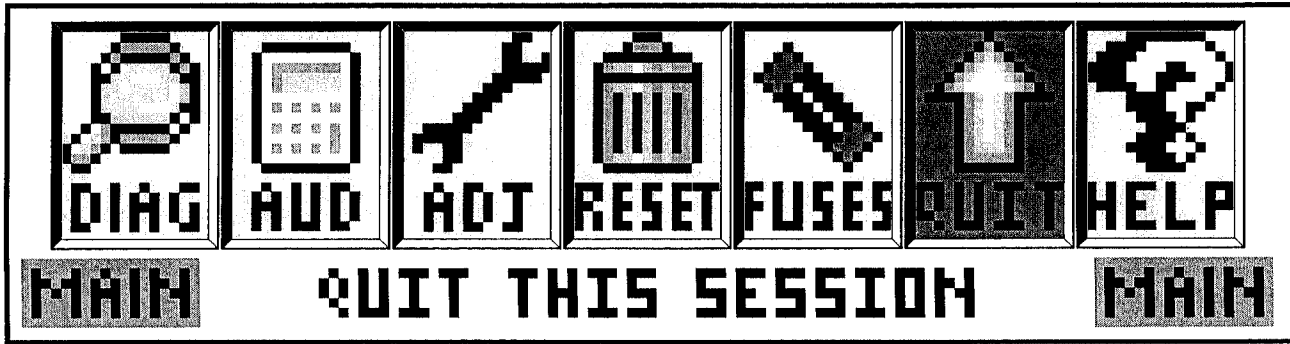

If more help is required, see Chapter 7 of this section, and view the various help displays in the game.

Sec. 3: ...Menu Intro.

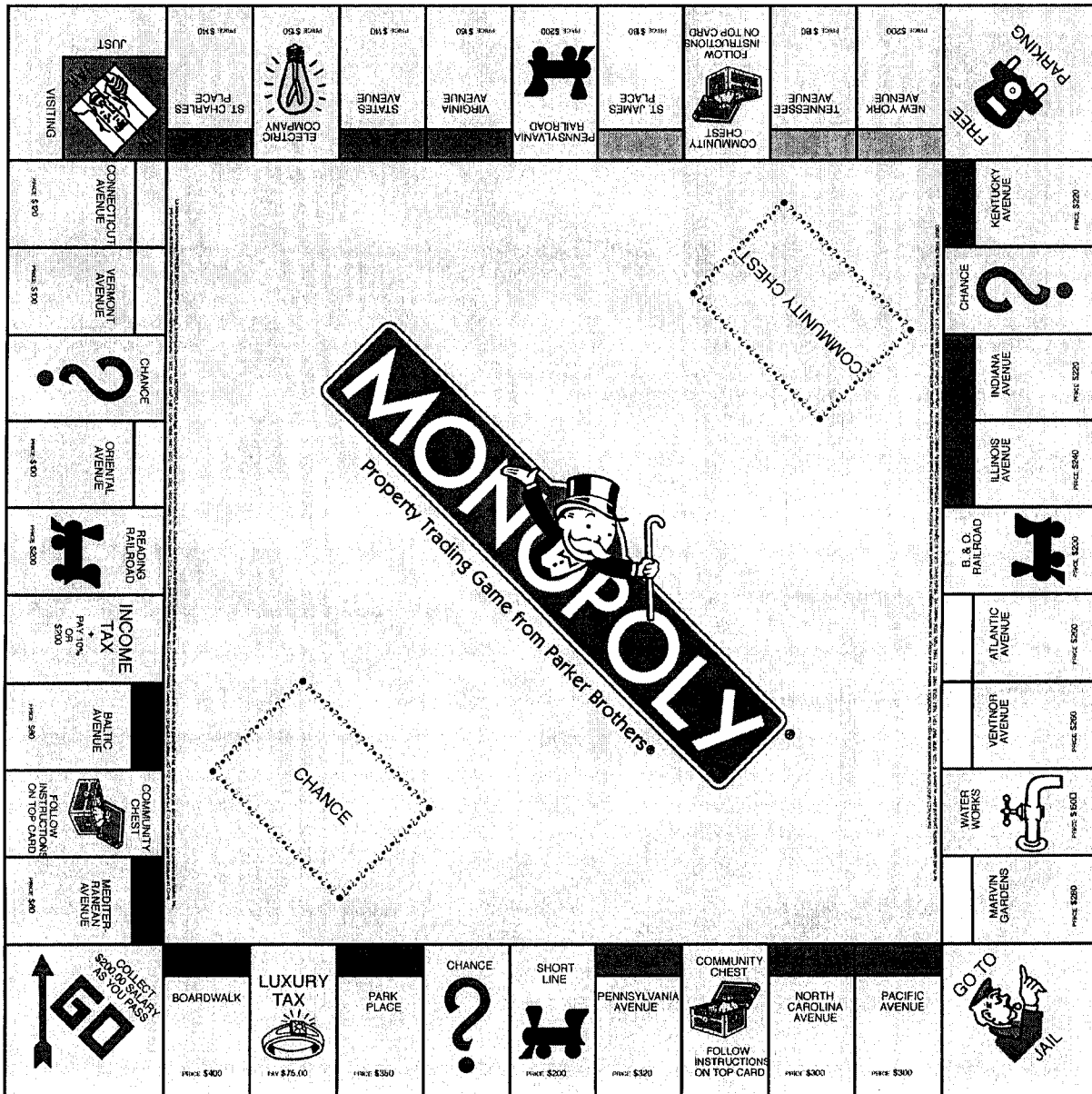

Go To Diagnostics Menu

Special Note: If the *display flashes "OPEN THE DOOR"* the game is indicating that memory has been corrupted. This is caused by either failure in memory (e.g. batteries are dead and/or faulty **RAM**) or upon installation of updated version of game code. Opening the **Coin Door** will initiate a *Factory Restore (Reset)*, by opening the **Memory Protect Switch**. Check battery voltage at **VBATT Test Point** on the **CPU/Sound Board**.

Overview

The **Portals™ Service Menu System** provides tests for sounds, display, lamps, switches and coils. Each feature may be tested manually or automatically after entering the **Portals™ Service Menu** (see Chapter 1 of this section). Select the "DIAG" *Icon* from the **MAIN MENU** to go to the **DIAGNOSTICS MENU**. The automatic tests (e.g. **Cycling Coils, Test Flash Lamps**) may be used for a quick verification of automatic test functions and the manual tests (**Begin Play Test, Single Lamp / All / Row / Column Tests, and Game Specific Test(s)**.) may be used for troubleshooting. All *Icons* and there usages are explained throughout this chapter.

During game play, activation of switches and operation of coils with associated switches are monitored. If the **CPU/Sound Board** does not detect a switch transition ("Stuck Open" / "Stuck Closed") for 50 games, it is considered faulty. When operation of a coil should close or open a switch and does not, the coil is considered faulty. In the Attract Mode, faulty switches and coils (if any) are reported (Select the "TECH" *Icon, Technician Alert*, from the **DIAGNOSTICS MENU**). *Note that reporting of an unused switch does not constitute a problem and that a bad coil could mean that the associated switch requires adjustment.*

CAUTION: Remove pinballs from the Ball Trough prior to lifting the playfield for servicing. This can easily be done in the **Portals™ Service Menu System**. Select the "DIAG" *Icon* from the **MAIN MENU** to go to the **DIAGNOSTICS MENU**. Select the "CLR" *Icon* to enter the **CLEAR BALL TROUGH MENU**. Select the "RUN" *Icon* & press the **Start Button** to remove one ball at a time. This is also useful to retrieve one ball for game testing in **Begin Play Test & Game Specific Test**. **Important:** The **Power Interlock Switch** must be pulled out.



GO TO DIAGNOSTICS MENU

With the game in the Attract Mode, open the Coin Door and press the **Black "BEGIN TEST" Button**. Select the "DIAG" *Icon* in the **MAIN MENU** with either **Flipper** or **Red "LEFT" & Green "Right" Buttons** (upon entry of the **Portals™ Service Menu**, the system defaults with the selection of the "DIAG" *Icon* flashing) and press the **Start** or **Black "ENTER" Buttons**. The **DIAGNOSTICS MENU** appears.



The "MORE" *symbols* are indicating that "more icons" are available which don't appear in the display and which way to move the selection to view the *Icons*.



Important Notes:



Exit any sub-menu and return to the **MAIN MENU** by selecting & activating the "PREV" *Icons*. If no *Icons* appear in the display because of a testing function or special display (e.g. "Help"), press any button to exit.



Selecting & activating the "QUIT" *Icon* from any display will exit the Service Session.



Selecting & activating the "HELP" *Icon* from any display will show a help screen. (An explanation of each *Mini-Icon* at that level will cycle continuously until any active button is pressed.)



In Diagnostics, selecting & activating the "-" or "+" *Icons* moves test forwards/backwards.



Selecting & activating the "RUN" *Icon* repeats the test on the coil or flash lamp left off at.



Selecting & activating the "ARROW" *Icons* moves between tests in the sub-menu.



Selecting & activating the "DRAW" *Icon* will show the schematic for that switch or coil.

Some tests require navigation through the menu(s) and selection of the *Icons* with **ONLY** the **Red "LEFT," Green "RIGHT"** and **Black "ENTER" Buttons**. This is required in **Switch & Active Switch Tests**, as the **Flipper & Start Buttons** are a part of the test.



In **Single Coil Test, Cycling Coil Test, Test Flash Lamps, Clear Ball Trough, Begin Play Test & Monopoly Tests** Menu's, the **Power Interlock Switch** (inside Coin Door) must be pulled out. (See **Access & Use** in Chapter 1 of this section for the location.)

If the **Power Interlock Switch** is not pulled out, all electro-mechanical devices (such as Coils) cannot be tested (20v & 50v DC power is disabled). Closing the **Coin Door** will automatically reset this switch.



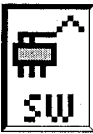

Go To Switch Menu

From the **DIAGNOSTICS MENU**, select the "SW" *Icon* with either **Red "LEFT"** or **Green "RIGHT" Button** and press the **Black "ENTER" Button**. Switches are configured in an 8 x 8 Matrix of Columns (Switch Drives) and Rows (Switch Returns) with up to 64 switches possible. The Switch Test Menu consists of three (3) parts: Switch Test, Active Switches, and Dedicated Switch Test.

Note: The Flipper & Start Buttons are deactivated during Switch Tests.



Switch Test

To initiate, from the **SWITCH MENU**, select the "TEST" *Icon* with the **Red or Green Button** & press the **Black Button**. In Switch Test, close each switch and observe the display. The display will describe the switch in the Switch Matrix, which includes the switch name, Return (Row) Wire, Drive (Column) Wire and the "Pin-Outs" from the CPU/SOUND Board. When the switch is closed, the information is displayed momentarily. To view the schematic for the switch selected, press either the **Red or Green Button** to select the "DRAW" *Mini-Icon*. Press the **Black Button** to activate this *Mini-Icon*; do so while the switch is momentarily closed. To return to Switch Test, press the **Black Button** again.



Active Switch Test

To initiate, from the **SWITCH MENU**, select the "ACT" *Icon* with either **Red or Green Button** & press the **Black Button**. If still in a previous test, select the "PREV" *Icon* to return to Switch Menu or selecting either of the "ARROW" *Icons* will move through the tests. If any switches are stuck closed (or made from the presence of a pinball), the display sequences through the Switch Names, Return (Row) Wire, Drive (Column) Wire, Drive Transistor, Part N^o, and the "Pin-Outs" from the CPU/SOUND Board. This cycle continues until all switches are cleared or until the test is exited.



Dedicated Switch Test

To initiate, from the **SWITCH MENU**, select the "DED" *Icon* with either **Flipper Button** & press the **Start Button** (The service switches are deactivated during this test.). The display will describe the switch which includes the Switch Name, Return (Row) Wire, Drive (Column) Wire, Part N^o, and the "Pin-Outs" from the CPU/SOUND Board.

SWITCH MATRIX GRID & DEDICATED SWITCHES

D i o d e O n T e r m i n a l S t r i p :										GND	
Column (Drive)	1: Q1	2: Q2	3: Q3	4: Q4	5: Q5	6: Q6	7: Q7	8: Q8	IC U206 INPUTS	Ground	
Row (Return)	GRN-BRN CN5-P1	GRN-RED CN5-P3	GRN-ORG CN5-P4	GRN-YEL CN5-P5	GRN-BLK CN5-P6	GRN-BLU CN5-P7	GRN-VIO CN5-P8	GRN-GRY CN5-P9	BLK CN6-P1, -P11		
1: U400	LEFT BUTTON (UK ONLY) on Cabinet side 1	CHANCE SCOOP on Assembly 9	LEFT TOP LANE (A) Under Playfield 17	RIGHT ORBIT Under Playfield 25	BANK OPTO 1 (L) On Assembly 33	LOWER BOTTOM POP On Assembly 41	UPPER LEFT POP On Assembly 49	LEFT OUTLANE Under Playfield 57	1: U206	#1 LEFT FLIPPER BUTTON on Cabinet side D9-1	
2: U400	4TH COIN SLOT On Coin Door 2	RAILROAD RAMP Above Playfield 10	MIDDLE TOP LANE (B) Under Playfield 18	ELECTRIC COMPANY On Assembly 26	BANK OPTO 2 On Assembly 34	LOWER RIGHT POP On Assembly 42	UPPER RIGHT POP On Assembly 50	LEFT RETURN LANE Under Playfield 58	2: U206	#2 LEFT FLIPPER E.O.S (End-of-Stroke) on Flipper Assy. D9-2	
3: U400	6TH COIN SLOT On Coin Door 3	4-BALL TROUGH #1 On Assembly 11	RIGHT TOP LANE (C) Under Playfield 19	DICE EJECT LANE Under Playfield 27	BANK OPTO 3 On Assembly 35	LOWER LEFT POP On Assembly 43	UPPER BOTTOM POP On Assembly 51	LEFT SLINGSHOT Under Playfield 59	3: U206	#3 RIGHT FLIPPER BUTTON on Cabinet side D9-3	
4: U400	RIGHT COIN SLOT On Coin Door 4	4-BALL TROUGH #2 On Assembly 12	LOCKUP 1 (TOP) Under Playfield 20	LEFT ORBIT Under Playfield 28	BANK OPTO 4 (R) On Assembly 36	100K STANDUP Under Playfield 44	DICE EJECT On Assembly 52	RIGHT OUTLANE Under Playfield 60	4: U206	#4 RIGHT FLIPPER E.O.S. (End-of-Stroke) on Flipper Assy. D9-4	
5: U401	CENTER COIN SLOT / DBA On Coin Door 5	4-BALL TROUGH #3 On Assembly 13	LOCKUP 2 Under Playfield 21	WATERWORKS EJECT On Assembly 29	NOT USED 37	SPINNER On Assembly 45	NOT USED 53	RIGHT RETURN LANE Under Playfield 61	5: U206	#5 UPPER FLIPPER (Double-Stacked) BUTTON with DS-3I on Cabinet side D9-5	
6: U401	LEFT COIN SLOT On Coin Door 6	4-BALL TROUGH VUK OPTO On Assembly 14	LOCKUP 3 (BOTTOM) Under Playfield 22	WORKS MINI FLIPPER On Assembly 30	COP DROP TARGET On Assembly 38	COP STANDUP X2 Under Playfield 46	START BUTTON Cabinet Front 54	RIGHT SLINGSHOT Under Playfield 62	6: U206	#6 VOLUME (RED BUTTON) (In Test: LEFT) on Coin Door D9-6	
7: U401	5TH COIN SLOT On Coin Door 7	4-BALL STACKING OPTO On Assembly 15	NOT USED 23	CENTER RAMP On Ramp Asm. 31	LEFT RAMP MID On Ramp Asm. 39	FREE PARKING Above Playfield 47	SLAM TILT On Coin Door 55	NOT USED 63	7: U206	#7 SERV. CRED. (GREEN BUTTON) (In Test: RIGHT) on Coin Door D9-7	
8: U401	RIGHT BUTTON (UK ONLY) on Cabinet side 8	SHOOTER LANE Under Playfield 16	NOT USED 24	NOT USED 32	NOT USED 40	RIGHT RAMP On Ramp Asm. 48	PLUMB BOB TILT Inside Cabinet 56	NOT USED 64	8: U206	#8 BEGIN TEST (BLACK BUTTON) (In Test: ENTER) on Coin Door D9-8	

Sec. 3: ... Diag. Menu

Typical Switch Schematic & Wiring

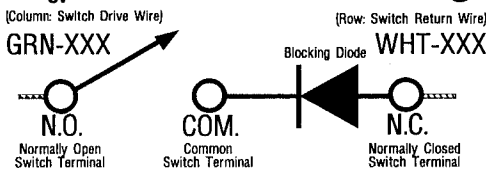

Note: All Switches require diodes. Some diodes are located on Terminal Strips OR Diode Boards (under playfield) & not on the switch itself.

D i o d e O n T e r m i n a l S t r i p

D i o d e O n D i o d e B o a r d

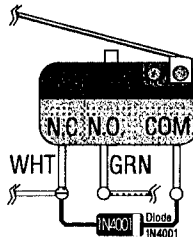

Dedicated Switch Schem.

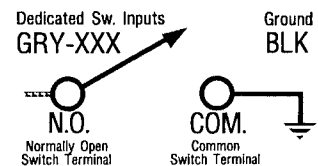

Switch Matrix Grid Descriptions with Part Numbers and Locations

The Switch locations correspond with the Switch N^o in the Part Number Table shown & the Switch Matrix Grid (previous page).

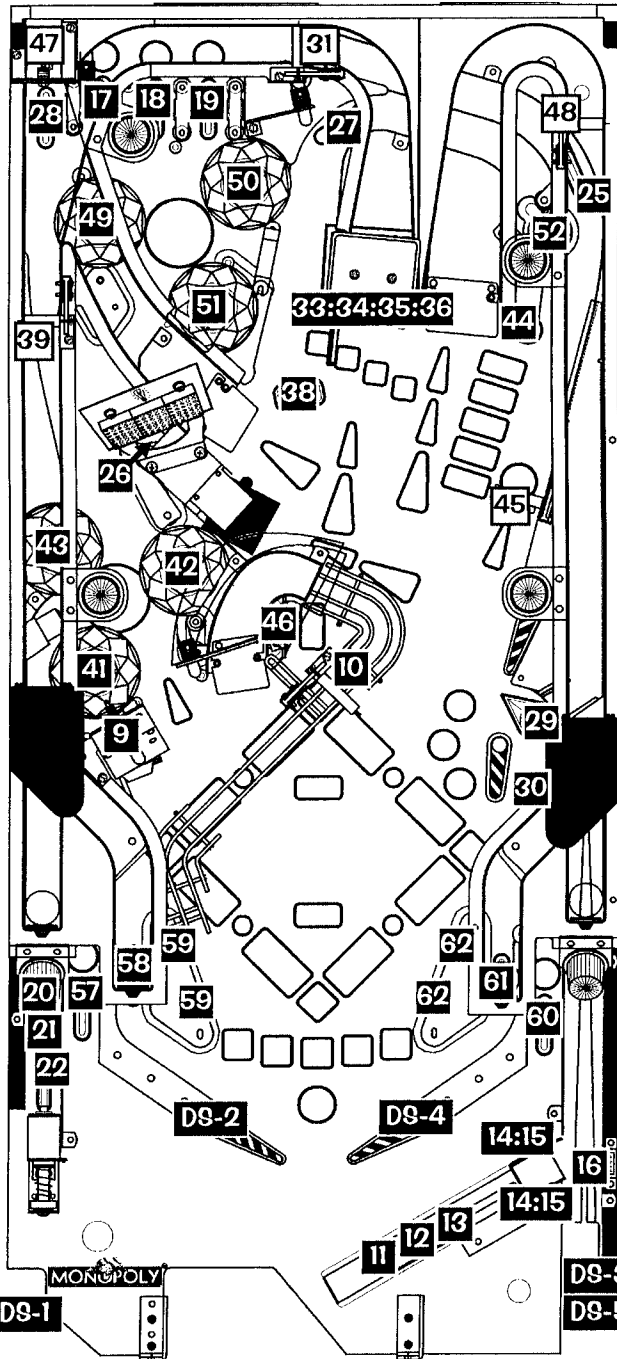

Legend Note:

□ = Switches mounted above playfield.

■ = Switches mounted below playfield.

DS: Dedicated Switches descriptions on previous page.

DOTS: Diode On Terminal Strip or DODB: Diode On Diode Board.

Note 1: Sw. 14 / Sw. 15 have both REC/TRANS on same board.
 Note 2: For a detailed switch description, see Playfield - General Parts & Switches, Pages 54-55.

Note 3: Switch sold only with Bracket.

Note 4: Switch Only; for entire Button Assembly, see Cabinet - General Parts & Switches, Pages 52-53.

Note 5: Switch located in/on Cabinet.

Note 6: Future Use.

Note 7: UK Only.

Sw. N ^o	Col. N ^o	Row N ^o	Dep. Notes	Switch Matrix Description	Part N ^o
Note: The ¥ Coin Switch (for Japan) is 180-5091-00					
1	1	1	5,7	LEFT BUTTON (UK ONLY)	180-5160-00
2	1	2	5	4TH COIN SLOT	180-5024-00
3	1	3	5,6	6TH COIN SLOT	(Future Use)
4	1	4	5	RIGHT COIN SLOT	
5	1	5	6	CENTER COIN SLOT / DBA	180-5024-00
6	1	6	5	LEFT COIN SLOT	
7	1	7	5,6	5TH COIN SLOT	(Future Use)
8	1	8	5,7	RIGHT BUTTON (UK ONLY)	180-5160-00
9	2	1		CHANCE SCOOP	180-5183-00
10	2	2		RAILROAD RAMP Sw. on Gate	180-5087-00
11	2	3		4-BALL TROUGH #1	
12	2	4		4-BALL TROUGH #2	180-5119-02
13	2	5		4-BALL TROUGH #3	
14	2	6	1	4-BALL TROUGH BOT TRANS: VUK OPTO BOT REC:	515-5073-00 515-5074-00
15	2	7	1	4-BALL STACKING OPTO TOP TRANS: TOP REC:	515-5073-00 515-5074-00
16	2	8		SHOOTER LANE	180-5157-00
17	3	1	2,3	LEFT TOP LANE (A) Switch w/ Rt. Brkt.	
18	3	2	2,3	MIDDLE TOP LANE (B) Sw. w/ Rt. Brkt.	500-6227-02
19	3	3	2,3	RIGHT TOP LANE (C) Sw. w/ Rt. Brkt.	
20	3	4		LOCKUP 1 (TOP) Sw. on Brkt. w/ 21 & 22	180-5178-00
21	3	5		LOCKUP 2 Switch on Brkt. with 20 & 22	180-5179-00
22	3	6		LOCKUP 3 (BOT) Sw. on Brkt. w/ 20 & 21	180-5180-00
23	3	7		NOT USED	
24	3	8		NOT USED	
25	4	1	2,3	RIGHT ORBIT Switch w/ Rt. Brkt.	500-6227-02
26	4	2		ELECTRIC COMPANY	180-5186-00
27	4	3	2,3	DICE EJECT LANE Switch w/ Rt. Brkt.	500-6227-02
28	4	4	2,3	LEFT ORBIT Switch w/ Lt. Brkt.	500-6227-01
29	4	5		WATERWORKS EJECT	180-5187-00
30	4	6		WWORKS MINI FLIPPER	180-5119-00
31	4	7		CENTER RAMP Sw. on Gate	180-5087-00
32	4	8		NOT USED	
33	5	1		BANK OPTO 1 (L)	Transmitter Bd
34	5	2		BANK OPTO 2	520-5218-00
35	5	3		BANK OPTO 3	Receiver Bd.
36	5	4		BANK OPTO 4 (R)	520-5210-00
37	5	5		NOT USED	
38	5	6	D016	COP DROP TARGET	180-5158-00
39	5	7		LEFT RAMP MID Sw. on Gate	180-5087-00
40	5	8		NOT USED	
41	6	1		LOWER BOTTOM POP	
42	6	2		LOWER RIGHT POP	180-5015-03
43	6	3		LOWER LEFT POP	
44	6	4	2	100K STANDUP	515-5162-06
45	6	5		SPINNER	180-5010-04
46	6	6	2	COP STANDUP X2	515-5162-06
47	6	7	2	FREE PARKING (STANDUP)	515-5967-06
48	6	8		RIGHT RAMP Sw. on Gate	180-5087-00
49	7	4		UPPER LEFT POP	
50	7	2		UPPER RIGHT POP	180-5015-03
51	7	3		UPPER BOTTOM POP	
52	7	4		DICE EJECT	180-5186-00
53	7	5		NOT USED	
54	7	6	4,5	START BUTTON	180-5174-00
55	7	7	5	SLAM TILT On Coin Door	180-5022-00
56	7	8	5	PLUMB BOB TILT HANGER CONTACT	535-5319-00 535-7563-01
57	8	1	2,3	LEFT OUTLANE Switch w/ Lt. Brkt.	500-6227-01
58	8	2	2,3	LEFT RETURN LANE Switch w/ Rt. Brkt.	500-6227-02
59	8	3	2	LEFT SLINGSHOT Leaf Sw. X2	180-5054-00
60	8	4	2,3	RIGHT OUTLANE Switch w/ Lt. Brkt.	500-6227-01
61	8	5	2,3	RIGHT RETURN LANE Sw. w/ Lt. Brkt.	
62	8	6	2	RIGHT SLINGSHOT Leaf Sw. X2	180-5054-00
63	8	7		NOT USED	
64	8	8		NOT USED	

Sec. 3: ... Diag. Menu



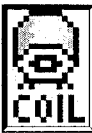

Go To Coil Menu

From the **DIAGNOSTICS MENU**, select the "COIL" *Icon* with either **Red "LEFT"** or **Green "RIGHT" Button** and press the **Black "ENTER" Button**. The coils are listed in groups. Coils 01-16 are typically High Current Coils (although Low Current Coils may be used in these positions & will be noted). Coils 17-32 are typically Low Current Coils. Flash Lamps are typically used in positions 26-32 (although may be used in any position & will be noted), read **Single Coil Test** below.



Single Coil Test

To initiate, from the **COIL MENU**, select the "TEST" *Icon* with either **Red** or **Green Button** and press the **Black Button**. Ensure the **Power Interlock Switch** is pulled out. Select either the "-" or "+" *Icons*. Start with the "+" *Icon* to start the manual Coil Test from #1 (The test runs through all Coils and Flash Lamps #1-#32 & AUX 1-3 (*Auxilliary Positions are Optional UK Only*)). Press the **Black Button** on the "+" *Icon*, as each coil is selected, the display will describe the Coil or Flash Lamp Name with the corresponding number, the wire with colors, the "Pin-Outs" from the I/O Power Driver Board, the Coil Voltage & Gauge-Turns (e.g. 23-800). Press the **Black Button** again to move forward in the test. To test and view a particular Coil or Flash Lamp, select the "RUN" *Icon* and press the **Black Button**. Each time the **Black Button** is pushed, the Coil or Flash Lamp will fire on the Playfield and/or Backbox, with the display indicating the Coil or Flash Lamp information. Continue with the same procedure to run through the entire test.

Important: The **Power Interlock Switch** must be pulled out for this *test to function* while the **Coin Door** is **OPEN**.



Cycling Coil Test

To initiate, from the **COIL MENU**, select the "CYC" *Icon* with either **Red** or **Green Button** and press the **Black Button**. If still in a previous test, select the "PREV" *Icon* to return to Coil Menu or selecting either of the "ARROW" *Icons* will move to Cycling Coil Test (selecting again will return to Coil Test). The test pulses each regular Coil or Flash Lamp sequentially (cycling) on the Playfield and Backbox. The display indicates "CYCLING COILS."

Important: The **Power Interlock Switch** must be pulled out for this *test to function* while the **Coin Door** is **OPEN**.

Coil & Flash Lamp Descriptions

#	Type	Coil / Flash Lamp Descriptions
1	Coil	TROUGH UP-KICKER (VUK) (26-1200)
2	Coil	AUTO LAUNCH (23-700)
3	Coil	LOWER LEFT POP (26-1200)
4	Coil	LOWER RIGHT POP (26-1200)
5	Coil	LOWER BOTTOM POP (26-1200)
6	Coil	BANK CLOSE (23-1100)
7	Coil	DROP TARGET RESET (24-940)
8	Coil	LOCK KICKER (23-800)
9	Coil	UPPER LEFT POP (26-1200)
10	Coil	UPPER RIGHT POP (26-1200)
11	Coil	UPPER BOTTOM POP (26-1200)
12	Coil	CHANCE SCOOP (23-800)
13	Coil	BANK OPEN (23-1100)
14	Coil	UPPER FLIPPER [50V RED/YEL] (23-1500)
15	Coil	LEFT FLIPPER [50V RED/YEL] (22-1080)
16	Coil	RIGHT FLIPPER [50V RED/YEL] (22-1080)

#	Type	Coil / Flash Lamp Descriptions
17	Coil	LEFT SLINGSHOT (23-800)
18	Coil	RIGHT SLINGSHOT (23-800)
19	Flash	FLASH RGT RAMP TOP (#906 Bulb)
20	Flash	FLASH RGT RAMP MID (X2) (#89/#906 Bulb)
21	Flash	FLASH LEFT RAMP TOP (X2) (#89/#906 Bulb)
22	Flash	FLASH LEFT RAMP MID (X2) (#89/#906 Bulb)
23	Flash	FLASH LEFT RAMP BOT (#906 Bulb)
24	Coil	(OPTIONAL COIN METER)
25	Coil	WATERWORKS MOTOR (EX00159A)
26	Coil	ELECTRIC COMPANY (23-800)
27	Coil	MOTOR RELAY (DC RELAY BD)
28	Coil	DICE EJECT (26-1200)
29	Flash	FLASH RGT RAMP BOT (#906 Bulb)
30	Coil	LEFT RAMP DIVERTER (32-1800)
31	Coil	RIGHT RAMP DIVERTER (32-1800)
32	Coil	TOP LANE UP/DN POST (26-1200)

See the next three (3) pages for the **Coil & Flash Lamp Location Maps** (corresponds to above tables), **Coils Detailed Chart Table** & the **Backbox I/O Power Driver Board Detailed Wiring Diagram**.

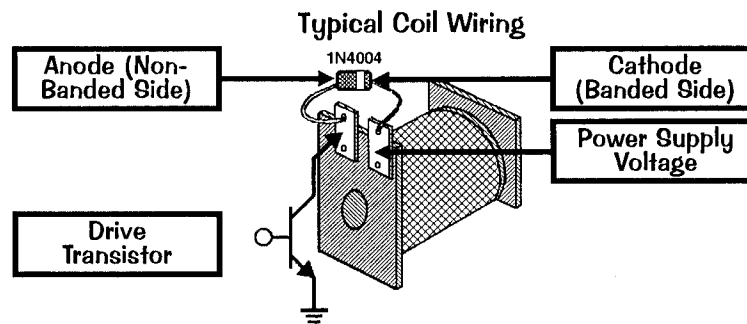

Note:
All Coils require diodes. Some diodes are located on Terminal Strips (under playfield) & not on the coil itself.

D iode
O n
T ermin
S trip

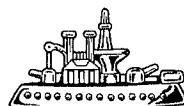

Coil & Flash Lamp Locations

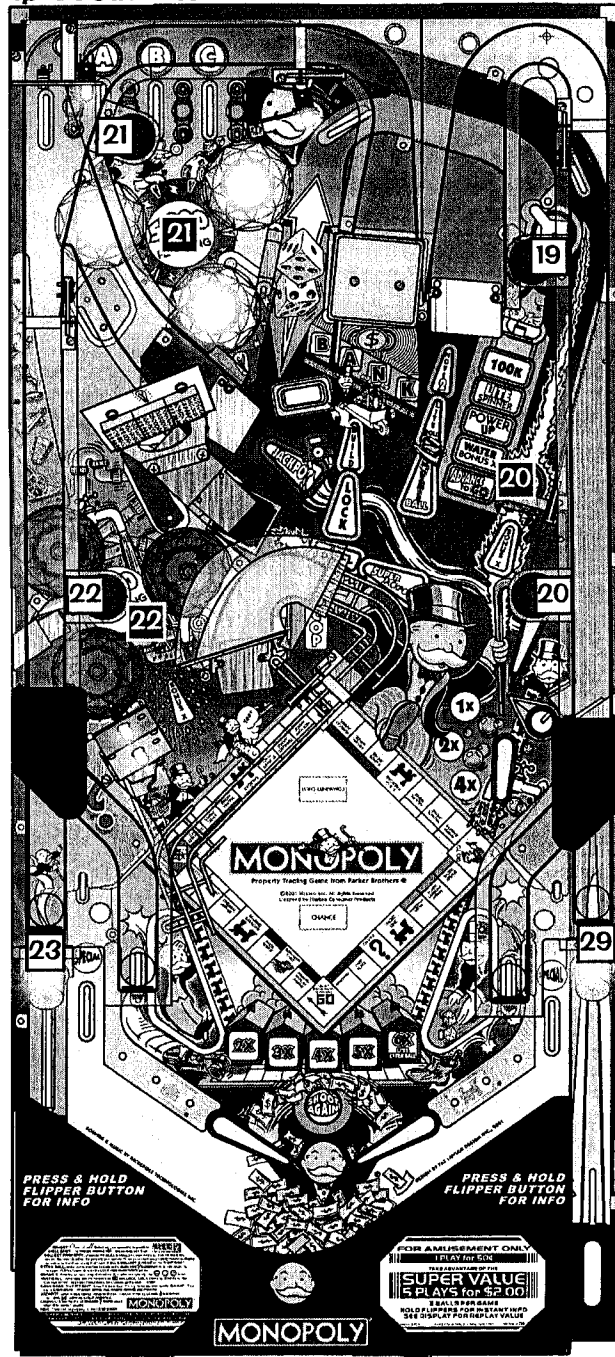
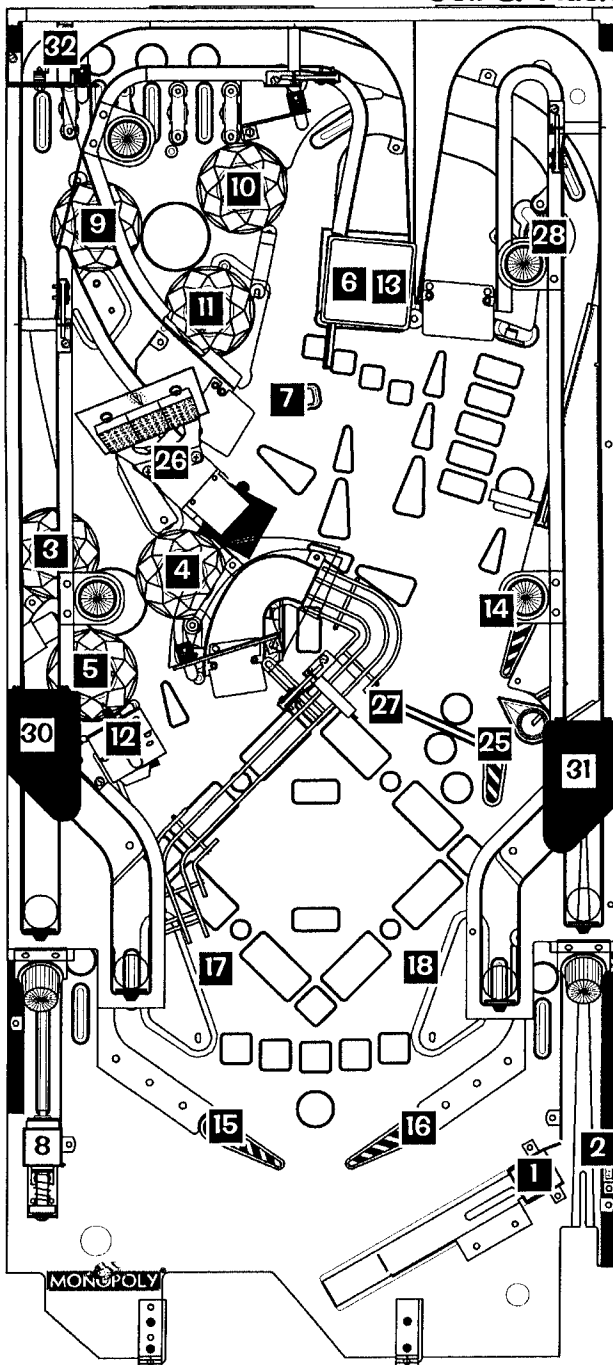

Sec. 3: ... Diag. Menu

Use the previous page and the following two (2) pages in conjunction with above Coil and Flash Lamp Maps.

Legend Note:

- = Coils and Flash Lamps mounted above playfield.
- = Coils and Flash Lamps mounted below playfield.

The following Coil is optional:

24

The following Bulb Types are used for Flash Lamps:



#89 Bulb
(Bayonet)
165-5000-89



#906 Bulb
(Wedge Base)
165-5004-00

The following Coils are for UK Only:

Aux. 1 Aux. 2 Aux. 3

Section 3, Chapter 2:
Go To Diagnostics Menu





From the Main Menu
in Portals™
GO TO DIAGNOSTICS
MENU



From the Diagnostics
Menu
GO TO COIL
MENU



From the Coil
Menu
GO TO COIL
TEST



From the Coil
Menu
GO TO CYCLING
COILS

COILS DETAILED CHART TABLE

High Current Coils Group 1		Drive Transistor (D.T.)	Driver Output Board	D.T. Control Line Color	D.T. Control Line Connect	Power Line Color	Power Line Connection	Power Voltage	Coil (GA-Turn) or Bulb Part #
#1	TROUGH UP-KICKER	Q1	I/O Pwr. Drvr.	BRN-BLK	J8-P1	YEL-VIO	J10-P4/5	50v DC	26-1200 090-5044-00T
#2	AUTO LAUNCH	Q2	I/O Pwr. Drvr.	BRN-RED	J8-P3	YEL-VIO	J10-P4/5	50v DC	23-700 090-5022-00T
#3	LOWER LEFT POP	Q3	I/O Pwr. Drvr.	BRN-ORG	J8-P4	YEL-VIO	J10-P4/5	50v DC	26-1200 090-5044-00T
#4	LOWER RIGHT POP	Q4	I/O Pwr. Drvr.	BRN-YEL	J8-P5	YEL-VIO	J10-P4/5	50v DC	26-1200 090-5044-00T
#5	LOWER BOTTOM POP	Q5	I/O Pwr. Drvr.	BRN-GRN	J8-P6	YEL-VIO	J10-P4/5	50v DC	26-1200 090-5044-00T
#6	BANK CLOSE	Q6	I/O Pwr. Drvr.	BRN-BLU	J8-P7	YEL-VIO	J10-P4/5	50v DC	23-1100 090-5030-00T
#7	DROP TARGET RESET	Q7	I/O Pwr. Drvr.	BRN-VIO	J8-P8	YEL-VIO	J10-P4/5	50v DC	24-940 090-5036-00B
#8	LOCK KICKER	Q8	I/O Pwr. Drvr.	BRN-GRY	J8-P9	YEL-VIO	J10-P4/5	50v DC	23-800 090-5001-00B

High Current Coils Group 2		Drive Transistor (D.T.)	Driver Output Board	D.T. Control Line Color	D.T. Control Line Connect	Power Line Color	Power Line Connection	Power Voltage	Coil (GA-Turn) or Bulb Part #
#9	UPPER LEFT POP	Q9	I/O Pwr. Drvr.	BLU-BRN	J9-P1	YEL-VIO	J10-P4/5	50v DC	26-1200 090-5044-00T
#10	UPPER RIGHT POP	Q10	I/O Pwr. Drvr.	BLU-RED	J9-P2	YEL-VIO	J10-P4/5	50v DC	26-1200 090-5044-00T
#11	UPPER BOTTOM POP	Q11	I/O Pwr. Drvr.	BLU-ORG	J9-P4	YEL-VIO	J10-P4/5	50v DC	26-1200 090-5044-00T
#12	CHANCE SCOOP	Q12	I/O Pwr. Drvr.	BLU-YEL	J9-P5	YEL-VIO	J10-P4/5	50v DC	23-800 090-5001-00B
#13	BANK OPEN	Q13	I/O Pwr. Drvr.	BLU-GRN	J9-P6	YEL-VIO	J10-P4/5	50v DC	23-1100 090-5030-00T
#14	UPPER FLIPPER (50v RED/YEL)	Q14	I/O Pwr. Drvr.	BLU-BLK	J9-P7	RED-YEL GRY-YEL	J10-P1/2	50v DC	23-1500 090-5062-00
#15	LEFT FLIPPER (50v RED/YEL)	Q15	I/O Pwr. Drvr.	ORG-GRY	J9-P8	RED-YEL GRY-YEL	J10-P1/2	50v DC	22-1080 090-5032-00T
#16	RIGHT FLIPPER (50v RED/YEL)	Q16	I/O Pwr. Drvr.	ORG-VIO	J9-P9	RED-YEL BLU-YEL	J10-P1/2	50v DC	22-1080 090-5032-00T

Low Current Coils Group 1		Drive Transistor (D.T.)	Driver Output Board	D.T. Control Line Color	D.T. Control Line Connect	Power Line Color	Power Line Connection	Power Voltage	Coil, Bulb or Meter Part #
#17	LEFT SLINGSHOT	Q17	I/O Pwr. Drvr.	VIO-BRN	J7-P2	BRN	J7-P1	20v DC	23-800 090-5001-00T
#18	RIGHT SLINGSHOT	Q18	I/O Pwr. Drvr.	VIO-RED	J7-P3	BRN	J7-P1	20v DC	23-800 090-5001-00T
#19	FLASH RGT RAMP TOP	Q19	I/O Pwr. Drvr.	VIO-ORG	J7-P4	ORG	J6-P10	20v DC	#906 Bulb 165-5004-00
#20	FLASH RGT RAMP MID (X2)	Q20	I/O Pwr. Drvr.	VIO-YEL	J7-P6	ORG	J6-P10	20v DC	#89 Bulb 165-5000-89
#21	FLASH LEFT RAMP TOP (X2)	Q21	I/O Pwr. Drvr.	VIO-GRN	J7-P7	ORG	J6-P10	20v DC	#89 Bulb 165-5000-89
#22	FLASH LEFT RAMP MID (X2)	Q22	I/O Pwr. Drvr.	VIO-BLU	J7-P8	ORG	J6-P10	20v DC	#89 Bulb 165-5000-89
#23	FLASH LEFT RAMP BOT	Q23	I/O Pwr. Drvr.	VIO-BLK	J7-P9	ORG	J6-P10	20v DC	#906 Bulb 165-5004-00
#24	OPTIONAL COIN METER	Q24	I/O Pwr. Drvr.	VIO-GRY	J7-P10	RED	J16-P7	5v DC	Meter 5v 091-5000-00

Diode On Terminal Strip (if noted)

Low Current Coils Group 2		Drive Transistor (D.T.)	Driver Output Board	D.T. Control Line Color	D.T. Control Line Connect	Power Line Color	Power Line Connection	Power Voltage	Coil (GA-Turn) or Bulb Part #
#25	WATERWORKS MOTOR	Q25	I/O Pwr. Drvr.	BLK-BRN	J6-P1	BRN	J7-P1	20v DC	EX00159A 041-5083-00
#26	ELECTRIC COMPANY	Q26	I/O Pwr. Drvr.	BLK-RED	J6-P2	BRN	J7-P1	20v DC	23-800 090-5001-00T
#27	MOTOR RELAY	Q27	I/O Pwr. Drvr.	BLK-ORG	J6-P3	BRN	J7-P1	20v DC	DC Relay 520-5066-00
#28	DICE EJECT	Q28	I/O Pwr. Drvr.	BLK-YEL	J6-P4	BRN	J7-P1	20v DC	26-1200 090-5044-00T
#29	FLASH RGT RAMP BOT	Q29	I/O Pwr. Drvr.	BLK-GRN	J6-P5	ORG	J6-P10	20v DC	#906 Bulb 165-5004-00
#30	LEFT RAMP DIVERTER	Q30	I/O Pwr. Drvr.	BLK-BLU	J6-P6	BRN	J7-P1	20v DC	32-1800 090-5031-00
#31	RIGHT RAMP DIVERTER	Q31	I/O Pwr. Drvr.	BLK-VIO	J6-P7	BRN	J7-P1	20v DC	32-1800 090-5031-00
#32	TOP LANE UP/DN POST	Q32	I/O Pwr. Drvr.	BLK-GRY	J6-P8	BRN	J7-P1	20v DC	26-1200 090-5044-00T

Note: In Test Flash Lamps Menu ("Flash" Icon), Flashers tested are all Flash Lamps located between Q1-Q32 (This Game:)

Auxiliary (UK ONLY)		Drive Transistor (D.T.)	Driver Output Board	D.T. Control Line Color	D.T. Control Line Connect	Power Line Color	Power Line Connection	Power Voltage	Coil (GA-Turn) or Bulb Part #
AUX 1:	LEFT UP/DOWN POST	Q1	Sol. Expander (Aux. Board)	WHT	J3-P11	BRN	J7-P1	20v DC	26-1200 090-5044-00T
AUX 2:	CENTER UP/DOWN POST	Q2	Sol. Expander (Aux. Board)	RED	J3-P10	BRN	J7-P1	20v DC	23-1100 090-5030-00T
AUX 3:	RIGHT UP/DOWN POST	Q3	Sol. Expander (Aux. Board)	ORG	J3-P9	BRN	J7-P1	20v DC	26-1200 090-5044-00T

Sec. 3: ... Diag. Menu



Backbox I/O Power Driver Board Detailed Wiring Diagram

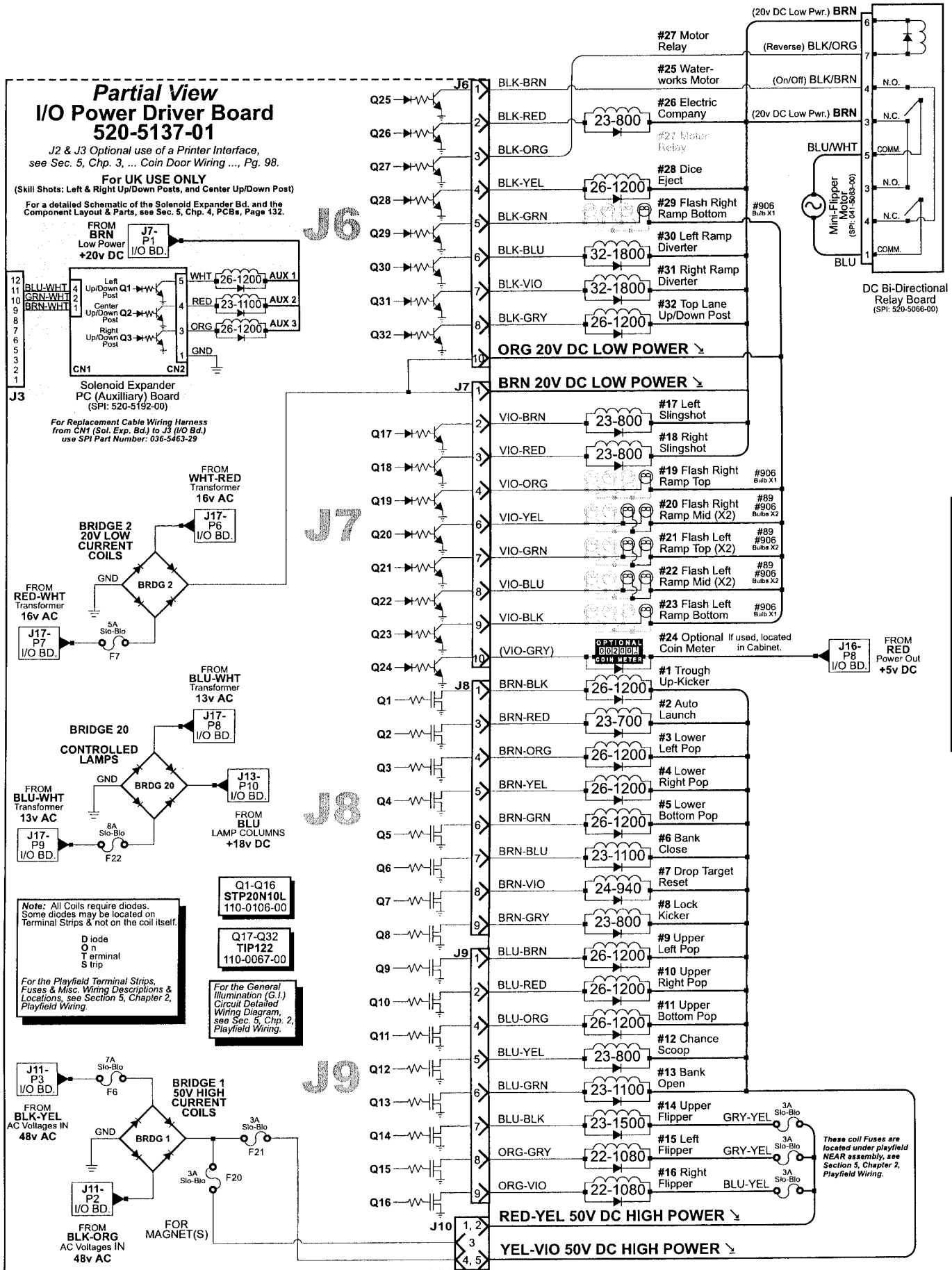

Sec. 3: ... Diag. Menu

Section 3, Chapter 2:
Go To Diagnostics Menu





Go To Lamp Menu

From the **DIAGNOSTICS MENU**, select the "LAMP" *Icon* with either **Red "LEFT"** or **Green "RIGHT"** **Button** and press the **Black "ENTER" Button**. Controlled lamps are configured in an 8 x 10 Matrix of Columns (Lamp Drives) and Rows (Lamp Returns) with up to 80 lamps possible. The Lamp Test Menu consists of four (4) parts: Single Lamp Test, Test All Lamps, Row Lamp Test and Column Lamp Test.

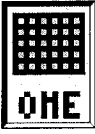

Single Lamp Test

To initiate, from the **LAMP MENU**, select the "ONE" *Icon* with either **Red** or **Green Button** and press the **Black Button**. Select either the "-" or "+" *Icons*. Start with the "+" *Icon* to start the manual Lamp Test from Column 1, Row 1, Switch 1. Press the **Black Button** on the "+" *Icon*, as each lamp is selected, the lamp will light at it's location on the playfield as well as the display, indicating the Lamp Matrix Grid Position, lamp name with the corresponding number, Return (Row) Wire & Color, Drive (Column) Wire & Color, and associated drive transistors. Press the **Black Button** again to move forward in the test. To test and view a particular lamp, select the "RUN" *Icon* and press the **Black Button**. Each time the **Black Button** is pushed, the lamp will light-up on the playfield, with the display indicating the lamp information. Continue with the same procedure to run through the entire test.

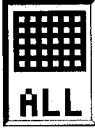

Test All Lamps

To initiate, from the **LAMP MENU**, select the "ALL" *Icon* with either **Red** or **Green Button** and press the **Black Button**. If still in Single Lamp Test (or any 1 of the 4 tests), select the "PREV" *Icon* to return to Lamp Menu or selecting either of the "ARROW" *Icons* will move through the tests, keep activating until Test All Lamps is displayed. The display will indicate "ALL LAMPS ON" and the lamps on the playfield will be lit, alternating between the rows in the Lamp Matrix Grid.

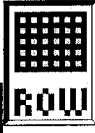

Row & Column Lamp Tests

To initiate, from the **LAMP MENU**, select the "ROW" or "COL" *Icon* with either **Red "LEFT"** or **Green "RIGHT" Button** and press the **Black Button**. If still in a previous test, select the "PREV" *Icon* to return to Lamp Menu or selecting either of the "ARROW" *Icons* will move through the tests, keep activating until Row or Column Lamp Test (whichever desired) is displayed. In this test, each set of lamps in each Row or Column of the Lamp Matrix Grid (respective to each test) will light-up on the playfield and is indicated in the display.

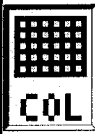

LAMP MATRIX GRID

Code On Terminal Strip:	Column (18v)	1: UI7	2: UI6	3: UI5	4: UI4	5: UI3	6: UI2	7: UI1	8: UI0
Row (GND)		YEL-BRN J13-P9	YEL-RED J13-P8	YEL-ORG J13-P7	YEL-BLK J13-P6	YEL-ORN J13-P5	YEL-BLU J13-P4	YEL-VIO J13-P3	YEL-ORY J13-P1
1: Q33	RED-BRN J12-P1	LEFT OUTLANE #555 Bulb 1	BONUS 2X #555 Bulb 2	BONUS 3X #555 Bulb 3	BONUS 4X #555 Bulb 4	BONUS 5X #555 Bulb 5	BONUS 6X #555 Bulb 6	SHOOT AGAIN #555 Bulb 7	RIGHT OUTLANE #555 Bulb 8
2: Q34	RED-BLK J12-P2	GO #555 Bulb 9	MEDITER-RANEAN #555 Bulb 10	COMM CHEST #555 Bulb 11	BALTIC #555 Bulb 12	READING RR #555 Bulb 13	ORIENTAL #555 Bulb 14	VERMONT #555 Bulb 15	CONNECTI-CUT #555 Bulb 16
3: Q35	RED-ORG J12-P3	IN JAIL #555 Bulb 17	ST CHARLES #555 Bulb 18	STATES #555 Bulb 19	VIRGINIA #555 Bulb 20	PENN RR #555 Bulb 21	ST JAMES #555 Bulb 22	TENNESSEE #555 Bulb 23	NEW YORK #555 Bulb 24
4: Q36	RED-YEL J12-P4	FREE PARKING #555 Bulb 25	KENTUCKY #555 Bulb 26	INDIANA #555 Bulb 27	ILLINOIS #555 Bulb 28	B.O. RR #555 Bulb 29	ATLANTIC #555 Bulb 30	VENTNOR #555 Bulb 31	MARVIN GARDENS #555 Bulb 32
5: Q37	RED-ORN J12-P5	GO TO JAIL #555 Bulb 33	PACIFIC #555 Bulb 34	NORTH CAROLINA #555 Bulb 35	PENNSYLVANIA #555 Bulb 36	SHORT LINE RR #555 Bulb 37	CHANCE #555 Bulb 38	PARK PLACE #555 Bulb 39	BOARDWALK #555 Bulb 40
6: Q38	RED-BLU J12-P6	LOWER BOTTOM POP #555 Bulb 41	LOWER LEFT POP #555 Bulb 42	RELIGHT JACKPOT #555 Bulb 43	RAILROAD LIT #555 Bulb 44	L BONUS X #555 Bulb 45	LOWER RIGHT POP #555 Bulb 46	COMM CHEST LIT #555 Bulb 47	FREE PARKING #555 Bulb 48
7: Q39	RED-VIO J12-P8	CHANCE LIT #555 Bulb 49	3000 WHEN FLASHING #555 Bulb 50	ROLL #555 Bulb 51	SUPER JACKPOT #555 Bulb 52	WATERWORKS 1X #555 Bulb 53	WATERWORKS 2X #555 Bulb 54	WATERWORKS 4X #555 Bulb 55	R BONUS X #555 Bulb 56
8: Q40	RED-ORY J12-P9	LEFT TOP LANE (A) #555 Bulb 57	MIDDLE TOP LANE (B) #555 Bulb 58	RIGHT TOP LANE (C) #555 Bulb 59	UPPER LEFT POP #555 Bulb 60	UPPER RIGHT POP #555 Bulb 61	UPPER BOTTOM POP #555 Bulb 62	ROLL AND COLLECT #555 Bulb 63	EXTRA BALL #555 Bulb 64
9: Q41	RED-WHT J12-P10	BA (N) K #555 Bulb 65	BAN (K) #555 Bulb 66	LOCK #555 Bulb 67	COP #555 Bulb 68	BUILD LITE SPINNER #555 Bulb 69	JACKPOT #555 Bulb 70	(B) ANK #555 Bulb 71	B (A) NK #555 Bulb 72
10: Q42	RED J12-P11	MOVE 2 #555 Bulb 73	LITE ROLL #555 Bulb 74	MULTIBALL #555 Bulb 75	100,000 #555 Bulb 76	LITE SPINNER #555 Bulb 77	POWER UP #555 Bulb 78	WATER BONUS X #555 Bulb 79	ADVANCE TO GO #555 Bulb 80

Sec. 3: ... Diag. Menu



Lamp Matrix Grid Locations

The lamp locations correspond with the Lamp N° in the Lamp Matrix Grid on the previous page.

Legend Note:

- = Lamps mounted above playfield.
- = Lamps mounted below playfield.

The following Bulbs are used in the Lamp Matrix Grid (See Table Grid on previous page for details):

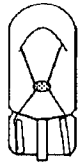

#555 Bulb (Wedge)
165-5002-00

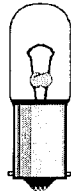

#44 Bulb (Bayonet)
165-5000-44

Typical Lamp Schematic

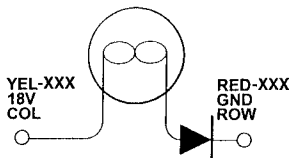

Typical Lamp Wiring

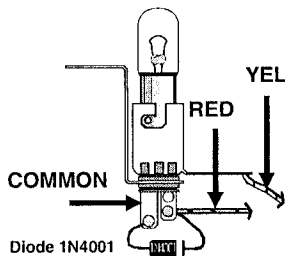

Note:
All Lamps require diodes. Some diodes are located on Terminal Strips (under the playfield) and not on the lamp itself. DOTS: D iode O n T erminal S trip

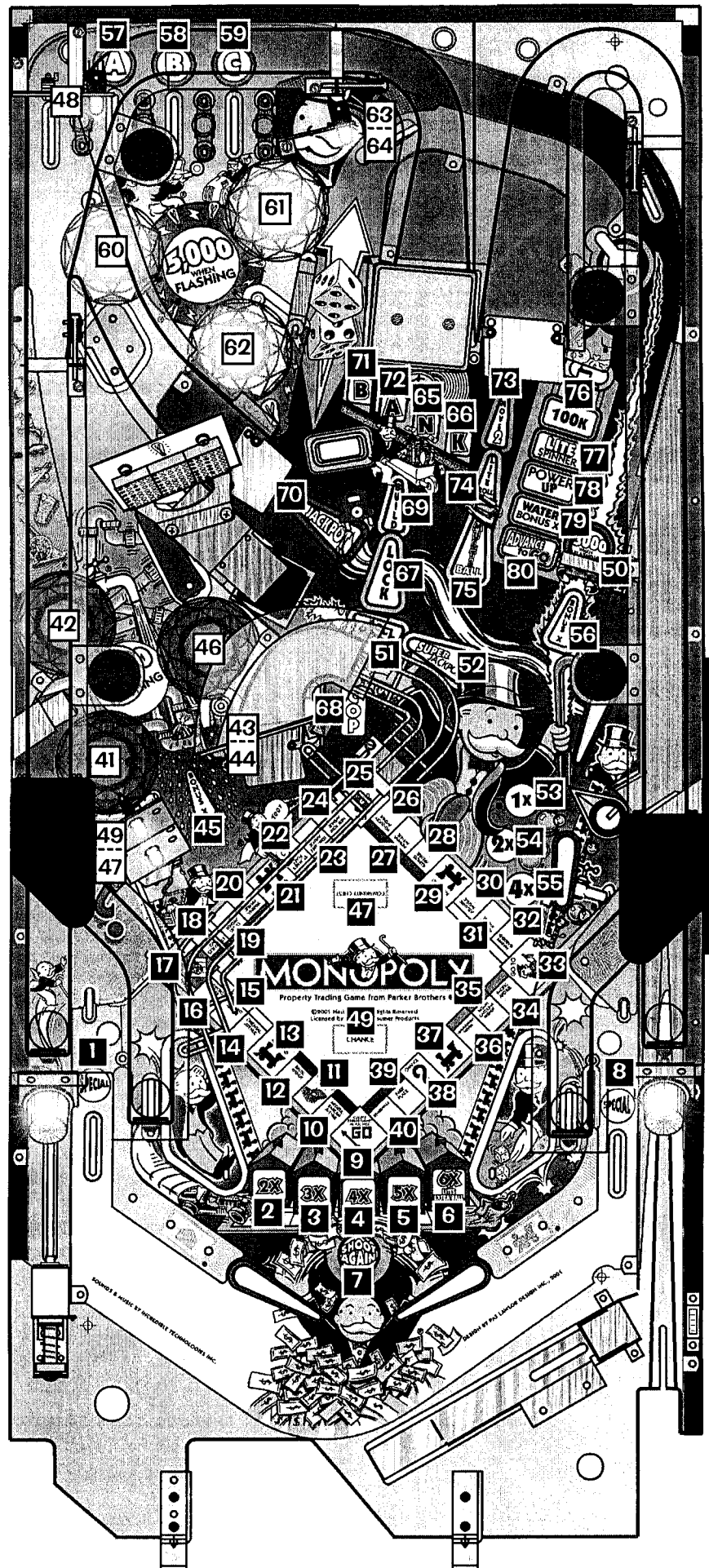

Sec. 3: ... Diag. Menu



Test Flash Lamps

From the **DIAGNOSTICS MENU**, select the "FLASH" *Icon* with either **Red "LEFT"** or **Green "RIGHT" Button** and press the **Black "ENTER" Button**. After selecting this *Icon* the display will indicate "CYCLING FLASHERS" and all the Flash Lamps will cycle continuously until the test is exited. This test is allows the technician to easily spot any burned-out bulbs and replace them. Flashers tested are Flash Lamps in Positions: **Q1-Q32** and in this game Flash Lamp(s) are in Position(s): **Q19-23 & Q29**.

Important: The **Power Interlock Switch** must be pulled out for this *test to function* while the **Coin Door** is **OPEN**.

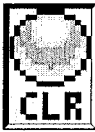

Clear Ball Trough

From the **DIAGNOSTICS MENU**, select the "CLR" *Icon* with either **Red "LEFT"** or **Green "RIGHT" Button** and press the **Black "ENTER" Button**. This is provided to allow the technician a simple method of removing the balls from the trough and also, to test functionality of the trough, ensuring proper trough operation. After selecting this *Icon* the display will show a graphic of the ball trough with balls in the trough with it's corresponding switch number. Select the "RUN" *Icon* to eject the ball in the first position. Simultaneously, the display and the playfield will eject the ball to the Trough Up-Kicker, eject from the Trough Up-Kicker into the Shooter Lane and will be ejected onto the playfield where the technician can easily retrieve the pinball or allow the ball(s) to re-enter the trough to continue Clear Ball Trough Test. **Important:** The **Power Interlock Switch** must be pulled out. **▲ Caution:** *Continuous use of above test may overheat the Trough Up-Kicker Coil.* **▲**



Technician Alerts

From the **DIAGNOSTICS MENU**, select the "TECH" *Icon* with either **Red "LEFT"** or **Green "RIGHT" Button** and press the **Black "ENTER" Button**. After selecting this *Icon* the display will indicate if there are any faulty switches (i.e., switches that are normally closed but remain open or open switches that have not been closed (activated) in 50 games.)



Service Phone

From the **DIAGNOSTICS MENU**, select the "SERV" *Icon* with either **Red "LEFT"** or **Green "RIGHT" Button** and press the **Black "ENTER" Button**. After selecting this *Icon* the display will indicate a phone number to call if technical assistance is required (*In USA code the number is 1-800-KICKERS*).



Begin Play Test

From the **DIAGNOSTICS MENU**, select the "PLAY" *Icon* with either **Red "LEFT"** or **Green "RIGHT" Button** and press the **Black "ENTER" Button**. After selecting this *Icon* the technician can test certain play functions to insure all switch activated coils function without entering game play. For example, by rolling the ball over the Shooter Lane switch, the Autoplunger should fire. If it kicks to early or too late, the switch actuator should be adjusted to compensate for this error. If it fails to fire, use the Switch Test or Coil Test to help determine the cause of the failure. During this function, similar tests may be performed on the "Ejects", Slingshots, Vertical Up-Kickers, Pop Bumpers, etc. in the game. For unique Play Test functions, select the "GAME SPECIFIC" *Icon* in the **DIAGNOSTICS MENU**. **Important:** The **Power Interlock Switch** must be pulled out.



Fire Kicker

From the **DIAGNOSTICS MENU**, select the "KNOCKER" *Icon* with either **Red "LEFT"** or **Green "RIGHT" Button** and press the **Black "ENTER" Button**. The digitally mastered "Knocker" is sounded.



Sound / Speaker Test

From the **DIAGNOSTICS MENU**, select the "SPKR" *Icon* with either **Red "LEFT"** or **Green "RIGHT" Button** and press the **Black "ENTER" Button**. The BSMT 2000 Sound System produces true digital stereo sound from Backbox & Cabinet Speakers or "Mono" on the Cabinet Speaker (when used by itself). After selecting this *Icon*, select the "-" or "+" *Icons* and press the **Black "ENTER" Button** to activate the first test. Repeat to visually see & hear all tests. Select the "RUN" *Icon* to activate the test chosen without moving to the next test.

Note: *During Sound Tests, the display shows the speaker identification and the corresponding sound(s). The sound functions allow verification that both channels are functioning properly & that the speaker connections are correct.*

Sound / Speaker Test Continued Next Page





Speaker Phase Testing

Connections to each of speakers are polarized and each must be connected appropriately for the best quality sound. If one speaker has the positive and negative connections reversed with respect to the other one, bass frequencies will not be produced properly and the overall sound quality will be poor. To test for proper speaker phasing, use the sound test to cycle through the Backbox & Cabinet, and Backbox Sine (repeated) functions. If the Cabinet Sine produces more volume and bass than the Left Sine, the speakers are connected properly. If it produces the same or less, one speaker is connected improperly. To isolate and correct reversed speaker connections, one of two methods may be used.

1. Check each speaker for polarity markings. If the speakers have polarity markings, verify that the Backbox Speaker RED-WHT Wire and the Cabinet Speaker YEL-WHT Wire is connected to the negative (-) terminal.
2. Disconnect the speaker output connector from the CPU / Sound Board and connect a 1.5-volt battery across each speaker pair one at a time while observing the speakers. Make sure the positive battery terminal is connected to the positive lead (CN4, Pin-3 (RED-BLK) or Pin-6 (YEL-BLK)) each time. As the connection is made, check speaker cone movement; proper connections are indicated by outward movement.

Auto / Manual Tests	Sounds Produced
Speaker Test	Tone
Sound/OPSYS EPROM (Loc. U7)	Level 1-3+ (Music Test)
Voice ROMs: 1 (U17) 2 (U21) 3 (U36) 4 (U37)	Speech Pattern 1-3+

Note: For ROM Locations, see Page DR. ①. For ROM Usage (Summary Table) see Page DR. ② in the "Find-It-In-Front: Dr. Pinball Section". Voice ROMs (U17, U21, U36 & U37) which are 8MB must have a Jumper at W6 on the CPU/Sound Board to function properly.



Begin Burn In

From the **DIAGNOSTICS MENU**, select the "BURN" *Icon* with either **Red "LEFT"** or **Green "RIGHT" Button** and press the **Black "ENTER" Button**. After selecting this *Icon* the Begin Burn-In Test will start. At this stage the game will exercise all CPU I/O Functions (Dot Matrix Display Test, Coil Testing, Lamp Testing, Sound, etc.). This is provided to constantly exercise sounds, coils, etc... Cumulative Burn-In minutes will be displayed. To reset Burn-In minutes to 00, select the "RESET" *Icon* in the **MAIN MENU** and select the "FACT" *Icon* (Factory Reset). See Chapter 5, Go To Reset Menu, of this section.



Dot Matrix Test

From the **DIAGNOSTICS MENU**, select the "DOT TEST" *Icon* with either **Red "LEFT"** or **Green "RIGHT" Button** and press the **Black "ENTER" Button**. After selecting this *Icon* the Dot Matrix Test immediately begins. The display will immediately illuminate & cycle for 1 pass of each test continuously for each of the following tests:

1. Illuminates 1 vertical column of dots, turning it off & illuminating the next column, until each column has been individually lit, while the other columns are off.
2. Illuminates 1 horizontal row of dots, turning it off & illuminating the next row, until each row has been individually lit, while the other rows are off.
3. Illuminates all the dots, except for one column from left to right.
4. Illuminates all the dots, except for one row from top to bottom.
5. Illuminates every other dot lit, in both the rows and columns.

Note: Pressing any button will exit the test & return to **DIAGNOSTICS MENU**.

Dot Matrix Display Explained

The display utilizes a Micro-Processor Control Board mounted in piggyback fashion to the Dot Matrix Display (128 X 32) Driver Board. The purpose behind this board is to provide more information to the operator as well as displaying graphics to the player.

The board is controlled by a 6809E Microprocessor and its personality ROM (Unique to the Game). It receives Data, Reset & Clock information from the CPU/Sound Board via the ribbon cable and sends back multiple Status and Busy Signals to the CPU. This is to insure synchronized communication between the CPU and the Display Controller Board. The Drivers for the rows and columns are provided on 5 surface mounted integrated circuits on the Dot Matrix Display Driver Board.

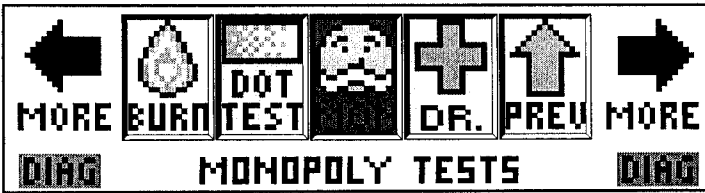

Monopoly Tests

To initiate, from the **DIAGNOSTICS MENU**, select the "MON" *Icon* with either the Red "LT" or Green "RT" **Button** (the **FLIPPER Buttons** operates in the same manner) & press the **Black "ENTER" Button** (the **START Button** operates in the same manner).

This will bring up the **MONOPOLY TESTS MENU**. This Sub-Menu is used to test the operation of the **Bank Door (Open & Close) Coils & OPTO Switches ("BNK" Icon)**, **Water Works Mini-Flipper & Water Works Motor Home Switch ("WTR" Icon) & Electric Company Sign Dot Test ("ELEC" Icon)**. To initiate, from the **MONOPOLY TESTS MENU**, select one of the 3 *Icons* with either the Red "LEFT" or Green "RIGHT" **Button** (the **LEFT and RIGHT FLIPPER Buttons** operates in the same manner) and press the **Black "ENTER" Button** (the **START Button** operates in the same manner). After finishing the Test, select the "PREV" *Icon* to return to the Sub-Menu or select either of the ">>" *Icons* to slip between the 3 Testing Menus. **CAUTION: Beware of MOVING PARTS!**

Important: The **Power Interlock Switch** must be pulled out for all tests to function while the **Coin Door is OPEN**.

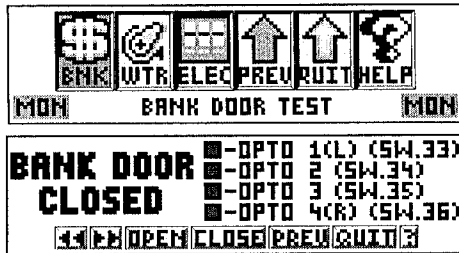

Bank Door Test

Selecting the "BNK" *Icon* will bring up the **BANK DOOR TEST MENU**. This test is provided to allow a method of testing the **Bank Close (Q6), Bank Open (Q13), and the Bank OPTO Switches (Sw. 33-36)**. Upon entering the test, the display will indicate the status of the Bank Door (the "CLOSE" *Mini-Icon* will be flashing). Select the "OPEN" *Mini-Icon* to **OPEN** the Bank Door (Q13 will be

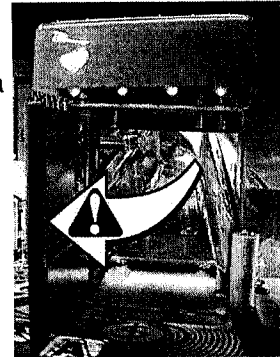

energized), the display will indicate **BANK DOOR OPEN**; select the "CLOSE" *Mini-Icon* to **CLOSE** the Bank Door (Q6 will be energized), the display will indicate **BANK DOOR CLOSED**. With *ball-in-hand*, roll a pinball into the Bank Door and watch the display. As the pinball breaks the OPTO beam at any of the 4 positions, the the solid box will turn .

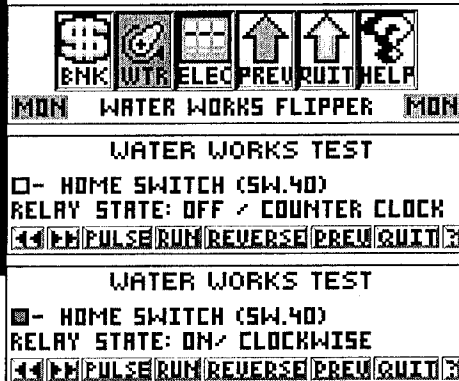

Water Works Flipper

Selecting the "WTR" *Icon* will bring up the **WATER WORKS FLIPPER TEST MENU**. This test is provided to allow a method of testing the **Water Works Motor (Q25) in conjunction with the Motor Relay Board (Q27) and the Water Works Motor Home Switch (Sw. 40)**. Upon entering the test, the display will indicate the status of the Relay Board (either **OFF/COUNTERCLOCKWISE** or **ON/CLOCKWISE**) and the **Motor Home Switch** (the "RUN" *Mini-Icon* will be flashing). Select the "REVERSE" *Mini-Icon* to change the direction of the Mini-Flipper (clockwise or counterclockwise); then select either the "RUN" or "PULSE" *Mini-Icons*. Activating the



"RUN" *Mini-Icon* will cycle the motor continuously until another *Mini-Icon* is selected or the test is exited. Activating the "PULSE" *Mini-Icon* will pulse the motor about 270°. Watch the display, as the Mini-Flipper is rotating the **Home Switch (Sw. 40)** will be closed (the box will turn solid) once every complete rotation.

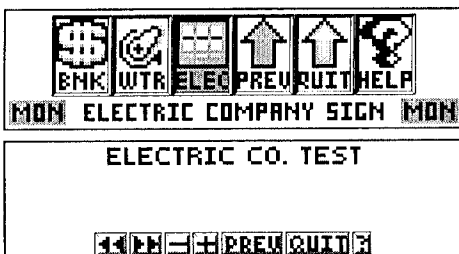

Electric Company Sign

Selecting the "ELEC" *Icon* will bring up the **ELECTRIC COMPANY SIGN TEST MENU**. This test is provided to allow a method of testing the triple 5X7 Dot Display on the **Electric Company Sign**. Upon entering the test, the display will indicate the status of the *Dot Display* which should be "off" or "blank" (the "+" *Mini-Icon* will be flashing). Select either the "-" or "+" *Mini-Icons* to step through

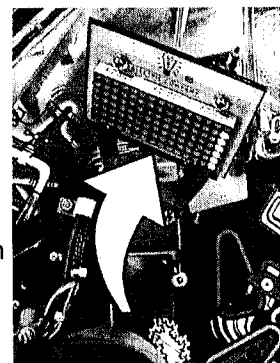

all six tests (as shown below). As each menu appears, the corresponding test is demonstrated on the **Electric Company Sign Dot Display**.

- | | | | | | |
|----|--|----|--|----|--|
| 1. | | 2. | | 3. | |
| 4. | | 5. | | 6. | |

NOTE:
For more details of the **PC Boards** which are tested on this page, see **Sec. 5, Chp. 4, Pages 130-133, Printed Circuit Boards (PCBs)**.



Sec. 3: ... Diag. Menu



Dr. Pinball (Flow Chart Menus)

To initiate, from the **DIAGNOSTICS MENU**, select the Cross "DR." *Icon* with either the **Red "LEFT"** or **Green "RIGHT" Button** and press the **Black "ENTER" Button**. This will bring you (the operator / technician) into **DR. PINBALL** (Flow Chart Menus) which offers you a choice of three sub-menus: Coil "DR.," Switch "DR." and Lamp "DR." *Icons*. Selecting a particular sub-menu will give you a choice of which specific Coil (any and all coil assemblies such as Flippers, VUKs, Magnets, etc.), Switch or Lamp circuit needs to be diagnosed. The display will now ask a question or give a procedure to follow such as "Does the lamp turn on?" or "Check bridge rectifier BR-20, if short replace." When Dr. Pinball asks a question or request a procedure the Dr. will expect a response such as "NO" or "YES" (see below examples of the *Mini-Icons* which will prompt the operator). You the operator/technician must respond by using your **Flipper Buttons** to "SELECT" a *Mini-Icon* and the **Start Button** to "ENTER" your selection.

The following are the *Mini-Icons* with explanations for the Dr. Pinball Sub-Menus to follow:



→ Select a Coil, Lamp or Switch to diagnose with "-" or "+" *Icon*; Then select the "RUN" *Icon* to activate the choice. "PREV" goes back to previous question. "QUIT" exits Portals completely. Help "?" gives direction on button usage.



→ Seen when a question is being asked on the Display. Select "YES" or "NO" to answer the question given. "END" lets you select a new item to test. "PREV", "QUIT" and "?" (see first example above).



→ Seen when diagnosis is given. Select any *Icon* for your next step. "END" lets you select a new item to test. "PREV", "QUIT" and "?" (see first example above).



→ In Coil Flow Chart Menu, select "PULSE" to pulse the coil selected. "END" lets you select a new item to test. "PREV", "QUIT" and "?" (see first example above).



Coil Flow Chart

To initiate, from the **DR. PINBALL MENU**, select the Coil "DR." *Icon* with either the **Red or Green Button** and press the **Black Button**. This is the Coil Flow Chart. Follow the questions, answering by using the *Mini-Icons* in the display.



Switch Flow Chart

To initiate, from the **DR. PINBALL MENU**, select the Switch "DR." *Icon* with either the **Red or Green Button** and press the **Black Button**. This is the Switch Flow Chart. Follow the questions, answering by using the *Mini-Icons* in the display.



Lamp Flow Chart

To initiate, from the **DR. PINBALL MENU**, select the Lamp "DR." *Icon* with either the **Red or Green Button** and press the **Black Button**. This is the Lamp Flow Chart. Follow the questions, answering by using the *Mini-Icons* in the display.

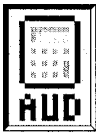

MONOPOLY

Pinball Game Audit Table

What's the current Replay Score Level?

CPU version: LOCATION: _____

DISPLAY ver.: DATE: ____/____/____

AUDITOR: _____

Copy for Field Audit Tracking Performance (Use blank boxes to fill-in Audit Information).



01
thru
12

Total Paid Credits	Average Ball Time	Coins Thru Left Slot	Coins Thru Center Slot	Total Coins	Meter Clicks
01: <input type="text"/>	03: <input type="text"/>	05: <input type="text"/>	07: <input type="text"/>	09: <input type="text"/>	11: <input type="text"/>
Free Game Percentage	Average Game Time	Coins Thru Right Slot	Coins Thru 4th Slot	Total Earnings	Software Meter
02: <input type="text"/>	04: <input type="text"/>	06: <input type="text"/>	08: <input type="text"/>	10: <input type="text"/>	12: <input type="text"/>



13
thru
55

Total Replays	Total Free Plays	15M+ Scores	Center Drains	Proprietary (46)	Right Flipper Used
18: <input type="text"/>	25: <input type="text"/>	32: <input type="text"/>	39: <input type="text"/>	<input type="text"/>	53: <input type="text"/>
Replay Percent	Total Plays	Average Scores	Right Drains	Proprietary (47)	Proprietary (54)
19: <input type="text"/>	26: <input type="text"/>	33: <input type="text"/>	40: <input type="text"/>	<input type="text"/>	<input type="text"/>
Total Balls Played	Total Specials	0 - 999K Scores	Service Credits	Slam Tilts	Proprietary (48)
13: <input type="text"/>	20: <input type="text"/>	27: <input type="text"/>	34: <input type="text"/>	41: <input type="text"/>	<input type="text"/>
Total Extra Balls	Special Percent	1M - 1.9M Scores	Ball Search Started	Total Balls Saved	Proprietary (49)
14: <input type="text"/>	21: <input type="text"/>	28: <input type="text"/>	35: <input type="text"/>	42: <input type="text"/>	<input type="text"/>
Extra Ball Percent	Total Matches	2M - 4.9M Scores	Lost Ball Feeds	Proprietary (43)	Proprietary (50)
15: <input type="text"/>	22: <input type="text"/>	29: <input type="text"/>	36: <input type="text"/>	<input type="text"/>	<input type="text"/>
Replay 1 Awards	High Score Awards	5M - 9.9M Scores	Lost Ball Game Starts	Proprietary (44)	Proprietary (51)
16: <input type="text"/>	23: <input type="text"/>	30: <input type="text"/>	37: <input type="text"/>	<input type="text"/>	<input type="text"/>
Replay 2+ Awards	High Score Percent	10M - 14.9M Scores	Left Drains	Proprietary (45)	Left Flipper Used
17: <input type="text"/>	24: <input type="text"/>	31: <input type="text"/>	38: <input type="text"/>	<input type="text"/>	52: <input type="text"/>



56
thru
110

Cash Grab Award	Bonus X	Inlanes Completed	Card - WW Mult	Card - Bonus	Yellow - Overload
63: <input type="text"/>	72: <input type="text"/>	81: <input type="text"/>	90: <input type="text"/>	99: <input type="text"/>	108: <input type="text"/>
Waterworks Arrive	Dice Rolls	Land Grab Start	Card - Bonus X	Card - Pay Each	Green - Millions
64: <input type="text"/>	73: <input type="text"/>	82: <input type="text"/>	91: <input type="text"/>	100: <input type="text"/>	109: <input type="text"/>
Multiball Qualify	Electric Co Power	Left Ramp	Land Grab Houses	Card - Upper Pops	Card - Quick MB
56: <input type="text"/>	65: <input type="text"/>	74: <input type="text"/>	83: <input type="text"/>	92: <input type="text"/>	101: <input type="text"/>
Multiball Start	MB Rematch Offer	Right Ramp	Card - Light Lock	Card - Lower Pops	Card - Cash Grab
57: <input type="text"/>	66: <input type="text"/>	75: <input type="text"/>	84: <input type="text"/>	93: <input type="text"/>	102: <input type="text"/>
Quick MB Starts	MB Rematch Given	Side Ramp	Card - EB Lit	Card - All Pops	Purple - Pops
58: <input type="text"/>	67: <input type="text"/>	76: <input type="text"/>	85: <input type="text"/>	94: <input type="text"/>	103: <input type="text"/>
2+ MBall Starts	Chance/Chest Cards	Free Parking	Card - Adv RR	Card - Adv Bank	Lt Blu - Token Race
59: <input type="text"/>	68: <input type="text"/>	77: <input type="text"/>	86: <input type="text"/>	95: <input type="text"/>	104: <input type="text"/>
Jackpots	Bank Hits	Left Orbit	Card - Special Lit	Card - Roll Lit	Magenta - Free Money
60: <input type="text"/>	69: <input type="text"/>	78: <input type="text"/>	87: <input type="text"/>	96: <input type="text"/>	105: <input type="text"/>
Super Jackpots	Banks Completed	Right Orbit	Card - Property	Card - MB Lit	Orange - Tax Refund
61: <input type="text"/>	70: <input type="text"/>	79: <input type="text"/>	88: <input type="text"/>	97: <input type="text"/>	106: <input type="text"/>
Cash Grab Start	Right Standups	Railroad Ramps	Card - Points	Card - 3 Spaces	Red - Board Chase
62: <input type="text"/>	71: <input type="text"/>	80: <input type="text"/>	89: <input type="text"/>	98: <input type="text"/>	107: <input type="text"/>

Don't forget to fill-in the current Replay Score Level in the Box at the top of this page and current versions...

Comments:



Section 3, Chapter 3:
Go To Audits Menu

Go To Audits Menu

Overview

The **Portals™ Service Menu System** provides 110 Audit Functions for accounting purposes and for evaluation of *Game Difficulty Adjustments*. The Audit Functions are divided into 3 groups: • **Earnings (Coin) Audits**, are the first 12 most-used Audits • **S.P.I. Audits**, are the Game Play Generic Audits 13-55 • **MONOPOLY® Audits**, are the Game Play Specific Audits 56-110 (**//// Programming Use Only ////**); Audits left open (blank space in gray, e.g. Audits 43-51, 54 & 55) are currently **Not Used**, allowing for **Future Expansion**, if any, or are **Proprietary**. If the code version is upgraded, view Audits in the display & write the audit(s) in the blank(s) if any audit(s) were added. Each group may be viewed in the **Portals™ Service Menu** (see Chapter 1, **Portals™ Service Menu Introduction**, of this Section). View all audits with the **Game Audit Table** provided on the previous page.



GO TO AUDITS MENU

With the game in the Attract Mode, open the Coin Door and press the **Black "BEGIN TEST" Button**. Select the "AUD" *Icon* in the **MAIN MENU** with either **Red "LEFT"** or **Green "RIGHT" Button** and press the **Black "ENTER" Button**. The **AUDITS MENU** appears.

Important Notes:



Exit any sub-menu and return to the **MAIN MENU** by selecting & activating the "PREV" *Icons*. If no *Icons* appear in the display because of a testing function or special display (e.g. "Help"), press any button to exit.



Selecting & activating the "QUIT" *Icon* from any display will exit the Service Session.



Selecting & activating the "HELP" *Icon* from any display will show a help screen. (An explanation of each *Mini-Icon* at that level will cycle continuously until any active button is pressed.)



Selecting & activating the "ARROW" *Icons* selects the next or previous audit in the group.



Earnings Audits (1-12)

From the **AUDITS MENU**, select the "EARN" *Icon* with either **Red "LEFT"** or **Green "RIGHT" Button** and press the **Black "ENTER" Button**. Select and activate the "RIGHT ARROW" *Icon* to view the 1st audit in this group. Continue to select either of the "ARROW" *Icons* to view each audit one at a time. The display will describe the audit number, the audit name, and the audit total or value. The current audit will remain in the display until the next audit is chosen or when the sub-menu is exited.

Au. Nº	Audit Name	Audit Definition
Au. 1	TOTAL PAID CREDITS	Provides the total number of paid credits.
Au. 2	FREE GAME PERCENTAGE	This percentage is derived from dividing Audit 25, Total Free Plays, by Audit 26, Total Plays.
Au. 3	AVERAGE BALL TIME	In seconds, the average ball time is derived from the total play time divided by Audit 13, Total Balls Played.
Au. 4	AVERAGE GAME TIME	The average game time is expressed in minutes and seconds.
Au. 5	COINS THRU LEFT SLOT	Provides the total number of times Coin Switch (Sw. 6) was closed.
Au. 6	COINS THRU RIGHT SLOT	Provides the total number of times Coin Switch (Sw. 4) was closed.
Au. 7	COINS THRU CENTER SLOT	Provides the total number of times Coin Switch (Sw. 5) was closed.
Au. 8	COINS THRU 4TH SLOT	Provides the total number of times Coin Switch (Sw. 2) was closed.
Au. 9	TOTAL COINS	Provides the total amount of coins registered through all the slots.
Au. 10	TOTAL EARNINGS	The total cash value accumulated since the last <i>Factory Restore</i> occurred (see Chapter 5, Go to Reset Menu, of this section).
Au. 11	METER CLICKS	Provides the total number of money clicks accumulated. (Based on the country's lowest coin denomination used for the game credit.)
Au. 12	SOFTWARE METER	Provides the continuing total of Meter Clicks. This audit cannot be reset; the display shows the constant addition of Meter Clicks.





S.P.I. Audits (13-55)

From the **AUDITS MENU**, select the "S.P.I." *Icon* with either **Red "LEFT"** or **Green "RIGHT" Button** and press the **Black "ENTER" Button**. Select and activate the "RIGHT ARROW" *Icon* to view the 1st audit in this group. Continue to select either of the "ARROW" *Icons* to view each audit one at a time. The display will describe the audit number, the audit name, and the audit total or value. The current audit will remain in the display until the next audit is chosen or when the sub-menu is exited.

Au. N°	Audit Name	Audit Definition
Au. 13	TOTAL BALLS PLAYED	Provides the total number of regular and extra balls.
Au. 14	TOTAL EXTRA BALLS	Provides the total number of extra balls awarded.
Au. 15	EXTRA BALLS PERCENT	Provides the percentage total from dividing Audit 14, Total Extra Balls, by Audit 26, Total Plays.
Au. 16	REPLAY 1 AWARDS	Provides the total awards (Credit, Extra Ball, Or Audit) for level 1.
Au. 17	REPLAY 2+ AWARDS	Provides the total awards (Credit, Extra Ball, Or Audit) for level(s) 2 or higher.
Au. 18	TOTAL REPLAYS	Provides the total awards (Credits, Extra Balls, Or Audit Only) for exceeding replay score levels.
Au. 19	REPLAY PERCENT	Provides the percentage total from dividing Audit 18, Total Replays, by Audit 26, Total Plays. The percentage reflects replay total awards for exceeding replay score levels.
Au. 20	TOTAL SPECIALS	Provides the total awards (Credits, Extra Balls, Or Scores) for making specials.
Au. 21	SPECIAL PERCENT	This percentage is derived from dividing Audit 20, Total Specials, by Audit 26, Total Plays.
Au. 22	TOTAL MATCHES	Provides the total credits awarded for matching the last two digits of the score with the system-generated Match Number at the end of the game. Percentage of match credits is adjustable from 0% to 10% by Adjustment 11, Match Percentage, if enabled. (See Chapter 4, Go to Adjustments Menu, of this section.)
Au. 23	HIGH SCORE AWARDS	Provides the total credits awarded for exceeding the High-Score-To-Date scores.
Au. 24	HIGH SCORE PERCENT	This percentage is derived from dividing Audit 23, High Score Awards, by Audit 26, Total Plays.
Au. 25	TOTAL FREE PLAYS	Provides the total free credits for replays, High-Score-To-Date, Specials, and Match.
Au. 26	TOTAL PLAYS	This total is derived by adding the sum of Audit 1, Total Paid Credits, and Audit 25, Total Free Plays. Note that free credits are not recorded in the Audit until they are actually used.
Au. 27	0 - 999K SCORES	Provides the total number of games the Player's final score was between 0 and 999,990 points.
Au. 28	1M - 1.9M SCORES	Provides the total number of games the Player's final score was between 1,000,000 and 1,999,990 points.
Au. 29	2M - 4.9M SCORES	Provides the total number of games the Player's final score was between 2,000,000 and 4,999,990 points.
Au. 30	5M - 9.9M SCORES	Provides the total number of games the Player's final score was between 5,000,000 and 9,999,990 points.
Au. 31	10M - 14.9M SCORES	Provides the total number of games the Player's final score was between 10,000,000 and 14,999,990 points.
Au. 32	15M+ SCORES	Provides the total number of games the Player's final score was over 15,000,000 points.
Au. 33	AVERAGE SCORES	This total is derived from adding the Final Score of each game to a table and dividing this sum by Audit 26, Total Plays.
Au. 34	SERVICE CREDITS	Provides the total number of times Dedicated Switch (DS-7) was closed, not in the Portals™ Service Menu. (See Chapter 1, Introduction [Access & Use] for instructions on how to receive Service Credits.)
Au. 35	BALL SEARCH STARTED	Provides the total number of times the game performed a ball search.
Au. 36	LOST BALL FEEDS	Provides the total number of times the game added a ball to play when it could not find a ball after ball search.

Sec. 3: ...Audits Menu





S.P.I. Audits Continued.

Audit Name	Audit Definition
Au. 37 LOST BALL GAME STARTS	Provides the total number of times the game started with a ball missing from the ball trough at the start of a game.
Au. 38 LEFT DRAINS	Provides the total number of times Rollover Switch 57 was closed.
Au. 39 CENTER DRAINS	Provides the total number of times the game ball had drained with the last switch closed was not Sw. 57 or Sw. 60.
Au. 40 RIGHT DRAINS	Provides the total number of times Rollover Switch 60 was closed.
Au. 41 SLAMTILTS	Provides the total number of times Contact Switch 55 was closed.
Au. 42 TOTAL BALLS SAVED	Provides the total number of times this feature was used. This feature is enabled at the start of each ball and is disabled as soon as the ball makes contact with 5 game switches or allocated time expired.
Au. 43- Au. 51	These audits are Not Used , allowing for Future Expansion , if any, and/or Proprietary (used for programming).
Au. 52 LEFT FLIPPER USED	Provides the total number of times Dedicated Sw. (DS-1) was closed.
Au. 53 RIGHT FLIPPER USED	Provides the total number of times Dedicated Sw. (DS-3) was closed.
Au. 54- Au. 55	These audits are Not Used , allowing for Future Expansion , if any, and/or Proprietary (used for programming).



Monopoly Audits (56-110)

From the **AUDITS MENU**, select the "MON" *Icon* with either **Red "LEFT"** or **Green "RIGHT" Button** and press the **Black "ENTER" Button**. Select and activate the "RIGHT ARROW" *Icon* to view the 1st audit in this group. Continue to select either of the "ARROW" *Icons* to view each audit one at a time. The display will describe the audit number, the audit name, and the audit total or value. The current audit will remain in the display until the next audit is chosen or when the sub-menu is exited. These Game Specific Audits are primarily used for programming. They provide the total number of times a feature was started, awarded, lit, played and/or completed. They also may indicate the total number of Switch Closures during certain modes or features. Multiple variations of switch closures (see Diagnostics) are used to determine the lighting and/or completion of the feature stated.



Au. Nº	Audit Name	Au. Nº	Audit Name
Au. 56	Multiball Qualify	Au. 77	Free Parking
Au. 57	Multiball Start	Au. 78	Left Orbit
Au. 58	Quick MB Starts	Au. 79	Right Orbit
Au. 59	2+ MBall Starts	Au. 80	Railroad Ramps
Au. 60	Jackpots	Au. 81	Inlanes Completed
Au. 61	Super Jackpots	Au. 82	Land Grab Start
Au. 62	Cash Grab Start	Au. 83	Land Grab Houses
Au. 63	Cash Grab Award	Au. 84	Card - Light Lock
Au. 64	Waterworks Arrive	Au. 85	Card - EB Lit
Au. 65	Electric Co Power	Au. 86	Card - Adv RR
Au. 66	MB Rematch Offer	Au. 87	Card - Special Lit
Au. 67	MB Rematch Given	Au. 88	Card - Property
Au. 68	Chance/Chest Cards	Au. 89	Card - Points
Au. 69	Bank Hits	Au. 90	Card - WW Mult
Au. 70	Banks Completed	Au. 91	Card - Bonus X
Au. 71	Right Standups	Au. 92	Card - Upper Pops
Au. 72	Bonus X	Au. 93	Card - Lower Pops
Au. 73	Dice Rolls	Au. 94	Card - All Pops
Au. 74	Left Ramp	Au. 95	Card - Adv Bank
Au. 75	Right Ramp	Au. 96	Card - Roll Lit
Au. 76	Side Ramp	Au. 97	Card - MB Lit

Sec. 3: ...Audits Menu





MONOPOLY® Audits Continued. /// Programming Use Only ///

Audit Name	Au. Nº	Audit Name
------------	--------	------------

Au. 98	Card - 3 Spaces	Au. 105	Magenta - Free Money
Au. 99	Card - Bonus	Au. 106	Orange - Tax Refund
Au. 100	Card - Pay Each	Au. 107	Red - Board Chase
Au. 101	Card - Quick MB	Au. 108	Yellow - Overload
Au. 102	Card - Cash Grab	Au. 109	Green - Millions
Au. 103	Purple - Pops	Au. 110	Dk Blu - EB/Special
Au. 104	Lt Blu - Token Race		

Sec. 3: ...Audits Menu





Go To Printer Menu

From the **AUDITS MENU**, select the "PRNT" *Icon* with either **Red "LEFT"** or **Green "RIGHT"** **Button** and press the **Black "ENTER"** **Button**. The **PRINTER MENU** appears.

Special equipment is required for this Sub-Menu

The **Portals™ Service Menu System** provides 3 Audit Printing Adjustment Functions to print information on a "Hand-Held" printer, download game information to a Laptop PC or clear the printout count. A printer interface board, hand-held printer and/or a special software program is required to run this menu. Entering this menu and selection/activation of the *Icons* without this equipment/software will not affect the game.



Quick Printout (Printer Interface)

From the **PRINTER MENU**, select the "QUIK" *Icon* with either **Red** or **Green Button** and press the **Black Button**. Select the "+" *Icon* and press the **Black Button** to start the printout. Only the Earnings Audits can be printed out to a "Hand-Held" Printer.



Full Printout (Alison Interface Program)

From the **PRINTER MENU**, select the "ALISON" *Icon* with either **Red** or **Green Button** and press the **Black Button**. Select the "+" *Icon* and press the **Black Button** to start the download. A special software program & a Lap Top PC is required. All game audits (Earnings, S.P.I. & Game Specific) can be retrieved.



Reset Printer (N° of Copies Printed Reset)

From the **PRINTER MENU**, select the "RESET" *Icon* with either **Red** or **Green Button** and press the **Black Button**. Select the "+" *Icon* and press the **Black Button** to start the clear the "N° of copies printed" count total.

RESETTING AUDIT NOTES:



Audit Note: 1st Way to Reset Audits

To reset audits, from the **MAIN MENU**, select the "ADJ" *Icon*. See Chapter 4, Go to Adjustments Menu, of this section.



Select the "S.P.I." *Icon*, from the **ADJUSTMENT MENU**, and advance to Adj. 8, Reset Coin Audits, with the "RIGHT ARROW" *Icon*. Select the "+" *Icon* to change setting to **YES**. When enabled, the *Coin Audits* (5-11) will be reset to zero. Advance to Adj. 9, Reset Game Audits, with the "RIGHT ARROW" *Icon*. Select the "+" *Icon* to change setting to **YES**. When enabled, *all the audits* will be reset to zero, **except** for the *Coin Audits* (5-11) **and** Audit 12, Software Meter (the only audit which cannot be reset to zero).



Audit Note: 2nd Way to Reset Audits

To reset audits, from the **MAIN MENU**, select the "RESET" *Icon*. See Chapter 5, Go to Reset Menu, of this section.



Selection of the "COIN" *Icon*, from the **RESET MENU**, will reset the *Coin Audits* (5-11) to zero.



Selection of the "AUD" *Icon*, from the **RESET MENU**, will reset all audits to zero, **except** for the *Coin Audits* (5-11) **and** Audit 12, Software Meter (the only audit which cannot be reset to zero).



Pinball Game Adjustment Table

Some adjustments have a "Drop-Down" Table for further customization.



S.P.I. Adjustments 1-45

Adjustment Name

USA Default

Your Setting

Adjustment Name

USA Default

Your Setting

1	REPLAYS: FIXED/AUTO ‡	...12%...*		23	DEFAULT HIGH SCORE #3	22,000,000	
2	REPLAY LEVELS ‡	1 ...		24	DEFAULT HIGH SCORE #4	20,500,000	
3	REPLAY AWARD	CREDIT		25	DEFAULT HIGH SCORE #5	18,000,000	
4	FREE GAME LIMIT	05		26	DEFAULT HIGH SCORE #6	16,500,000	
5	EXTRA BALL LIMIT	03		27	DEFAULT HIGH SCORE #7	12,000,000	
6	GAME DIFFICULTY ‡	MODERATE		28	DEFAULT HIGH SCORE #8	10,500,000	
7	GAME PRICING ‡	USA5		29	DEFAULT HIGH SCORE #9	8,000,000	
8	RESET COIN AUDITS	NO		30	DEFAULT HIGH SCORE #10	6,500,000	
9	RESET GAME AUDITS	NO		31	HSTD RESET COUNT	2,000	
10	RESET HIGH SCORES	NO		32	HIGH SCORE INITIALS	3 Initials	
11	MATCH PERCENTAGE	8%*		33	FREE PLAY	NO	
12	BALLS PER GAME	03		34	CUSTOM MESSAGE	ON	
13	TILT WARNINGS	01		35	FLASH LAMP POWER	NORMAL	
14	REPLAY BOOST	YES		36	COIL PULSE POWER	NORMAL	
15	CREDIT LIMIT	30		37	KNOCKER VOLUME	LOW	
16	ALLOW HIGH SCORES	YES		38	GAME RESTART	YES	
17	HIGH SCORE #1 AWARDS	01		39	EXTRA BALL PERCENTAGE	20%*	
18	HIGH SCORE #2 AWARDS	01		40	BILL VALIDATOR	NO	
19	HIGH SCORE #3 AWARDS	01		41	TOURNAMENT MODE	NONE	
20	HIGH SCORE #4 AWARDS	00		42	UK COIN MECH. TYPE	CURRENT:	
21	DEFAULT HIGH SCORE #1	30,000,000		43	BKGRND MUSIC VOLUME	01	
22	DEFAULT HIGH SCORE #2	26,000,000		44	LOCATION ID	00	
				45	GAME ID	00	

Sec. 3: ... Adj. Menu

PLEASE NOTE: All Factory Settings (Defaults) described in the tables above/below and within the Adjustment Definitions are for USA Settings only (CPU/Snd Bd. Dip Sw. 300 Settings 1-8 are all "OFF"). Different countries may have different Factory Settings (Defaults). ‡ Adj. 1, 2, 6 & 7 have "Drop-Down" Tables, see definitions.

Adj. 42 & 48 are utilized only for the UK, with UK Dip Switch Option Setting 2 (See DR. 6, in the front part of this manual.)

* - may change.



MONOPOLY® Adjustments 46-63

Adjustment Name

USA Default

Your Setting

Adjustment Name

USA Default

Your Setting

46	EXTRA BALL MEMORY	NO		55	ELECTRIC CO DIFF	MODERATE	
47	SPECIAL MEMORY	YES		56	B-A-N-K LETTERS	01	
48	UK POST SAVE ENABLED	NO		57	CHASE BALL	YES	
49	FREEZE TIME	OFF		58	POP HITS TO MOVE TOKEN	05	
50	BANK DIFFICULTY	MODERATE		59	ADV BANK AT NEW BALL	YES	
51	REMATCH DIFFICULTY	MODERATE		60	RIGHT STANDUP SPOTS	03	
52	BONUS X DIFFICULTY	MODERATE		61	CHANCE VUK STRENGTH	MODERATE	
53	DISABLE BANK	NO		62	START AT 1500 PTS	YES	
54	TIMED PLUNGER	OFF		63	ELEC. EB AT %	30	



Section 3, Chapter 4:
Go To Adjustments Menu

Go To Adjustments Menu

Overview

The **Portals™ Service Menu System** provides **63** Adjustment Functions to vary game difficulty or to customize (e.g. Adjusting: High Score Levels; Balls per game; Game Pricing; Default High Scores; etc.). The Adjustment Functions are divided into 2 groups: • **S.P.I. Adjustments**, are the Game Play Generic Adjustments (1-45) • **MONOPOLY® Adjustments**, are the Game Play Specific Adjustments (46-63); Any Adjustment(s) left open or are currently *Not Used*, are allowing for Future Expansion, if any, or are Proprietary. If the code version is upgraded, view Adjustments in the display & write the adjustment(s) in the blank(s) if any adjustment(s) were added. Each group may be viewed manually after entering the **Portals™ Service Menu** (see Chapter 1, **Portals™ Service Menu Introduction**, of this Section). All adjustments can be viewed at a glance with the **Game Adjustment Table** provided on the previous page. If a value is changed, the display will indicate **REQUEST INSTALLED**.

Important: The **Coin Door** must be **OPEN** allowing the **Memory Protect Switch** to be disabled so changes can be made.



GO TO ADJUSTMENTS MENU

With the game in the Attract Mode, open the Coin Door and press the **Black "BEGIN TEST" Button**. Select the "ADJ" *Icon* in the **MAIN MENU** with either **Red "LEFT"** or **Green "RIGHT"** Button and press the **Black "ENTER" Button**. The **ADJUSTMENTS MENU** appears.

Important Notes:



Exit any sub-menu and return to the **MAIN MENU** by selecting & activating the "PREV" *Icons*. If no *Icons* appear in the display because of a testing function or special display (e.g. "Help"), press any button to exit.



Selecting & activating the "QUIT" *Icon* from any display will exit the Service Session.



Selecting & activating the "HELP" *Icon* from any display will show a help screen. (An explanation of each *Mini-Icon* at that level will cycle continuously until any active button is pressed.)



In Adjustments, selecting & activating the "-" *Icon* decrements the value setting. Selecting & activating the "+" *Icon* increments the value setting.



Selecting & activating the "ARROW" *Icons* selects the next or previous adj. in the group.



S.P.I. Adjustments (1-45)

From the **ADJUSTMENTS MENU**, select the "S.P.I." *Icon* with either **Red "LEFT"** or **Green "RIGHT" Button** and press the **Black "ENTER" Button**. Select and activate the "RIGHT ARROW" *Icon* to view the 1st adjustment in this group. Continue to select either of the "ARROW" *Icons* to view each adjustment one at a time. Select either the "-" or "+" *Icons* to change the value, if desired. The display will describe the adjustment number, the adjustment name, and the adjustment total or value. The current adjustment will remain in the display until the next adjustment is chosen or when the sub-menu is exited.

Adj. Nº	Adjustment Name	Adjustment Definition
Adj. 1	REPLAYS: FIXED / AUTO	Set between 01% - 50% and Fixed (0%) for Replay Levels. Default is 12% . Four levels may be selected. Adjustments allow awarding of a credit or an extra ball as each level is exceeded. With the Autopercentage Feature , if the actual replay percentage is higher or lower than that desired, the game will automatically adjust for the new recommended percentage score(s).
Adj. 2	REPLAY LEVELS	Set between 1 - 4 or NONE for the number of replay levels to be active. A "Drop-Down" Table appears (after selection of number of replay levels) showing Replay Level 1. Adjust Replay Level 1 between 10M - 9.99B . Adjust Replay Level 2, 3 and/or 4 respectively.
Adj. 3	REPLAY AWARD	Set for replays to award: CREDIT, EXTRA BALL, NONE or SPECIAL (When score threshold is achieved, a Playfield Special is lit.) Default is CREDIT .
Adj. 4	FREE GAME LIMIT	Set between 01 - 09 or NO FREE GAMES . Default is 05 . Adjust the maximum number of <i>Free Games</i> that may be accumulated per game.
Adj. 5	EXTRA BALL LIMIT	Set between 01 - 09 or NO EXTRA BALLS . Default is 03 . Adjust the maximum number of <i>Extra Balls</i> that may be accumulated per game.





S.P.I. Adjustments Continued.

Adjustment Name	Adjustment Definition
-----------------	-----------------------

Adj. 6 GAME DIFFICULTY

Set to **EXTRA EASY, EASY, MODERATE, HARD** or **EXTRA HARD**. (Note: Additional game features which are not adjusted may also change when adjusting this adjustment; see below table.) Default is **MODERATE**. Any one of the **INSTALL** settings (in a "Drop-Down" Table) for this adjustment may be activated to automatically select settings for multiple adjustments affecting game difficulty. Select and activate the "-" or "+" icons to choose the difficulty level required. After activation, the individual adjustments may be readjusted, if desired. Adjustments which typically automatically get changed when changing this adjustment are Game Specific with adjustments values of **EXTRA EASY, EASY, MODERATE, HARD, EXTRA HARD, ON** or **OFF**. After changing this adjustment, make note of it in the Table on Page 34 (in pencil), and check all Game Specific adjustments, noting all changes in the "Your Setting" Column. *Performing a Factory Reset will revert all adjustments back to the defaults.*

Play Rules: Novelty & 4-Ball, plus Add-A-Ball Settings

The following three combinations are recommended for situations where local laws restrict certain game features regarding the use of replays or the number of balls per game:

Novelty Play Rules - Set to establish recommended settings for no Free Play or Extra Balls:

Adj.	Adjustment Name	Setting	Adj.	Adjustment Name	Setting
1	Replays: Fixed/Auto	Fixed	5	Extra Ball Limit	00
2	Replay Levels	None	11	Match Percentage	Off
3	Replay Award	None	17	High Score #1 Awards	1
4	Free Game Limit	0	18	High Score #2 Awards	0

4-Ball Play Rules - Set to establish recommended settings for 4-Ball Play:

Adj.	Adjustment Name	Setting	Adj.	Adjustment Name	Setting
1	Replays: Fixed/Auto	07%	5	Extra Ball Limit	3
2	Replay Levels	1	11	Match Percentage	4
3	Replay Award	Credit	12	Balls Per Game	5
4	Free Game Limit	5	17	High Score #1 Awards	1
			18	High Score #2 Awards	0

Add-A-Ball Settings -To disable awarding of credits and provide awards with an Extra Ball:

Adj.	Adjustment Name	Setting	Adj.	Adjustment Name	Setting
3	Replay Award	Extra Ball	16	Allow High Scores	No
4	Free Game Limit	00	17-20	High Score #1 - #4 Awards	0
11	Match Percentage	Off			

Sec. 3: ... Adj. Menu

Set between **USA1** thru **UK6** or **CUSTOM**. Default is **USA5** (foreign Game Pricing Options are in the Standard Pricing Select Table on the following pages). There are two methods available for coin switch programming: Standard & Custom. Standard pricing uses a single adjustment as seen in the first display. See the Standard Pricing Table. If "Custom" is selected, a "Drop-Down" Table appears. Select a pricing scheme shown in the Custom Pricing Table as seen below.

Adj. 7 GAME PRICING

With Adjustment 7 set to **CUSTOM** operating the **Black "Enter" Button** again initiates a drop down menu representing coin switch pulses for the LEFT, CENTER, RIGHT and 4TH Coin Slots. The prescribed the number of pulses are required for 1 Credit. For example, if *Left Coin Pulses*, was set to 02 and *Coin Switch Pulses Required for 1 Credit*, to 01 a coin in the Left Slot would produce 2 Credits. Further, if *Left Coin Pulses*, was set to 01 and *Coin Switch Pulses Required for 1 Credit*, to 02, 2 Coins in the Left Slot would be required for 1 Credit.

Coin Switch Pulses Required for Bonus Credit may be set to post bonus credits when a minimum amount of coins are inserted at one time. For example, if *Left Coin Pulses* was set to 01, *Coin Switch Pulses Required for 1 Credit* to 01 and *Coin Switch Pulses Required for Bonus Credit* to 04, 1 Credit would be posted for each of the first 3 Coins in the Left Slot and 2 Credits for the 4th Coin.

S.P.I. Adjustment 7 Continues on the next page.





S.P.I. Adjustment 7 Continued.

Standard/Custom Pricing - Set for the desired pricing scheme from the Standard Pricing Table as indicated on the Dot Matrix Display. For Custom Pricing, set to **CUSTOM**. When set to **CUSTOM**, the following adjustments are utilized to tailor each individual coin chute:

Left Coin Switch Pulses	Set the number of pulses registered for closure of the Left Coin Switch; 00 to 99 .
Right Coin Switch Pulses	Set the number of pulses registered for closure of the Right Coin Switch; 00 to 99 .
Center Coin Switch Pulses	Set the number of pulses registered for closure of the Center Coin Switch; 00 to 99 .
4th Coin Switch Pulses	Set the number of pulses registered for closure of the Fourth Coin Switch; 00 to 99 .
Coin Switch Pulses Required for 1 Credit	Set the number of pulses required to post one credit; 00 to 99 .
Coin Switch Pulses Required for Bonus Credit	Set the number of pulses required to award the 1st Bonus credit(s); 00 to 99 .
Coin Sw. Pulses Req. for 2nd Bonus Credit	Set the number of pulses required to award the 2nd Bonus credit; 00 to 99 .
Credits awarded for 1st Bonus	Set the number of credits awarded for achieving the first Bonus level; 00 to 99 .

Custom Pricing Table

Coin Mechanisms				<<< Adjustments >>>									
LEFT	CENTER	RIGHT	4TH	Plays/Coins	LEFT Pulses	CENTER Pulses	RIGHT Pulses	4TH Pulses	Pulses /Credit	Pulses /Bonus	Pulses /2nd Bonus	Credit /1st Bonus	
25¢	\$1.00	25¢	N/U	1/25¢ 3/50¢	01	04	01	00	01	02	00	01	
				1/25¢ 5/\$1.00	01	04	01	00	01	04	00	01	
				1/25¢ 6/\$1.00	05	20	05	00	04	20	00	01	
5SCH	10SCH	10SCH	N/U	1/10 S	01	02	02	00	02	00	00	00	
				1/10 S 4/30 S	04	08	08	00	06	00	00	00	
10p	50p	£1	20p	1/30p 2/50p 5/£1	01	06	15	02	03	00	00	00	
				1/50p 3/£1	01	05	15	02	05	00	00	00	
				1/30p 4/£1	01	05	12	02	03	00	00	00	
20¢	N/U	\$1.00	N/U	1/60¢ 2/\$1.00	01	00	05	00	03	05	00	01	

Below and the following page is the **Standard Pricing Select Table** for the individual countries listed. The *Pricing Scheme* is determined in two ways - 1: The CPU/Sound Board Dip Switch (Sw. 300) Setting; and, 2: The Country Setting Option. For each country listed, the Dip Switch Setting is shown (Column 1). At this time, not all countries have a *unique* Dip Switch Setting. For the countries without a unique setting, the USA Setting (or all positions in the "OFF" position) is used. In lieu of determining the best *Pricing Scheme* for your location, "pre-sets" were made available which would best suit any given situation. If the Factory Default setting is not the selection you feel is best for your location, choose any of the other pre-set settings. If any of these settings do not suit your needs, then **CUSTOM PRICING** will need to be accomplished (however, any "custom" changes made here will be lost after a **FACTORY RESET** so it is suggested to write down your unique set-up).

The Standard Pricing Select Table Explained:

Column 1: CPU/Sound Board Dip Switch 300 Settings: (self-explanatory). **Column 2:** Country Setting Option: The different available pre-sets are listed. **Columns 3-6:** Coin Mechanisms - These show the coinage through the available slots on the Coin Doors. Different countries use different Coin Doors. For example, USA style Coin Doors, which have only 2 coin acceptors (left & right) may utilize the "Center" slot cable for an optional Bill Validator. Different Coin Doors may have up to 4 coin acceptors. **Columns 7-10:** Pricing Scheme Explained - Shows the number of plays received for the monies required determined by the setting selected.

Standard Pricing Select Table

CPU/SOUND BOARD DIP SWITCH 300 SETTINGS	COUNTRY SETTING OPTION	Coin Mechanisms				Pricing Scheme Explained					
		COINS THRU ... SLOT:				Number of "Plays" for Price Amount Shown					
		LEFT	CENTER	RIGHT	4TH						
Pos: 1 2 3 4 5 6 7 8 ON: <input type="checkbox"/> <input type="checkbox"/> <input type="checkbox"/> <input type="checkbox"/> <input type="checkbox"/> <input type="checkbox"/> <input type="checkbox"/> <input type="checkbox"/> OFF: <input type="checkbox"/> <input type="checkbox"/> <input type="checkbox"/> <input type="checkbox"/> <input type="checkbox"/> <input type="checkbox"/> <input type="checkbox"/> <input type="checkbox"/>	USA 1	25¢	\$1.00	25¢		1 /25¢					
	USA 2					1 /50¢		2 /75¢		3 /\$1.00	
	USA 3					1 /50¢					
	USA 4					1 /50¢					
	USA 5 (Default)					1 /50¢		5 /\$2.00			
	USA 6					1 /50¢		2 /'4 X 25¢'		3 /\$1.00 Bill ← Used to promote the Bill Validator	
	USA 7					1 /50¢		4 /\$1.50		6 /\$2.00	
	USA 8					1 /50¢		3 /\$1.00			
Pos: 1 2 3 4 5 6 7 8 ON: <input type="checkbox"/> <input type="checkbox"/> <input type="checkbox"/> <input type="checkbox"/> <input type="checkbox"/> <input type="checkbox"/> <input type="checkbox"/> <input type="checkbox"/> OFF: <input type="checkbox"/> <input type="checkbox"/> <input type="checkbox"/> <input type="checkbox"/> <input type="checkbox"/> <input type="checkbox"/> <input type="checkbox"/> <input type="checkbox"/>	Euro 1 (Default)	20¢	50¢	€1.00	€2.00	1 /50¢					
	Euro 2					2 /50¢					
	Euro 3					1 /50¢		5 /€2.00			
	Euro 4					1 /50¢		3 /€1.00			
	Euro 5					1 /€1.00		2 /€1.50		3 /€2.00	
	Euro 6					1 /€1.00		5 /€2.00			



Standard Pricing Select Table - (Continued)

CPU DIP SWITCH SETTINGS Location SW300 CPU/SOUND BOARD		COUNTRY SETTING OPTION † ‡	Coin Mechanisms COINS THRU ... SLOT: LEFT CENTER RIGHT 4TH				Pricing Scheme Explained <i>Number of "Plays" for Price Amount Shown</i>					
Pos. 1 2 3 4 5 6 7 8			Please Note: for all USA Settings, see previous page (bottom).									
ON	▲	Austria †	5S	10S	10S			1 /10S	2 /15S	3 /20S		
OFF	▼											
Pos. 1 2 3 4 5 6 7 8		Australia 1 ‡	20¢	\$A 1	\$A 2			1 /\$A 1	3 /\$A 2			
ON	▲											
OFF	▼	Australia 2 ‡						1 /\$A 1				
Pos. 1 2 3 4 5 6 7 8		(Belgium †)	5 BF	20 BF	50 BF			1 /20 BF	3 /50 BF			
ON	▲											
OFF	▼											
Pos. 1 2 3 4 5 6 7 8		(Brazil †)	This country uses unique Tokens and/or Debit Cards only (pricing varies).						1 /'2 coins'			
ON	▲											
OFF	▼											
Pos. 1 2 3 4 5 6 7 8		Canada †	25¢	25¢	Can\$ 1			1 /50¢	2 /75¢	3 / Can\$ 1		
ON	▲											
OFF	▼											
Pos. 1 2 3 4 5 6 7 8		Denmark 1 ‡	1 DKr	5 DKr	10 DKr	20 DKr		1 /3 DKr	2 /5 DKr			
ON	▲											
OFF	▼	Denmark 2 ‡						1 /2 DKr	3 /5 DKr	7 /10DKr		
Pos. 1 2 3 4 5 6 7 8		Finland ‡	1 Fmk	5 Fmk				1 /5 Fmk	4 /10 Fmk			
ON	▲											
OFF	▼											
Pos. 1 2 3 4 5 6 7 8		France 1 †	1 Fr	5 Fr	10 Fr	20 Fr		1 /3 Fr	2 /5 Fr	5 /10 Fr	11 /20 Fr	
ON	▲											
OFF	▼	France 2						1 /5 Fr	3 /10 Fr	7 /20 Fr		
Pos. 1 2 3 4 5 6 7 8		France 3						1 /3 Fr	2 /5 Fr	4 /10 Fr	9 /20 Fr	
ON	▲											
OFF	▼											
Pos. 1 2 3 4 5 6 7 8		Germany 1	1 DM	2 DM	5 DM			1 /1 DM	6 /'1 X 5 DM'			
ON	▲											
OFF	▼	Germany 2						1 /2 DM	2 /3 DM	3 /4 DM	4 /5 DM	
Pos. 1 2 3 4 5 6 7 8		Germany 3 †						1 /2 DM	2 /3 DM	3 /4 DM	5 /5 DM	
ON	▲											
OFF	▼	Germany 4						1 /1 DM	6 /5 DM			
Pos. 1 2 3 4 5 6 7 8		Greece ‡	50 Dr		100 Dr			1 /50 Dr	3 /100 Dr			
ON	▲											
OFF	▼											
Pos. 1 2 3 4 5 6 7 8		Hong Kong ‡	1 HK\$	2 HK\$	5 HK\$			1 /5 HK\$				
ON	▲											
OFF	▼											
Pos. 1 2 3 4 5 6 7 8		Hungary ‡	10 Ft	10 Ft	20 Ft			1 /20 Ft	3 /40 Ft			
ON	▲											
OFF	▼											
Pos. 1 2 3 4 5 6 7 8		Italy 1 †	500 Lit		500 Lit			1 /500 Lit				
ON	▲											
OFF	▼	Italy 2						1 /1000 Lit	3 /2000 Lit			
Pos. 1 2 3 4 5 6 7 8		Japan 1 †			100¥			1 /100¥				
ON	▲											
OFF	▼	Japan 2						1 /100¥	3 /200¥			
Pos. 1 2 3 4 5 6 7 8		Korea ‡	100 Won		100 Won			1 /100 Won				
ON	▲											
OFF	▼											
Pos. 1 2 3 4 5 6 7 8		Netherlands 1	1 Fls.	1 Fls.	2.5 Fls.			1 /1 Fls.	3 /2.5 Fls.			
ON	▲											
OFF	▼	Netherlands 2 †		2.5 Fls.	5 Fls.			1 /1 Fls.	3 /2.5 Fls.	6 /5 Fls.		
Pos. 1 2 3 4 5 6 7 8		New Zealand 1 ‡	\$NZ 1		\$NZ 2			1 /\$NZ 1				
ON	▲											
OFF	▼	New Zealand 2 ‡						1 /\$NZ 1	3 /\$NZ 2			
Pos. 1 2 3 4 5 6 7 8		Norway 1 †	10 NKr	5 NKr	20 NKr			2 /10 NKr	1 /5 NKr	4 /20 NKr		
ON	▲											
OFF	▼	Norway 2						1 /10 NKr	3 /20 NKr			
Pos. 1 2 3 4 5 6 7 8		Spain ‡	100 Pts		500 Pts			1 /100 Pts	6 /500 Pts			
ON	▲											
OFF	▼											
Pos. 1 2 3 4 5 6 7 8		Sweden 1 †	1 SKr	5 SKr	10 SKr			1 /10 SKr	2 /15 SKr	3 /20 SKr		
ON	▲											
OFF	▼	Sweden 2						1 /5 SKr	2 /10 SKr			
Pos. 1 2 3 4 5 6 7 8		Switzerland 1 †	1 SwF	2 SwF	5 SwF			1 /1 SwF	6 /5 SwF			
ON	▲											
OFF	▼	Switzerland 2						1 /1 SwF	3 /2 SwF	9 /5 SwF		
Pos. 1 2 3 4 5 6 7 8		UK 1 †						3 /£1	7 /£2	The Pricing Scheme using the New UK Dip Sw. Setting (with 2, 3 & 4 = ON), is the same (UK1 - UK6). Use only with the New Style Coin Mech. The New 50p & £2 Coins can be accommodated in 5th & 6th Coin Slots.		
ON	▲	UK 2						4 /£1	8 /£2			
OFF	▼	UK 3	10p	50p	£1	20p		1 /50p	2 /£1	5 /£2		
Pos. 1 2 3 4 5 6 7 8		UK 4						1 /30p	2 /60p	3 /90p	4 /£1	
ON	▲											
OFF	▼	UK 5						1 /£1	3 /£2	This is "software controlled" by noting the presence/non-presence of pulses via Normal Coin Slots 1-4 (Left, Center, Right & 4th). If an old style Coin Mech is used, see new adjustment to accommodate.		
Pos. 1 2 3 4 5 6 7 8		UK 6						3 /£2				

Notes: † Indicates Factory Default for that setting.

‡ Indicates a USA Dip Switch Setting (all positions in the "OFF" position).

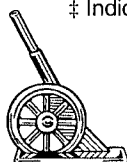

**Section 3, Chapter 4:
Go To Adjustments Menu**



S.P.I. Adjustments Continued.

Adjustment Name	Adjustment Definition
Adj. 8 RESET COIN AUDITS	Set to YES or NO . Default is NO . ▲ When set to YES (select the "+" Icon to change) all <i>Coin Audits</i> (Audits 5-11), will be reset to zero.
Adj. 9 RESET GAME AUDITS	Set to YES or NO . Default is NO . ▲ When set to YES (select the "+" Icon to change) all audits will be reset to zero, except for the <i>Coin Audits</i> (Audits 5-11) and Audit 12, Software Meter (the only audit which cannot be reset to zero).
Adj. 10 RESET HIGH SCORES	Set to YES or NO . Default is NO . When set to YES (select the "+" Icon to change) all the High Score Levels and associated initials will be restored to the backup settings.
Adj. 11 MATCH PERCENTAGE	Set between 0% - 10% or OFF . Default is 8% . At 0% the match display occurs at the end of the game but never awards a credit.
Adj. 12 BALLS PER GAME	Set between 02 - 05 . Default is 03 . Adjusts the number of balls per game.
Adj. 13 TILT WARNINGS	Set to 00 , 01 or 03 . Default is 01 . Adjusts the number of plumb bob tilt switch closures before the ball in play is tilted.
Adj. 14 REPLAY BOOST	Set to YES or NO . Default is YES . When set to YES , exceeding a replay will set a temporary replay level for each time a replay level is surpassed. This new level will equal the previous replay level (when the replay was awarded) plus 50M for each following game, until the replays have all been played (then the previous level is resumed).
Adj. 15 CREDIT LIMIT	Set between 04 - 50 . Default is 30 . Adjusts the maximum number of credits that may be posted.
Adj. 16 ALLOW HIGH SCORES	Set to YES or NO . Default is YES . When set to YES if a player exceeds any 1 of the 4 High Scores, the player may receive an award (depending on Adj. 3, Replay Award). Set to NO to disable this feature. There are 10 High Scores that will allow the player to enter their initials (or name) (See Adj. 32, High Score Initials), however, only the top 4 can receive an award if this adjustment is enabled.
Adj. 17 HIGH SCORE #1 AWARDS	Set between 00 - 05 . Default is 01 . Adjusts the number of awards awarded for exceeding Level 1 (<i>the highest of the four (4) Levels</i>).
Adj. 18 HIGH SCORE #2 AWARDS	Set between 00 - 03 . Default is 01 . Adjusts the number of awards awarded for exceeding Level 2.
Adj. 19 HIGH SCORE #3 AWARDS	Set between 00 - 02 . Default is 01 . Adjusts the number of awards awarded for exceeding Level 3.
Adj. 20 HIGH SCORE #4 AWARDS	Set between 00 - 01 . Default is 00 . Adjusts the number of awards awarded for exceeding Level 4.
Adj. 21 DEFAULT HIGH SCORE #1	Set between 1,000,000 - 9,999,000,000 or 00 (<i>increments of 1M</i>). Default is 30,000,000 . Adjusts the desired High Score Level to which Level 1 may be achieved (not affected by Adj. 31).
Adj. 22 DEFAULT HIGH SCORE #2	Set between 1,000,000 - 9,999,000,000 or 00 (<i>increments of 1M</i>). Default is 26,000,000 . Adjusts the desired High Score Level to which Level 2 may be achieved (not affected by Adj. 31).
Adj. 23 DEFAULT HIGH SCORE #3	Set between 1,000,000 - 9,999,000,000 or 00 (<i>increments of 1M</i>). Default is 22,000,000 . Adjusts the desired High Score Level to which Level 3 may be achieved (not affected by Adj. 31).
Adj. 24 DEFAULT HIGH SCORE #4	Set between 1,000,000 - 9,999,000,000 or 00 (<i>increments of 1M</i>). Default is 20,500,000 . Adjusts the desired High Score Level to which Level 4 may be achieved (not affected by Adj. 31).
Adj. 25 Adj. 30 DEFAULT HIGH SCORE #5- DEFAULT HIGH SCORE #10	Set between 1,000,000 - 9,999,000,000 or 00 (<i>increments of 1M</i>). Default is... (<i>see table on page 34</i>). Adjusts the desired High Score Level to which Level 5 may be achieved (not affected by Adj. 31).
Adj. 31 HSTD RESET COUNT	Set between 100 - 9,900 or OFF (<i>increments of 100</i>). Default is 2,000 . HSTD (High Score To Date). Adjusts the number of games between automatic resets of high score levels to backup settings and ball time averager adjustments. Set to OFF for "no reset or adjustment".
Adj. 32 HIGH SCORE INITIALS	Set to 3 INITIALS or 10 LETTER . Default is 3 INITIALS . When set to 3 INITIALS , player is allowed only 3 initials to input. When set to 10 LETTER NAME , player is allowed to enter 10 initials to input.

Sec. 3: ... Adj. Menu





S.P.I. Adjustments Continued.

Adjustment Name	Adjustment Definition
-----------------	-----------------------

Adj. 33	FREE PLAY	Set to YES or NO . Default is NO . When set to YES , no coins are required for <i>Game Play</i> .
Adj. 34	CUSTOM MESSAGE	Set to ON , CHANGE or OFF . Default is ON . When set to CHANGE (select the "+" Icon to change settings until "CHANGE" appears in the display, then select the ">>" Icon to access.) This adjustment can be accessed in two (2) ways by either selecting the "S.P.I." Icon and advancing to this Adjustment 34 , or can be directly accessed by selecting the "ABCD CUST MSG" Icon in the ADJUSTMENTS MENU . View the definition at the end of this chapter under the Custom Message entry for the operation explanation.
Adj. 35	FLASH LAMP POWER	Set to NORMAL , DIM or OFF . Default is NORMAL . When set to DIM the Flash Lamps impulse power is reduced by 25% and when set to OFF the Flash Lamps will not flash.
Adj. 36	COIL PULSE POWER	Set to NORMAL , HARD or SOFT . Default is NORMAL . When HARD the coil pulse power is increased by 12.5% of the normal pulse rate. When set to SOFT the coil pulse power is decreased by 12.5% of the normal pulse rate. These adjustments are provided to compensate for Low Line or High Line voltage conditions where the solenoids appear to kicking too weak or too hard. Adjust as required.
Adj. 37	KNOCKER VOLUME	Set to NORMAL , LOW or OFF . Default is LOW . When set to LOW , the volume is decreased 50%. When set to OFF , no sound is heard when the "knocker" is sounded.
Adj. 38	GAME RESTART	Set to YES or NO . Default is YES . When set to YES , a new game may be started during any ball after the first ball is completed (if credits are available). Pressing the Start Button during the first ball will add additional players. When set to NO , the game disables the Start Button after the first ball until the final ball is in play. Review Section 2, Chapter 1, Game Operations & Features for details.
Adj. 39	EXTRA BALL PERCENTAGE	Set between 0% - 50% . Default is 20% . This adjustment allows the operator to adjust how frequently the Extra Ball Feature is made available to the player.
Adj. 40	BILL VALIDATOR	Set to YES or NO . Default is NO . When set to YES , in <i>Game Attract Mode</i> the Display will show an "Insert Bill Animation." When set to NO , the Display will show an "Insert Coin Animation."
Adj. 41	TOURNAMENT MODE	Set to NONE , IFPA , EXPO , PAPA or HOME . Default is NONE . Tournament Mode determines the default conditions to quickly prepare a game for tournament play. When this setting is changed all audits will be reset and all adjustments will be initiated to the particular style selected. The game will then return to <i>Game Over Attract Mode</i> , as if a <i>Factory Reset</i> had been performed. NONE - Same as a Factory Reset conditions. IFPA - Straight 50¢ play, No Replay, No Extra Ball, No High Scores, 2 Tilt Warnings and No Match. EXPO or PAPA - Same as IFPA settings except Free Play is enabled. HOME - Sets game for Free Play , Extra Ball Play , No Replay , 10% Match & 30% Extra Ball .
Adj. 42	UK COIN MECH. TYPE	////// UK Only Dip Switch Set @ Option 2 //// Set to CURRENT: 2 POUND AT #5 if using a Coin Control Mech 74-1129-104U (latest version). Set to OLD: 2 POUND AT #6 if using older version Coin Control Mech 74-1129-104. Default is CURRENT: 2 POUND AT #5 .
Adj. 43	BKGRND (BACKGROUND) MUSIC VOLUME	Set between 01 - 15 . Default is 01 . After volume is set via Portals Service Buttons (See Sec. 3, Chp. 1, ...Intro) this adjustment can be utilized to adjust the background music (1 all the way on, 15 all the way off) while keeping the Special Sound FX the same level.
Adj. 44	LOCATION ID	Set between 00 to 9999 . Default is 00 . This adjustment allows the operator to assign a location identification number to the audit print-out sheet. (Will not be affected by <i>Factory Reset</i> .)
Adj. 45	GAME ID	Set between 00 to 9999 . Default is 00 . This adjustment allows the operator to assign a game identification number to the audit print-out sheet. (Will not be affected by <i>Factory Reset</i> .)

Sec. 3: ... Adj. Menu





MONOPOLY® Adjustments (46-63)

From the **ADJUSTMENTS MENU**, select the "MON" *Icon* with either **Red "LEFT"** or **Green "RIGHT" Button** and press the **Black "ENTER" Button**. Select and activate the "RIGHT ARROW" *Icon* to view the 1st adjustment in this group. Continue to select either of the "ARROW" *Icons* to view each adjustment one at a time. Select either the "-" or "+" *Icons* to change the value, if desired. The display will describe the adjustment number, the adjustment name, and the adjustment total or value. The current adjustment will remain in the display until the next adjustment is chosen or when the sub-menu is exited.

Adj. Nº	Adjustment Name	Adjustment Definition
Adj. 46	EXTRA BALL MEMORY	Set to YES or NO . Default is NO . When set to YES , this feature bonus will be retained in memory from ball-to-ball for the same player. When set to NO , this feature will go out at the end of each ball.
Adj. 47	SPECIAL MEMORY	Set to YES or NO . Default is YES . When set to YES , this feature bonus will be retained in memory from ball-to-ball for the same player. When set to NO , this feature will go out at the end of each ball.
Adj. 48	UK POST SAVE ENABLED	//////////////// UK Only Dip Switch Set @ Option 2 ////////////////// Set to YES or NO . Default is NO , (UK Default is YES). When set to YES this feature is available when lit. Set to NO to disable this feature. (UK Games have Outlane & Center Post Save Devices which are accessed in a different way; Non-UK Games cannot adjust this setting.)
Adj. 49	FREEZE TIME (BALL SAVE)	Set to OFF , 0:01-0:15 or AUTO . Default is OFF . When set to OFF this feature is unavailable. Set between 0:01 through 0:15 (single increments) for the ball to be sent back into play if the time set is not met (per ball). Set to AUTO to automatically adjust the Freeze Timer based on the average ball time.
Adj. 50	BANK DIFFICULTY	Set to EXEASY , EASY , MODERATE , HARD or EXHARD . Default is MODERATE . Determines how this Feature is started and played.
Adj. 51	REMATCH DIFFICULTY	Set to EXEASY , EASY , MODERATE , HARD or EXHARD . Default is MODERATE . Determines how this Feature is started and played.
Adj. 52	BONUS X DIFFICULTY	Set to EXEASY , EASY , MODERATE , HARD or EXHARD . Default is MODERATE . Determines how this Feature is started and played.
Adj. 53	DISABLE BANK	Set to YES or NO . Default is NO .
Adj. 54	TIMED PLUNGER	Set to OFF or 0:15 - 1:00 . Default is OFF . When set to 0:15 to 1:00 , the plunger will "Autoplunge" the ball (at the time set) when the ball is at the beginning of play, awaiting the skill shot by the player.
Adj. 55	ELECTRIC CO DIFF	Set to EXEASY , EASY , MODERATE , HARD or EXHARD . Default is MODERATE . Determines how this Feature is started and played.
Adj. 56	B-A-N-K LETTERS	Set between 00 - 04 . Default is 01 . Determines how many letters are spotted at game start.
Adj. 57	CHASE BALL	Set to YES or NO . Default is YES . Determines if another ball is given in the game after a ball is trapped/missing & ball search did not find it.
Adj. 58	POPS HITS TO MOVE TOKEN	Set between 00 - 06 . Default is 05 . Determines how many pop switch closures are required for a move of 1 space on the game board.
Adj. 59	ADV BANK AT NEW BALL	Set to YES or NO . Default is YES .
Adj. 60	RIGHT STANDUP SPOTS	Set between 00 - 04 . Default is 03 . Determines how many lights (modes "completed") are lit at game start by the Right Standup Target.
Adj. 61	CHANCE VUK STRENGTH	Set to EXEASY , EASY , MODERATE , HARD or EXHARD . Default is MODERATE . Determines VUK strength.
Adj. 62	START AT 1500 PTS	Set to YES or NO . Default is YES .
Adj. 63	ELEC. EB AT %	Set between 20 - 80 . Default is 30 . Determines the percentage required to get to in <i>Electric Company Increase Power Mode</i> .





Custom Message

To go directly to **Adjustment 34, Custom Message**, from the **ADJUSTMENT MENU**, select the "CUST MSG" *Icon* either **Red "LEFT"** or **Green "RIGHT" Button** and press the **Black "ENTER" Button**. At the top left corner of the Display, the letter **A** is indicated (blinking) in the first available position (Thirty-Six (36) characters including spaces are available). Vary the letter(s) by operating the Left and Right Flipper Buttons (or **"RED"** or **"GREEN" Buttons**). With the desired letter indicated, depress the **Start Button** to lock in the letter and advance to the next character. Repeat this procedure until the desired message is completed in the display. Select the "<" or ">" characters to back-space (erase) and/or to move forward in an already typed message. After completion, press the **"BLACK" Button**, **"REQUEST INSTALLED"** is indicated and then exits this sub-menu.



Film Star Reset (For the Home Setting)

To reset the game with *Special Home Settings (not the normal Factory Setting)*, from the **ADJUSTMENT MENU**, select the "STAR" *Icon* either **Red "LEFT"** or **Green "RIGHT" Button** and press the **Black "ENTER" Button**. This *Special Setting* automatically changes **Adjustment 6, Game Difficulty**, to **EASY** and **Adjustment 33, Free Play**, to **YES**. This setting is determined to be ideal for the home environment.

Take Note:



To **Restore** or **Reset** any of the adjustments to the *Factory Settings (Default)*, review Sec. 3, Chp. 5, **Go To Reset Menu**. Follow the "RESET" *Icon* or "FACT" *Icon* and their explanations.



Go To Reset Menu

Overview

The **Portals™ Service Menu System** provides three (3) functions to reset adjustments and/or audits back to the *Factory Setting*. See Chapter 3, Go to Audits Menu, and Chapter 4, Go to Adjustments Menu, for the Game Audits & Adjustments Information. If a reset of **Coin** or **Game Audits** is performed, the display will indicate **REQUEST INSTALLED** and return to the **RESET MENU**. If a **Factory Reset** is performed, the display will indicate **REQUEST INSTALLED**, the **Service Session** is *exited* & returns to the **Attract Mode**. Please note that once reset, all customized settings are lost! Certain *Audits & Adjustments* cannot be reset (refer to the details below).



GO TO RESET MENU

With the game in the **Attract Mode**, open the **Coin Door** and press the **Black "BEGIN TEST" Button**. Select the "RESET" *Icon* in the **MAIN MENU** with either **Red "LEFT"** or **Green "RIGHT" Button** and press the **Black "ENTER" Button**. The **RESET MENU** appears.

Important Notes:



Exit any sub-menu and return to the **MAIN MENU** by selecting & activating the "PREV" *Icon*.



Selecting & activating the "QUIT" *Icon* from the display will exit the **Service Session**.



Selecting & activating the "HELP" *Icon* from the display will show a help screen. (An explanation of each *Mini-Icon* at that level will cycle continuously until any active button is pressed.)



Reset Coin Audits

From the **RESET MENU**, select the "COIN" *Icon* with either **Red** or **Green Button** and press the **Black Button**. ⚠ All Coin Audits (See **Fig. 1**) will be reset to **Factory Settings**. The display will indicate **REQUEST INSTALLED** and return to the **RESET MENU**. Coin Audits can also be reset from the **ADJUSTMENTS MENU, S.P.I. ADJUSTMENT 8**. See Chapter 4, Go to Adjustments Menu, of this section. After selecting this *Icon*, all of the **Coin Audits (5-11)** are reset to zero.



Reset Game Audits

From the **RESET MENU**, select the "AUD" *Icon* with either **Red** or **Green Button** and press the **Black Button**. ⚠ All Game Audits (See **Fig. 2**) will be reset to **Factory Settings**. The display will indicate **REQUEST INSTALLED** and return to the **RESET MENU**. Game Audits can also be reset from the **ADJUSTMENTS MENU, S.P.I. ADJUSTMENT 9**. See Chapter 4, Go to Adjustments Menu, of this section. After selecting this *Icon*, all of the **Audits** are reset to zero, except for the **Coin Audits (Audits 5-11)** and **Audit 12, Software Meter**. Audit 12 is the only audit which cannot be reset.

Fig. 1

• Reset Coin Audits	
Earnings Audits (Coin Audits Only 5-11)	
Au. Nº	Description
1-4	The first 4 Audits in the game.
5	Coins Thru Left Slot
6	Coins Thru Right Slot
7	Coins Thru Center Slot
8	Coins Thru 4th Slot
9	Total Coins
10	Total Earnings
11	Meter Clicks
12	Software Meter
13 +	The remainder of the Audits.

Fig. 2

• Reset Game Audits	
Earnings (1-4), Generic/Specific Audits (13+)	
Au. Nº	Description
1-4	The first 4 Audits in the game.
5	Coins Thru Left Slot
6	Coins Thru Right Slot
7	Coins Thru Center Slot
8	Coins Thru 4th Slot
9	Total Coins
10	Total Earnings
11	Meter Clicks
12	Software Meter
13 +	The remainder of the Audits.

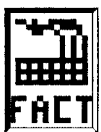

Factory Reset

From the **RESET MENU**, select the "FACT" *Icon* with either **Red** or **Green Button** and press the **Black Button**. ⚠ All adjustments will be reset to **Factory Settings** (except for **Proprietary Adjustments**). The display will indicate **REQUEST INSTALLED** and exit the **Service Session**. See Chapter 4, Go to Adjustments Menu, of this section, for the **Factory Settings** in the **Game Adjustment Table**.

Example:

From the **MAIN MENU**, use the **Red** or **Green Buttons** to select the "RESET" *Icon* (GO TO RESET MENU).

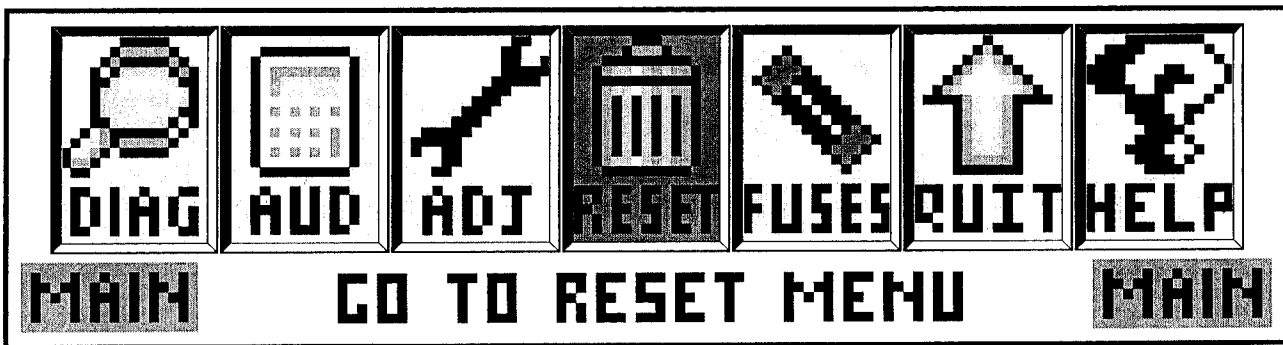

Press the **Black Button** to activate this **ICON**. This will bring up the **RESET MENU**.

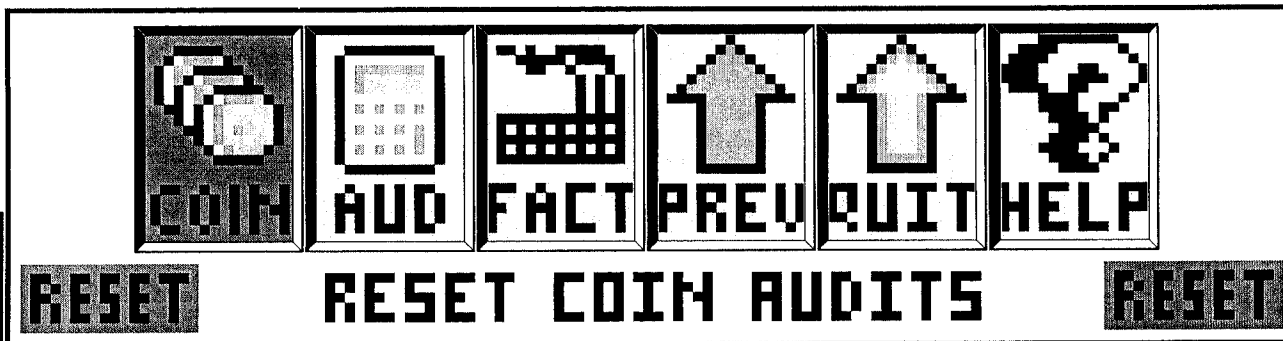

Sec. 3: ...Reset Menu

The **RESET MENU** now appears with the "COIN" *Icon* (RESET COIN AUDITS) flashing:



DO NOT PRESS THE START BUTTON AFTER SELECTING ANY THREE OF THESE ICONS UNLESS THIS IS WHAT IS DESIRED (SETTINGS WILL BE LOST)! PLEASE READ THE PREVIOUS PAGE FOR EXACTLY WHAT WILL HAPPEN IF ANY OF THESE THREE ICONS ARE ACTIVATED.



From the **RESET MENU**, select any of the *Icons* ("COIN", "AUD" or "FACT") with either **Red** or **Green Button** and press the **Black Button** to activate the **ICON** chosen.



If the "COIN" or "AUD" *Icons* are chosen and activated, the affected audits (see previous page) will be reset, the display will indicate **REQUEST INSTALLED** and the display will return to the **RESET MENU**.

If the "FACT" *Icon* is chosen and activated, all adjustments will be reset back to the *Factory Settings*. The display will indicate **REQUEST INSTALLED** (momentarily), the **Service Session** is automatically *exited* and returns to the **Attract Mode**.

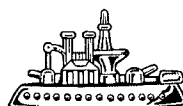

Go To Fuse Table

Overview

The **Portals™ Service Menu System** provides a current Fuse Table for this game. The fuses are located in the Backbox (on the Display Power Supply Board and the I/O Power Driver Board), and also in the Cabinet (under the playfield by the Flippers and/or by any unique assembly, such as magnets). For the complete Fuse List in the *Quick Reference Fuse Chart & Pictorials*, see the next page (identical to page DR. 1 in the front of this manual).



GO TO FUSE TABLE

With the game in the Attract Mode, open the Coin Door and press the **Black "BEGIN TEST" Button**. Select the "FUSES" *Icon* in the **MAIN MENU** with either **Red "LEFT" or Green "RIGHT" Button** and press the **Black "ENTER" Button**. Select and activate the "+" *Icon* to view the 1st fuse in this group. Continue to select either the "+" or "-" *Icons* to view each fuse one at a time. The display will describe the fuse identification number (e.g. F1, F6, F7, etc.), location of fuse (i.e. Backbox: Board name located on; or Cabinet: Under the playfield or in Service Outlet), rating of fuse (e.g. 5A 250v S.B. - i.e. 5 Amp, 250 volt, Slo-Blo), and 'use of fuse' (e.g. 90v DC High Voltage Power, etc.). The current fuse listed will remain in the display until the next fuse is chosen or when the sub-menu is exited.

Important Notes:



Exit any sub-menu and return to the **MAIN MENU** by selecting & activating the "PREV" *Icons*. If no *Icons* appear in the display because of a testing function or special display (e.g. "Help"), press any button to exit.



Selecting & activating the "QUIT" *Icon* from any display will exit the Service Session.



Selecting & activating the "HELP" *Icon* from any display will show a help screen. (An explanation of each *Mini-Icon* at that level will cycle continuously until any active button is pressed.)



Selecting & activating the "+" or "-" *Icons* selects the next or previous fuse in this group.

Example:

From the **MAIN MENU**, use the **Red or Green Buttons** to select the "FUSES" *Icon* (GO TO FUSE TABLE).

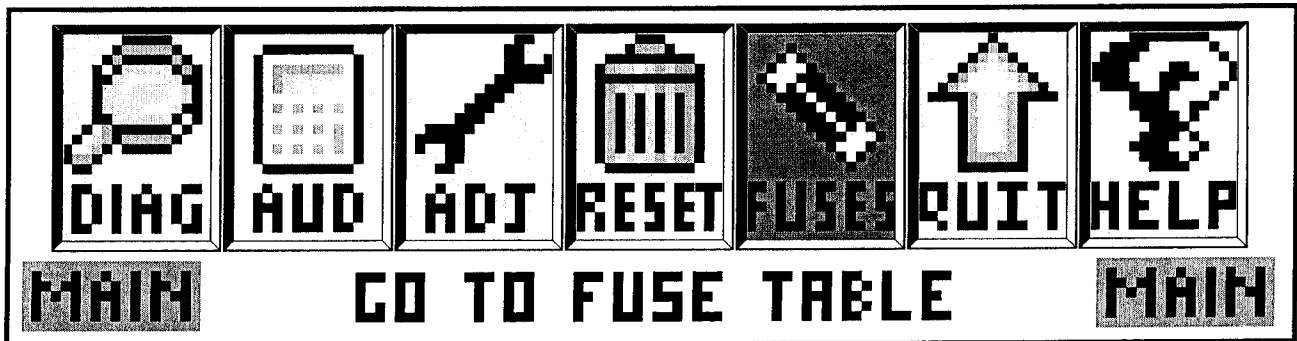

Press the **Black Button** to activate this **ICON**. This will bring up the **MONOPOLY FUSE TABLE**.

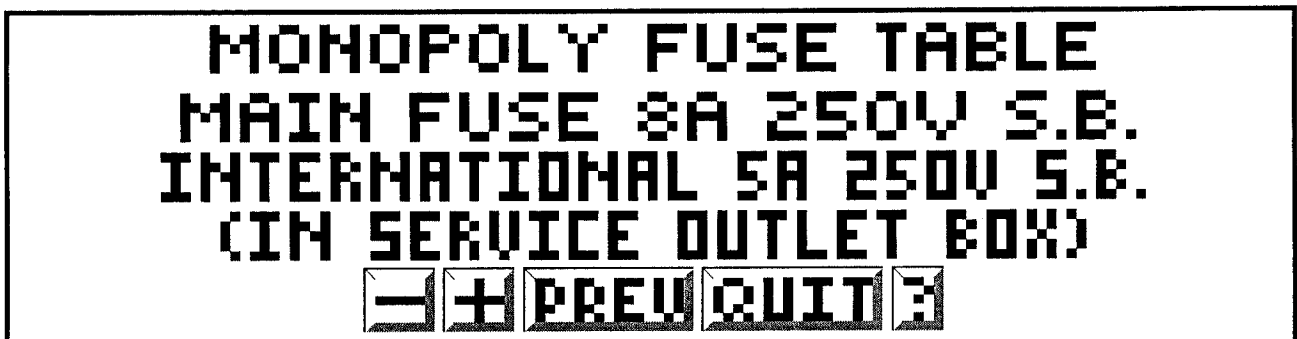

Sec. 3: ... Fuse Table



▼ BACKBOX LAYOUT LOCATIONS: Fuses, Bridges, Relays & ROMs ▼

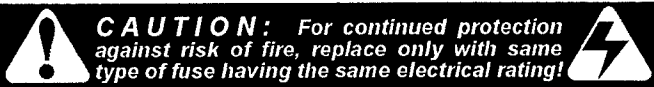

QUICK REFERENCE FUSE CHART

Backbox Fuses

LOC: DISPLAY POWER SUPPLY (P.S.) BOARD

F1 3/4A 250v S.B. 90v DC High Voltage Display

LOC: I / O POWER DRIVER BOARD

F6 7A 250v S.B. 50v DC Primary High Power Coils/Flippers

F7 5A 250v S.B. 20v DC Low Power Coils

F8 5A 250v S.B. 12v DC Logic Power

F9 5A 250v S.B. 12v DC Logic Power

F20 3A 250v S.B. 50v DC Magnet

F21 3A 250v S.B. 50v DC Coils

F22 8A 250v S.B. 18v DC Controlled Lamps

F23 4A 250v S.B. 5v DC Logic

F24 5A 250v S.B. 6.3v AC G.I. Lamps (BRN-WHT to WHT-BRN)

F25 5A 250v S.B. 6.3v AC G.I. Lamps (YEL to WHT-YEL)

F26 5A 250v S.B. 6.3v AC G.I. Lamps (GRN to WHT-GRN)

F27 5A 250v S.B. 6.3v AC G.I. Lamps (VIO to WHT-VIO)

F28 3A 250v S.B. 24v AC Not Used / Spare

Cabinet Fuses

LOC: SERVICE (AC) OUTLET BOX (Cabinet Bottom)

n/a 8A 250v S.B. 115v AC Main Fuse Line (Domestic or USA)

n/a 5A 250v S.B. 220v AC Main Fuse Line (International)

Playfield Fuses

LOC: UNDER PLAYFIELD (near Flippers)

n/a 3A 250v S.B. 50v DC Rt. Flipper (BLU-YEL↔RED-YEL)

n/a 3A 250v S.B. 50v DC Lt. Flipper (GRY-YEL↔RED-YEL)

n/a 3A 250v S.B. 50v DC Up. Flipper (GRY-YEL↔RED-YEL)

For other fuses, if any, locations & more information, see Page 95.

For Backbox & Cabinet General Parts, review Section 4, Chapter 1, Parts Identification & Location (The Pink Pages).

For Schematics and/or Component Parts on above Boards, review Section 5, Chapter 4, Printed Circuit Boards (The Yellow Pages).

Display Power Supply Board

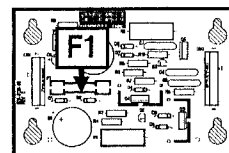

CPU / Sound Board

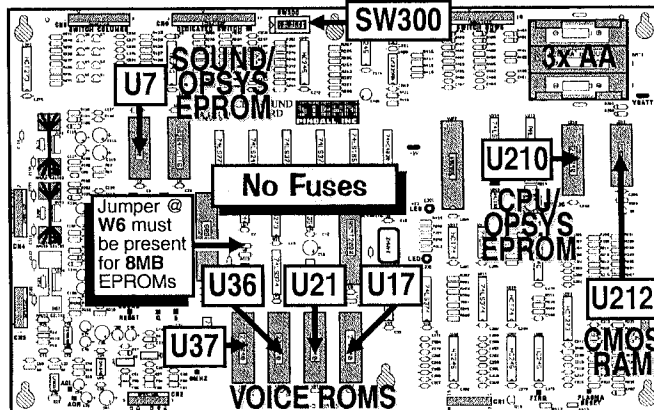

I/O Power Driver Board

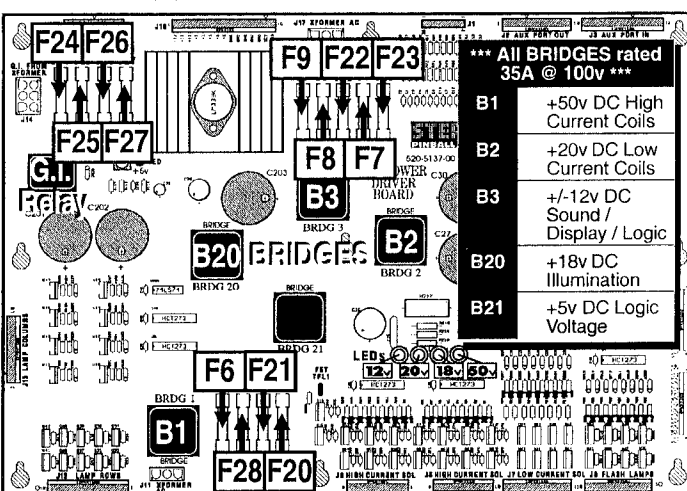

- *** All BRIDGES rated 35A @ 100v ***
- B1 +50v DC High Current Coils
 - B2 +20v DC Low Current Coils
 - B3 +/-12v DC Sound / Display / Logic
 - B20 +18v DC Illumination
 - B21 +5v DC Logic Voltage

Sec. 3: ... Fuse Table

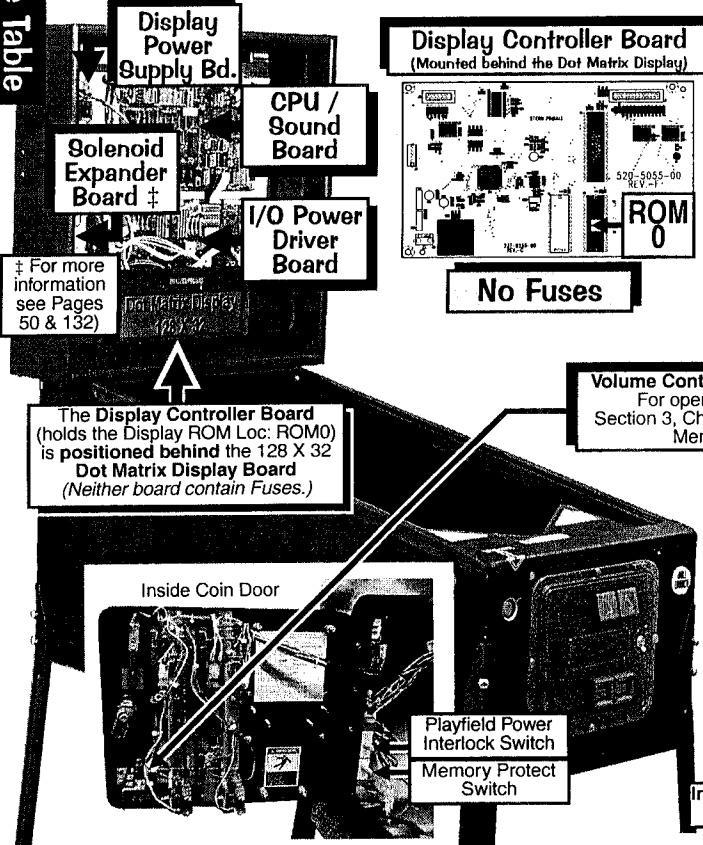

The Display Controller Board (holds the Display ROM Loc: ROM0) is positioned behind the 128 X 32 Dot Matrix Display Board (Neither board contain Fuses.)

Volume Control & Service Switches
For operational usage, see Section 3, Chapter 1, Portals Service Menu Introduction

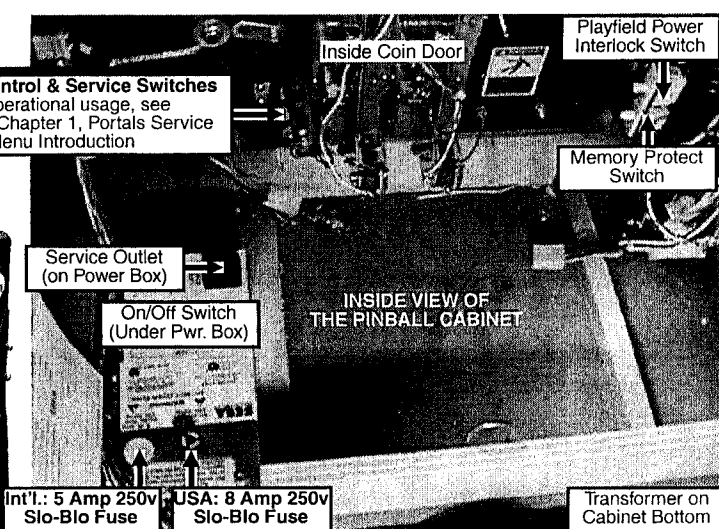

Int'l.: 5 Amp 250v Slo-Blo Fuse USA: 8 Amp 250v Slo-Blo Fuse Transformer on Cabinet Bottom

Go To Help Screen

Overview

The **Portals™ Service Menu System** provides help screens in each display (except if the display is in a testing mode). Help Screens provide different information depending on where the "HELP" or "?" *Icons* are selected. Read all chapters in this section for a complete understanding of this pinball game. For more help, utilize the "Dr." *Icon* in the **DIAGNOSTICS MENU** (see the end of Chapter 2 in this section). The table on the next page was designed to provide solutions to some common problems frequently asked.



GO TO HELP SCREEN

With the game in the Attract Mode, open the Coin Door and press the **Black "BEGIN TEST" Button**. Select the "HELP" *Icon* in the **MAIN MENU** with either **Red "LEFT" or Green "RIGHT" Button** and press the **Black "ENTER" Button**. The below screens appear and will continuously cycle until any **Button** is pressed bringing back the **MAIN MENU**.

Important Notes:



Exit any sub-menu and return to the **MAIN MENU** by selecting & activating the "PREV" *Icons*. If no *Icons* appear in the display because of a testing function or special display (e.g. "Help"), press any button to exit.



Selecting & activating the "QUIT" *Icon* from any display will exit the Service Session.



Selecting & activating the "HELP" *Icon* from any display will show a help screen. (An explanation of each *Mini-Icon* at that level will cycle continuously until any active button is pressed.)



These "Mini-Icons" vary in functionality depending in what sub-menu they are used. Refer to the beginning of each chapter in this section for the function they serve in that menu or select the "HELP" *Icons* in the display where the *Icon* in question is being used.

Help Screens from the MAIN MENU:

**USE FLIPPER BUTTONS
(OR RED AND GREEN COIN
DOOR BUTTONS) TO CHANGE
THE SELECTED ICON.**

**PRESS START BUTTON
(OR ENTER) TO
ACTIVATE THE
SELECTED ICON.**

Sec. 3: ...Help Screen

This concludes the **Portals™ Service Menu**. Review the Table of Contents at the beginning of this manual, and the detailed Table of Contents for Section 3 to quickly find the information required. The remainder of the sections in this manual cover all the parts in this game and provide helpful information to aide in troubleshooting. If questions still arise after reading this section completely, call TECH SUPPORT or visit our website at www.sternpinball.com.





PORTALS™ SERVICE MENU PROBLEM/SOLUTION TABLE



Use this table for a quick simple solution(s) guide. For more technical assistance view Section 5.

PROBLEM	SOLUTION
Will not enter the Service Mode after depressing the Black "BEGIN TEST" Button .	<ul style="list-style-type: none"> • Check the Service Switch(es) (Red, Green & Black Buttons) for loose connections or bad Ground. • Check the associated wiring harness to/from the CPU Board Connector CN6. • Check CPU Board, possibly failed.
All Service Buttons (Red, Green and Black) appear nonfunctional.	<ul style="list-style-type: none"> • Check the Service Switches for poor connections or broken wires.
The Green Service Button in the Attract Mode will not enter the Service Credits Menu to add Service Credits.	<ul style="list-style-type: none"> • Check to make sure the Game is not in "Free Play." <i>If the game is set to Free Play, adding Service Credits is not required.</i> • Check the Service Switch(es) for poor connections or broken wires.
The display blanks out.	<ul style="list-style-type: none"> • Check the Dot Matrix Display for loose wiring harness connections. • Check F1 (3/4A Fuse) on the Display Pwr. Supply Bd. Refer to Section 5, Chapter 4, Schematics & Troubleshooting.
Icons "scroll" along continuously in the MAIN MENU .	<ul style="list-style-type: none"> • If the Service Switch Set and/or the Coin Door was replaced, ensure the Locking Mechanism on the Green Button is removed. If the Green Button "clicks" and locks into an up/down position, the Green Button has this lock switch. Remove it. (Ref. to Svc. Bulletin #74.)
The Start and Flipper Buttons do not select or activate <i>Icons</i> in the SWITCH TEST MENU .	<ul style="list-style-type: none"> • This is normal. These switches are deactivated, as they are a part of the Switch Test. Use the Red "LEFT" or Green "RIGHT" & Black "ENTER" Buttons in this Sub-Menu (see Chapter 1).
Can't move selection of <i>Icon</i> with the Left and/or Right Flipper Buttons .	<ul style="list-style-type: none"> • Check the Flipper Buttons for loose connections or bad Ground and refer to Section 5, Chapter 2, Playfield Wiring, #-Flipper Circuit Wiring Diagram. • This is normal only in Diagnostic's Switch & Active Switch Tests (see previous Problem).
Some <i>Icons</i> appear non-functional in the PRINTER MENU(S) .	<ul style="list-style-type: none"> • If no printing equipment is connected, the "-" <i>Icon</i>, "+" <i>Icon</i> and "RUN" <i>Icon</i> will appear not to function (see the end of Chapter 3).
Some <i>Icons</i> appear non-functional in the GAME SPECIFIC MENU under the DIAGNOSTICS MENU .	<ul style="list-style-type: none"> • If there is no other test under this Menu, the "Left Arrow" & "Right Arrow" <i>Icons</i> will appear not to function. The remaining <i>Icons</i> should function as normal. <i>Note: If there is no Game Specific Special Test, the "GAME SPECIFIC" Icon will not invoke another display.</i>
The display returns to the ATTRACT MODE exiting the Service Session from the FACTORY RESET MENU .	<ul style="list-style-type: none"> • This is normal. After a FACTORY RESET, the Service Session is automatically exited (see Chapter 4 (end) or Chapter 6).
In COIL TEST MENU , the coils and flashlamps do not fire after activating the "RUN" <i>Icon</i> .	<ul style="list-style-type: none"> • Ensure the POWER INTERLOCK SWITCH is pulled out (see Chapter 1).
In ADJUSTMENTS MENU , with the Coin Door CLOSED , adjustments are not getting changed as desired while using the Flipper & Start Buttons to select <i>Icons</i> and change values.	<ul style="list-style-type: none"> • This is normal. The Memory Protect Switch is enabled when the Coin Door is CLOSED. Changes can be made with the Coin Door OPEN only.
In Portals™ Service Menu , the volume cannot be adjusted with the Red or Green Buttons .	<ul style="list-style-type: none"> • The Volume adjustment can only be made when in the Attract Mode. The Volume Mode is entered by pressing the Red "VOLUME" Button. Then use the Red or Green Button to increase/decrease volume. (Red "LEFT" decrements; Green "RIGHT" increments.)
In Portals™ Service Menu , the display seems to lock up, or the Help Display appears to be non-functional.	<ul style="list-style-type: none"> • If you cannot clear the situation by exiting back one Menu, exit completely out of the Portals™ Service Menu, and re-enter. If the problem persists, call Technical Support for additional help.

Sec. 3: ...Help Screen



Parts Identification & Location (The Pink Pages)

Overview

This section provides the Part N^os and locations of all the components in this pinball machine. The parts are arranged in three groups: **BACKBOX, CABINET & PLAYFIELD**. Generic parts which may change as production continues (quantity and/or size) are listed together. Quantities greater than 0 indicates that the part is used in this game. Since quantity changes *may occur*, an item indicating "0" may be used. Compare the item which needs to be replaced with the drawings provided (the *Posts, Sockets, Bulbs & Rubber Rings* are drawn actual size). Major Assemblies & Ramps are detailed in the Blue Pages, Chapter 2. **Important:** Read all "Take Note:" items.

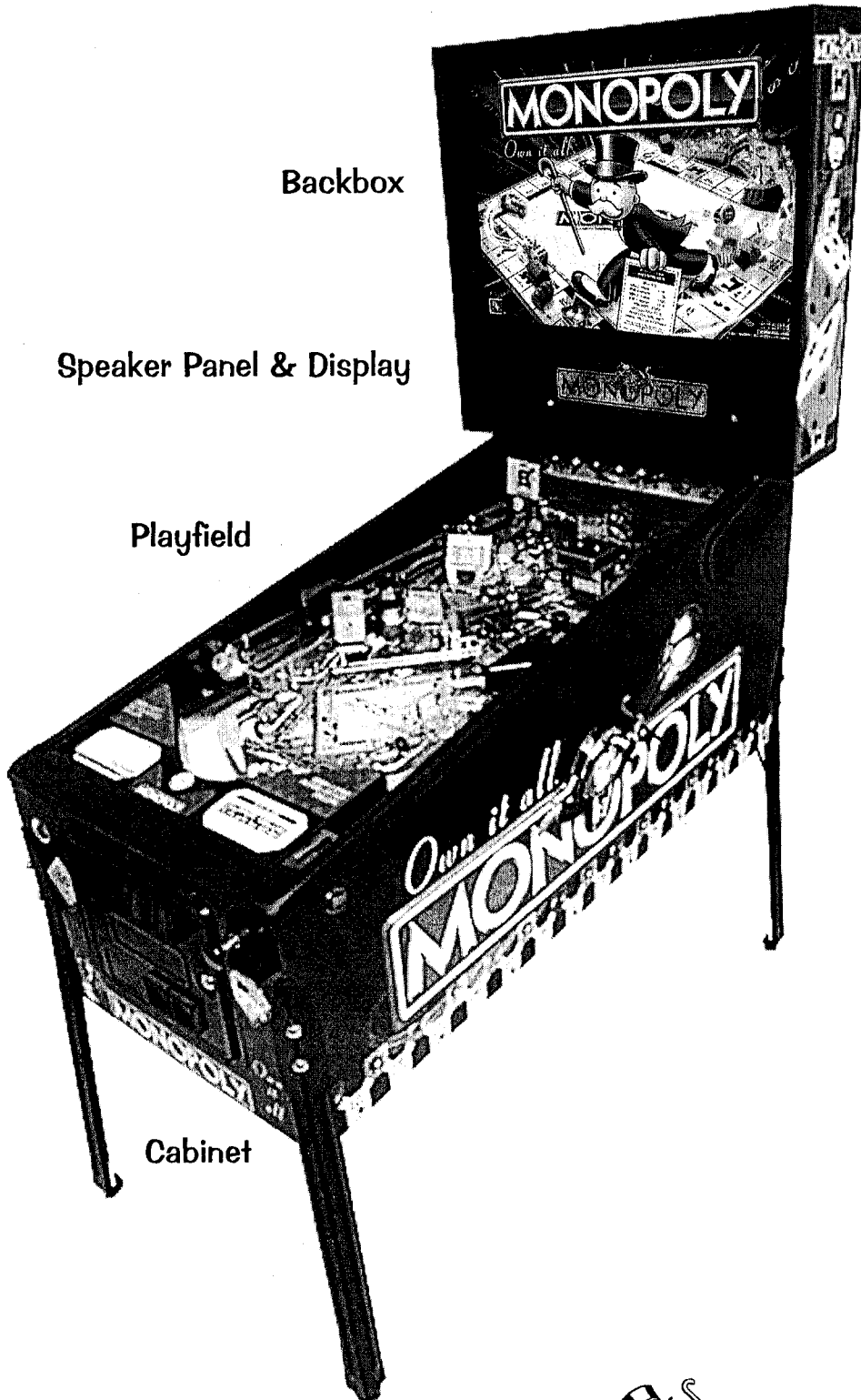

Backbox

Speaker Panel & Display

Playfield

Cabinet

Section 4, Table of Contents

Chapter 1 (The Pink Pages)

Overview49

BACKBOX:

MONOPOLY® Backbox Assy.50

Speaker Panel Assy. for the Backbox and Assoc. Parts:... 51

CABINET:

General Parts & Switches 52-53

PLAYFIELD:

General Parts & Switches (Below).....54

General Parts & Switches (Above)55

Rubber Parts56

Plastics (Screened & Clear) & Decals 57

Rails, Wire Forms, Ball Guides and Flat Metal Ramps 58

Metal Posts (Screws) and Nuts 59

Metal Spacers 60

Plastic Posts and Spacers 61

Small Bayonet Type Bulbs and Sockets62

Large Bayonet Type Bulb and Sockets 63

Wedge Base Bulbs and Sockets.....64

Sec. .4: Parts Id. ...

Chapter 2 (The Blue Pages)

Overview65

Drawings for Major Assemblies & Ramps 66-88



MONOPOLY Backbox Assembly, 505-6002-75-75 (Items 1-26)

Not sold as an assembly, order the individual part(s) actually required.

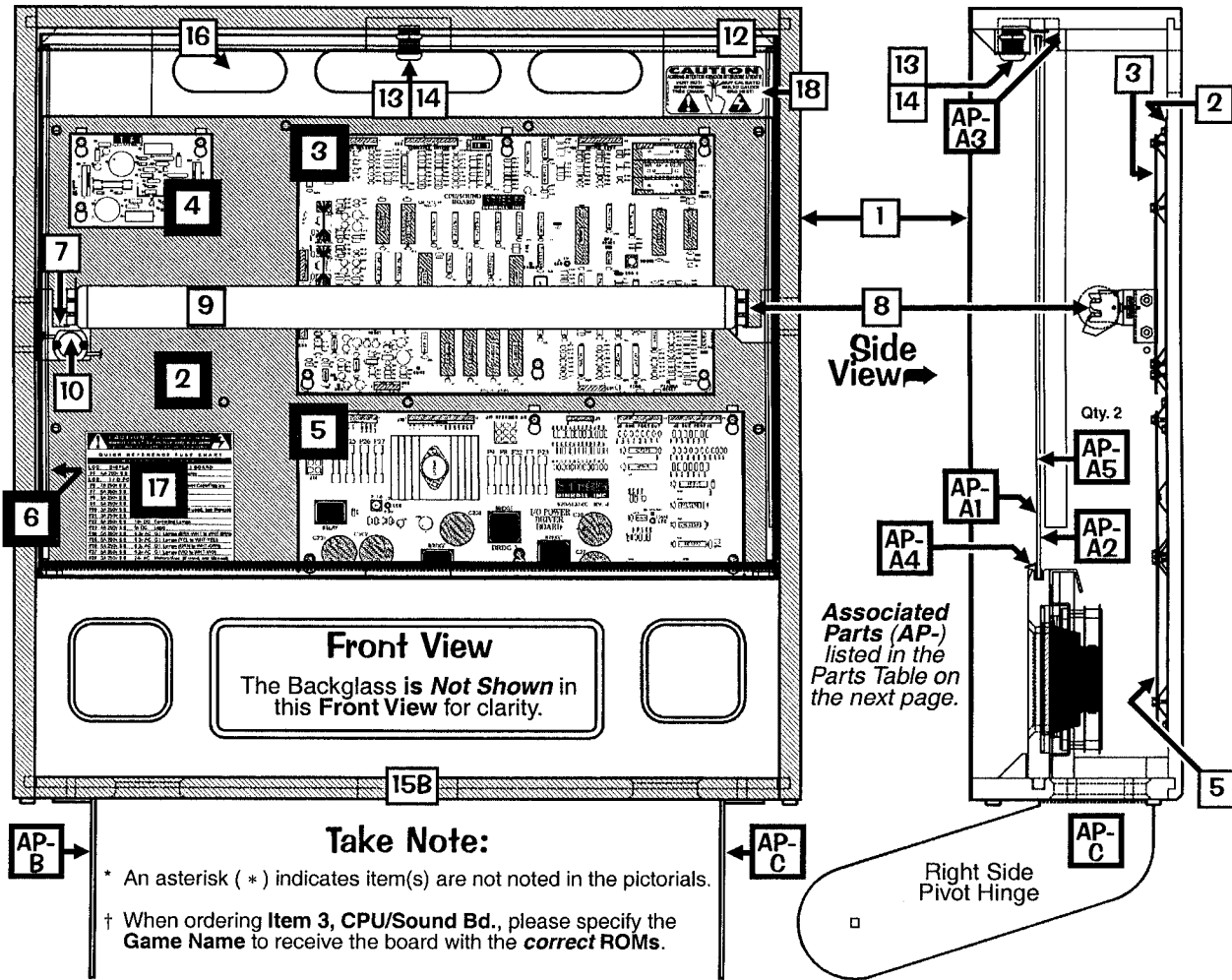

Sec. 4: Parts Id. ...

Nº	BACKBOX PART NAME	QTY.	SPI PART Nº	Nº	BACKBOX PART NAME	QTY.	SPI PART Nº
1	Backbox (MONOPOLY®)	1	525-5558-75	10*	Ground Strap (5") (by Item 12)	1	600-5006-05
<i>Item 1 Note: Black Textured T-Molding is installed and cannot be ordered separately.</i>							
2	PCB Metal Mounting Plate	1	535-5809-04	11	Starter - Fluorescent (FS2 Light)	1	165-5011-01
<i>Item 2 is secured to Item 1 by: #8 X 1/2" SHWH AB (Zinc) (Qty. 13) (234-5101-00) and #10 Washer 7/32" I.D. X .5" O.D. X 1/16" Thick (Qty. 4) (242-5003-00)</i>							
3 †	CPU/Sound Board (Mono) FCC-FEB98	1	520-5136-16	12	Ballast SP2/K 5/8" Core 120v 50/60 Hz 13W	1	010-5015-00
4	Display Power Supply Board	1	520-5138-00	<i>Ballast Mounting Plate</i>			
5	I/O Power Driver Board	1	520-5137-01	13	Lock Mounting Plate (2001)	1	535-8657-00
<i>Items 3, 4 & 5 are secured to Item 2 by: #8-32 X 3/8" HWH MS (Qty. 19) (237-5903-00)</i>							
6	Solenoid Expander Board (UK Only)	0	520-5192-00	14	Camlock (Cam 440X) & Key	1	355-5018-02
<i>Item 6 is required for UK Games Only to support the Left & Right Outline Ball Deflectors & Center Up/Down Post Assemblies not supported in the Normal Coil Matrix of Q1-Q32.</i>							
7	Fluorescent Light Bracket Assy. Left	1	515-6545-00	<i>Items 13-14 are secured by: #8 X 5/8" TP Torx T20 (Qty. 4) (237-5947-00)</i>			
ORDERING ABOVE (ITEM 7) SUB-ASSY. PART Nº WILL INCLUDE:							
7A	Fluorescent Light Bracket Left	1	535-7739-00	15A	#1 Roto Lock Male (on Cabinet)	1	355-5006-01
7B	Lamp Holder (Self-Locking)	1	077-5214-00	15B	#1 Roto Lock Female (R2-0002-02)	1	355-5006-02
7C	#6-32 X 5/8" PPH MS (Sems) Zinc	1	232-5203-00	<i>Item 15B is secured by: #10-24 X 1-3/4" CBSN (Qty. 2) (231-5022-00), #10-24 Keps Nut (Qty. 2) (240-5207-00) and #10 Washer 7/32" ID X .5" OD X 1/16" (Qty. 2) (242-5003-00)</i>			
7D	Starter Base (with Leads)	1	077-5213-00	16	Back Vent Grill 2-1/2" X 18"	1	545-5072-02
7E	#4-40 X 1/2" PPH MS (Sems) Zinc	2	237-5813-00	<i>Item 16 is secured by: Staple 5/16" (Qty. 24) (631-5000-00)</i>			
<i>Ordering Note: If 500-6545-00 is unavailable, order the individual part(s) actually required.</i>							
8	Fluorescent Light Bracket Assy. Right	1	515-6545-01	17	Fuse Description Decal (Generic)	1	820-6152-00
ORDERING ABOVE (ITEM 8) SUB-ASSY. PART Nº WILL INCLUDE:							
8A	Fluorescent Light Bracket Right	1	535-7739-01	18	"CAUTION - VERY HOT" Decal	1	820-6152-75
8B-8C	Identical to Items 7B-7C above.	See 6B-6C		19*	Fuse Label (UL)	1	820-6143-00
<i>Items 7 & 8 are secured by: #10-24 X 1-1/4" Carriage Bolt Sq. Neck (Qty. 2/par) (231-5012-00), #10-24 Keps Nut (Qty. 2/par) (240-5207-00) and 3/4" X 3" Reinforced Strapping Tape (Qty. 1, Sold in 12" Lengths only) (626-5040-00)</i>							
<i>Ordering Note: If 500-6545-01 is unavailable, order the individual part(s) actually required.</i>							
9	Fluorescent Tube (F20T12CW)	1	165-5031-02	20*	Backbox Date Label	1	820-5091-00
<i>Items 23-26 are secured to Item 1 by: #8 X 1/2" SHWH AB (Zinc) (Qty. 13) (234-5101-00)</i>							



MONOPOLY Speaker Panel Assy. for the Backbox, 515-6888-03 (Items 1-15) and Assoc. Parts: Backglass Assembly & Pivot Hinges (Left & Right) (Items AP-A - AP-C) Not sold as an assembly, order the individual part(s) actually required.

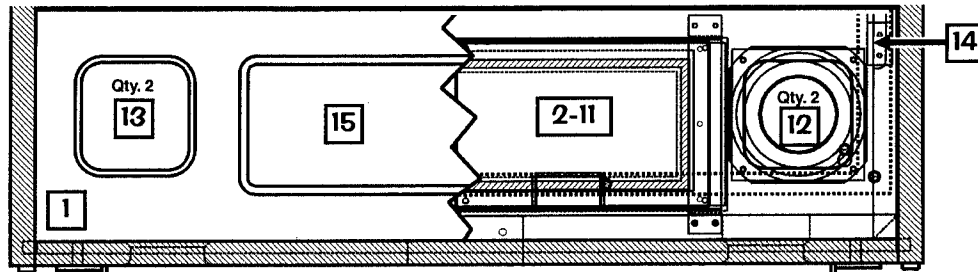

Take Note:

* An asterisk (*) indicates item(s) are not noted in the pictorials.

1. Ordering the complete Speaker Panel Assembly, 515-6888-03 (Items 1-15) will include all hardware.

Front View
(Broken View)

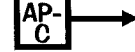
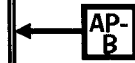

Side View (Laid Down)

For clarity, the below drawing *does not show* the speaker(s).

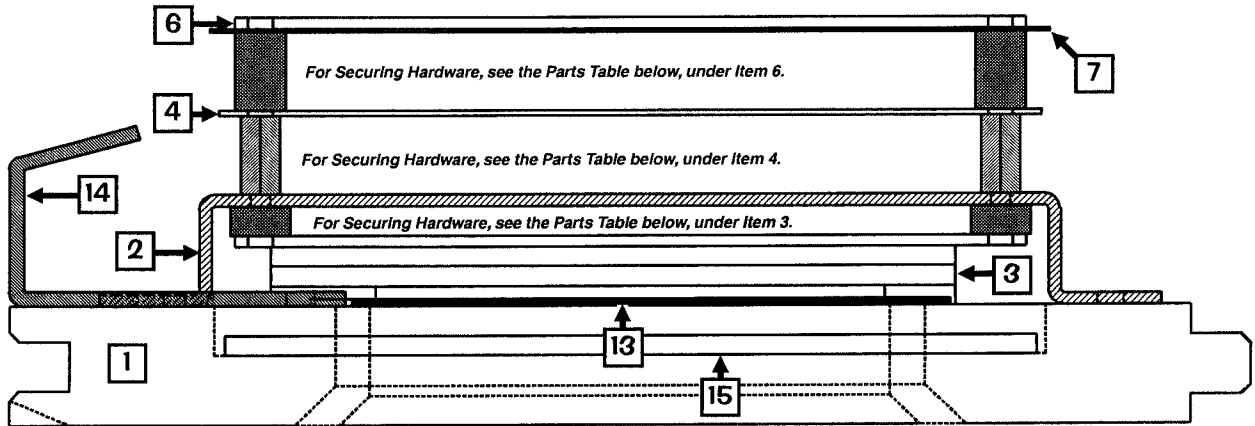

Nº	SPEAKER PANEL PART NAME	QTY.	SPI PART Nº	Nº	INDIVIDUAL PART NAME	QTY.	SPI PART Nº												
1	Speaker Panel (Black Wood)	1	525-5515-00	15	Plastic Shield (Display Cover)	1	545-5884-00												
2	Dot Matrix Disp. Bd. Mounting Bracket	2	535-8368-01	Item 15 is secured to Item 2 by: #6 X 3/8" HWH AB (Zinc) (Qty. 8) (234-5000-00)															
Item 2 is secured to Item 1 by: #8 X 3/4" HWH AB (Zinc) (Qty. 4/per) (234-5103-00)																			
3	Dot Matrix Display Board 128 X 32	1	520-5052-00	The Associated Parts AP-A thru AP-C are also noted in the Backbox Assembly drawings on the previous page.															
Item 3 is secured to Item 2 by (at corners): 3/16" X 3/8" Spacer Gray (Qty. 4) (254-5000-18) and #6-32 X 1/2" HWH Swage (Serr) Zinc (Qty. 4) (237-5976-03)																			
Item 3 is secured to Item 4 (at the top center) by: 3/4" X 1/4" Hex Spacer #6-32 Tap (Qty. 1) (254-5008-04) and #6-32 X 1/4" PPH MS (Sems) Zinc (Qty. 1) (232-5200-00)																			
4	Static Shield (Steel Plate)	1	535-6437-00	ASSOC. PARTS ARE NOT INCLUDED WITH BACKBOX/SPKR. PANEL ASSY'S.															
Item 4 is secured to Item 2 by: 1/2" X 1/4" Hex Spacer #6-32 Tap (Qty. 4) (254-5008-03) and #6-32 X 1/2" PPH MS (Sems) Zinc (Qty. 2, on Left Side only) (232-5202-00)																			
5*	Edge Protector (on Item 4)	2	545-5592-01	Nº	ASSOC. BACKBOX PART NAME	QTY.	SPI PART Nº												
6	Display Controller Board FCC-FEB98	1	520-5055-03	AP-A	Backglass Assembly (Game Nº 75)	1	See Parts Below												
Item 6 is secured to Item 4 by: 1/2" X 5/16" X .144 ID Spacer Tap (Qty. 3) (254-5014-00), #6-32 X 3/4" PPH MS (Sems) Zinc (Qty. 3) (237-5504-00), 1/2" X 1/4" Hex Spacer #6-32 Tap (Qty. 1) (254-5008-03) and #6-32 X 1/4" PPH MS (Sems) Zinc (Qty. 2) (232-5200-00)																			
7	RF Shield	1	820-5092-00	ORDER ONLY INDIVIDUAL PART(S) NEEDED:															
Item 7 is secured inbetween: *Item 6* and its' mounting hardware described.																			
8*	Ground Strap (25") (on Items 4, 6, 12)	4	600-5006-25	AP-A1	Clear Backglass 25.906" X 19.187"	1	660-5038-02												
9*	1/2" Clamp (Single) (on Item 4)	1	040-5000-06	AP-A2	MONOPOLY® Film Art (Game Nº 75)	1	830-5275-00												
10*	Ribbon Cable, 14-Pin	1	036-5260-00	AP-A3	Top Plastic Channel - 26"	1	545-5018-15												
Item 10 Note: The 14-Pin cable connects the Dot Matrix Disp. Bd. to the Disp. Controller Bd.																			
11*	Foam 3/16" Thk. X 1/4" X 36"	6	626-5026-00	AP-A4	Bottom Plastic Lift Channel - 26-1/16"	1	545-5021-01												
Above Item 11 is self-adhesive. Located between Items 3 & 17. Sold in 12" Lengths only.																			
12	Speaker (Shld.) 4" 8Ω MG Elec #4060SH	2	031-5004-01	AP-A5	Plastic Edging (Left/Right) - 18-1/8"	2	545-5018-14												
13	Speaker Grill (Black w/no Artwork)	2	535-8081-01	AP-A6*	Tape (double-sided) (12" Length)	1/2	626-5005-00												
14	Speaker Panel Hook Bracket	2	535-7009-02	Note: AP-A6 secures AP-A5 to AP-A1															
Items 12, 13 & 14 are secured by: #8 X 3/4" HWH AB (Zinc) (Items 12/13: Qty. 4/per; Item 14: Qty. 2/per) (234-5103-00)																			
<table border="1"> <thead> <tr> <th>Nº</th> <th>INDIVIDUAL PART NAME</th> <th>QTY.</th> <th>SPI PART Nº</th> </tr> </thead> <tbody> <tr> <td>AP-B</td> <td>Pivot Hinge Left</td> <td>1</td> <td>535-7999-00</td> </tr> <tr> <td>AP-C</td> <td>Pivot Hinge Right</td> <td>1</td> <td>535-7999-01</td> </tr> </tbody> </table>								Nº	INDIVIDUAL PART NAME	QTY.	SPI PART Nº	AP-B	Pivot Hinge Left	1	535-7999-00	AP-C	Pivot Hinge Right	1	535-7999-01
Nº	INDIVIDUAL PART NAME	QTY.	SPI PART Nº																
AP-B	Pivot Hinge Left	1	535-7999-00																
AP-C	Pivot Hinge Right	1	535-7999-01																
Items AP-B & AP-C are secured to Backbox by: 1/4"-20 X 1-1/4" C.B. Sq. Neck (Qty. 4) (231-5003-00), 1/4"-20 Flange Nut (Qty. 4) (240-5300-00) and Fend Washer 1/4" I.D. X 1" O.D. (Qty. 1) (242-5009-00) Items AP-B & AP-C are secured to Cabinet by: 1/4"-20 X 7/8" Carriage Bolt Sq. Neck (Qty. 2) (231-5014-00); Hinge Spacer (Qty. 2) (530-5099-00), Washer 1/4" I.D. X 7/8" O.D. X 1/8" Yellow (Qty. 1/per) (242-5016-01), Fend Washer 1/4" I.D. X 1" O.D. (Qty. 1/per) (242-5009-00) and 1/4"-20 Flange Nut (Qty. 1/per) (240-5300-00)																			

Sec. 4: Parts Id. ...



Cabinet - General Parts ■ & Switches □

For Backbox Parts see the previous two pages.

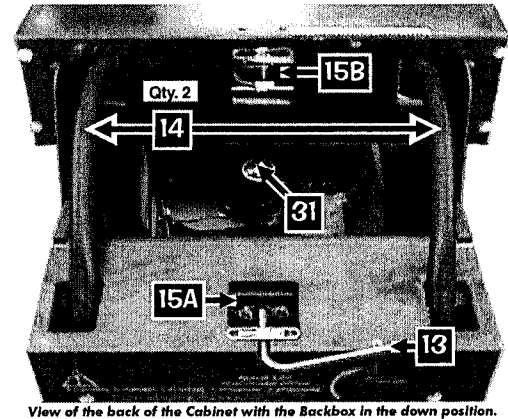
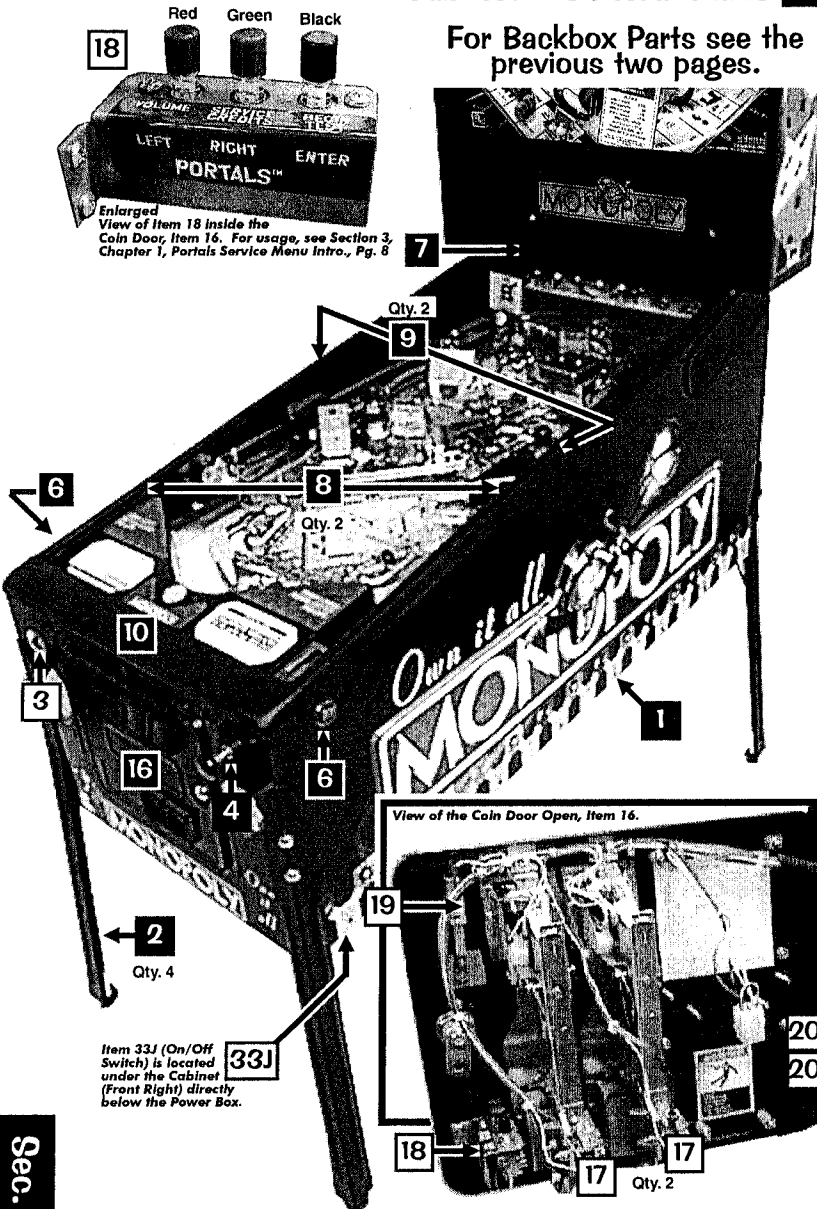

View of the back of the Cabinet with the Backbox in the down position.

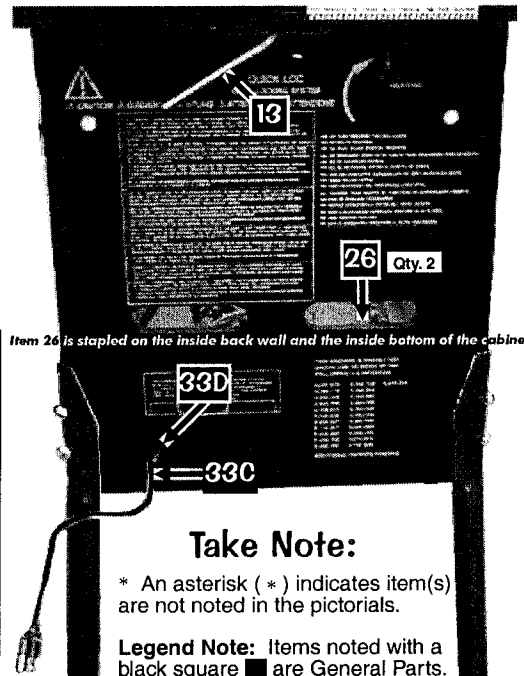

Item 26 is stapled on the inside back wall and the inside bottom of the cabinet.

Take Note:

* An asterisk (*) indicates item(s) are not noted in the pictorials.

Legend Note: Items noted with a black square ■ are General Parts. Items noted with a white square □ are Switches.

Sec. 4: Parts Id. ...

Nº	CABINET PART NAME	QTY.	SPI PART Nº	Nº	CABINET PART NAME	QTY.	SPI PART Nº
1	Game Nº 75 Screened Cabinet (Plain)	1	525-6000-75	12*	P/F Glass (Tmprd.) 21" X 43" X 3/16"	1	660-5001-00
2	Black Leg & Leveler Assembly	4	500-5921-50	13	Hex Key Allen Wrench 5/16"	1	777-0001-00
Item 2 is secured by: Leg Bolt Back Plate (535-5703-00) and Leg Bolt 3/8" X 16 X 2-1/2" Hex 5/8" Hd. (2/per) (231-5001-01) To order just a Leg Leveler (3/8" - 16 X 3") use SPI Nº: 500-5017-00. A Leg "without" a Leg Leveler is not available.							
3	Start Red Button Assy. ("Flipper" Style)	1	500-6090-02	14	Corrugated Tubing Black 1 1/4" Ø X 2.6' Lg.	2	605-5008-00
Item 3 includes the Switch. FOR SWITCH ONLY see Item 25 on the Next Page.							
4	Ball Shooter (Plunger) Assembly	1	500-6146-00-04	15A	#1 Roto Lock Male	1	355-5006-01
Item 4 is secured by: Support Plate (Qty. 1) (535-5027-00), #10-32 X 3/8" SHWH (Serr) Swage (Qty. 3) (237-5985-00) and #6 X 5/8" HWH AB (Zinc) (Qty. 2) (234-5002-00). FOR A BREAKDOWN OF PARTS SEE: Sec. 4, Chp. 2, Drawings..., Page 66.							
5	1" Ø Round Red Button Lighted	0	Not Used	15B	#1 Roto Lock Female (on Backbox)	1	355-5006-02
Item 5 includes the Switch. FOR SWITCH ONLY see Item 25 on the Next Page.							
6	Flipper Red Button Assembly	2	500-5026-32	Item 15A is secured by: #10-24 X 1-3/4" Carr. Bolt Sq. Neck (Qty. 2) (231-5022-00), #10-24 Nylon Stop Nut (Qty. 2) (240-5206-00) and #10 Washer 7/32" X .5" X 1/16" (Qty. 2) (242-5003-00)			
Item 6 is secured by: Pal Nut for Flipper Button (Metal) (Qty. 2) (240-5003-01) and is fitted with: O-Ring 11/32" X 7/32" X 1/16" (Qty. 1/per) (545-5850-00) Item 6 DOES NOT include the Switch. FOR SWITCHES ONLY see Items 23A/B on the Next Page.							
7	Rear Glass Channel 20-3/8" Length	1	545-5038-00	16	Coin Door (with Validator) USA only	1	500-5018-172
8	Plastic Channel 42-5/8" Lg. (Lt. & Rt.)	2	545-5017-00	Item 16 is secured by: 1/4"-20 X 1-1/4" Carriage Bolt Sq. Neck (Qty. 4) (231-5003-00) 1/4"-20 Flange Nut (Qty. 4) (240-5300-00) and Fend Washer 1/4" I.D. X 1" O.D. (Qty. 3) (242-5009-00) NOTE: For Coin Door other than USA call Technical Support for SPI Part Nº.			
9	Side Armor "with holes" (Lt. & Rt.)	2	535-7297-02	17	Coin Door Switch (USA)	2	180-5024-00
Item 9 is secured by: #10-24 X 1" Carriage Bolt Sq. Neck (2/per) (231-5021-00), #10-24 Hex Nut (2/per) (240-5202-00) and #8 X 5/8" T20 Tmp. Prt. (2/per) (237-5947-00)							
10	Front Molding - Black	1	500-5757-01-00	18	Coin Door Switch (¥ Japan)	0	180-5091-00
11*	Foam Rubber 3/8" X 3/16" X 20-3/8"	1	626-5001-00	18	Diagnostics Service Switches (X3)	1	180-5012-03
Above Item 11 is self-adhesive. It is located on Item 10. Sold in 12" Lengths only.							
				19	Slam Tilt Switch (On Coin Door)	1	180-5022-00
				20	Dual Switch Assembly	1	500-5808-00
ORDERING ABOVE (ITEM 20) ASSEMBLY PART Nº WILL INCLUDE:							
				20A	Mounting Bracket	1	535-6958-00
				20B	Playfield Power Interlock Sw. (Top)	1	180-5136-00
				20C	Memory Protect Switch (Bottom)	1	180-5000-00
Item 20 is secured to Cabinet by: #8 X 1/2" SHWH AB (Zinc) (Qty. 2) (234-5101-00)							

Parts Table & Views continue on the next page.



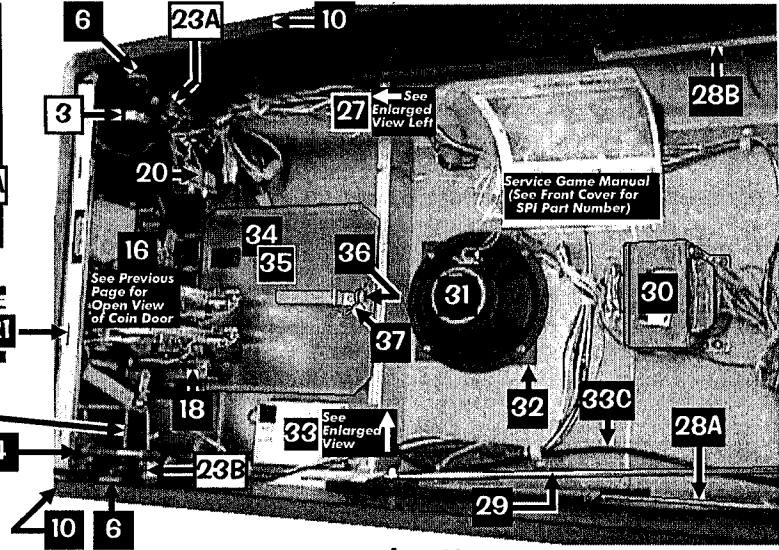
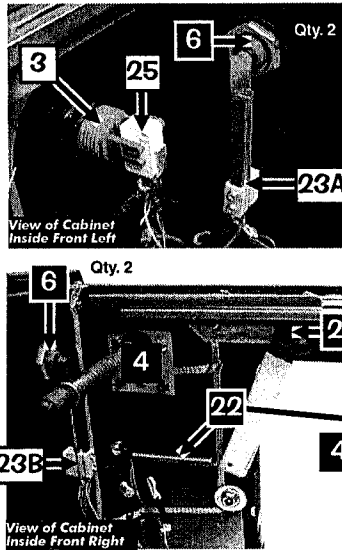
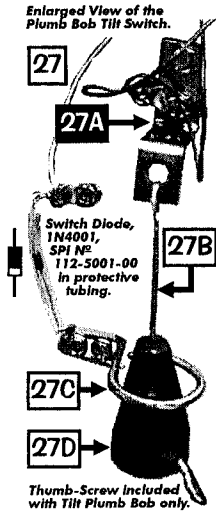
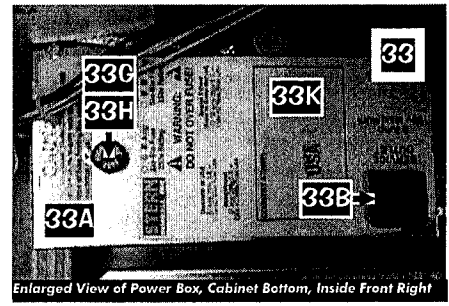
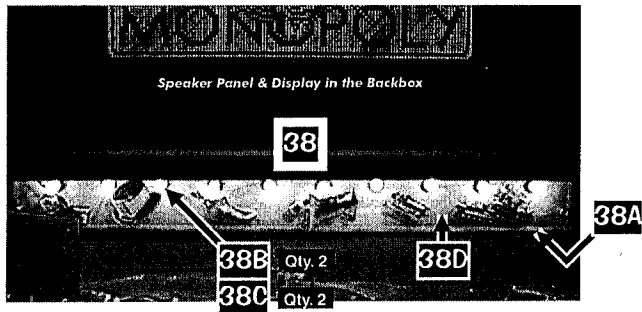

Take Note:

* An asterisk (*) indicates item(s) are not noted in the pictorials.

Legend Note: Items noted with a black square ■ are General Parts. Items noted with a white square □ are Switches.

Nº	INDIVIDUAL PART NAME	QTY.	SPI PART Nº
<i>Parts Table & Views continue on the previous page.</i>			
21	Front Molding Lockdown Assembly	1	500-5020-01
Item 21 is secured by: #10-24 X 1-1/4" Carr. Bolt (Qty. 2) (231-5012-00), #10-24 Keps Nut (Qty. 2) (240-5207-00), #8 X 5/8" HWH AB Zinc (Qty. 4) (234-5102-04) and #10 Washer 7/32" ID X 1/2" OD X 1/16" (Qty. 2) (242-5003-00)			
22	Lockdown Spring (connected to handle)	1	265-5008-00
23A	Flipper Switch - Self-Cleaning	1	180-5160-00
23B	Flipper Sw. - X2 Stack for Lwr./Upr. Flipper(s)	1	180-5164-00
24*	Foam Strip (2 on 23A; 1 on 23B)	3	626-5042-00
25	Start Button (SWITCH ONLY)	1	180-5174-00
26	Grills 2-1/2" X 18" (on Back & Bottom)	2	545-5072-02
27	Cabinet Plumb Bob Tilt Switch	1	See Parts Below
ORDER ONLY INDIVIDUAL PART(S) NEEDED:			
27A	Bracket for Hanger Wire	1	535-5221-00
27B	Hanger Wire	1	535-5319-00
27C	Contact Wire Form	1	535-7563-01
27D	Plumb Bob Weight (Includes Thumb-Screw)	1	535-5029-00
Items 27A & 27C are secured by: #8 X 1/2" SHWH AB (Zinc) (Qty. 4) (234-5101-00)			
28A	Slide & Pivot Support Bracket - Right	1	535-5990-00
28B	Slide & Pivot Support Bracket - Left	1	535-5989-00
Items 28A & 28B are secured by: #10-24 X 1-1/4" Carriage Bolt Sq. Neck (3/per) (231-5012-00) and #10-24 KEPS Nut (3/per) (240-5207-00)			
29	Prop Rod	1	535-7553-00
Item 29 is secured by: #10-24 X 1-3/4" Carriage Bolt Sq. Neck (Qty. 1) (231-5022-00), Washer #10 7/32" ID X .5" OD X 1/16" Thk (Qty. 1) (242-5003-00) and #10-24 Nylon Stop Nut (Qty. 1) (240-5206-00)			
30	Transformer 5.7v AC (with Ballast Winding)	1	010-5012-01
Item 30 is secured by: 1/4"-20 X 5/8" PPH MS (Zinc) (Qty. 4) (237-5854-00) and 1/4" Split Lock Washer (Qty. 4) (244-5000-00)			

Nº	INDIVIDUAL PART NAME	QTY.	SPI PART Nº
31	Speaker 8" ø Rd. 8010 4Ω	1	031-5007-00
32	Speaker Grill 7" X 7"	1	545-5072-03
Items 31 & 32 are secured by: #6-32 X 1-1/4" Fin Shark Screw (Qty. 4) (237-5883-00) and #6-32 Keps Nut (Qty. 4) (240-5008-00)			
33	Power Input Box Sub-Assy.	1	515-5360-07
ORDERING ABOVE (ITEM 33) SUB-ASSY. PART Nº WILL INCLUDE:			
33A	Power Box (Plain)	1	535-5932-00
33B	Service Outlet (for USA)	1	180-5008-01
33C	Line Cord 10' ROJ 3" Max.	1	034-5000-10
33D	Recessed Cup for Line Cord	1	545-5122-00
33E*	Line Filter	1	150-5000-00
33F*	Varistor TNR159211KM	1	150-5001-00
33G	Fuse 8 Amp 250v Slo-Blo (Domestic)	1	200-5000-05
33H	Fuse Holder	1	205-5001-00
33I*	On/Off Switch Bracket	1	535-8318-00
33J	On/Off Rocker Sw. (Arcoelectric C1350AB)	1	180-5001-01
33K	Power Box Decal	1	820-6123-03
34	Cash Box Plastic Bottom	1	545-5090-00
35	Cash Box Cover (Validator)	1	535-5013-03
36	Cash Box Lock Bracket (wire)	1	535-7562-00
37	Large Hair-Pin Clip	1	535-7772-00
38	Cabinet Light Bd. Assy. MONOPOLY®	1	500-6413-75
ORDERING ABOVE (ITEM 38) ASSEMBLY PART Nº WILL INCLUDE:			
38A	Cabinet Light Board Plain (Generic)	1	525-5570-00
38B	2-Lug Stand-Up Long Shell Socket	10	077-5031-00
38C	#44 Bulb Yellow (Small Bayonet Type)	10	165-5053-06
38D	Decal for Item 38A	1	820-6287-01
Item 38B is secured to Item 38A by: #6 X 3/8" HWH AB Zinc (Qty. 1/2 pair) (234-5000-00)			
Item 38 is secured to the Cabinet by: #8-32 X 1 1/2" HWH MS (Ser) Zinc (Qty. 2) (237-5946-00) and #8 Washer (Qty. 2) (242-5005-00)			
Ordering Note: If 500-6413-75 is unavailable, order the individual part(s) actually required.			

Sec. 4: Parts Id. ...



Playfield - General Parts & Switches (Below)

Nº	BELOW PLAYFIELD PART NAME	QTY.	SPI PART Nº
1	Playfield Support Slide Bracket	2	535-6862-02
Item 1 is secured by: #8 X 1/2" SHWH AB (Zinc) (Qty. 2/per) (234-5101-00) and #8-32 X 5/8" HWH Swage (Serr) Zinc (Qty. 1/per) (237-5975-03)			
2	Edge Slide Bracket (Extended)	2	535-5988-01
Item 2 is secured by: #4 X 1/2" PFH (Zinc) (Qty. 5/per) (237-5840-00)			
3	Pivot Pin Bracket Welded Assembly	2	500-5329-03
4	Switch Bracket (Shooter Lane / Eject Holes)	4	535-6173-00
Item 4 is secured by: #6 X 1/2" HWH AB (Zinc) Red (Qty. 2/per) (234-5001-02)			
5	Sw. (3-Ball) Bracket (Lock Ball Lane)	1	535-8842-00
6	Mounting Bracket (for Back Panel)	2	535-8964-00
7	Light Cover Bracket	8	535-8965-00
Item 7 is secured by: #8 X 3/8" HWH AB (Zinc) (Qty. 2/per) (234-5100-00)			
8	Switch Back Plate (Stand-Up Target)	3	535-6452-00
8	Target (Stand-Up) Bracket	3	535-6896-00
9	Lane Divider Bracket	1	535-8972-00
10	Gate Bracket (Left) Assy. (see next page)	1	500-6514-00
11	Gate Bracket (Rt.) Assy. (see next page)	1	500-6515-00
Items 5, 6 & 9-11 are secured by: #8 X 1/2" HWH AB (Zinc) (Qty. 2/per) (234-5101-00)			
12*	Insulation Fiche Paper (under lwr. Flips)	2	545-5721-00
13	Diode Terminal Strip 2-Lug (810) Isolated	1	055-5203-00
14	Diode Terminal Strip 3-Lug (813) Isolated	2	055-5204-03
15	Diode Terminal Strip 5-Lug (824) Isolated	2	055-5204-05
16	Diode Terminal Strip 7-Lug Isolated	2	055-5204-07
Items 13-16 are secured by: #6 X 3/8 HWH AB Zinc (Qty. 1-2/per) (234-5000-00). Note: 1N4004 Diodes (112-5003-00) are used in all Diode applications. 1N4001 Diodes can be used for Switches and/or Lamps. See Sec. 5, Chp. 2, Playfield Diode Terminal Strip...			
17	3A 250v Slo-Blo Fuse	3	200-5000-08
17	Fuse Clip Holder (Socket)	3	205-5000-01
Item 17 is secured by: #6 X 1/2" PPH AB (Qty. 1/per) (237-5805-00) Note: Item 17, Fuse Clip Holder (Socket) 205-5000-01 is part of a set of 12 (205-5000-12). You can order them as individuals (...01) or a set of 12 (...12).			
18*	#8 Solder Lug	7	055-5140-08
Item 18 is secured by: #6 X 3/8" HWH AB (Zinc) Red (Qty. 1/per) (234-5000-00)			

Nº	BELOW SWITCHES PART NAME	QTY.	SPI PART Nº
A	Micro Sw. Roll-Over Left Brkt. Assy.	4	500-6227-01
B	Micro Sw. Roll-Over Right Brkt. Assy.	6	500-6227-02
Items A & B are secured by: #8 X 1/2" HWH AB (Zinc) (Qty. 2/per) (234-5101-00)			
C	Micro Switch (at Shooter Lane)	1	180-5157-00
D	Micro Switch (Short Flat Actuator by Motor)	1	180-5187-00
E	Micro Switch (Long Flat Actuator by Ejects)	2	180-5186-00
F	Micro Switch (Straight Wire Actuator)	1	180-5178-00
G	Micro Switch (Small Bend Wire Actuator)	1	180-5179-00
H	Micro Switch (Large Bend Wire Actuator)	1	180-5180-00
Items C-H require a Switch Body Protect Plate (535-6539-00) which is secured by: #2-56 X 1/2" HWH Serr (Qty. 2) (237-5937-02) and #2-56 Hex Nut (Qty. 2) (240-5301-00).			
I	Switch & Target Assy. Square (Yel)	3	515-5162-06
Item I is secured by: #8 X 1/2" HWH AB (Zinc) (Qty. 2/per) (234-5101-00) For better views or entire assembly, see Appendix I, Page A14 (end of manual).			
J	Micro Switch (Bumpers)	6	180-5015-03
K	Stack (Blade) Switch (Slingshots)	4	180-5054-00
L	Micro Switch (Roller Actuator) (on Motor)	1	180-5119-00
M	Micro Sw. (Roller Actuator, Lite) (Ball Trough)	3	180-5119-02
N	EOS Switch Flipper (Lower Flippers)	2	180-5149-00
O	Micro Switch (Drop Target)	1	180-5158-00
P	Micro Switch (Scoop)	1	180-5183-00
Note: For how Items J-P are secured or for a better view, see Sec. 4, Chp. 2, Drawings for Major Assemblies & Ramps, Item J, Page 71; Item K, Page 72 (top); Item L, Page 80; Item M, Page 67; Item N, Pages 68-69; Item O, Pages 76-76; Item P, Page 75.			

Nº	BELOW MISC. PCB PART NAME	QTY.	SPI PART Nº
Q	Dual OPTO TRANS Bd. (on Ball Trough)	1	520-5173-00
Q	Dual OPTO REC Board (on Ball Trough)	1	520-5174-00
R	4-Position OPTO (Receiver) PC Board	1	520-5210-00
Item R is secured by: #6 X 7/8" HWH AB (Zinc) (Qty. 2) (234-5003-01) and 3/8" Sil. Rin. Spacer White (Qty. 4) (254-5007-01)			
Note: For more details on Items Q & R and a break-down of parts, see Section 5, Chapter 4, Printed Circuit Boards, Pages 99 & 130. For how Item Q is secured or for a better view, see Sec. 4, Chp. 2, Drawings for Major Assemblies & Ramps, Page 67.			
S	DC Relay (Bi-Directional) PC Board	1	520-5066-00
Item S is secured by: #6 X 3/4" HWH AB (Zinc) (Qty. 4) (234-5003-00) and 3/8" Sil. Rin. Spacer White (Qty. 4) (254-5007-01)			

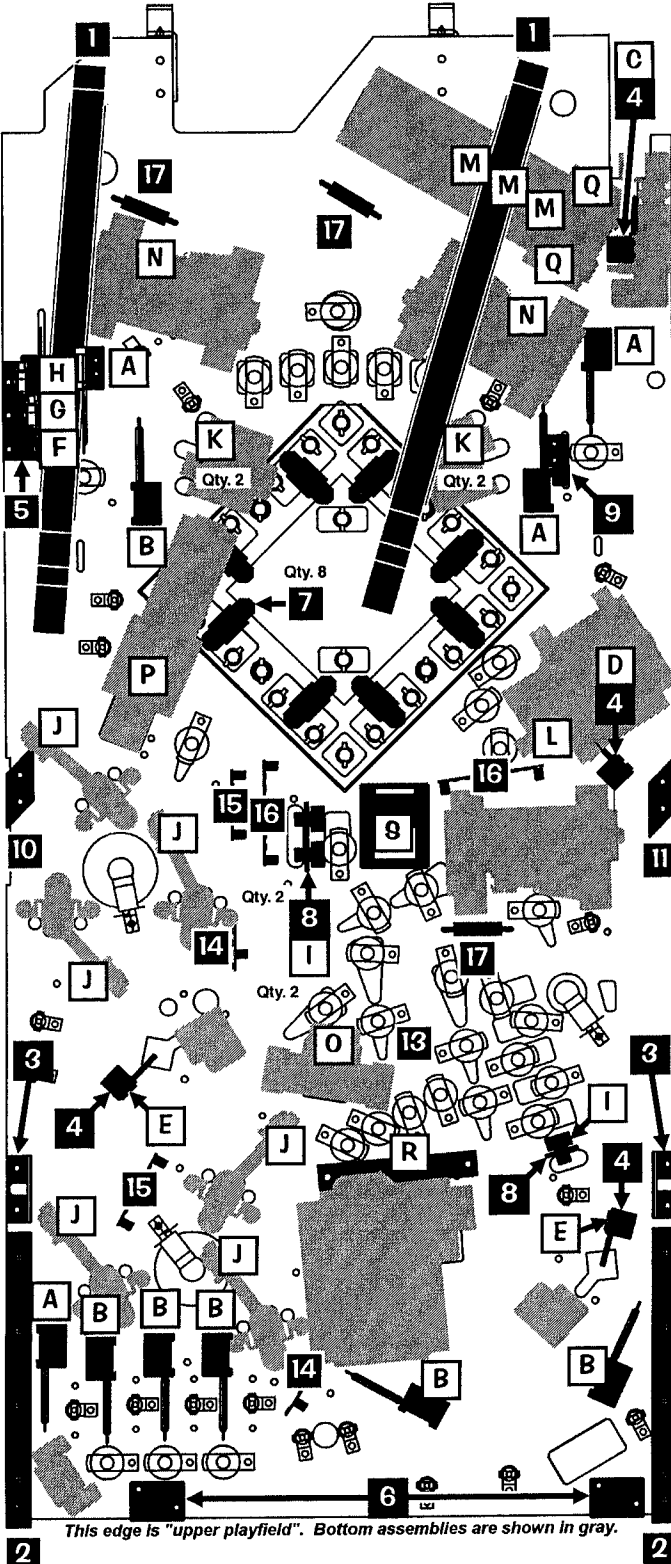

Sec. 4: Parts Id. ...

Take Note:

- * An asterisk (*) indicates item(s) are not noted in the pictorials.
- 1. For Sockets & Bulbs (drawings & part numbers) see Pgs. 62-64.
- 2. Some items or parts may be included with or associated with a Major Assembly or Ramp Assembly; see the Blue Pages, Sec. 4, Chp. 2. for parts required not appearing on this page. If you still cannot find the part required, Call Stern™ Pinball Technical Support, 1-800-542-5377 or 1-708-345-7700.
- 3. Legend Note: Items noted with a black square ■ are General Parts. Items noted with a white square □ are Switches, OPTO Boards, or Misc. PC Boards.



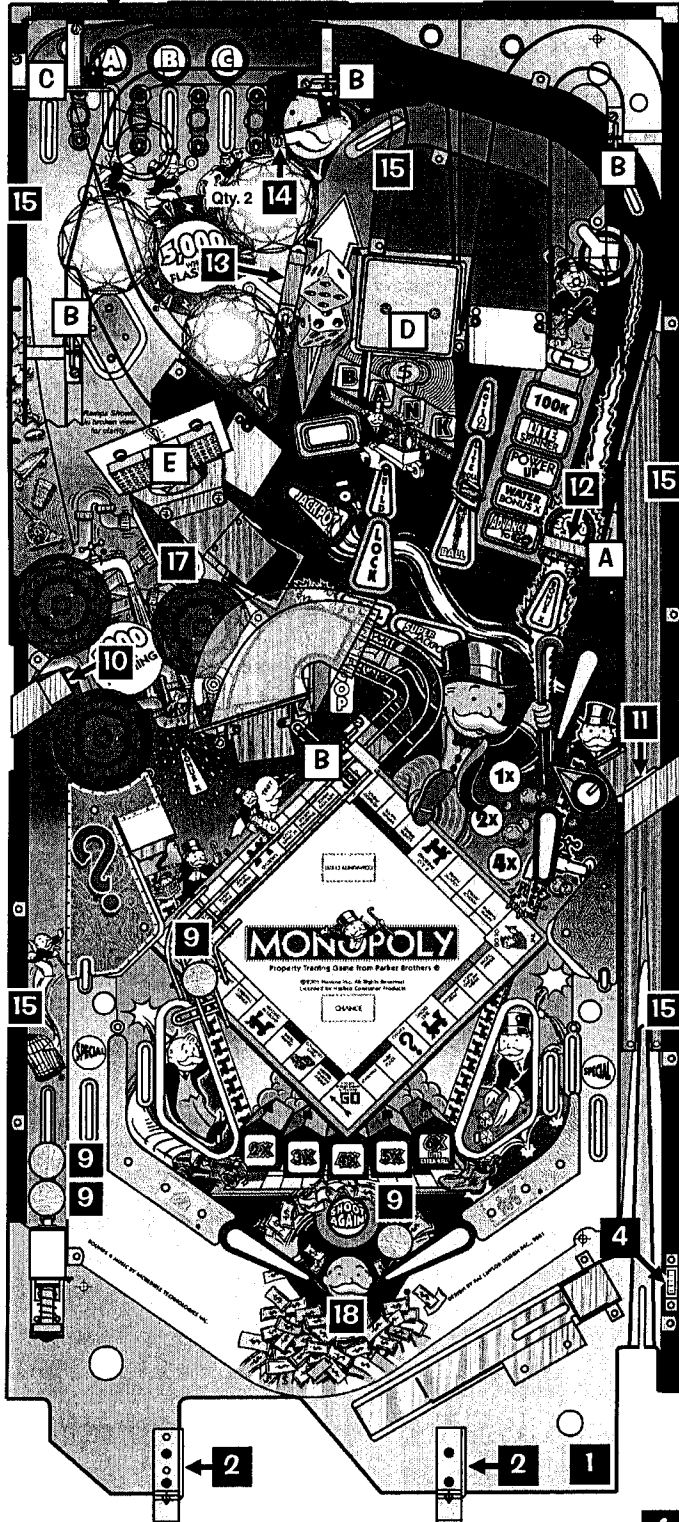

Nº	ABOVE PLAYFIELD PART NAME	QTY.	SPI PART Nº
1	P/F Screened w/ Inserts & NO Parts	1	830-5100-75
1	P/F Complete w/ Inserts & ALL Parts	1	505-6004-75-75
2	Playfield Hanger Bracket	2	535-8385-00
Item 2 is secured to the P/F by: #8-32 X 7/8" HWH MS Zinc (Qty. 2/per) (237-5890-00)			
3	Bottom Arch (Black Plastic)	1	545-5995-00
Item 3 is secured to the playfield by: Playfield Support Hex Post (double male threaded end #8-32 (Qty. 2) (530-5285-00) [see Page 59, Item 15 for view], #8 Washer (Qty. 2) (242-5005-00) and #8-32 Nylon Stop Nut (Qty. 2) (240-5102-00).			
Note: For Decals, see Playfield - Plastics, Metal Covers, Mylar & Decals, Page 57.			
4	Level Assembly	1	515-7214-00
For Individual Items use: #82 8MM Vial Mig. Flange (545-6027-00) or Level Bracket (535-9010-00). Flange secured by: #6-32 X 1/4" PPH MS (no Sems) Zinc (Qty. 1) (237-5500-00) and #6-32 Keps Nut (Qty. 1) (240-5008-00) and Bracket secured to the wood rail by: #6 X 1/2" HWH AB Zinc Red (Qty. 2) 234-5001-02 (Qty. 2) (234-5001-02)			
5	Instruction Card (USA) Nº: 75	1	755-5175-00
Note: Visit www.sternpinball.com for a PDF copy of the Game Instruction Card which will contain any translated instruction cards made for this game. Find Game Link or Archives.			
6	Coin Card (1-Sided)	1	755-5087-05
Note: Use Item 6 (Side 1: 1 Play 50¢ - 5 Plays \$2) for Adj. 7, Game Pricing, USA 5 Setting.			
7	Coin Card (2-Sided)	1	755-5087-01
Note: Use Item 7 (Side 1: 1 Play 50¢ - 3 Plays \$1) for Adj. 7, Game Pricing, USA 8 Setting; Use Item 5 (Side 2: 1 Play 50¢) for USA 3 Setting.			
8	OPTIONAL Coin Card (1-Sided)	0	755-5087-02
Note: Use Item 8 OPTIONAL (Blank) for Custom Settings (NOT INCLUDED in USA or Foreign Games w/own Country Coin Card, Item 8 is available, call your local Distributor).			
9	Pinball (Steel) 1 1/8" ø	4	260-5000-00
10	Gate Bracket (Left) Assembly	1	500-6514-00
Includes: Bracket LT (535-8976-00), LT Flap (535-8978-00) & Hinge Pin LT (535-8981-00)			
11	Gate Bracket (Right) Assembly	1	500-6515-00
Includes: Bracket RT (535-8977-00), RT Flap (535-8979-00) & Hinge Pin RT (535-8982-00)			
Items 10 & 11 are secured under the playfield by: #8 X 1/2" HWH AB (Zinc) (Qty. 2/per) (234-5101-00)			
	Spinner Sub-Assembly	1	515-5553-00
12	Spinner Bracket	1	535-8952-00
	Decal	2	820-5215-00
	1-Way Gate Mounting Bracket (Small)	1	535-5269-03
13	Wire Gate (for above)	1	535-5307-03
Item 13 is secured by: #6-32 X 3/8" PPH MS (Sems) Zinc (Qty. 1) (232-5201-00) and #6-32 Nylon Stop Nut (Qty. 1) (240-5005-00)			
14	Bracket, Sign Mounting (Short)	2	535-8912-00
Item 14 is riveted to Screened Plastic -20 by: Rivet, 1/8" ø X 3/16" Lg. (Nickel) (Qty. 1/per) (249-5001-00) and #6 Riveting Lock Washer (Qty. 1/per) (246-5000-00) and secured to Screen Plastic -13 by: #8-32 Nylon Stop Nut (Qty. 1/per) (240-5102-00)			
15	Ramp Mounting Welded Bracket	5	515-6508-00
Item 15 is secured by: #6 X 1/2" PTH A (Zinc) (Qty. 2/per) (237-5809-00)			
16	Back Panel Red Wood (No Parts)	1	525-5593-00
Item 16 is secured by: See Mounting Brackets (Back Panel) on previous page.			
17	1/2" Clamp (Single) (on Scr. Plastic -08)	1	040-5000-06
18	Plug-Cap (3/16") Black Plastic	1	545-5232-01
Note: Item 18 should plug hole if the Center Post (@ Drain) is Not Used.			

Nº	ABOVE SWITCHES PART NAME	QTY.	SPI PART Nº
A	Micro Switch (Spinner)	1	180-5010-04
Item A requires a Switch Body Protect Plate (535-6539-00) which is secured by: #2-56 X 1/2" HWH Serr. (Qty. 2) (237-5937-02) and #2-56 Hex Nut (Qty. 2) (240-5301-00).			
B	Micro Switch (on Roll-Under Gates on Ramps)	4	180-5087-00
C	Switch & Target Assy. Narrow (Yellow)	1	515-5967-06
Note: For how Item C is secured & for a better view or complete assembly, see Section 4, Chapter 2, Drawings for Major Assemblies & Ramps, Pages 82-83.			

Nº	ABOVE MISC. PCB PART NAME	QTY.	SPI PART Nº
D	4-Position OPTO (Transmitter) PCB	1	520-5218-00
E	Dot Display (5X7) x3 PC Board	1	520-5197-00
Note: For more details on items D & E and a break-down of parts, see Sec. 5, Chapter 4, Printed Circuit Boards, Pages 131 & 133. For how Items D & E are secured or for a better view, see Section 4, Chapter 2, Drawings for Major Assemblies & Ramps, Item D, Page 87; Item E, Page 79.			

Take Note:

- Some items or parts may be included with or associated with a Major Assembly or Ramp Assembly; see the Blue Pages, Sec. 4, Chp. 2, for parts required not appearing on this page. If you still cannot find the part required, Call Stern™ Pinball Technical Support, 1-800-542-5377 or 1-708-345-7700.
- Legend Note:** Items noted with a black square ■ are General Parts. Items noted with a white square □ are Switches.

Sec. 4: Parts Id. ...



- 1 3" I.D.
- 2 2¾" I.D.
- 3 2½" I.D.

Playfield - Rubber Parts □ (Rings Actual Size) †

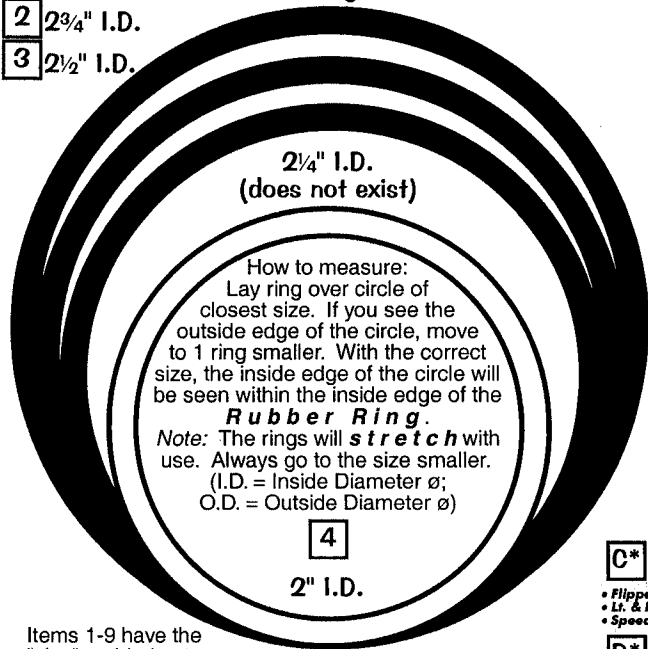

Items 1-9 have the "size" molded onto the Rubber Ring.

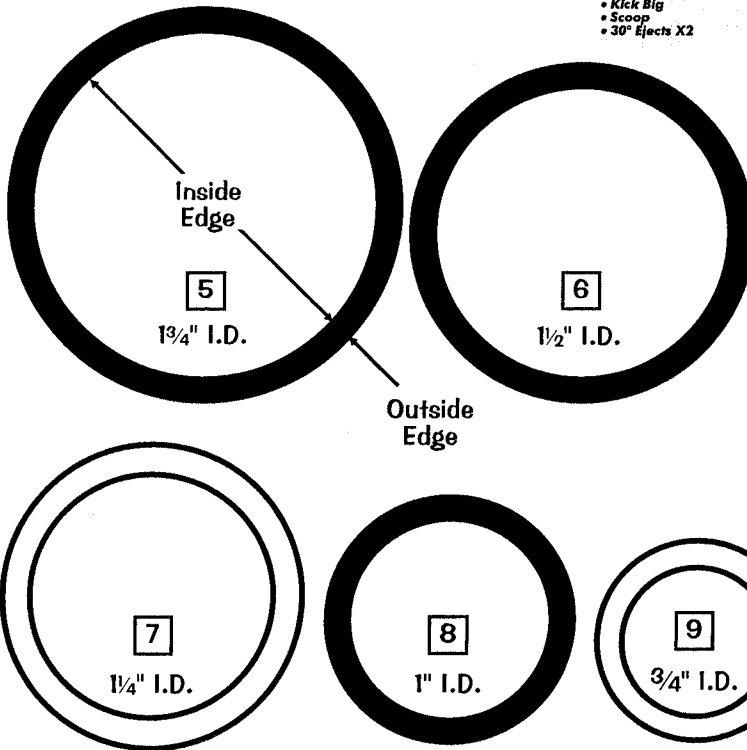

- C*** Not Shown: Qty. 8
- Flipper Assemblies
- Lt. & Rt. Plas. Ramps
- Speed Bump Ramp
- D*** Not Shown: Qty. 1 Per
- Trough Up-Kicker
- Kick Big
- Scoop
- 30° Ejects X2

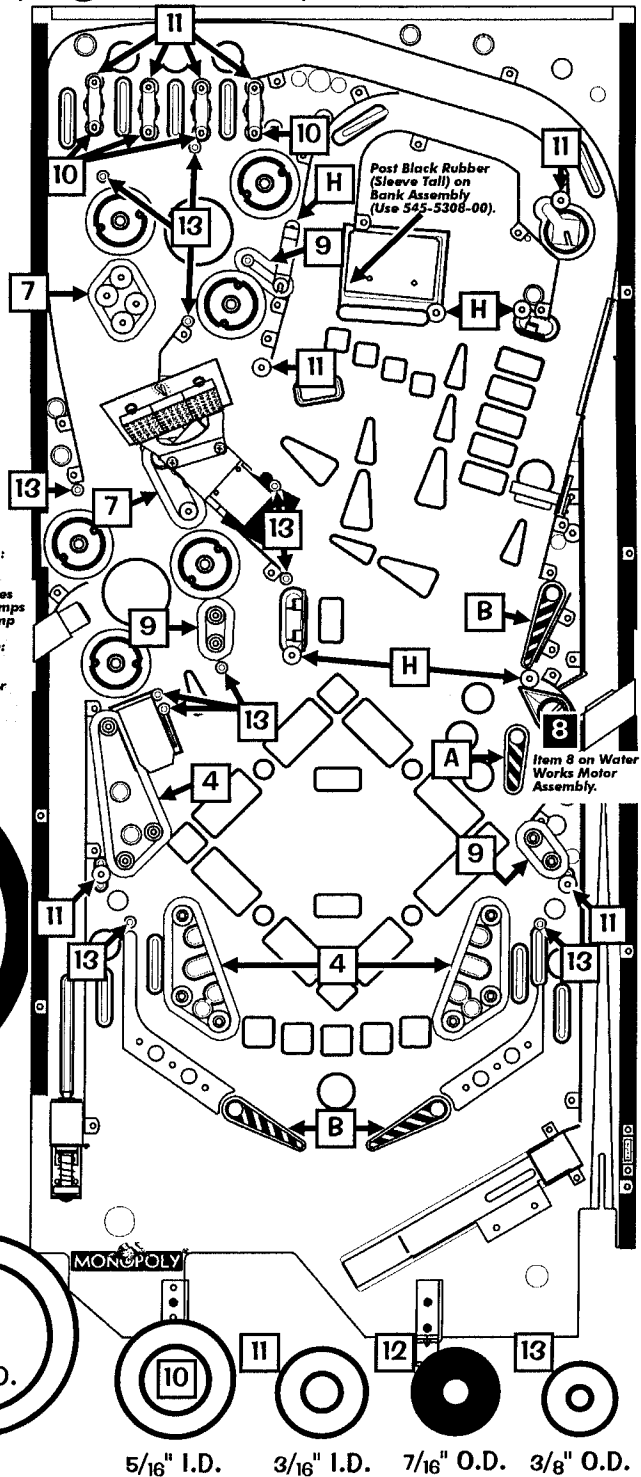

Sec. 4: Parts Id. ...

Nº	RUBBER PART NAME	QTY.	SPI PART Nº	Nº	RUBBER PART NAME	QTY.	SPI PART Nº
A	Small Flipper RED Rubber Ring	1	545-5207-00	4	2" I.D. WHITE Rubber Ring	3	545-5348-58
B	Large Flipper RED Rubber Ring	3	545-5277-00	5	1¾" I.D. BLACK Rubber Ring	0	545-5348-21
C*	Deflector Pad (Bumper) BLK Rubber	8	545-5428-00	6	1½" I.D. BLACK Rubber Ring	0	545-5348-07
D*	Rubber Bumper (Grommet)	5	545-5105-00	7	1¼" I.D. WHITE Rubber Ring	2	545-5348-56
E	Bumper Post Rubber	0	545-5009-00	8	1" I.D. BLACK Rubber Ring	1	545-5348-05
F	Rubber Flange Bumper	0	545-5965-00	9	¾" I.D. WHITE Rubber Ring	3	545-5348-54
G	Post Rubber (Sleeve Short)	0	545-5151-00	10	5/16" I.D. WHITE Rubber Ring	4	545-5348-52
H	Post WHITE Rubber (Sleeve Tall)	6	545-5308-08	11	3/16" I.D. WHITE Rubber Ring	7	545-5348-51
1	3" I.D. BLACK Rubber Ring	0	545-5348-10	12	7/16" O.D. BLACK Rubber Ring	0	545-5348-17
2	2¾" I.D. BLACK Rubber Ring	0	545-5348-20	13	3/8" O.D. WHITE Rubber Ring	11	545-5348-69
3	2½" I.D. BLACK Rubber Ring	0	545-5348-09	14	O-Ring 11/32" X 7/32" X 1/16"	0	545-5850-00

† Items with Ø Qty. are not used in this game. Size and/or quantities may change during production.



Playfield - Plastics (Screened  & Clear ) & Decals (Not Shown)*



See Note 3.

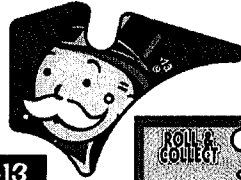

-13



-20

See Note 3.

-12



Qty. 6
-4

See Note 3.

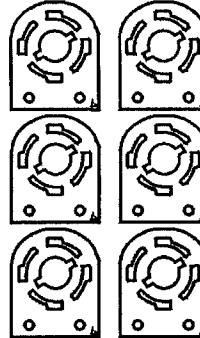

-10

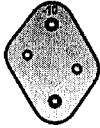

-11

-19



See Note 4.



See Note 3.

-21

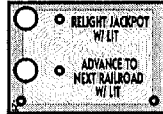

-08

-07

See Note 3.

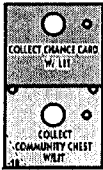

-18

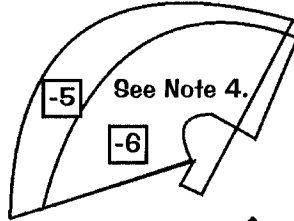

See Note 4.

-5

-6

Qty. 3
-2

See Note 4.

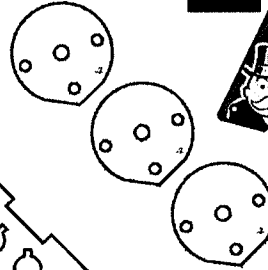

-09

-05

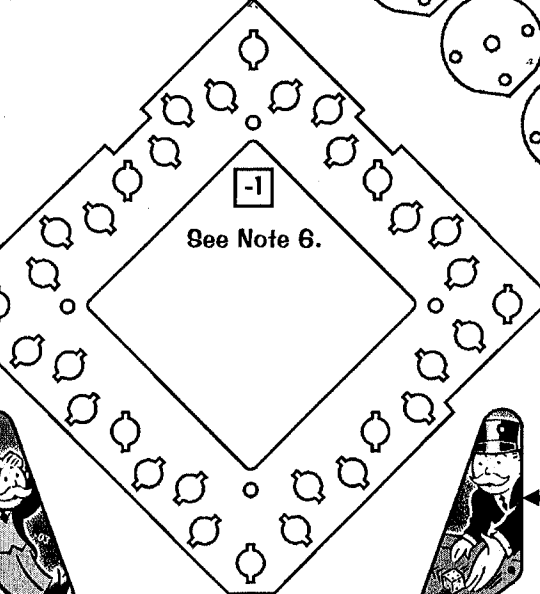

See Note 6.

-1

-03

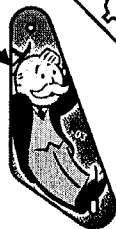

-01

-GA



See Note 5.

-06



-04

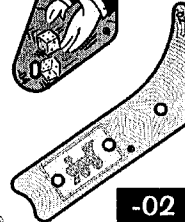

-02





-GB

Nº	SCREENED PLASTIC PART NAME	SPI PART Nº
	MONOPOLY® Screened Plastic Set	830-5985-XX
	MONOPOLY® Clear Plastic Set	830-5987-XX

Attention: Individual Pieces are not be available.
The entire plastic sheet set must be ordered.

Take Note:

- To order the entire Plastic Sheet Set (Screened & Clear), use the above Part Number with the "-XX" ending.
- Legend Note:** Items noted with a black square  are Screened. Items noted with a white square  are Clear.
- The following Plastic Pieces require riveting, if replaced:
-20 (Roll & Collect/Extra Ball), see Page 55 (Item 14) for brackets & securing hardware.
-18 (Collect Chance...) & -22 (Free Parking), see Pages 82 & 83 for brackets & securing hardware.
-4 (Clear: Flash Lamp Mounts) see Pgs. 82-85 for securing hardware.
-21 (Relight Jackpot...), see Page 86 for brackets & securing hardware.
- For bracket(s) and/or securing hardware:
-2 (Clear Driven Wheel), see Page 81.
-5/-6 (Clear Covers), see Page 86.
-19 (Electric Company) see Page 87.
- GA (Key Fob) & -GB (Monopoly Logo) are provided for collecting and are not used in the game.
- If Clear Piece -1 (Lamp Board) requires replacement, **mark the socket and corresponding hole with numbers as to not mix up the lamps.** See Pages 22-23 to verify lamps were put back in the correct order per the Lamp Matrix.

MONOPOLY® DECALS SPI PART Nº

Game 75 Decal Set	820-6287-XX
Left, Center & Right Bottom Arch; Shooter Lane Bottom Arch; Coin Door Monopoly® Logo; "Install 4 Balls"; Portals...; "Bank"; Cop (Drop Target).	
Spinner Decal (Qty. 2)	820-5215-00
DTS A-G (under P/F)	820-6221-75
Miscellaneous (Backbox, Cabinet & P/F):	
Suitable ... Use (UL)	820-6001-01
High Voltage Label (UL)	820-6082-01
Power Box	820-6123-03
Can. UL Listing	820-6141-01
Fuse Label (UL)	820-6143-00
Gen. Backbox Fuse Loc.	820-6152-01
Power	820-6223-00
Protective Earth	820-6224-00
Shock Hazard Label (UL)	820-6263-00
"CAUTION - VERY HOT"	820-6266-00

OPTIONAL MYLAR SPI PART Nº

Optional Clear Playfield Set (Not Included with game)	820-5094-00
--	-------------



Playfield - Rails , Wire Forms , Ball Guides  and Flat Metal Ramps  †

Nº	WOOD RAIL PART NAME	QTY.	SPI PART Nº
1	Wood Rail Left	1	525-5594-00
2	Wood Rail Right	1	525-5595-00

Items 1 & 2 are secured by: #6 X 1-1/4" PFH A (Zinc) (Qty. 6/per) (237-5804-00)

Nº	METAL FLAT RAIL PART NAME	QTY.	SPI PART Nº
3	Metal Flat Rail (Shooter Lane Left, Lower)	1	535-8933-00
4	Metal Flat Rail (Behind Mini-Flipper)	1	535-8934-00
5	Metal Flat Rail (Shooter Lane Right)	1	535-8935-00
6	Metal Flat Rail (Shooter Ramp Left, Upper)	1	535-8936-00
7	Metal Flat Rail (2.6", Behind Upr. Flipper)	1	535-8937-00
8	Metal Flat Rail (Full Top Left to Right Orbit)	1	535-8939-00
9	Metal Flat Rail (Dice Eject Lane, Lower)	1	535-8940-00
10	Metal Flat Rail (Dice Eject Lane, Upper)	1	535-8942-00
11	Metal Flat Rail (Dice Eject Lane, Left)	1	535-8943-00
12	Metal Flat Rail (2.2", Upper Bot. Pop, Rt.)	1	535-8944-00
13	Metal Flat Rail (Upper Bottom Pop Left)	1	535-8945-00
14	Metal Flat Rail (Ball Lock Lane, Right)	1	535-8948-00
15	Metal Flat Rail (Ball Lock Lane, Left)	1	535-8949-00
16	Metal Flat Rail (Center Drain, under Arch)	1	535-8393-00

Items 3-16 are secured at Tabs by: #8 X 1/2" HWH AB (Zc.) (Qty. 1/per tab) (234-5101-00)

Nº	MISC. PART NAME	QTY.	SPI PART Nº
17	Lane Divider Bracket	1	535-8972-00

Item 17 is secured under the playfield by: #8 X 1/2" HWH AB (Zc.) (Qty. 2) (234-5101-00)

Nº	WIRE FORM PART NAME	QTY.	SPI PART Nº
A	Snubber Wire	1	535-5373-02

Nº	BALL GUIDE RAIL PART NAME	QTY.	SPI PART Nº
B	Ball Guide (Steel) Return Lane Left	1	535-8950-00
C	Ball Guide (Steel) Return Lane Right	1	535-8951-00

Items B & C are secured onto posts by: #6-32 Nylon Stop Nut (Qty. 3/per) (240-5005-00)

Nº	FLAT RAMPS PART NAME	QTY.	SPI PART Nº
D	Shooter Lane Ramp	1	535-8938-00

Item D is secured by: #8 X 1/2" HWH AB (Zinc) (Qty. 2) (234-5101-00) and #4 X 1/2" PFH (Zinc) (Qty. 2) (237-5840-00)

E	Speed Bump Metal Ramp Riv. Assy.	1	515-7202-00
---	----------------------------------	---	-------------

Note on Item E: For securing hardware and a break-down of parts on this item, see the Blue Pages, Sec. 4, Chp. 2, Drawings for Major Assemblies & Ramps, Page 87.

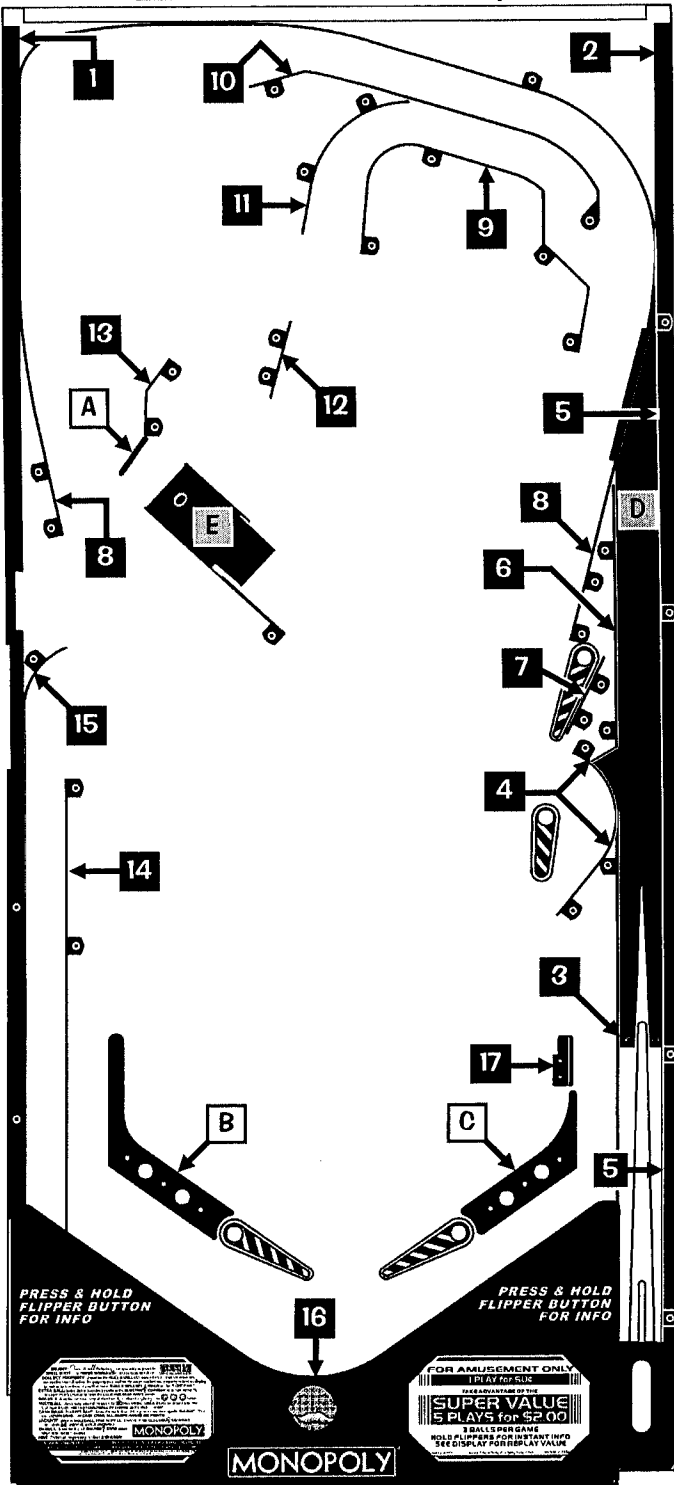

Sec. 4: Parts Id. ...



Playfield - Metal Posts (Screws) and Nuts (Actual Size) †

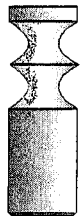

Item 1 Post can use 3/16" I.D. Rubber Ring, 545-5348-01; or if Item 1 Post is used in pairs, can use 3/4" - 3" Rubber Rings.

Items 2 & 4 Posts can use 7/16" O.D. Rubber Ring, 545-5348-17.

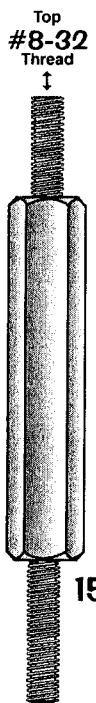
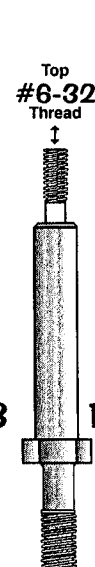
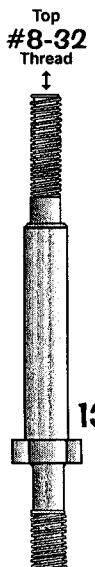
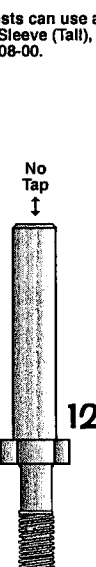
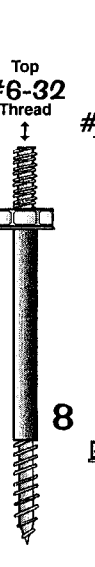
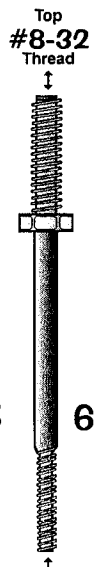
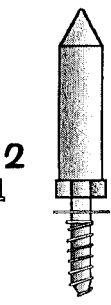
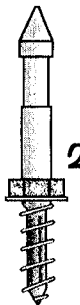

Item 16 is typically used to hold Hex Spacers onto the Playfield Top.

Item 17 is typically used to hold the bottom Cabinet Speaker (used with #6-32 Nylon Stop Nut, 240-5005-00).

Item 18 is typically used to hold Item 15 (515-5539-00) in Turbo Bumper Assy., 515-6459-04.

Note: The "Fins" keep the screw from turning inside the wood hole.

† Items with a Zero Qty. are not used in this game. Size and/or quantities may change during production.

Nut Note: All nuts shown with a "✓" are used in this game. The quantities (not specified) vary. The remaining Items listed are not used in this game and are noted for reference only (used in prior games).

Shown Below-	Shown Below-	Shown Below-	Shown Below-	Shown Below-
• #6-32 Nylon Stop Nut: 240-5005-00 ✓	• #6-32 KEPS Nut (with Star Washer): 240-5008-00 ✓	• #6-32 Hex Nut (No Star Washer): 240-5004-00 ✓	• #6-32 T-Nut: 240-5002-00 ✓	• #1/4" X 20 Flange Nut: 240-5300-00 ✓
Top & Side Views	Bottom & Side Views	Top View	Bottom & Side Views	Top & Side Views
Nylon Stop Nuts Not Shown:	KEPS Nuts Not Shown:	Hex Nuts Not Shown:	T-Nuts Not Shown:	Miscellaneous Nuts Not Shown:
<ul style="list-style-type: none"> • #6-32 (w/ 1/4" Hex Body): 240-5010-00 • #8-32: 240-5102-00 ✓ • #10-32: 240-5203-00 ✓ • #10-24: 240-5206-00 ✓ • #4-40: 240-5303-00 ✓ • #4-40 (18/8 Stainless): 240-5303-01 • 5/16"-18: 240-5316-00 	<ul style="list-style-type: none"> • #6-32 (w/ 1/4" Hex Body): 240-5011-00 • #8-32: 240-5104-00 • #10-32: 240-5208-00 ✓ • #10-24: 240-5207-00 ✓ • #4-40: 240-5318-00 	<ul style="list-style-type: none"> • #8-32: 240-5103-00 • #10-32: 240-5201-00 • #10-24: 240-5202-00 ✓ • #10-32 X 3/8": 240-5209-00 • 3/4-16: 240-5315-00 • #2-56: 240-5301-00 ✓ • 7/8"-14: 240-5317-00 	<ul style="list-style-type: none"> • #6-32 (w/Side Cut Off): 240-5002-01 • #8-32: 240-5101-00 ✓ • #10-32 (Black Oxide): 240-5007-00 • #10-32 (w/Side Cut Off): 240-5205-00 • #10-24: 240-5200-00 	<ul style="list-style-type: none"> • Plastic Pal Nut (on Flipper Buttons): 240-5003-00 • Metal Pal Nut (on Flipper Buttons): 240-5003-01 ✓ • #6-32 Wing Nut: 240-5001-00 • #8-32 Wing Nut: 240-5100-00 • 1/4"-20 Wing Nut: 240-5302-00 • 1/4"-20 Toggle Wing: 240-5324-00

Nº	METAL POST NAME	QTY.	SPI PART Nº	Nº	METAL POST NAME	QTY.	SPI PART Nº
1	Stand-Off Double Groove Post 1 1/16"	0	530-5102-01	10	Post #6-32 Tap / #6-32 Bottom	0	530-5127-00
2	Mini-Post Wood Screw	0	530-5004-00	11	Post Hex Base #6-32 Tap/#10-32 Bot.	1	530-5332-01
3	Mini-Post Wood Screw (no cut-away)	1	530-5004-01	12	Post Hex Base (No Tap)/#10-32 Bot.	2	530-5332-00
4	Mini-Post Mach. Screw / #10-32 Bot.	10	530-5005-00	13	Post Hex Base #8-32 Top/#10-32 Bot.	0	530-5332-02
5	Post Fasten #6-32 Top / #8-32 Bot.	0	530-5007-00	14	Post Hex Base #6-32 Top/#10-32 Bot.	3	530-5332-03
6	Post Fasten #8-32 Top / #6-32 Bot.	2	530-5008-00	15	Playfield Support #8-32 Top/Bottom	2	530-5285-00
7	Post Fasten #6-32 Top / #6-32 Bot.	16	530-5012-02	16	#6-32 X 3/4" Fin Shank Screw	0	237-5921-02
8	Post Fstn. #6-32 Top / Wood Scr. Bot.	0	530-5010-02	17	#6-32 X 1 1/4" Fin Shank Screw	4	237-5883-00
9	Post #6-32 Top / Wood Screw Bottom	0	530-5263-01	18	#6-32 X 1 3/16" Spirol Fin Shank Screw	18	237-5957-00



Sec. 4: Parts Id. ...

Playfield - Metal Spacers (Actual Size) †

A Standard USA 9 Inch Ruler is provided on the back cover.

Hex Spacers:

#6-32

Tap

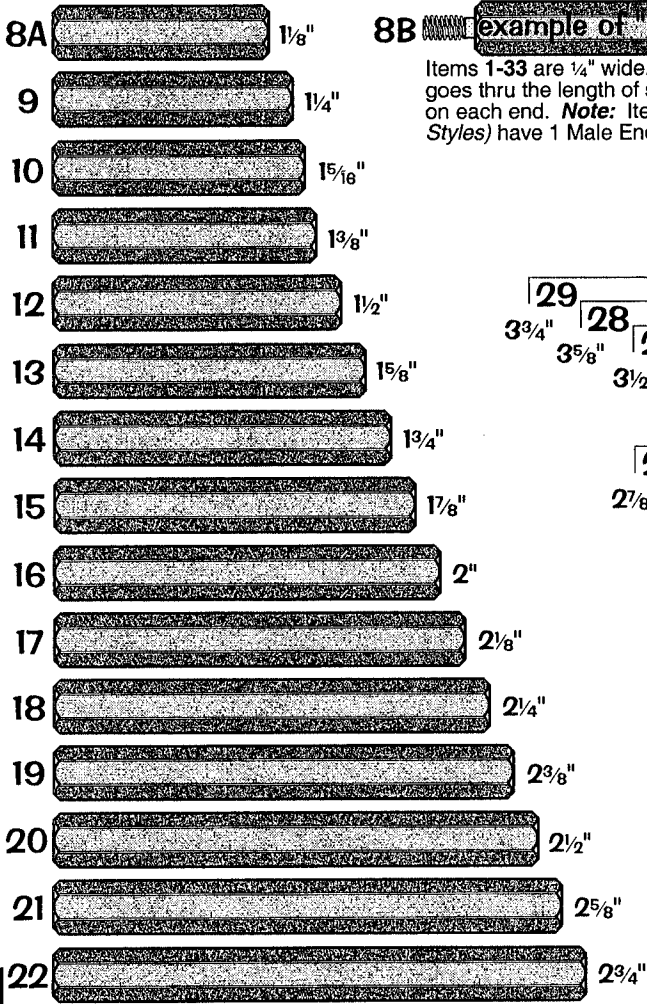

8B **example of "Bs"** 1 1/8" **Take Note:**

Items 1-33 are 1/4" wide. Items 35-46 are 5/16" wide. With Items 1-3A, 4A, 5 & 6A (the tap goes thru the length of spacer. With Items 7, 8A, 9-33 & 41-46, the tap is up to 5/8" deep on each end. **Note:** Items 3B, 4B, 6B (Not Shown) & 8B (Shown as example of all "B" Styles) have 1 Male End #6-32 Thread, the other end is Female, identical to Items 7-33.



‡ Hex Spacers Not Used in current games may no longer be available. Choose one size up or down (+/-) and compensate with washers.

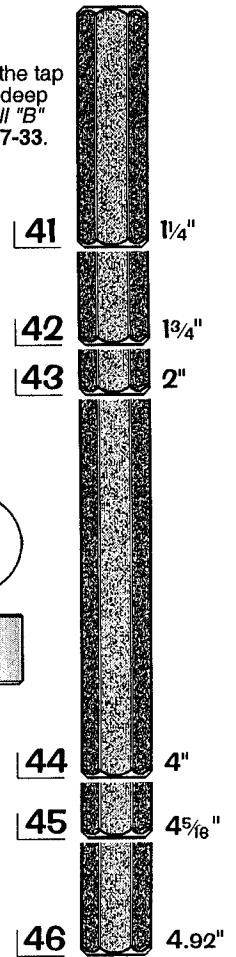
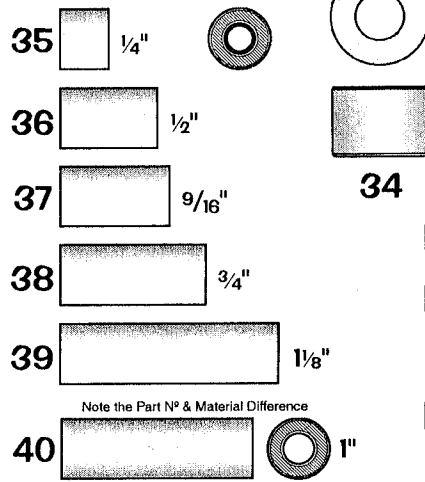

Sec. 4: Parts Id. ...

Nº	METAL SPACER NAME	QTY.	SPI PART Nº	Nº	METAL SPACER NAME	QTY.	SPI PART Nº
1	1/4" X 1/4" Hex Spacer #6-32 Tap	0	254-5008-00	22	2 3/4" X 1/4" Hex Spacer #6-32 Tap	0	254-5008-15
2	3/8" X 1/4" Hex Spacer #6-32 Tap	0	254-5008-12	23	2 7/8" X 1/4" Hex Spacer #6-32 Tap	0	254-5008-31
3A	1/2" X 1/4" Hex Spacer #6-32 Tap	5	254-5008-03	24	3" X 1/4" Hex Spacer #6-32 Tap	0	254-5008-14
3B	Same as 3A but with Male End #6-32	0	254-5024-03	25	3 1/8" X 1/4" Hex Spacer #6-32 Tap	0	254-5008-19
4A	5/8" X 1/4" Hex Spacer #6-32 Tap	0	254-5008-02	26	3 1/4" X 1/4" Hex Spacer #6-32 Tap	0	254-5008-26
4B*	Same as 4A but with Male End #6-32	0	254-5024-02	27	3 1/2" X 1/4" Hex Spacer #6-32 Tap	0	254-5008-27
5	3/4" X 1/4" Hex Spacer #6-32 Tap	1	254-5008-04	28	3 5/8" X 1/4" Hex Spacer #6-32 Tap	0	254-5008-25
6A	7/8" X 1/4" Hex Spacer #6-32 Tap	0	254-5008-05	29	3 3/4" X 1/4" Hex Spacer #6-32 Tap	0	254-5008-36
6B*	Same as 6A but with Male End #6-32	0	254-5024-05	30	4" X 1/4" Hex Spacer #6-32 Tap	0	254-5008-21
7	1" X 1/4" Hex Spacer #6-32 Tap	0	254-5008-06	31	4 1/4" X 1/4" Hex Spacer #6-32 Tap	0	254-5008-30
8A	1 1/8" X 1/4" Hex Spacer #6-32 Tap	0	254-5008-17	32	4 3/8" X 1/4" Hex Spacer #6-32 Tap	0	254-5008-29
8B	Same as 8A but with Male End #6-32	0	254-5024-17	33*	5 1/4" X 1/4" Hex Spacer #6-32 Tap	0	254-5008-35
9	1 1/4" X 1/4" Hex Spacer #6-32 Tap	0	254-5008-11	34	3/8" X 1/2" Spacer (Used with Backbox)	2	530-5099-00
10	1 5/8" X 1/4" Hex Spacer #6-32 Tap	0	254-5008-34	35	1/4" X 5/16" X .144" I.D. Spacer Tap	0	254-5014-03
11 ‡	1 3/8" X 1/4" Hex Spacer #6-32 Tap	0	254-5008-33	36	1/2" X 5/16" X .144" I.D. Spacer Tap	3	254-5014-00
12	1 1/2" X 1/4" Hex Spacer #6-32 Tap	0	254-5008-09	37	9/16" X 5/16" X .144" I.D. Spacer Tap	0	254-5014-04
13 ‡	1 5/8" X 1/4" Hex Spacer #6-32 Tap	0	254-5008-13	38	3/4" X 5/16" X .144" I.D. Spacer Tap	0	254-5014-01
14	1 3/4" X 1/4" Hex Spacer #6-32 Tap	0	254-5008-10	39	1 1/8" X 5/16" X .144" I.D. Spacer Tap	0	254-5014-02
15 ‡	1 7/8" X 1/4" Hex Spacer #6-32 Tap	0	254-5008-20	40	1" X 5/16" X .144" I.D. Spacer Tap	0	254-5001-00
16 ‡	2" X 1/4" Hex Spacer #6-32 Tap	2	254-5008-07	41	1 1/4" X 5/16" Hex Spacer #6-32 Tap	0	254-5018-09
17	2 1/8" X 1/4" Hex Spacer #6-32 Tap	2	254-5008-32	42	1 3/4" X 5/16" Hex Spacer #6-32 Tap	0	254-5018-06
18	2 1/4" X 1/4" Hex Spacer #6-32 Tap	0	254-5008-18	43	2" X 5/16" Hex Spacer #6-32 Tap	0	254-5018-07
19	2 3/8" X 1/4" Hex Spacer #6-32 Tap	0	254-5008-28	44	4" X 5/16" Hex Spacer #6-32 Tap	0	254-5018-03
20	2 1/2" X 1/4" Hex Spacer #6-32 Tap	0	254-5008-16	45	4 5/8" X 5/16" Hex Spacer #6-32 Tap	0	254-5018-00
21	2 5/8" X 1/4" Hex Spacer #6-32 Tap	2	254-5008-08	46	4.92" X 5/16" Hex Spacer #6-32 Tap	0	254-5018-04

THIS GAME ONLY:

Like Item 1 above, but with #8-32 Tap (Qty. 1) (254-5031-01) used on Bank Assy. (Item 10, Page 79).

Similar to Item 16 above, but 1.9" & Male End #8-32 (Qty. 1) (254-5031-03) see Left Ramp (Page 83).

Like Item 16 above, but with Male End #8-32 (Qty. 1) (254-5031-04) see Rt. Ramp (Page 85).



† Items with a Zero Qty. are not used in this game. Size and/or quantities may change during production.

Playfield - Plastic Posts and Spacers (Actual Size) †

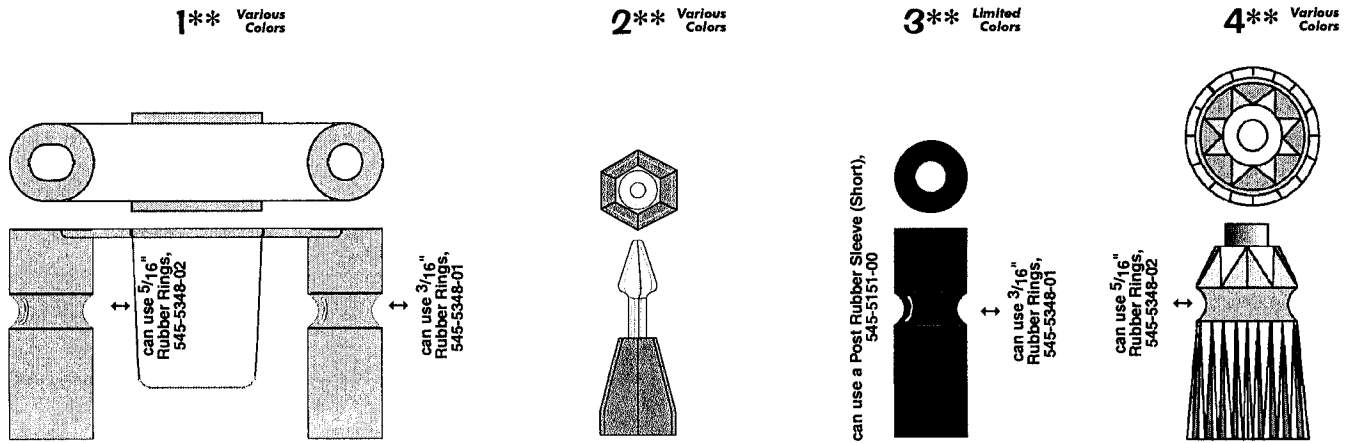

Items 3-4 Posts used in pairs can use 3/4" through 3" Rubber Rings, (See Rubber Parts for Part N^os).

Take Note:

PLASTIC PART COLOR CHART					
N ^o	Color	N ^o	Color	N ^o	Color
-00	Black	-06	Yellow	-12	Fluor. Blue
-01	Clear	-07	Orange	-13	Teal Green
-02	Red	-08	White	-14	Gray
-03	Amber	-09	Purple	-15	Luminescent
-04	Green	-10	Fluor. Orange	-16	Gold
-05	Blue	-11	Fluor. Green		

** Items 1, 2 & 4 come in various colors (may not be available in every color). Item 3 is currently only available in the color stated in this game manual (other colors used in prior games may no longer be available). The "-XX" in Part N^os which may come in various colors should be replaced with the desired 2-Digit N^o. corresponding to the color desired. Some colors may no longer be available for desired item.

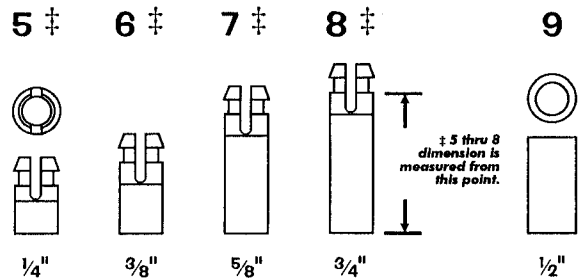

‡ Items 5 through 8 (Board Spacers) dimensions are measured from bottom to just under cut-away (see pictorial with Item 8 above).

- 10 11 12 13 14 15 16 17 18 19 20 21

Take Note:

If any one of Items 10-21 Spacers is not available in the size required, order the smaller sized spacers required to stack sizes together until appropriate size is achieved (e.g. If 1 1/8" is needed but unavailable, order a 1/2" + 5/8" & stack to = 1 1/8").

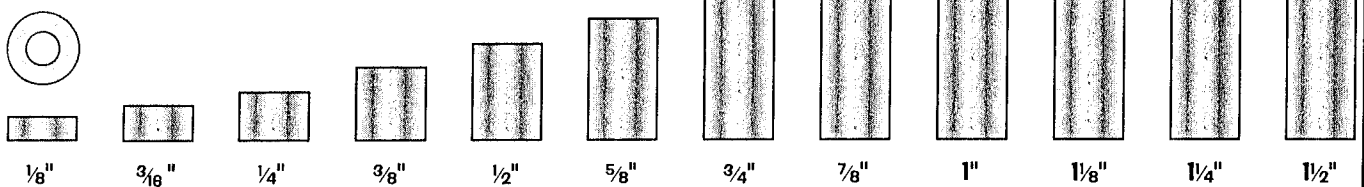

† Items with a Zero Qty. are not used in this game. Size and/or quantities may change during production.

N ^o	PLASTIC POST/SPACER NAME	QTY.	SPI PART N ^o	N ^o	PLASTIC POST/SPACER NAME	QTY.	SPI PART N ^o
1**	Top Lane Mini-Light Hood (Red)	4	550-5061-02	10	1/8" X 3/8" Spacer Gray	0	254-5000-19
Item 1 typically secured by: #6-32 X 1-3/4" PPH MS (Zinc) (Qty. 2/per) (237-5511-00) and Washer 9/64" X 5/16" OD X 1/32" (Qty. 2/per) (242-5017-00)				11	3/16" X 3/8" Spacer Gray (4 for Dot Display)	4	254-5000-18
2**	Mini-Jewel Post Clear	0	550-5052-01	12	1/4" X 3/8" Spacer Gray	0	254-5000-02
Item 2 typically secured by: #6 X 3/8" HWH AB (Zinc) (Qty. 1/per) (234-5000-00)				13	3/8" X 3/8" Spacer Gray	3	254-5000-12
3**	1 1/16" Single Groove Post (Clear)	19	550-5059-01	14	1/2" X 3/8" Spacer Gray	0	254-5000-01
4**	Single Groove Jewel Post (Clear)	12	550-5034-01	15	5/8" X 3/8" Spacer Gray	12	254-5000-14
Items 3 & 4 typically secured by: Post Fastening Screw #6-32 Top / #6-32 Bottom (Qty. 1/per) (530-5012-02, Item 7 Page 59)				16	3/4" X 3/8" Spacer Gray	0	254-5000-07
5 ‡	1/4" Sif. Rtn. Spacer White	0	254-5007-02	17	7/8" X 3/8" Spacer Gray	0	254-5000-11
6 ‡	3/8" Sif. Rtn. Spacer White	10	254-5007-01	18	1" X 3/8" Spacer Gray/Black	0	254-5000-04
7 ‡	5/8" Sif. Rtn. Spacer White	0	254-5007-00	19	1 1/8" X 3/8" Spacer Gray	0	254-5000-06
8 ‡	3/4" Sif. Rtn. Spacer White	0	254-5007-03	20	1 1/4" X 3/8" Spacer Gray	0	254-5000-05
9 ‡	1/2" X 1/4" Spacer White (Narrow)	0	254-5000-03	21	1 1/2" X 3/8" Spacer Gray	1	254-5000-08

THIS GAME ONLY:
Like Item 8 above, but 1/2" & fits a #8 screw (Qty. 4) (254-5032-04).
Used on 4-Position OPTO (Trans.) Board (Item AP-5, Page 79).

Section 4, Chapter 1: Parts Identification & Location



Sec. 4: Parts Id. ...

Playfield - Small Bayonet Type Bulbs and Sockets (Actual Size) †

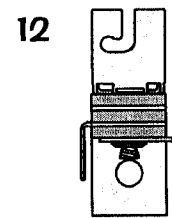
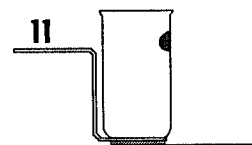
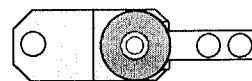
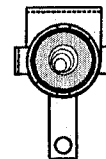
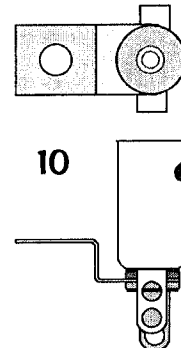
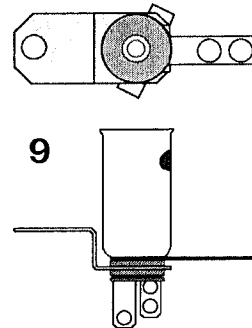
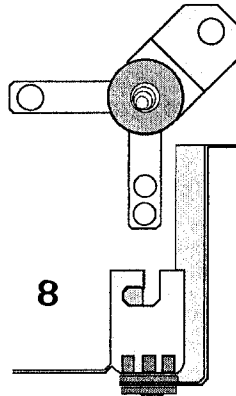
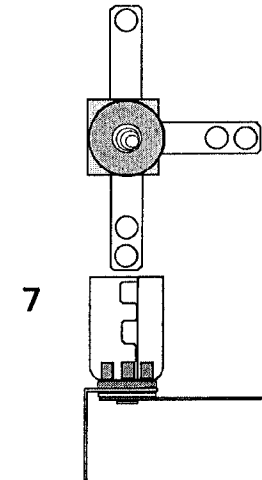
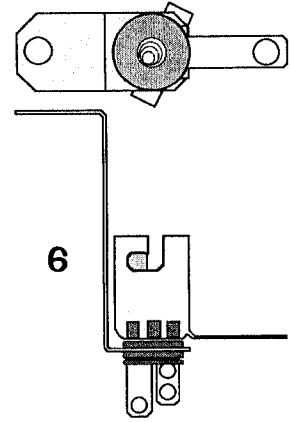
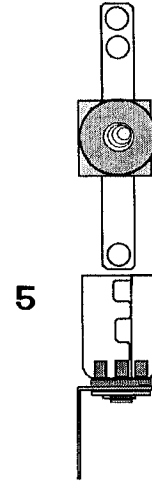
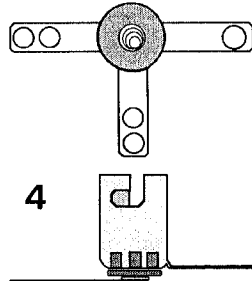
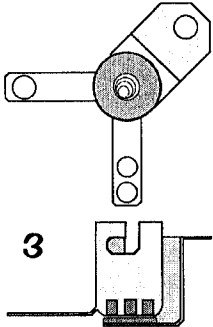
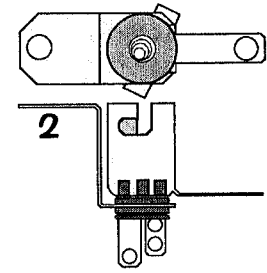
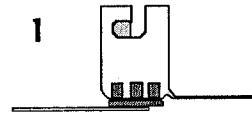
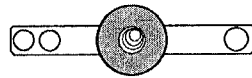
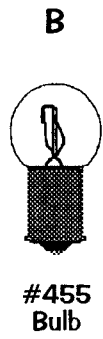
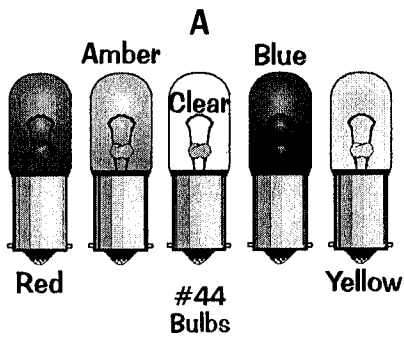

Sec. 4: Parts Id. ...

Nº	SMALL BULB & SOCKET NAME	QTY.	SPI PART Nº
A	#44 Bulb (Clear)	22	165-5000-44
A	#44 Bulb (Red)	0	165-5053-02
A	#44 Bulb (Amber)	0	165-5053-03
A	#44 Bulb (Blue)	0	165-5053-05
A	#44 Bulb (Yellow)	10	165-5053-06
B	#455 Twinkle Bulb	0	165-5003-00
1	2-Lug Staple Down Socket	4	077-5000-00
2	3-Lug Stand-Up Short Socket	0	077-5008-00
3	2-Lug Stand-Up Short Socket	0	077-5002-00
4	3-Lug Staple Down Socket	0	077-5001-00
5	2-Lug Laydown Socket	0	077-5003-00
6	3-Lug Stand-Up Long Socket	0	077-5009-00
7	3-Lug Laydown Socket (3 Lugs Flat)	1	077-5006-00
8	2-Lug Stand-Up Long Socket	0	077-5005-00
9	3-Lug Stand-Up Long Shell Socket	10	077-5013-00
10	2-Lug Stand-Up Lg. Shell Socket (Gls)	17	077-5031-00

Nº	SMALL BULB & SOCKET NAME	QTY.	SPI PART Nº
11	1-Lug Stand-Up Long Shell Socket	0	077-5012-00
12	3-Lug Laydown Socket (2 Lugs Bent)	0	077-5032-00

† Items with a Zero Qty. are not used in this game. Size and/or quantities may change during production.



Playfield - Large Bayonet Type Bulb and Sockets (Actual Size)†

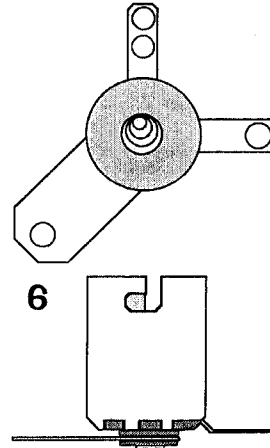
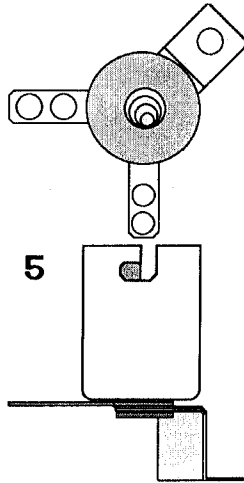
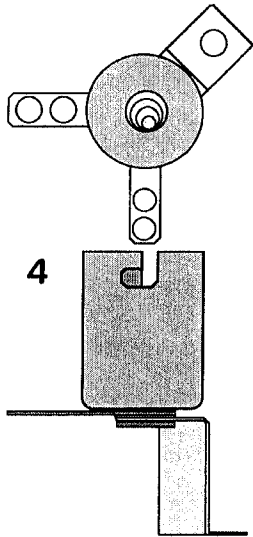
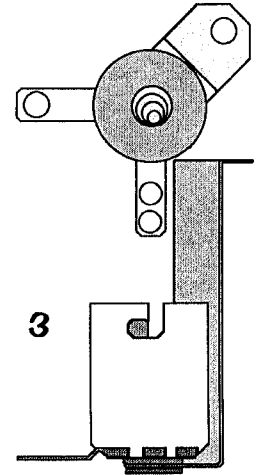
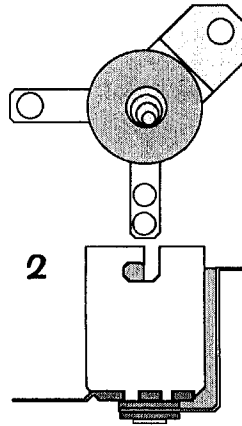
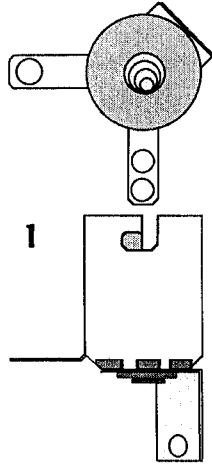
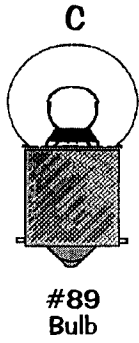

† Items with a Zero Qty. are not used in this game. Size and/or quantities may change during production.

Nº	LARGE BULB & SOCKET NAME	QTY.	SPI PART Nº	Nº	LARGE BULB & SOCKET NAME	QTY.	SPI PART Nº
C	#89 Bulb	3	165-5000-89	4	Stand-Up Socket Rev. Short	0	077-5103-00
1	Laydown Standard Socket	3	077-5100-00	5	2-Lug Stand-Up Small Socket	0	077-5106-00
2	2-Lug Stand-Up Short Socket	0	077-5101-00	6	Straight Leg Socket	0	077-5107-00
3	2-Lug Stand-Up Long Socket	0	077-5102-00				

Sec. 4: Parts Id. ...

Playfield - Wedge Base Bulbs and Sockets (Actual Size) †

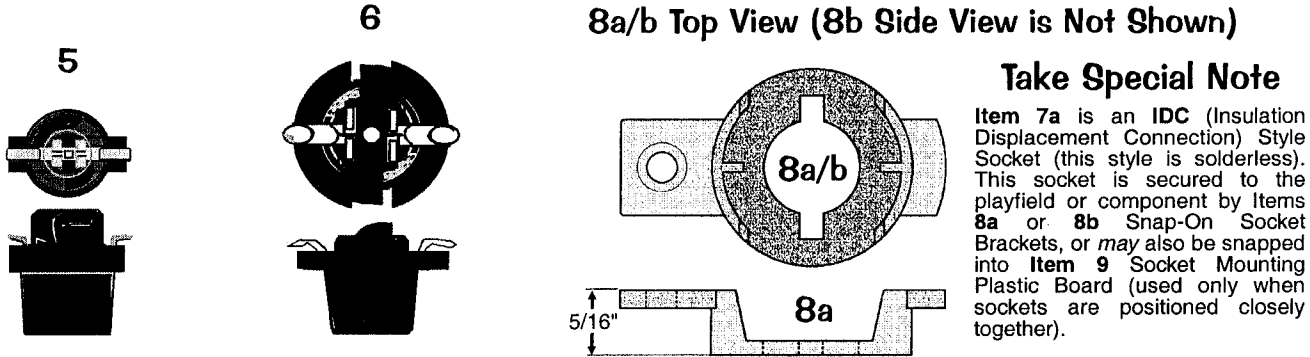
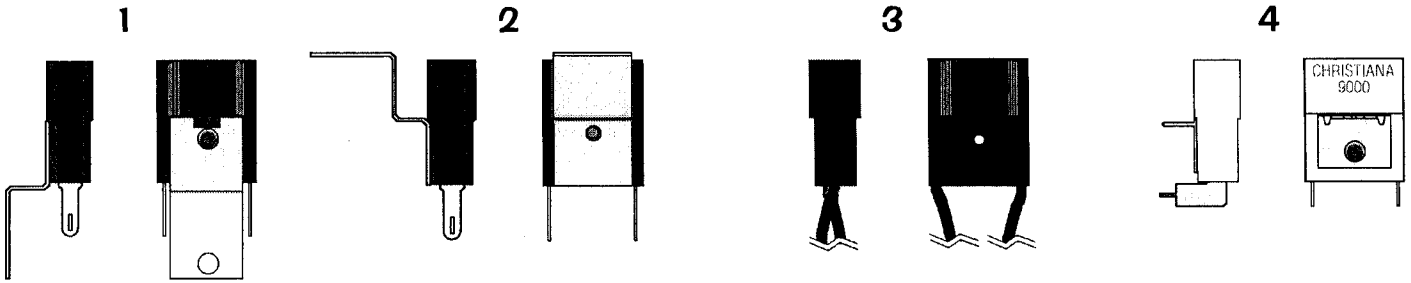
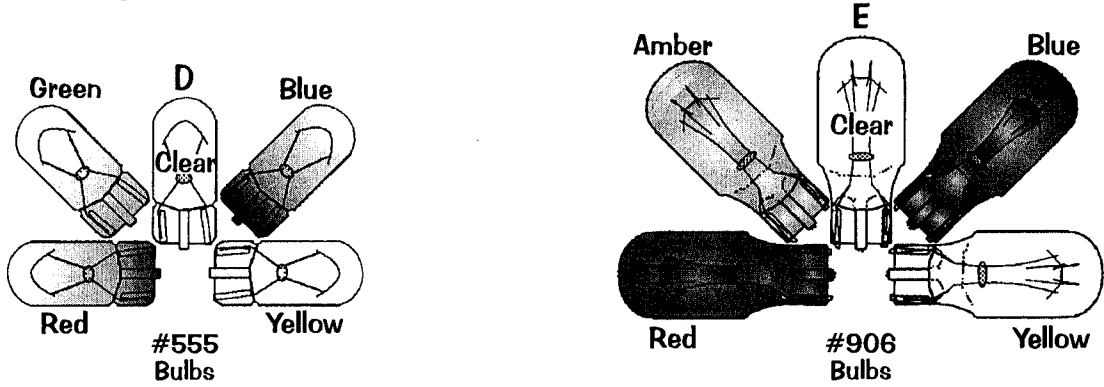

8a/b Top View (8b Side View is Not Shown)

Take Special Note

Item 7a is an IDC (Insulation Displacement Connection) Style Socket (this style is solderless). This socket is secured to the playfield or component by Items 8a or 8b Snap-On Socket Brackets, or may also be snapped into Item 9 Socket Mounting Plastic Board (used only when sockets are positioned closely together).

Just squeeze the "side arms" of the socket together and pull away from the bracket or mounting board for easy Bulb replacement.

Take Note:

* An asterisk (*) indicates item(s) are not noted in the pictorials.

- Item 3 Socket has 2 Wires attached are approximately 12" ea.
- Item 4 Socket **was** used on PC Light Boards to position bulbs horizontally; Item 4 Socket is secured by soldering into place.
- Item 5 Socket **was** used on PC Light Boards to position bulbs vertically; Item 5 Socket is secured by "twisting" into place.
- Item E Bulb (#906) is normally used in conjunction with Item 6 Socket, but **can** be used with Items 1, 2, 4 or 7a/b.
- Item 7a Socket is equipped with a *built-in* Diode, 1N4003 (112-5003-00), however, replacement can be made with a 1N4001 Diode (112-5001-00).
Item 7b Socket is **NOT** equipped with a diode (not required).

Note: Always replace with same type bulb in original application.

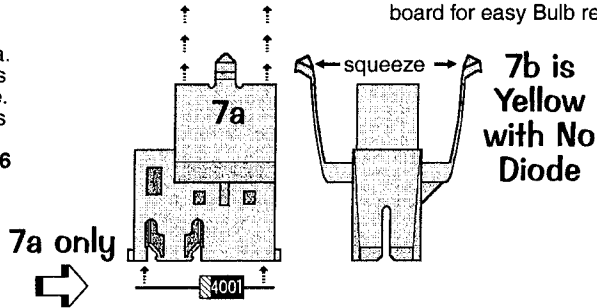

7b is Yellow with No Diode

Nº	WEDGE BULB & SOCKET NAME	QTY.	SPI PART Nº	Nº	WEDGE BULB & SOCKET NAME	QTY.	SPI PART Nº
D	#555 Wedge Base Bulb (Clear)	74	165-5002-00	1	#555 Wedge Base Socket (Laydown)	0	077-5026-01
D	#555 Wedge Base Bulb (Red)	2	165-5054-02	2	#555 Wedge Base Socket (Offset)	7	077-5029-00
D	#555 Wedge Base Bulb (Green)	0	165-5054-04	3	#555 W.B. Socket (for Pop Bumper)	6	077-5206-00
D	#555 Wedge Base Bulb (Blue)	1	165-5054-05	4	#555 W.B. Socket (Solder Type)	0	077-5207-00
D	#555 Wedge Base Bulb (Yellow)	4	165-5054-06	5	#555 Wedge Base Socket (Twist)	0	077-5007-00
E	#906 Wedge Base Bulb (Clear)	6	165-5004-00	6	#906 Wedge Base Socket (Twist)	0	077-5016-00
E	#906 Wedge Base Bulb (Red)	0	165-5004-02	7a	#555 IDC Snap-On Socket	68	077-5216-00
E	#906 Wedge Base Bulb (Amber)	0	165-5004-03	7b	#555 IDC Snap-On Socket No Diode	6	077-5216-01
E	#906 Wedge Base Bulb (Blue)	0	165-5004-05	8a	5/16" Ht. Snap-On Socket Bracket	36	545-5760-18
E	#906 Wedge Base Bulb (Yellow)	0	165-5004-06	8b*	19/32" Ht. Snap-On Socket Bracket	0	545-5760-19
				9a*	Clear Plastic Socket Mtg. Bd. (32/per)	1	830-5987-01
				9b*	Clear Plastic Socket Mtg. Bd. (1/per)	6	830-5987-04

† Items with a Zero Qty. are not used in this game. Size and/or quantities may change during production.

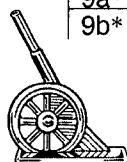

Drawings for Major Assemblies & Ramps (The Blue Pages)

Overview

Drawings are provided for the Major Assemblies in this game with individual parts of each assembly numbered. Items noted with a white circle ○ are mounted above the playfield; items noted with a black circle ● are mounted below. All numbered parts describe the NAME, QUANTITY & PART N°. ASSOCIATED PARTS (AP-) are noted and/or viewed with the associated Major Assembly. **Important:** Read all "Take Note:" items.

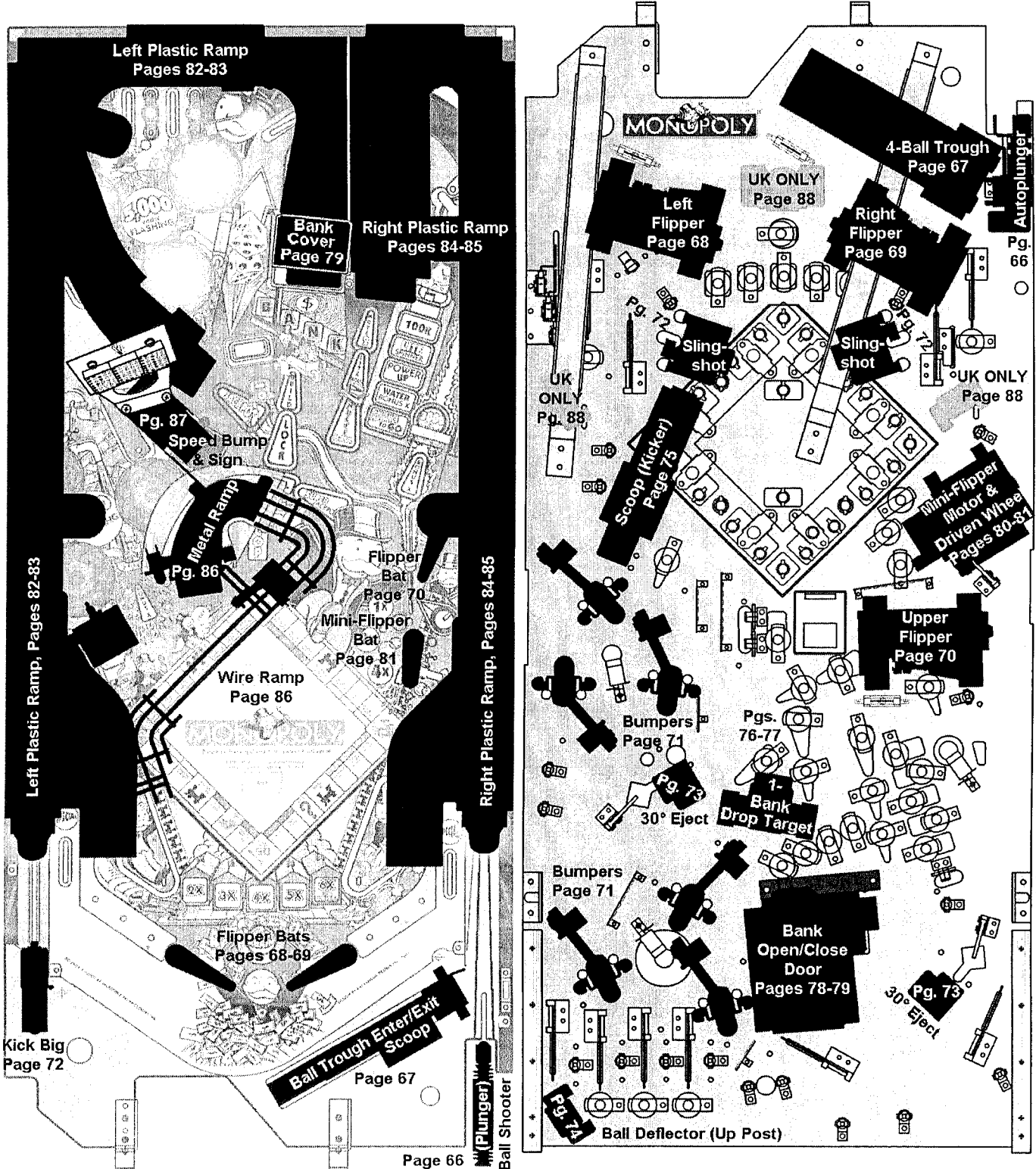

Sec. 4: Drawings ...



Ball Shooter (Plunger) Assembly, 500-6146-00-04 (Items 1-8)

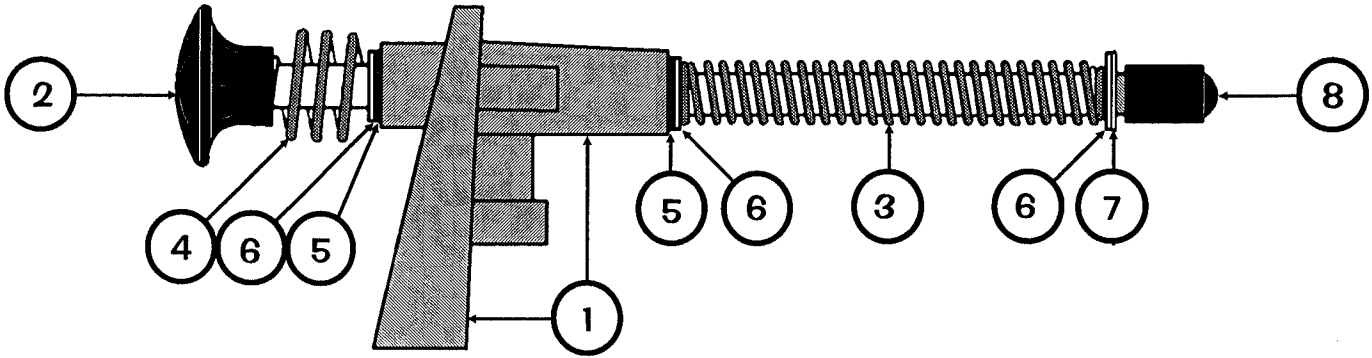

Nº	INDIVIDUAL PART NAME	QTY.	SPI PART Nº	Nº	INDIVIDUAL PART NAME	QTY.	SPI PART Nº
1	Housing (Shooter Assembly)	1	535-5067-02	4	Compression Spring (Short Plunger)	1	266-5010-00
Item 1 is secured to the Cabinet by: Support Plate (Qty. 1) (535-5027-00), #10-32 X 1/2" PPH (Sems) Zinc TF (Qty. 3) (237-6033-00), #10 Split Lock Washer (Qty. 3) (234-5003-00) and #6 X 5/8" HWH AB (Zinc) (Qty. 2) (234-5002-00)				5	Bushing, 3/8" I.D. (Oilite)	2	280-5010-00
2	Rod Assembly (w/Black Knob)	1	515-6557-00	6	Washer, 3/8" I.D. X 5/8" O.D. X 1/16"	3	242-5014-00
3	Comp. (Return) Spring (GRN, .035" ø)	1	266-5001-04	7	Retaining Ring, 3/8" ø Shaft	1	270-5012-00
				8	Plunger Tip (Black 50 Duro)	1	545-5276-00

Autoplunger Coil Assembly, 500-6092-05 (Items 1-6) with Autoplunger Arm Weld Assembly, 500-6091-00 (Items 7-9)

Nº	'PLUNGER COIL PART NAME	QTY.	SPI PART Nº
1	Autoplunger Coil Bracket Assembly	1	515-6527-00
Item 1 is secured below the playfield by: #8 X 1/2" HWH AB (Zinc) (Qty. 9) (234-5101-00)			
2	Coil Retainer Bracket	1	535-5203-03
Item 2 is secured to Item 1 by: #8-32 X 1/4" PPH MS (Sems) Zinc (Qty. 2) (232-5300-00)			
3	Coil, 23-700	1	090-5022-00T
ORDERING ABOVE (ITEM 3) COIL PART Nº WILL INCLUDE:			
—	Diode, 1N4004 (positioned at top)	1	112-5003-00
4	Coil Sleeve	1	545-5031-00
5	Plunger & Link Assembly	1	515-5338-00
ORDERING ABOVE (ITEM 5) SUB-ASSY. PART Nº WILL INCLUDE:			
5A	Plunger 2"	1	530-5025-01
5B	Plunger Link	1	545-5293-00
5C	Roll Pin, 1/8" ø X 5/8" Lg.	1	251-5008-00
Item 5B is secured to Item 7 by: Retaining Ring, 1/4" ø Shaft (Qty. 1) (270-5002-00)			
Ordering Note: If 515-5338-00 is unavailable, order the individual part(s) actually required.			
6	Compression (Return) Spring	1	266-5020-00

Nº	... ARM WELD PART NAME	QTY.	SPI PART Nº
7	Arm Weld Assembly	1	515-6526-00
Item 7 is secured to Item 8 by: Retaining Ring, 1/4" ø Shaft (Qty. 1) (270-5002-00)			
8	Autoplunger Fulcrum	1	535-7697-00
9	Nyliner, 1/4" (Thomson #411-FF)	2	545-5423-00

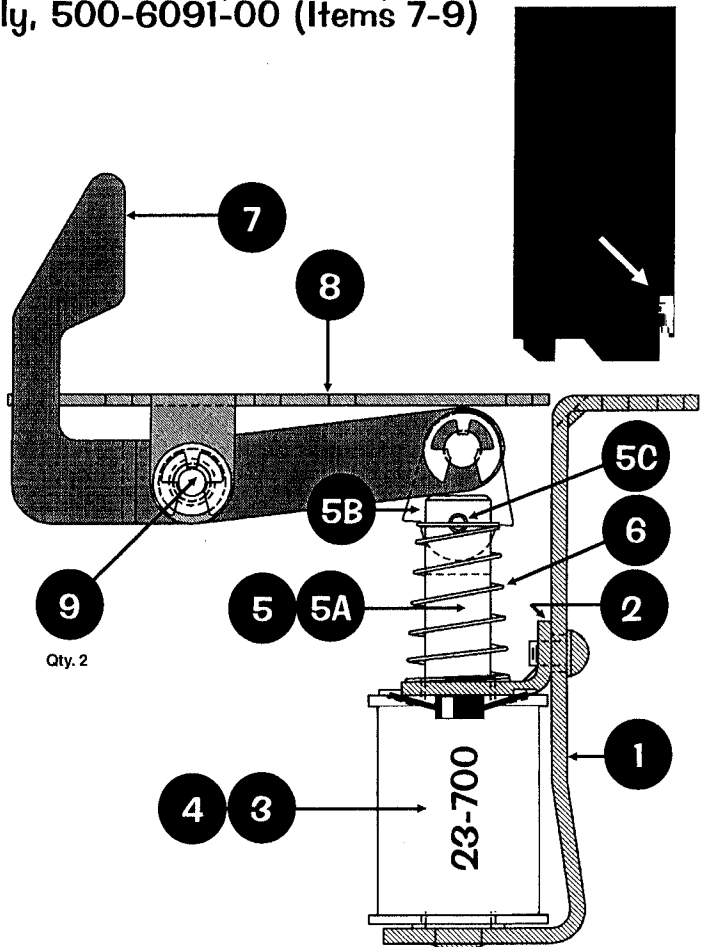

Sec. 4: Drawings ...



4-Ball Trough Assembly, 500-6318-14 (Items 1-13)

and Associated Parts: See Parts Table below.

Ordering Note: Identical to 500-6318-24 except does not require Item 11, Trough Ball Guide Plate (used only when magnets are present in the game).

Take Special Note:

Item AP-A, Enter / Exit Scoop, 535-7329-01 (not included with the 4-Ball Trough Assy.), is shown how it is actually positioned over the 4-Ball Trough Assembly. It is mounted above the playfield.

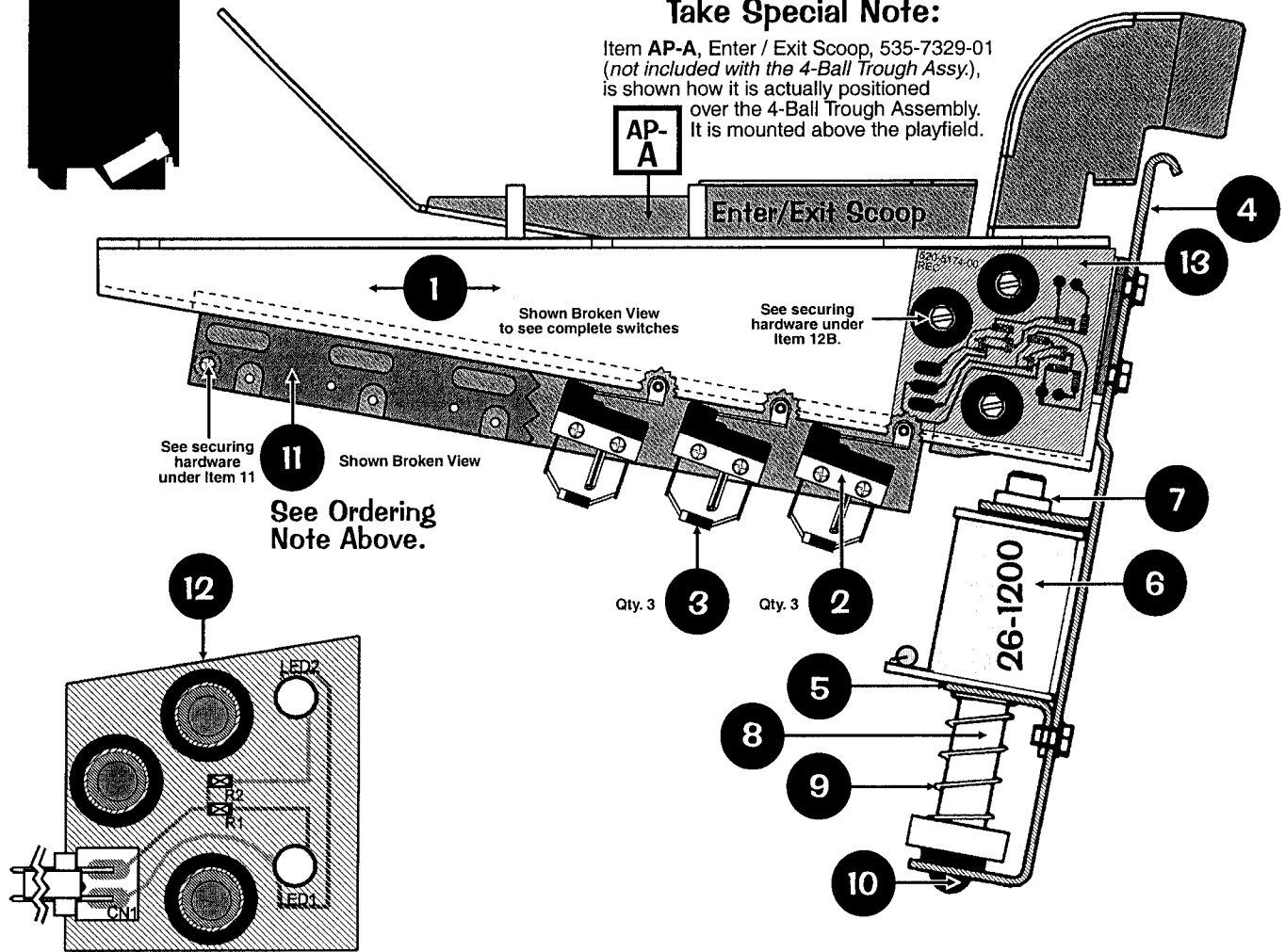

See securing hardware under Item 11

See Ordering Note Above.

Item 12, Dual OPTO TRANS (Transmitter) Board, 520-5173-00, is mounted on the other side of the Trough Assembly, in line with Item 13, Dual OPTO REC (Receiver) Board, 520-5174-00, using same hardware.

Take Note:

* An asterisk (*) indicates item(s) are not noted in the pictorials.

For a break-down of parts of Items 12 & 13 OPTO Boards (520-5173-00 & 520-5174-00), see Section 5, Chapter 4, Trough Up-Kicker Dual OPTO Boards Theory of Operation & Schematic, Component Layout & Parts, Page 99.

Nº	INDIVIDUAL PART NAME	QTY.	SPI PART Nº	Nº	INDIVIDUAL PART NAME	QTY.	SPI PART Nº
1	Ball Trough Outhole Mounting Bracket	1	515-6580-01	10	Rubber Bumper (Grommet)	1	545-5105-00
Item 1 is secured below the playfield by: #8 X 1/2" HWH AB (Zinc) (Qty. 6) (234-5101-00)				11	Trough Ball Guide Plate	0	535-7801-00
2	Micro Switch (Roller Actuator, Lite-Force)	3	180-5119-02	Item 11 is secured to Item 1 by: 1/4" X 5/16" X .144" I.D. Spacer Tap, (Qty. 1) (254-5014-03) and #2-56 X 1/2" HWH (Ser) UNS #4HD TR3 BO (Qty. 4) (237-5937-02)			
Item 2 is secured to Item 1 by: #2-56 X 1/2" HWH (Sr) UNS #4HD TR3 BO (Qty. 6) (237-5937-02) Item 2 requires: Heat Shrink Tubing 1/8" ø PUI-24 (Qty. 1/per) (605-5006-00)				12	Dual OPTO TRANS Board Assembly	1	515-5173-00
3	Switch Diode, 1N4001	3	112-5001-00	13	Dual OPTO REC Board Assembly	1	515-5174-00
4	Coil Mounting Bracket	1	535-7330-01	Items 12 & 13 are by: #6-32 X 5/8" HWH Swage (Serr) Zinc (Qty. 3/per) (237-5976-04) For Individual Items use: Dual OPTO TRANS Bd. (Qty. 1) (520-5173-00), Dual OPTO REC Bd. (Qty. 1) (520-5174-00), OPTO PCB Tube Spacer (Brass) (Qty. 3/per) (530-5308-02) or OPTO PCB Rubber Grommet (Qty. 3/per) (545-5518-00)			
5	Coil Retaining Bracket	1	535-5203-03	ASSOCIATED PARTS ARE NOT INCLUDED WITH THE ABOVE ASSEMBLY.			
Item 5 is secured to Item 4 by: #8-32 X 1/4" HWH MS (Serr) Zinc (Qty. 2) (237-5964-01)				Nº	ASSOCIATED PART NAME	QTY.	SPI PART Nº
6	Coil, 26-1200	1	090-5044-00T	AP-A	Ball Trough Enter / Exit Scoop	1	535-7329-01
ORDERING ABOVE (ITEM 6) COIL PART Nº WILL INCLUDE:				Item AP-A secured to the playfield by: #8 X 1/2" HWH AB (Zinc) (Qty. 4) (234-5101-00).			
—	Diode, 1N4004 (positioned at top)	1	112-5003-00	AP-B*	Steel Balls (1-1/16" ø)	4	260-5000-00
7	Coil Sleeve (Short) (Formost #10-7077)	1	545-5076-01				
8	Plunger Assembly	1	515-5941-01				
9	Compression (Return) Spring	1	266-5020-00				

Flipper (Left) Assembly, 500-5944-12 (Items 1-12) and Associated Part: Yellow Flipper Bat & Shaft Assy., 515-5133-06-06 (Item AP-A)

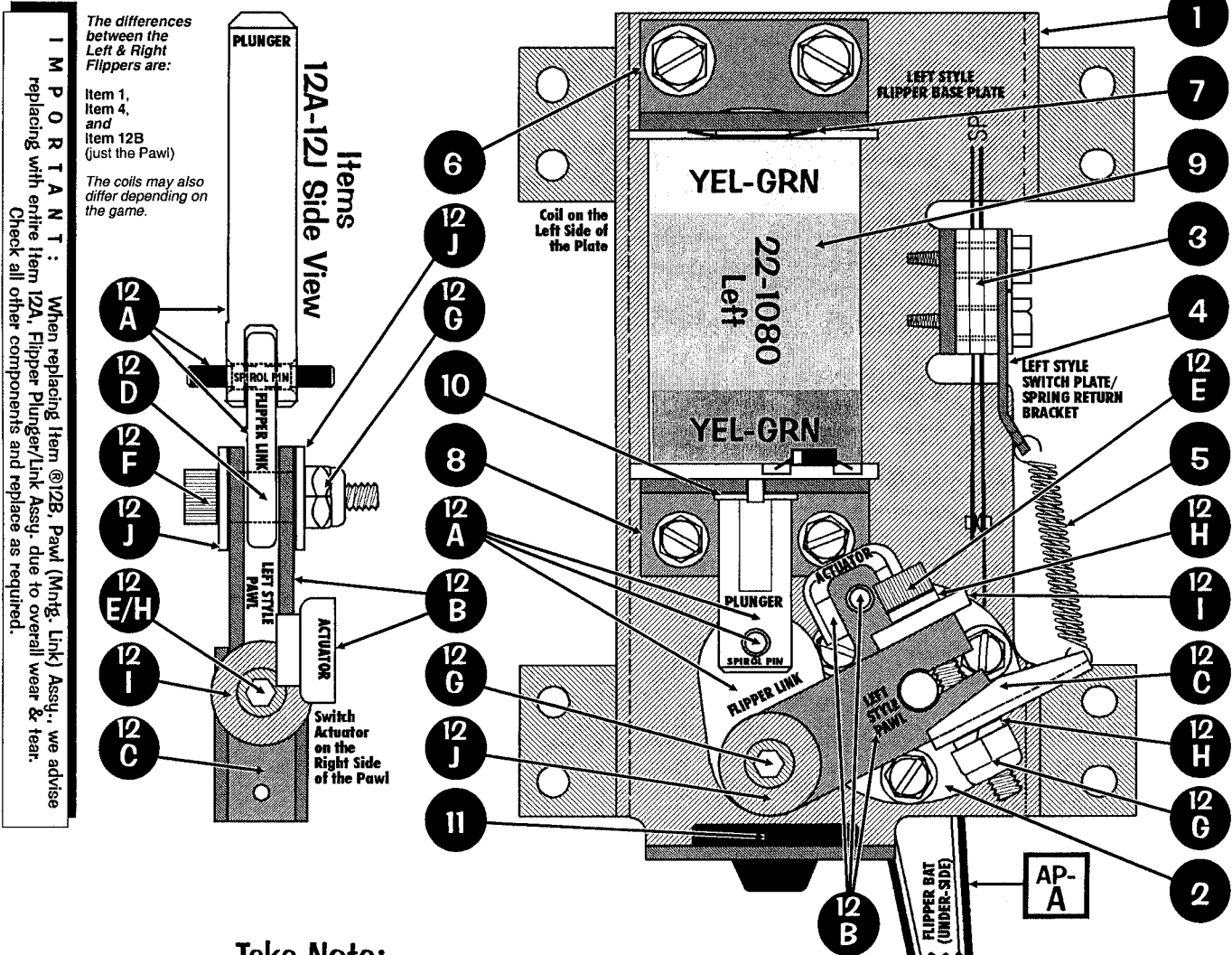

IMPORTANT: When replacing Item 12B, Pawl (Mntg. Link) Assy., we advise replacing with entire Item 12A, Flipper Plunger/Link Assy., due to overall wear & tear. Check all other components and replace as required.

The differences between the Left & Right Flippers are:
Item 1, Item 4, and Item 12B (just the Pawl)
The coils may also differ depending on the game.

Take Note:

@ "R" indicates Item noted is secured with rivet(s) as listed.

Nº	INDIVIDUAL PART NAME	QTY.	SPI PART Nº	Nº	INDIVIDUAL PART NAME	QTY.	SPI PART Nº
1	Flipper Base Plate Kit (Left)	1	515-6617-01	12	Plunger, Link & Pawl (Left) Sub-Assy.	1	515-6518-01
ORDERING ABOVE (ITEM 1) KIT (LEFT) PART Nº WILL INCLUDE:				ORDERING ABOVE (ITEM 12) SUB-ASSY. PART Nº WILL INCLUDE:			
Note: Flipper Base Plate (Left) comes threaded with all securing hardware (Thread Forming Screws) as listed under each of the Items which will get secured to it (Items 2, 3, 6 & 8).				12A Flipper Plunger/Link Sub-Assy. 1 515-6304-01			
Item 1 is secured below the playfield by: #10 X 1/2" HWH MS (Ser.) Zinc ST (Qty. 8) (237-5949-00)				includes: Plunger "Flipper" Link 1 545-5611-00			
2	Flipper Bat Bushing	1	545-5594-00	includes: Spirol Pin ø 5/32" X 3/4" Lg. 1 251-5015-02			
Item 2 is secured to Item 1 by: #6-32 X 3/8" HWH Swage (Ser.) Zc. (Qty. 3) (237-5976-02)				includes: Flipper Plunger with "Flat" 1 530-5349-01			
3	Power (End of Stroke) Switch	1	180-5149-00	@12B Pawl (Mntg. Link) (Left) Sub-Assy. 1 515-6305-01			
Item 3 is secured to Item 1 by: #6-32 X 5/8" HWH Swage (Ser.) Zc. (Qty. 2) (237-5976-04)				includes: Pawl (Mounting Link) (Left) Plain 1 535-7271-01			
4	Switch Plate/Spring Return Lt. Brkt.	1	535-7354-01	includes: @ Switch Actuator 1 545-5612-00			
5	Flipper Return Spring	1	265-5035-00	includes: Rivet, 1/8" ø X 1/4" Lg. 1 249-5003-00			
6	Coil Stop Bracket Sub-Assembly	1	515-6308-01	12C	Return Bracket	1	535-7353-00
Item 6 is secured to Item 1 by: #10-32 X 3/8" SHWH Swage (Ser.) Zinc (Qty. 2) (237-5985-00) and #10 Split Lock Washer (Qty. 2) (244-5003-00)				12D	Flipper Link Bushing (Metal, Ext.)	1	530-5139-01
7	Spring Washer (17/32" ID X 3/4" X 1")	1	269-5002-00	includes: #10-32 X 1-1/4" Lg. Socket Head 1 237-5950-01			
8	Coil Support Bracket	1	535-7356-00	12F	#10-32 X 7/8" Lg. Socket Head	1	237-5966-00
Item 8 is secured to Item 1 by: #8-32 X 3/8" HWH Swage (Ser.) Zc. (Qty. 2) (237-5975-00)				12G	#10-32 Nylon Stop Nut	2	240-5203-00
9	Coil, 22-1080 (YEL-GRN) (Left)	1	090-5032-00T	12H	#10 Split Lock Washer	2	244-5003-00
ORDERING ABOVE (ITEM 9) COIL PART Nº WILL INCLUDE:				12I	Washer .203" ID X .63" OD X .105" Thk w/cut	1	242-5039-01
— Diode, 1N4004 (positioned at top) 1 112-5003-00				12J	Washer .203" ID X .63" OD X .062" Thk	2	242-5038-00
10	Coil Sleeve	1	545-5388-00	ASSOCIATED PARTS ARE NOT INCLUDED WITH THE ABOVE ASSEMBLY.			
11	Deflector Pad (Bumper)	1	545-5428-00	Nº	ASSOCIATED PART NAME	QTY.	SPI PART Nº
				AP-A	YELLOW Flipper Bat & Shaft (Plain)	1	515-5133-06-06
				(Non-Knurled End) Assembly			
				Large Flipper RED Rubber Ring 1 545-5277-22			

Sec. 4: Drawings ...



Flipper (Right) Assembly, 500-5944-02 (Items 1-12)
and Associated Part: Yellow Flipper Bat & Shaft Assy., 515-5133-06-06 (Item AP-A)

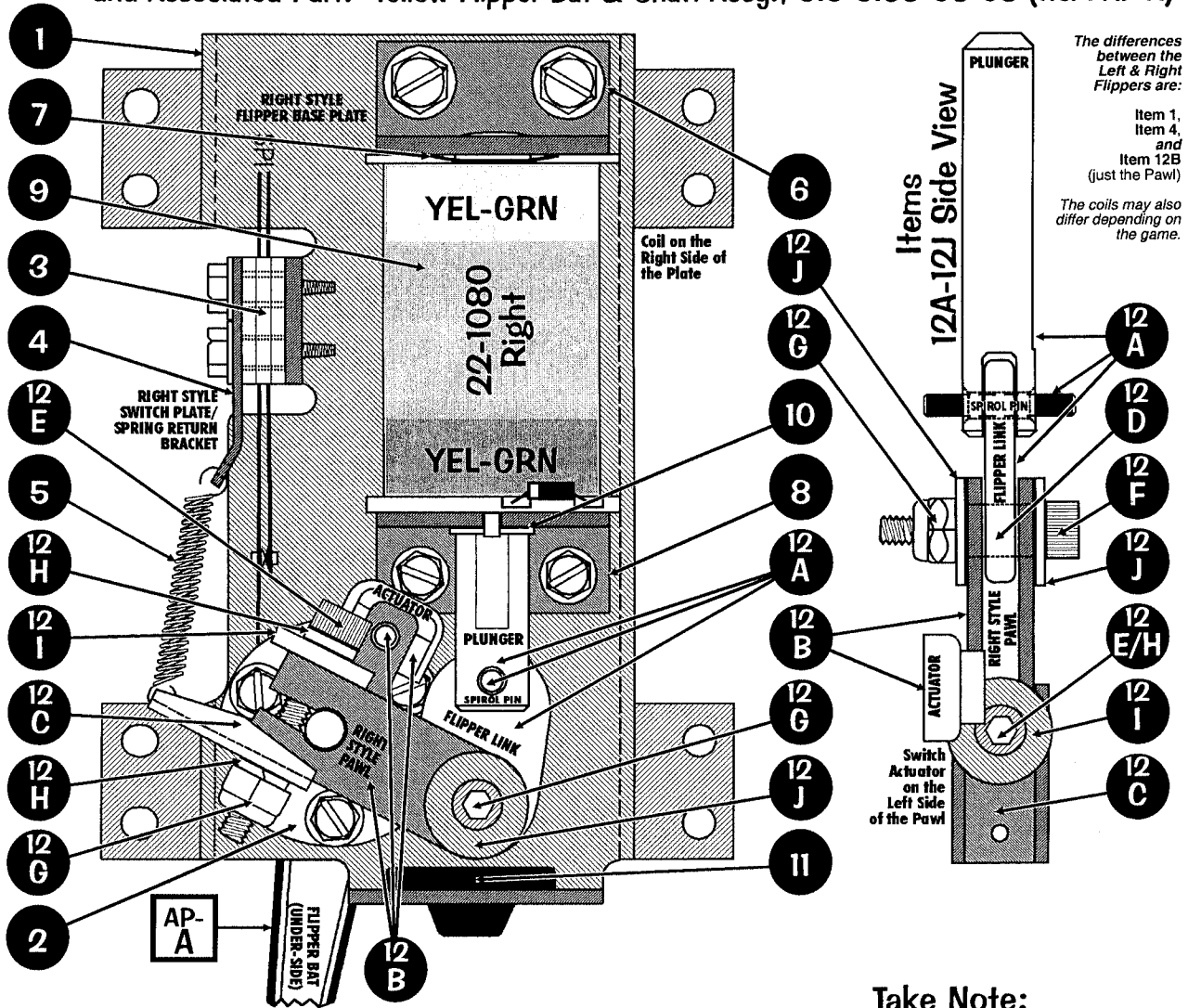

Take Note:

© "R" indicates Item noted is secured with rivet(s) as listed.

Nº	INDIVIDUAL PART NAME	QTY.	SPI PART Nº
1	Flipper Base Plate Kit (Right)	1	515-6617-00
ORDERING ABOVE (ITEM 1) KIT (RIGHT) PART Nº WILL INCLUDE:			
<i>Note:</i> Flipper Base Plate (Right) comes threaded with all securing hardware (Thread Forming Screws) as listed under each of the Items which will get secured to it (Items 2, 3, 6 & 8).			
Item 1 is secured below the playfield by: #10 X 1/2" HWH MS (Serr) Zinc ST (Qty. 8) (237-5949-00)			
2	Flipper Bat Bushing	1	545-5594-00
Item 2 is secured to Item 1 by: #6-32 X 3/8" HWH Swage (Ser.) Zc. (Qty. 3) (237-5976-02)			
3	Power (End of Stroke) Switch	1	180-5149-00
Item 3 is secured to Item 1 by: #6-32 X 5/8" HWH Swage (Ser.) Zc. (Qty. 2) (237-5976-04)			
4	Switch Plate/Spring Return Rt. Brkt.	1	535-7354-00
5	Flipper Return Spring	1	265-5035-00
6	Coil Stop Bracket Sub-Assembly	1	515-6308-01
Item 6 is secured to Item 1 by: #10-32 X 3/8" SHWH Swage (Serr) Zinc (Qty. 2) (237-5985-00) and #10 Split Lock Washer (Qty. 2) (244-5003-00)			
7	Spring Washer (17/32" ID X 3/4" X 1")	1	269-5002-00
8	Coil Support Bracket	1	535-7356-00
Item 8 is secured to Item 1 by: #6-32 X 3/8" HWH Swage (Ser.) Zc. (Qty. 2) (237-5975-00)			
9	Coil, 22-1080 (YEL-GRN) (Right)	1	090-5032-00T
ORDERING ABOVE (ITEM 9) COIL PART Nº WILL INCLUDE:			
—	Diode, 1N4004 (positioned at top)	1	112-5003-00
10	Coil Sleeve	1	545-5388-00
11	Deflector Pad (Bumper)	1	545-5428-00

Nº	INDIVIDUAL PART NAME	QTY.	SPI PART Nº
12	Plunger, Link & Pawl (Rt.) Sub-Assy.	1	515-6518-00
ORDERING ABOVE (ITEM 12) SUB-ASSY. PART Nº WILL INCLUDE:			
12A	Flipper Plunger/Link Sub-Assy.	1	515-6304-01
<i>includes:</i> Plunger "Flipper" Link 1 545-5611-00			
<i>includes:</i> Spirol Pin ϕ 5/32" X 3/4" Lg. 1 251-5015-02			
<i>includes:</i> Flipper Plunger with "Flat" 1 530-5349-01			
12B	Pawl (Mntg. Link) (Rt.) Sub-Assy.	1	515-6305-00
<i>includes:</i> Pawl (Mounting Link) (Rt.) Plain 1 535-7271-00			
<i>includes:</i> @ Switch Actuator 1 545-5612-00			
<i>includes:</i> Rivet, 1/8" ϕ X 1/4" Lg. 1 249-5003-00			
12C	Return Bracket	1	535-7353-00
12D	Flipper Link Bushing (Metal, Ext.) (.385" Lg. X .192" ID X .312" OD)	1	530-5139-01
12E	#10-32 X 1-1/4" Lg. Socket Head	1	237-5950-01
12F	#10-32 X 7/8" Lg. Socket Head	1	237-5966-00
12G	#10-32 Nylon Stop Nut	2	240-5203-00
12H	#10 Split Lock Washer	2	244-5003-00
12I	Washer .203" ID X .63" OD X .105" Thk w/Cut	1	242-5039-01
12J	Washer .203" ID X .63" OD X .062" Thk	2	242-5038-00

ASSOCIATED PARTS ARE NOT INCLUDED WITH THE ABOVE ASSEMBLY.

Nº	ASSOCIATED PART NAME	QTY.	SPI PART Nº
AP-A	YELLOW Flipper Bat & Shaft (Plain) (Non-Knurled End) Assembly	1	515-5133-06-06
	Large Flipper RED Rubber Ring	1	545-5277-22



Flipper (Upper) Assembly, 500-5944-35 (Items 1-12) and Associated Part: Yellow Flipper Bat & Shaft Assy., 515-5133-06-06 (Item AP-A)

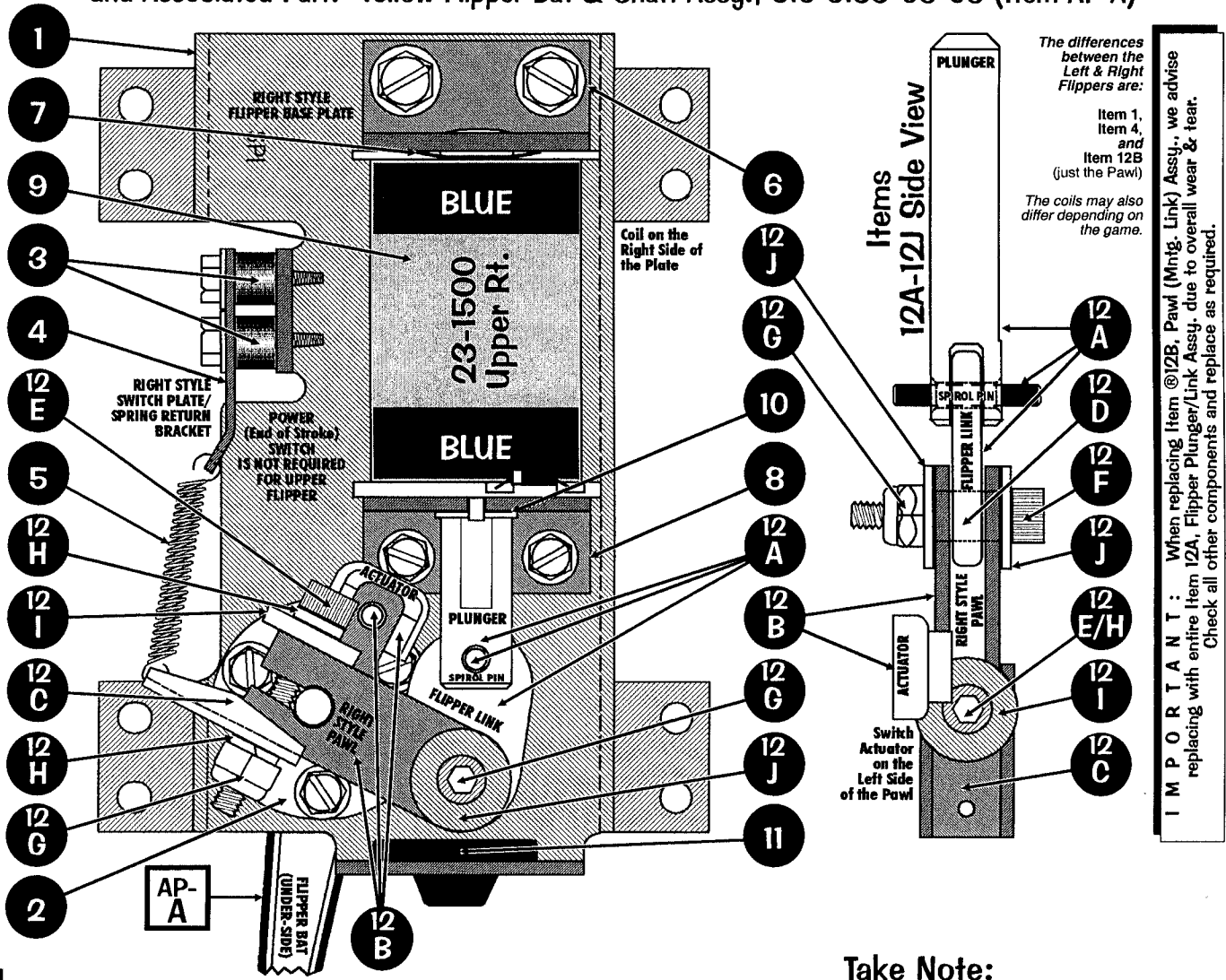

Take Note:

© "R" indicates Item noted is secured with rivet(s) as listed.

Sec. 4: Drawings ...

Nº	INDIVIDUAL PART NAME	QTY.	SPI PART Nº	Nº	INDIVIDUAL PART NAME	QTY.	SPI PART Nº
1	Flipper Base Plate Kit (Right)	1	515-6617-00	12	Plunger, Link & Pawl (Rt.) Sub-Assy.	1	515-6518-00
ORDERING ABOVE (ITEM 1) KIT (RIGHT) PART Nº WILL INCLUDE:				ORDERING ABOVE (ITEM 12) SUB-ASSY. PART Nº WILL INCLUDE:			
Note: Flipper Base Plate (Right) comes threaded with all securing hardware (Thread Forming Screws) as listed under each of the items which will get secured to it (Items 2, 3, 6 & 8).				12A Flipper Plunger/Link Sub-Assy. 1 515-6304-01 <i>includes:</i> Plunger "Flipper" Link 1 545-5611-00 <i>includes:</i> Spirol Pin ϕ 5/32" X 3/4" Lg. 1 251-5015-02 <i>includes:</i> Flipper Plunger with "Flat" 1 530-5349-01 12B Pawl (Mntg. Link) (Rt) Sub-Assy. 1 515-6305-00 <i>includes:</i> Pawl (Mounting Link) (Rt.) Plain 1 535-7271-00 <i>includes:</i> © Switch Actuator 1 545-5612-00 <i>includes:</i> Rivet, 1/8" ϕ X 1/4" Lg. 1 249-5003-00			
Item 1 is secured below the playfield by: #10 X 1/2" HWH MS (Serr) Zinc ST (Qty. 8) (237-5949-00)				12C Return Bracket 1 535-7353-00			
2	Flipper Bat Bushing	1	545-5594-00	12D	Flipper Link Bushing (Metal, Ext.) (.385" Lg. X .192" ID X .312" OD)	1	530-5139-01
Item 2 is secured to Item 1 by: #6-32 X 3/8" HWH Swage (Ser.) Zc. (Qty. 3) (237-5976-02)				12E #10-32 X 1-1/4" Lg. Socket Head 1 237-5950-01			
3	1/4" X 3/8" Spacer Gray	2	254-5000-02	12F	#10-32 X 7/8" Lg. Socket Head	1	237-5966-00
Item 3 is secured to Item 1 by: #6-32 X 5/8" HWH Swage (Ser.) Zc. (Qty. 2) (237-5976-04)				12G #10-32 Nylon Stop Nut 2 240-5203-00			
4	Switch Plate/Spring Return Rt. Brkt.	1	535-7354-00	12H	#10 Split Lock Washer	2	244-5003-00
5	Flipper Return Spring	1	265-5035-00	12I	Washer .203" ID X .63" OD X .105" Thk W/cut	1	242-5039-01
6	Coil Stop Bracket Sub-Assembly	1	515-6308-01	12J	Washer .203" ID X .63" OD X .062" Thk	2	242-5038-00
Item 6 is secured to Item 1 by: #10-32 X 3/8" SHWH Swage (Serr) Zinc (Qty. 2) (237-5985-00) and #10 Split Lock Washer (Qty. 2) (244-5003-00)							
7	Spring Washer (17/32" ID X 3/4" X 1")	1	269-5002-00	ASSOCIATED PARTS ARE NOT INCLUDED WITH THE ABOVE ASSEMBLY.			
8	Coil Support Bracket	1	535-7356-00	Nº ASSOCIATED PART NAME QTY. SPI PART Nº			
Item 8 is secured to Item 1 by: #8-32 X 3/8" HWH Swage (Ser.) Zc. (Qty. 2) (237-5975-00)				AP-A YELLOW Flipper Bat & Shaft (Plain) 1 515-5133-06-06			
9	Coil, 23-1500 (BLUE) (Upper Rt.)	1	090-5062-00T	Large Flipper RED Rubber Ring 1 545-5277-22			
ORDERING ABOVE (ITEM 9) COIL PART Nº WILL INCLUDE:							
— Diode, 1N4004 (positioned at top) 1 112-5003-00							
10	Coil Sleeve	1	545-5388-00				
11	Deflector Pad (Bumper)	1	545-5428-00				

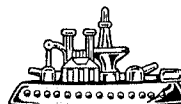

**Bumper Top Assemblies, 515-6459-01 (Qty. 6) (Items 1-7),
 Bumper Bottom Assemblies, 515-6459-04 (Qty. 6) (Items 8-15),
 Bumper Switch Assemblies, 515-6459-03 (Qty. 6) (Items 16-20)
 and Associated Part(s): See Table Below (Item AP-A)**

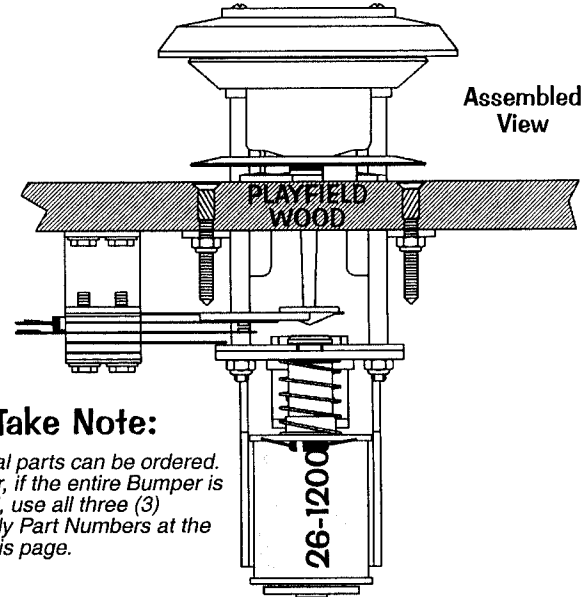
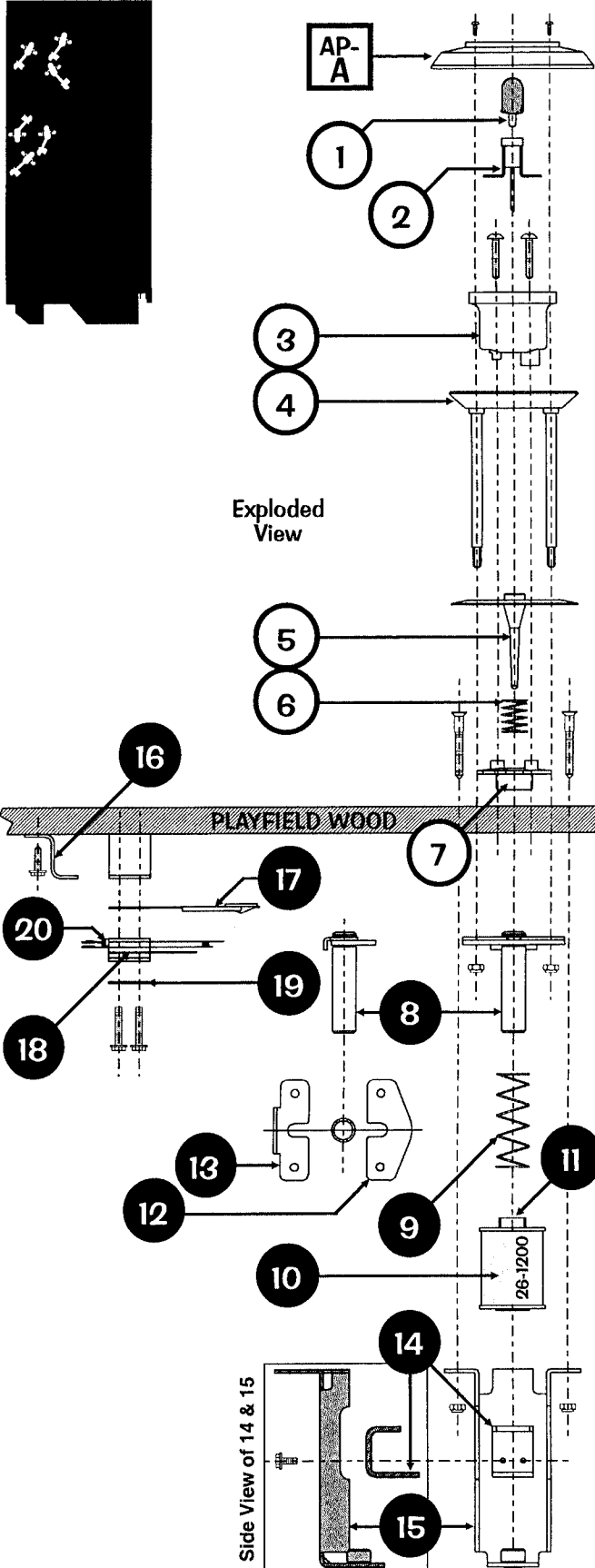

Take Note:

Individual parts can be ordered. However, if the entire Bumper is required, use all three (3) Assembly Part Numbers at the top of this page.

Nº	BUMPER TOP PART NAME	QTY.	SPI PART Nº
1	#555 Wedge Base Bulb	1	165-5002-00
2	#555 Wedge Base Socket	1	077-5206-00
3	Bumper Body	1	545-5197-00
<small>Item 3 is secured by: #5 X 7/8" PRH AB (Zinc) (Qty. 2) (237-5826-00)</small>			
4	Ring Assembly	1	515-5085-00
<small>Item 4 is secured by: #6-32 Nylon Stop Nut (Qty. 2) (240-5005-00)</small>			
5	Bumper Skirt	1	545-5607-00
6	Bumper Skirt Compression Spring	1	266-5048-00
7	Bumper Base	1	545-5195-00

Nº	BUMPER BOTTOM PART NAME	QTY.	SPI PART Nº
8	Plunger	1	530-5348-00
9	Compression (Return) Spring	1	266-5047-00
10	Coil, 26-1200	1	090-5044-00T
ORDERING ABOVE (ITEM 10) COIL PART Nº WILL INCLUDE:			
— Diode, 1N4004 (positioned at top) 1 112-5003-00			
11	Coil Sleeve	1	545-5031-00
12	Fiber Yoke	1	545-5609-00
13	Metal Yoke	1	535-7346-00
14	Metal Yoke Stop	1	535-7347-00
<small>Item 14 is secured by: #6-32 X 1/4" HWH Swage (Serr.) Zinc (Qty. 2) (237-5976-01)</small>			
15	Coil Bracket Welded Assembly	1	515-5939-00
<small>Item 15 is secured by: #6-32 X 1-3/16" Spiral Fin Shank (Qty. 3) (237-5957-00) and #6-32 Nylon Stop Nut (Qty. 3) (240-5005-00)</small>			

Nº	BUMPER SWITCH PART NAME	QTY.	SPI PART Nº
16	Switch Bracket	1	535-7342-00
<small>Item 16 is secured by: #8 X 1/2" SHWH AB (Zinc) (Qty. 2) (234-5101-00)</small>			
17	Spoon Switch Actuator	1	545-5610-01
18	Bumper Stack (Blade) Switch	1	180-5015-03
19	Switch Body Protect Plate	1	535-7344-00
<small>Items 18 & 19 are secured by: #6-32 X 3/4" HWH Swage (Serr.) Zc. (Qty. 2) (237-5976-05)</small>			
20	Switch Diode, 1N4001	1	112-5001-00
<small>The Top & Bottom Assemblies are secured together by hardware included in assemblies.</small>			

Nº	ASSOCIATED PART NAME	QTY.	SPI PART Nº
<small>ASSOCIATED PART IS NOT INCLUDED WITH THE ABOVE ASSEMBLY.</small>			
	Bumper Cap (Red)	2	550-5057-02
	Bumper Cap (Clear)	2	550-5057-01
AP-A	Bumper Cap, Altered (Cut) (Red)	1	550-5076-02
	Bumper Cap, Altered (Cut) (Clear)	1	550-5074-01
<small>Item AP-A is secured to Item 4 by: #4 X 3/4" PRH (Zinc) T-25 (Qty. 2/per) (237-5873-00)</small>			

Sec. 4: Drawings ...



Slingshot Assemblies, 500-5849-00 (Qty. 2) (Items 1-10)

Nº	INDIVIDUAL PART NAME	QTY.	SPI PART Nº
1	Slingshot Bracket Assembly	1	515-5339-01
Item 1 is secured below the playfield by: #8 X 1/2" HWH AB (Zinc) (Qty. 3) (234-5101-00)			
2	Coil Retaining Bracket	1	535-5203-03
Item 2 is secured to Item 1 by: #8-32 X 3/8" PPH MS (Sems) (Qty. 2) (232-5301-00)			
3	Coil, 23-800	1	090-5001-00T
ORDERING ABOVE (ITEM 3) COIL PART Nº WILL INCLUDE:			
—	Diode, 1N4004 (positioned at top)	1	112-5003-00
4	Coil Sleeve	1	545-5031-00
5	Plunger & Link Assembly	1	515-5338-00
ORDERING ABOVE (ITEM 5) SUB-ASSY. PART Nº WILL INCLUDE:			
5A	Plunger 2" Lg.	1	530-5025-01
5B	Plunger Link	1	545-5293-00
5C	Roll Pin 1/8" ø x 5/8" Lg.	1	251-5008-00
Item 5B is secured to Item 10A by: Retaining Ring, 1/4" ø Shaft (Qty. 1) (270-5002-00)			
Ordering Note: If 515-5338-00 is unavailable, order the individual part(s) actually required.			
6	Compression (Return) Spring	1	266-5020-00
7	Slingshot Stack (Blade) Switch	2	180-5054-00
8	Switch Body Protect Plate	2	535-5045-00
Items 7 & 8 are secured to Item 1 by: #6-32 X 5/8" HWH Swage (Qty. 4) (237-5976-04)			
9	Switch Diode, 1N4001	2	112-5001-00
10Ⓜ	Riveted Arm & Tip Assembly	1	515-5340-01
ORDERING ABOVE @ RIVETED ASSY. PART Nº WILL INCLUDE:			
10A	Arm	1	515-5341-01
10B	Kicker Tip (secured to 1A by 1C)	1	545-5216-01
10C*	Rivet, 1/8" ø x 1/4" Lg.	1	249-5003-00
Item 10A is secured to Item 1 by: Retaining Ring, 1/4" ø Shaft (Qty. 1) (270-5002-00)			
Ordering Note: If 515-5340-01 is unavailable, order the individual part(s) actually required.			

Take Note:

- * An asterisk (*) indicates item(s) are not noted in the pictorials.
- Ⓜ "R" indicates Item noted is secured with rivet(s) as listed.

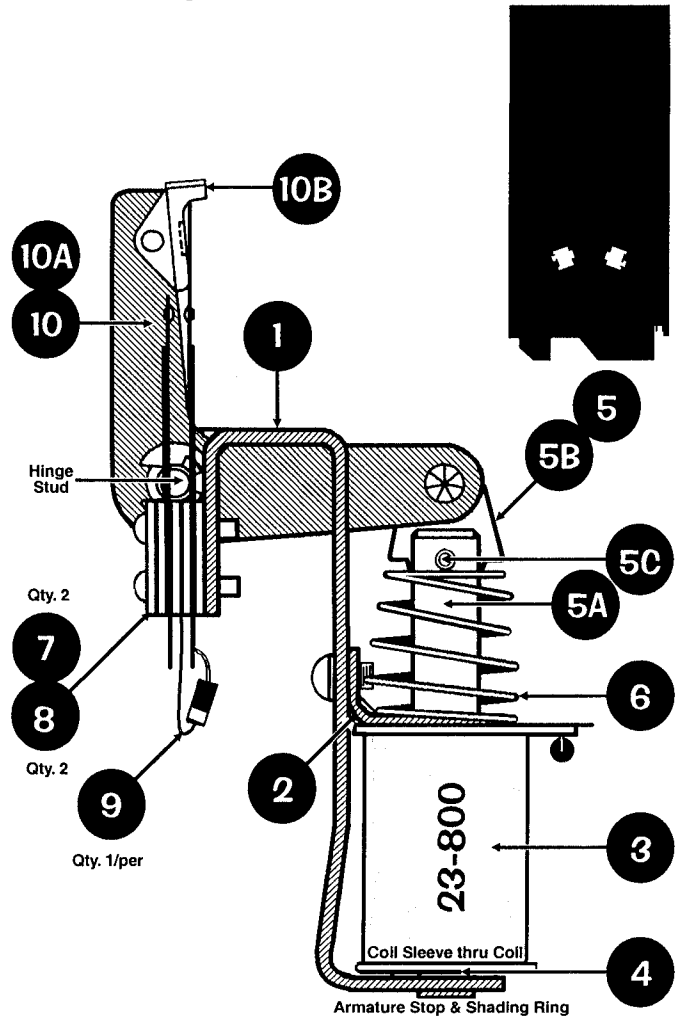

Kick Big (Laser Kick) Assembly, 500-5862-02 (Items 1-8)

Sec. 4: Drawings ...

Nº	INDIVIDUAL PART NAME	QTY.	SPI PART Nº
1	Mounting Bracket (Frame)	1	535-6730-00
Item 1 is secured above the playfield by: #8 X 1/2" HWH AB (Zinc) (Qty. 3) (234-5101-00)			
2	Coil Retaining Bracket	1	535-5203-03
Item 2 is secured to Item 1 by: #8-32 X 1/4" PPH MS (Sems) (Qty. 2) (232-5300-00)			
3	Coil, 23-800	1	090-5001-00B
ORDERING ABOVE (ITEM 3) COIL PART Nº WILL INCLUDE:			
—	Diode, 1N4004 (positioned at bottom)	1	112-5003-00
4	Coil Sleeve (Short) (Formost #10-7077)	1	545-5076-01
5	Spring Washer (17/32" ID X 3/4" X 1")	1	269-5002-00
6	Plunger Assembly	1	515-5000-02
7	Compression (Return) Spring	1	266-5020-00
8	Rubber Bumper (Grommet)	1	545-5105-00
Ordering Note: If 500-5862-02 is unavailable, order the individual part(s) actually required or try -00 or -01 and change the coil position to match -02 (-00 Coil Lugs Face Up; -01 Coil Lugs Face Left; -02 Coil Lugs Face Right).			

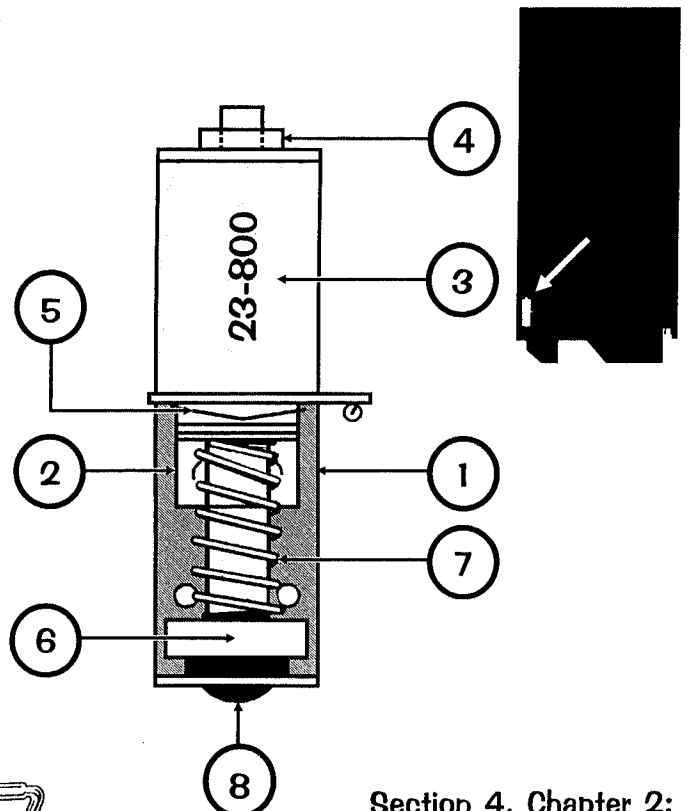

30° Eject Assembly, 500-6511-00 (Items 1-8)

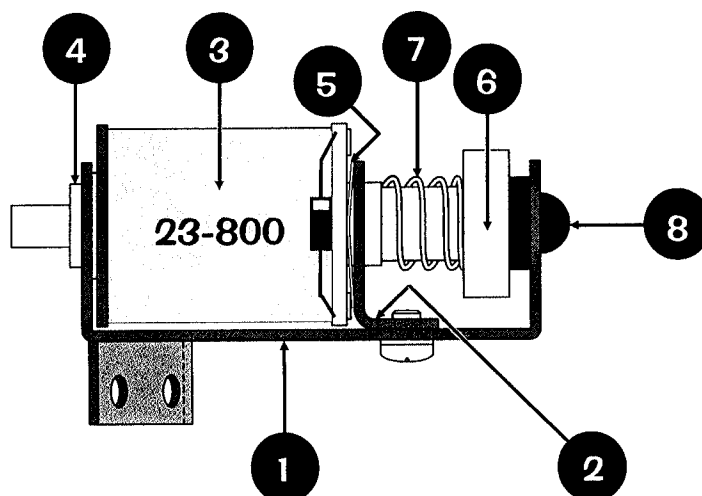
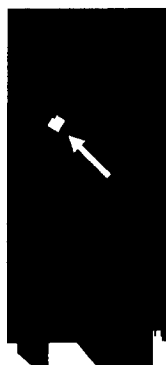

Nº	INDIVIDUAL PART NAME	QTY.	SPI PART Nº	Nº	INDIVIDUAL PART NAME	QTY.	SPI PART Nº
1	Mounting Bracket 30° Bend (Frame)	1	535-8932-00	4	Coil Sleeve (Short) (Formost #10-7077)	1	545-5076-01
Item 1 is secured below the playfield by: #8 X 1/2" HWH AB (Zinc) (Qty. 2) (234-5101-00)							
2	Coil Retaining Bracket	1	535-5203-03	5	Spring Washer (17/32" ID X 3/4" X 1")	1	269-5002-00
Item 2 is secured to Item 1 by: #8-32 X 1/4" PPH MS (Sems) (Qty. 2) (232-5300-00)							
3	Coil, 23-800	1	090-5001-00T	6	Plunger Assembly	1	515-7197-00
ORDERING ABOVE (ITEM 3) COIL PART Nº WILL INCLUDE:							
—	Diode, 1N4004 (positioned at top)	1	112-5003-00	7	Compression (Return) Spring	1	266-5020-00
				8	Rubber Bumper (Grommet)	1	545-5105-00
Ordering Note: If 500-6511-00 is unavailable, order the individual part(s) actually required or try -01 and change the coil to 23-800 (090-5001-00T).							

30° Eject Assembly, 500-6511-01 (Items 1-8)

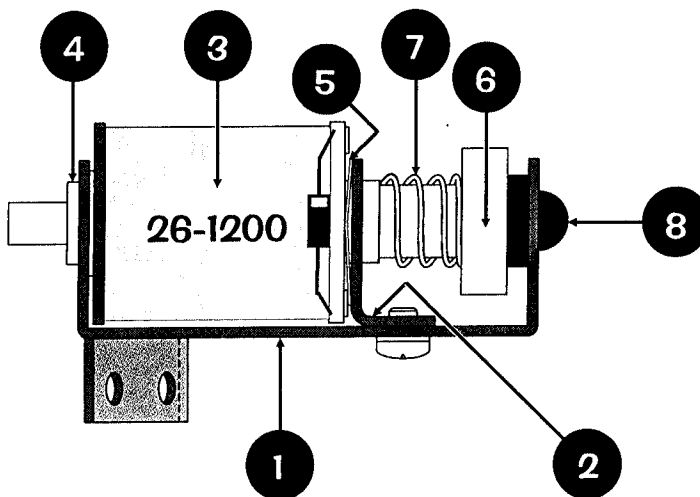

Nº	INDIVIDUAL PART NAME	QTY.	SPI PART Nº	Nº	INDIVIDUAL PART NAME	QTY.	SPI PART Nº
1	Mounting Bracket 30° Bend (Frame)	1	535-8932-00	4	Coil Sleeve (Short) (Formost #10-7077)	1	545-5076-01
Item 1 is secured below the playfield by: #8 X 1/2" HWH AB (Zinc) (Qty. 2) (234-5101-00)							
2	Coil Retaining Bracket	1	535-5203-03	5	Spring Washer (17/32" ID X 3/4" X 1")	1	269-5002-00
Item 2 is secured to Item 1 by: #8-32 X 1/4" PPH MS (Sems) (Qty. 2) (232-5300-00)							
3	Coil, 26-1200	1	090-5044-00T	6	Plunger Assembly	1	515-7197-00
ORDERING ABOVE (ITEM 3) COIL PART Nº WILL INCLUDE:							
—	Diode, 1N4004 (positioned at top)	1	112-5003-00	7	Compression (Return) Spring	1	266-5020-00
				8	Rubber Bumper (Grommet)	1	545-5105-00
Ordering Note: If 500-6511-01 is unavailable, order the individual part(s) actually required or try -00 and change the coil to 26-1200 (090-5044-00T).							

Sec. 4: Drawings ...

Ball Deflector Assembly, 500-6433-00 (Items 1-9)

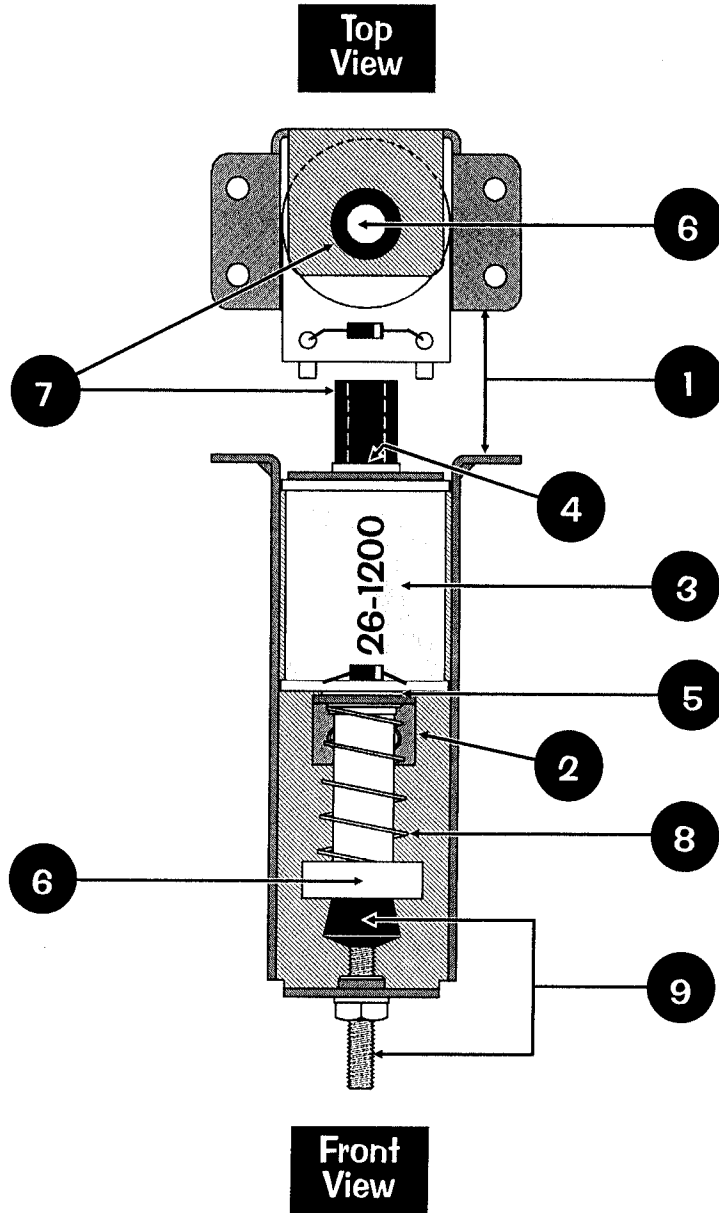

Sec. 4: Drawings ...

Nº	INDIVIDUAL PART NAME	QTY.	SPI PART Nº	Nº	INDIVIDUAL PART NAME	QTY.	SPI PART Nº
1	Ball Deflector Coil Mounting Bracket	1	535-6857-02	5	Spring Washer (17/32" ID X 3/4" X 1")	1	269-5002-00
Item 1 is secured below the playfield by: #6 X 1/2" HWH AB (Zinc) (Qty. 4) (234-5001-02)				6	Solid Plunger Assembly (Tapered Top)	1	515-7089-00
2	Coil Retaining Bracket	1	535-5203-03	7	Post Black Rubber (Sleeve Tall)	1	545-5308-00
Item 2 is secured to Item 1 by: #8-32 X 1/4" PPH MS (Sems) (Qty. 2) (232-5300-00)				8	Compression (Relay) Spring	1	266-5022-01
3	Coil, 26-1200	1	090-5044-00T	9	#10-32 Adj. Spindle Stop w/Rubber Tip.	1	280-5014-00
ORDERING ABOVE (ITEM 3) COIL PART Nº WILL INCLUDE:				Item 9 is secured by: #10-32 Keps Nut (Qty. 1) (240-5208-00)			
—	Diode, 1N4004 (positioned at top)	1	112-5003-00	Ordering Note: If 500-6433-00 is unavailable, order the individual part(s) actually required or try 500-5788-02 and change it's Solid Plunger (515-6858-00) with above Solid Plunger (515-7089-00) and add the Post Rubber Sleeve (545-5308-00).			
4	Coil Sleeve (Short) (Formost #10-7077)	1	545-5076-01				



Scoop [Kicker] Assembly, 500-6491-00 (Items 1-12)

Top View

NOTE: The Scoop Exit Top has the corners cut with 45° angles. Ensure SPI Part N° used is 515-7165-01.

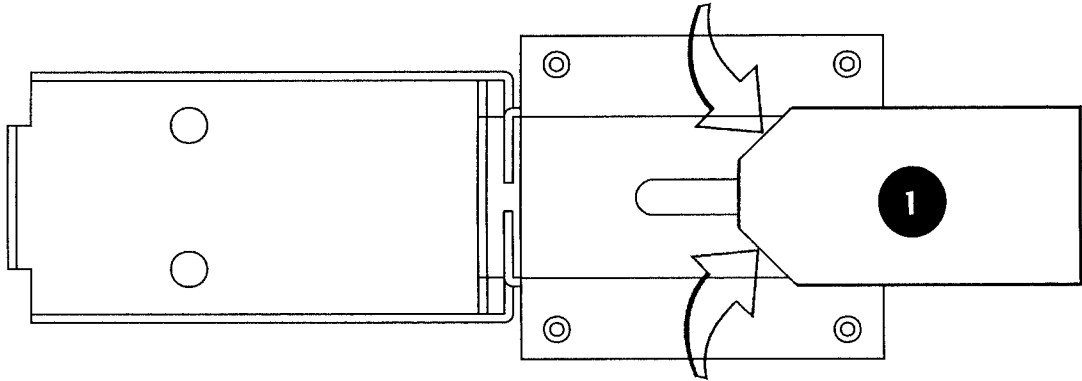

Side View

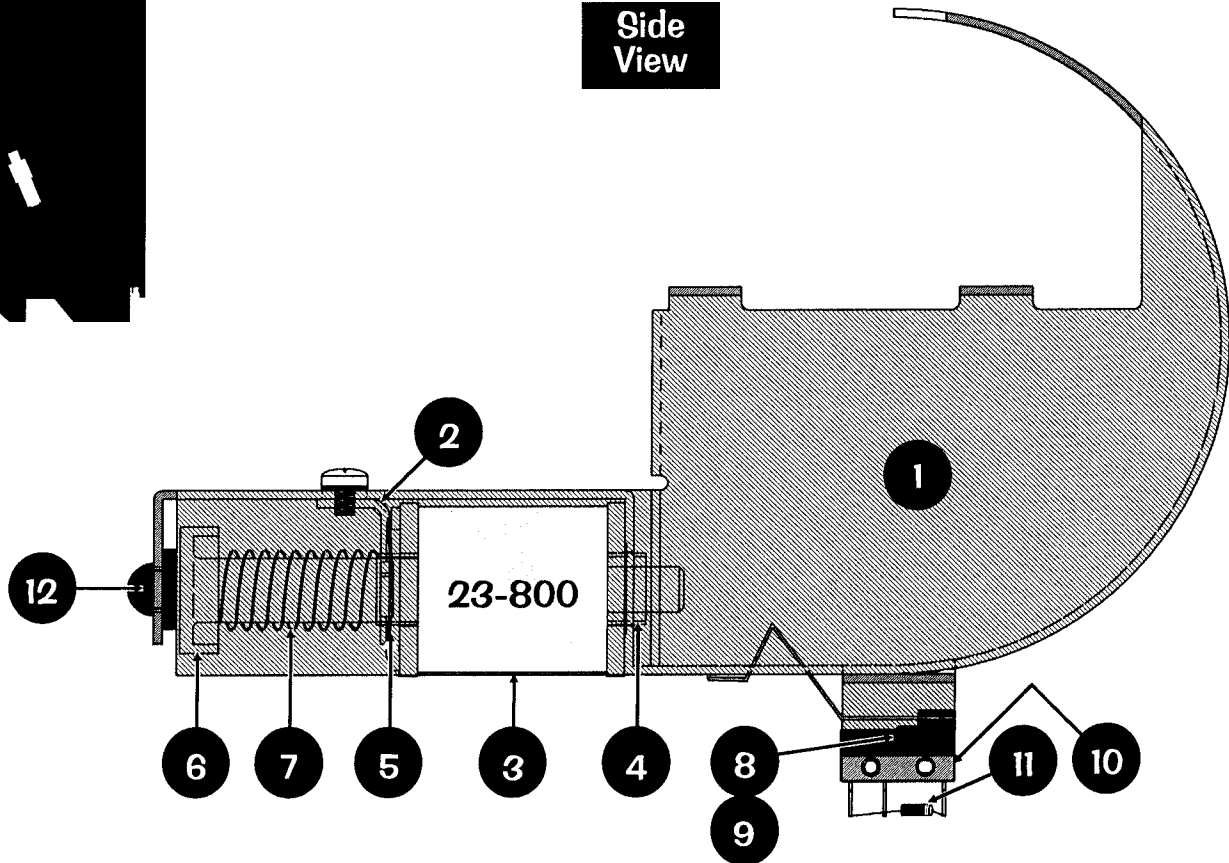
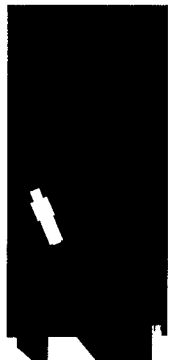

Sec. 4: Drawings ...

N°	INDIVIDUAL PART NAME	QTY.	SPI PART N°	N°	INDIVIDUAL PART NAME	QTY.	SPI PART N°
1	Scoop Weldment w/cut corners @ top	1	515-7165-01	7	Compression (Return) Spring	1	266-5020-00
Item 1 is secured below the playfield by: #8 X 1/2" HWH AB (Zinc) (Qty. 4) (234-5101-00)				8	Insulation Fiche Paper <i>between</i> Items 9 & 1	1	545-6029-00
2	Coil Retaining Bracket	1	535-5203-03	9	Micro Switch	1	180-5183-00
Item 2 is secured by: #8-32 X 1/4" PPH MS (Sems) Zinc (Qty. 2) (232-5300-00)				10	Switch Body Protect Plate	1	535-6539-00
3	Coil, 23-800	1	090-5001-00B	Items 8 - 10 are secured to Item 1 by: #2-56 X 1/2" HWH Ser UNS #4HD TRS 90 (Qty. 2) (237-5937-02) and #2-56 Hex Nut (Qty. 2) (240-5301-00)			
ORDERING ABOVE (ITEM 3) COIL PART N° WILL INCLUDE:							
—	Diode, 1N4004 (positioned at bottom)	1	112-5003-00	11	Switch Diode, 1N4001	1	112-5001-00
4	Coil Sleeve (Short) (Formost #10-7077)	1	545-5076-01	12	Rubber Bumper (Grommet)	1	545-5105-00
5	Spring Washer (17/32" ID X 3/4" X 1")	1	269-5002-00	Ordering Note: If 500-6491-00 is unavailable, order the individual part(s) actually required. Ensure your assembly has the Scoop Weldment with <i>cut corners at exit top</i> (515-7165-01).			
6	Plunger Assembly	1	515-5000-02				



1-Bank Drop Target Assembly, 500-6440-21 (Items 1-20)

The Parts Table for this assembly is on the next page.

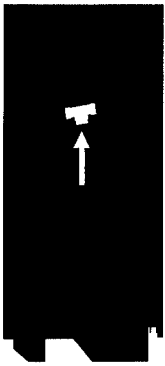

Top View

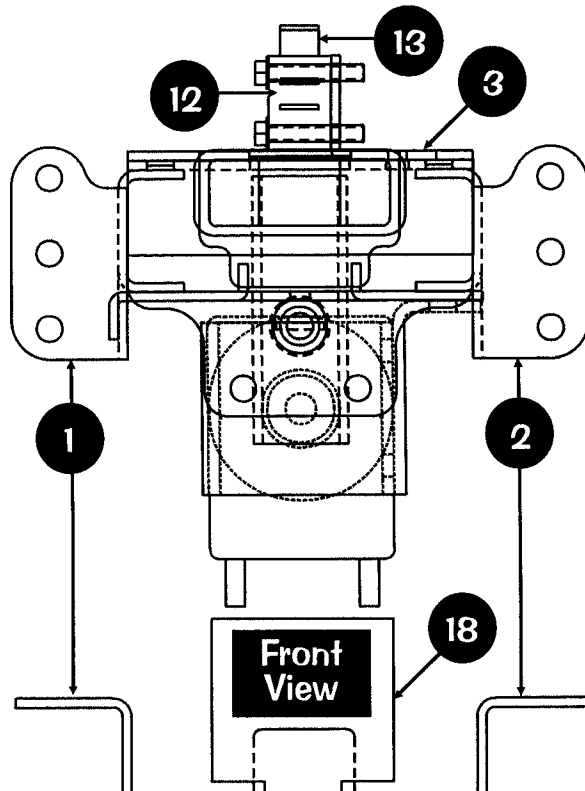

For Securing Hardware, see the Parts Table on the next page, under item desired.

Side View

DOTS: The Switch Diode is located on a Terminal Strip under the playfield near this assembly. See Section 5, Chapter 2, Playfield Wiring, Page 95, for more details.

Trip Coil Not Required



Sec. 4: Drawings ...

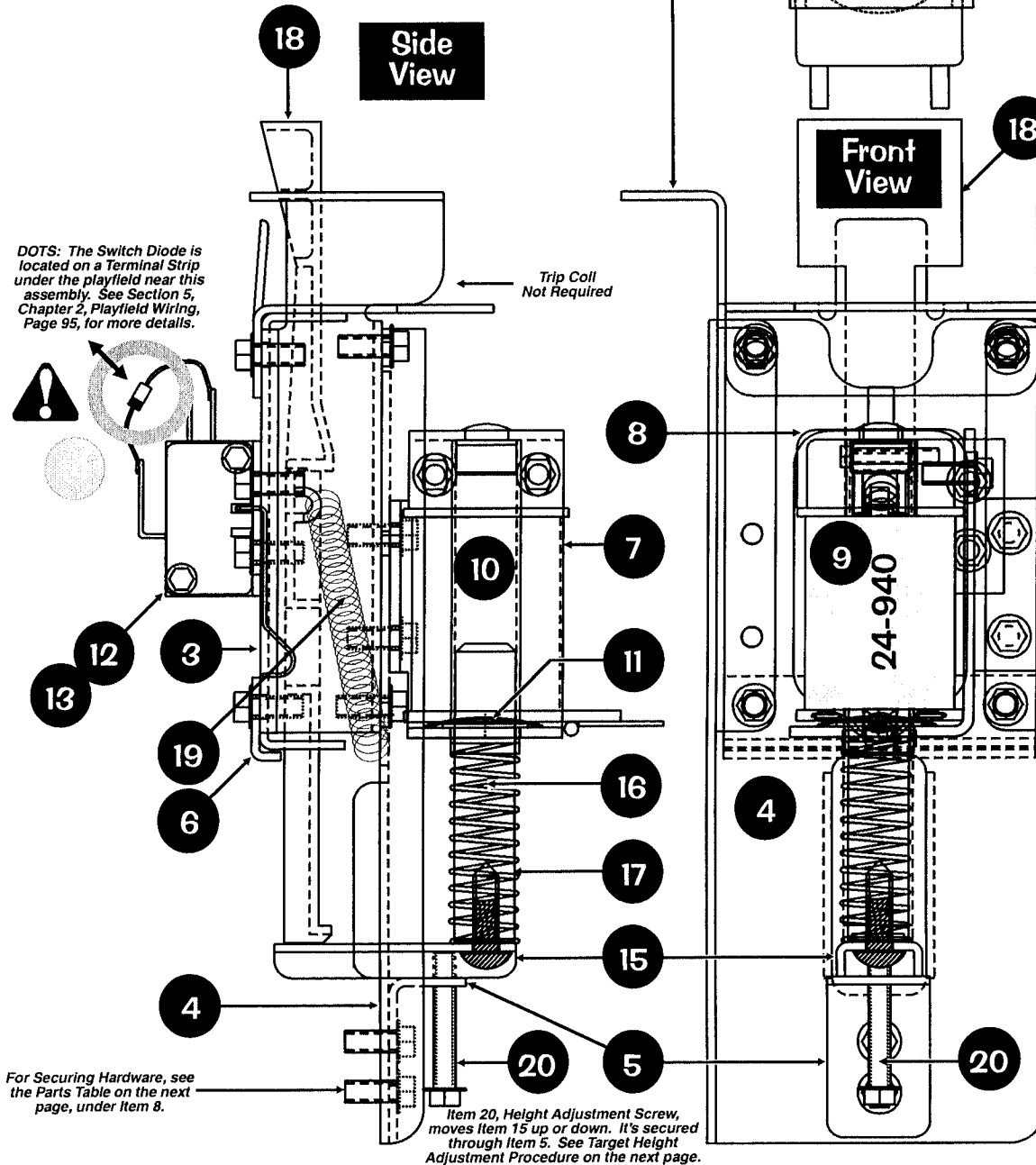

For Securing Hardware, see the Parts Table on the next page, under item 8.

Item 20, Height Adjustment Screw, moves Item 15 up or down. It's secured through Item 5. See Target Height Adjustment Procedure on the next page.



1-Bank Drop Target Assembly, 500-6440-21 (Items 1-20) Continued

The Drawings for this assembly are on the previous page.

Nº	INDIVIDUAL PART NAME	QTY.	SPI PART Nº	Nº	INDIVIDUAL PART NAME	QTY.	SPI PART Nº
1	Bracket Drop Target (Left Side)	1	535-8746-00	12	Bracket, Switch (1-Bank D/T)	1	535-7710-00
2	Bracket Drop Target (Right Side)	1	535-8746-01	13	Switch (D/T)	1	180-5158-00
Items 1 & 2 are secured below the playfield by: #8 X 1/2" HWH AB (Zinc) (Qty. 3/per) (234-5101-00)				Item 13 is secured to Item 12 by: #4-40 X 5/8" HWH TF (Qty. 2) (237-5945-00)			
3	Back Plate (1-Bank Drop Target)	1	535-7713-00	14	Switch Diode, 1N4001	0	112-5001-00
4	Bracket, Support (1-Bank D/T)	1	535-7712-00	See "Take Note" below.			
5	Bracket, Height Adjustment	1	535-7709-01	15	Bracket, Target Lift (1-Bank D/T)	1	535-7706-01
6	Bracket, Target Retainer (1-Bank D/T)	1	535-7728-00	16	Plunger (Drive Coil)	1	530-5410-00
7	Bracket, Coil Housing	1	535-7707-00	Item 16 is secured to Item 15 by: #10-32 X 3/8" PPH (Sems) (Qty. 1) (232-5401-00)			
8	Bracket Cap, Coil Housing	1	515-6533-00	To order Items 15-16 assembled with securing hardware, use SPI Nº: 515-6537-00.			
Items 1-3, 5, 7-8 are secured to Item 4 by: #8-32 X 3/8" HWH Swg. (Qty. 16) (237-5975-00)				17	Compression (Return) Spring	1	266-5020-00
9	Coil, 24-940	1	090-5036-00B	18	Drop Target White (Rollover Target)	1	545-5533-01
ORDERING ABOVE (ITEM 9) COIL PART Nº WILL INCLUDE:				Note: Individual Decal Not Available. The entire decal sheet must be ordered for replacement. See Page 57 for part number.			
—	Diode, 1N4004 (positioned at bottom)	1	112-5003-00	19	Spring, Target Reset	1	265-5003-00
10	Coil Sleeve	1	545-5709-00	20	Height Adj. Screw (#8-32 X 1" HWH)	1	237-6003-00
11	Spring Washer (17/32" ID X 3/4" X 1")	1	269-5002-00	Ordering Note: If 500-6440-21 is unavailable, order the individual part(s) actually required or try 500-6440-01 and remove the Trip Coil & Bracket from Item 4 (Note: Item 5, Height Adj. Bracket may differ slightly). Also, ensure the diode on the switch is soldered correctly.			
To order Items 7-11 assembled with securing hardware, use SPI Nº: 515-6535-01.							

Take Note:

The Switch Diode, 1N4001, is not located on this assembly (nor included); it's located on a Terminal Strip under the playfield. See Section 5, Chapter 2, Playfield Terminal Strips..., Page 95.

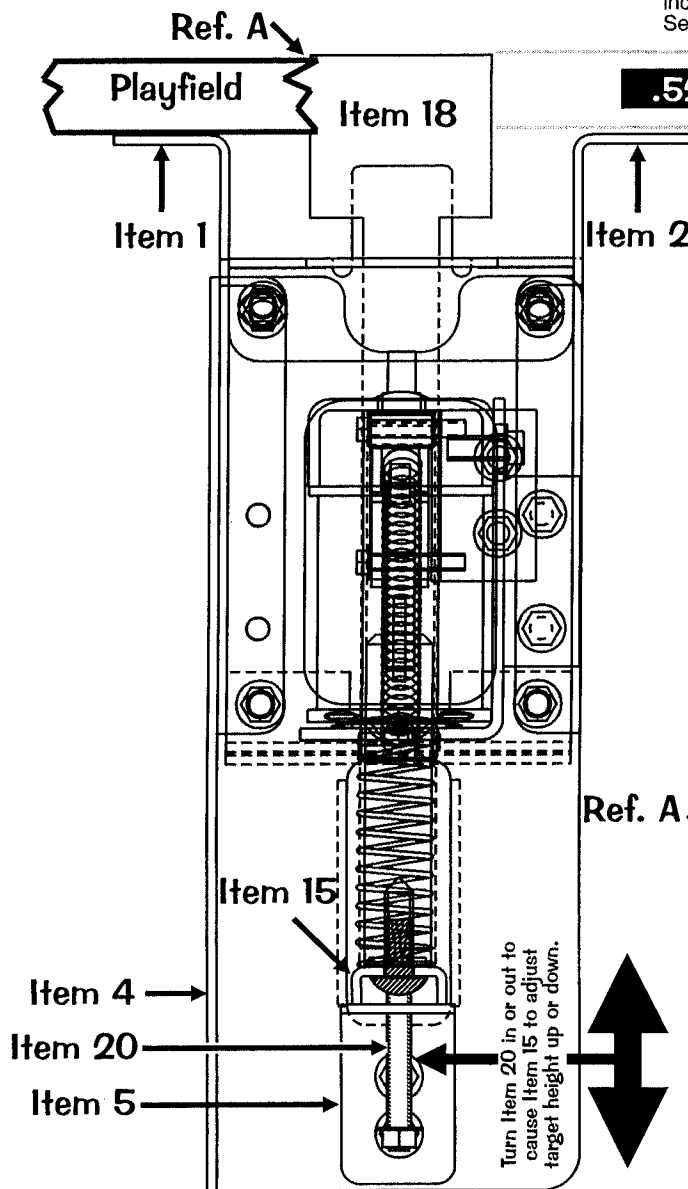

Target Height Adjustment Procedure:

1. Adjust the height of the top of **Item 18** (Rollover Target) at .52" (+/- .01"), relative to **Items 1 & 2** (Left & Right Side Brackets), as shown left. Adjustment should be made with **Item 18** (Drop Target) in the **DOWN POSITION**.

Keep in Mind: This adjustment procedure should have the **TOP SIDE** of **Item 18** (Drop Target) "flush to slightly above" the playfield surface after reinstalling to the underside of the Playfield. This will ensure a **BALL TRAP** is not created where the ball can rest in the target hole above the playfield.

2. Using a Flat Head Screwdriver or a 1/4" Nut Driver, loosen or tighten (turn in or out) **Item 20** (Height Adjustment Screw) through **Item 5** (Height Adjustment Bracket) to raise or lower **Item 15** (Target Lift Bracket) causing **Item 18** (Drop Target) to reach desired height as stated above.

Sec. 4: Drawings ...



MONOPOLY® Bank Assembly, 500-6512-00 (Items 1-20)

The Parts Table for this assembly is on the next page.

Not sold as an assembly, order the individual part(s) actually required.

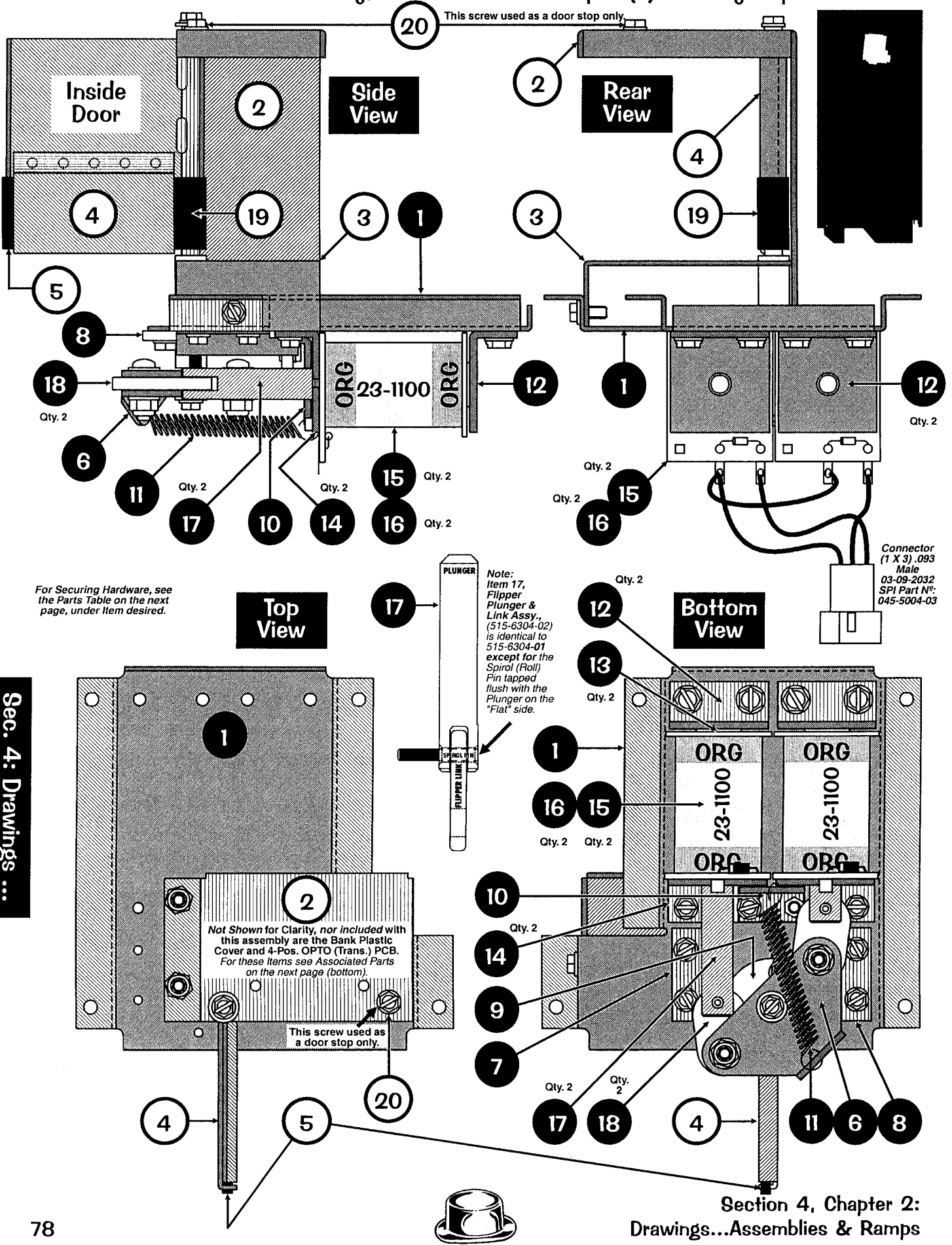

Sec. 4: Drawings ...

MONOPOLY® Bank Assembly, 500-6512-00 (Items 1-20) Continued
 The Drawings for this assembly are on the previous page, also reference pictures below.
 Not sold as an assembly, order the individual part(s) actually required.

Nº	INDIVIDUAL PART NAME	QTY.	SPI PART Nº	Nº	INDIVIDUAL PART NAME	QTY.	SPI PART Nº		
1	Bottom Mounting Bracket	1	535-8924-00	12	Coil Stop Bracket Sub-Assembly	2	515-6308-01		
Item 1 is secured below the playfield by: #8 X 1/2" HWH AB (Zinc) (Qty. 4) (234-5101-00)				Item 12 is secured to Item 1 by: #10-32 X 3/8" SHWH Swg. (Sr.) Zc. (Qty. 2) (237-5985-00)					
2	Housing (Left Wall & Ceiling) Bracket	1	535-8926-00	13	Spring Washer (17/32" ID X 3/4" X 1")	2	269-5002-00		
Item 2 is secured to Item 1 at Perm Studs by: #8-32 Nylon Stop Nut (Qty. 2) (240-5102-00)				Item 14 is secured to Item 1 by: #8-32 X 3/8" HWH Swage (Serr) Zinc (Qty. 1/per) (237-5975-00) and secured by Item 10					
3	Floor (Bracket)	1	535-8925-00	15	Coil, 23-1100 (ORG)	2	090-5030-00T		
Item 3 is secured to Item 1 at side by: #8-32 X 3/8" HWH Swage (Serr) Zinc (Qty. 2) (237-5975-00) and is secured into Item 2's slot holes.				ORDERING ABOVE (ITEM 15) COIL PART Nº WILL INCLUDE:					
4	Door	1	515-7222-00	—	Diode, 1N4004 (positioned at top)	1/per	112-5003-00		
Item 4 is secured at the top by: #6-32 X 3/8" HWH Swg. (Sr.) Zinc (Qty. 1) (237-5976-02) and #6 Washer (Qty. 1) (242-5001-00) Note: Door with no pad use 535-8927-00				16 Coil Sleeve				2	545-5388-00
ORDERING DOOR (ITEM 4) WILL INCLUDE RUBBER PAD (ITEM 5) ATTACHED.									
5	Impact Blue Rubber Pad (Self-Adhesive)	1	545-5994-00	17	Flipper Plunger & Link Sub-Assy.	2	515-6304-02		
6	Toggle Bracket	1	535-8929-00	includes: Plunger "Flipper" Link 1 545-5611-00					
Item 6 is secured at the center by: #6-32 X 3/8" HWH Swage (Serr) Zinc (Qty. 1) (237-5976-02) and #6 Washer (Qty. 1) (242-5001-00)				includes: Spirol Pin ø 5/32" X 3/4" Lg. See Note 1 251-5015-02					
7	Roll-Pin Guide Bracket, Left	1	535-9015-00	include: Flipper Plunger with "Flat" 1 530-5349-01					
8	Roll-Pin Guide Bracket, Right	1	535-9015-01	Ordering Note: If 515-6304-02 is unavailable, order the individual part(s) actually required, or try 515-6304-01 and tap the Spirol Pin flush with the Plunger on the "Flat" side (all parts otherwise are identical).					
9	Flipper Bat Bushing	1	545-5594-00	18	Flipper Link Bushing (Metal, Ext.)	2	530-5139-01		
Items 7-9 are secured to Item 1 by: #6-32 X 3/8" HWH Sw. (Sr.) Zc. (Qty. 7) (237-5976-02)				Specifications: .385" Lg. X .192" ID X .312" OD					
10	Spring Bracket	1	535-8928-00	Item 18 is secured to Item 6 by: #8-32 X 3/4" PPH MS (Zinc) (Qty. 2/per) (237-5604-00), #8 Washer (Qty. 2/per) (242-5005-00) and #8-32 Nylon Stop Nut (Qty. 2/per) (240-5102-00)					
Item 10 is secured to both Item 14's by: #8-32 X 3/8" HWH Swage (Serr) Zinc (Qty. 1) (237-5975-00) and 1/4" X 1/4" Hex Spacer, #8-32 Tap (Qty. 1) (254-5031-01)				19	Post Black Rubber (Sleeve Tall)	1	545-5308-00		
11	Flipper Return Spring	1	265-5035-00	20	"Door Stop" #8-32 X 3/8" HWH Sw.	1	237-5975-00		
				Ordering Note: If 500-6512-00 is unavailable, order the individual part(s) actually required.					

Associated Parts: Bank Plastic Cover, 4-Pos. OPTO (Trans. & Rec.) PCBs (Items AP-A - AP-C)

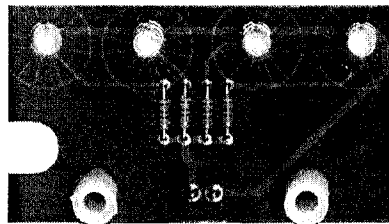
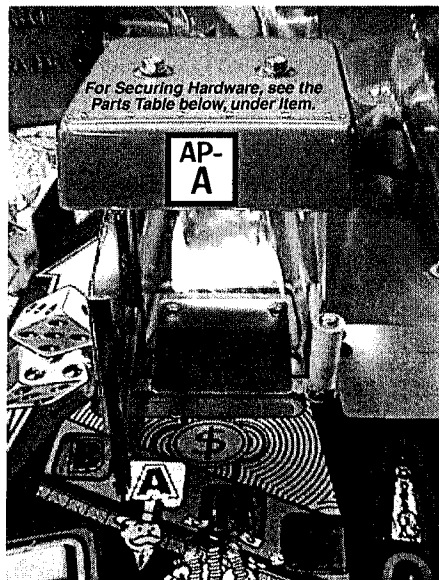

AP-B
Top View

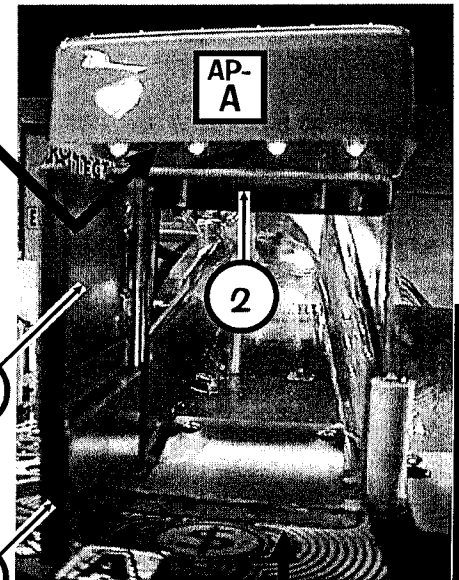

4

5

Take Note:

The Individual Decal (BANK) is Not Available.
 The entire decal sheet must be ordered for replacement. See Page 57 for part number.

Take Note:

For a break-down of parts of Items AP-B & AP-C (below), see Sec. 5, Chp. 4, 4-Position OPTO (Receiver) PC Board Component Layout & Parts, Page 130, or 4-Position OPTO (Transmitter) PC Board Component Layout & Parts, Page 131.

Nº	INDIVIDUAL PART NAME	QTY.	SPI PART Nº
AP-A	Bank Plastic Cover	1	545-6008-00
	1/2" Slf. Rtn. #8 Spacer White	2	254-5032-01
Item A is secured to Item 2 (Housing Bracket above) by: #8-32 X 1-1/2" HWH Swage (Zinc) (Qty. 2) (237-6065-00)			
AP-B	4-Pos. OPTO (Trans.) PCB & Cable	1	520-5218-00
	1/2" Slf. Rtn. #8 Spacer White	2	254-5032-01
Item B is secured inside Item A (Bank Plastic Cover), see Item A for securing hardware.			
AP-C	4-Position OPTO (Receiver) PCB	1	520-5210-00
	3/8" Slf. Rtn. Spacer White	2	254-5007-01
Item is secured below the playfield by: #6 X 7/8" HWH AB Zinc (Qty. 2) (234-5003-01)			

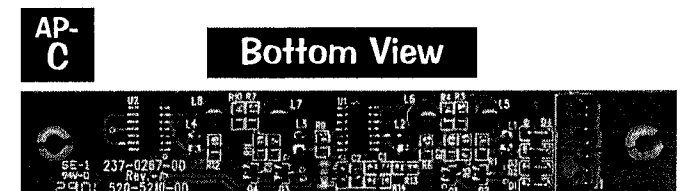
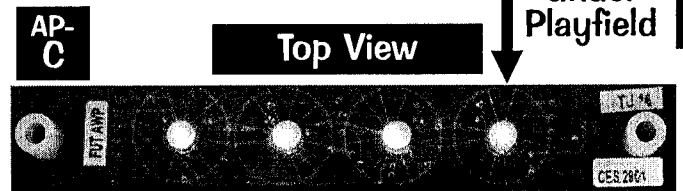

Sec. 4: Drawings ...



Mini-Flipper & Motor Assembly, 500-6486-00 (Items 1-10)
 The Parts Table for this assembly is on the next page.
 Not sold as an assembly, order the individual part(s) actually required.

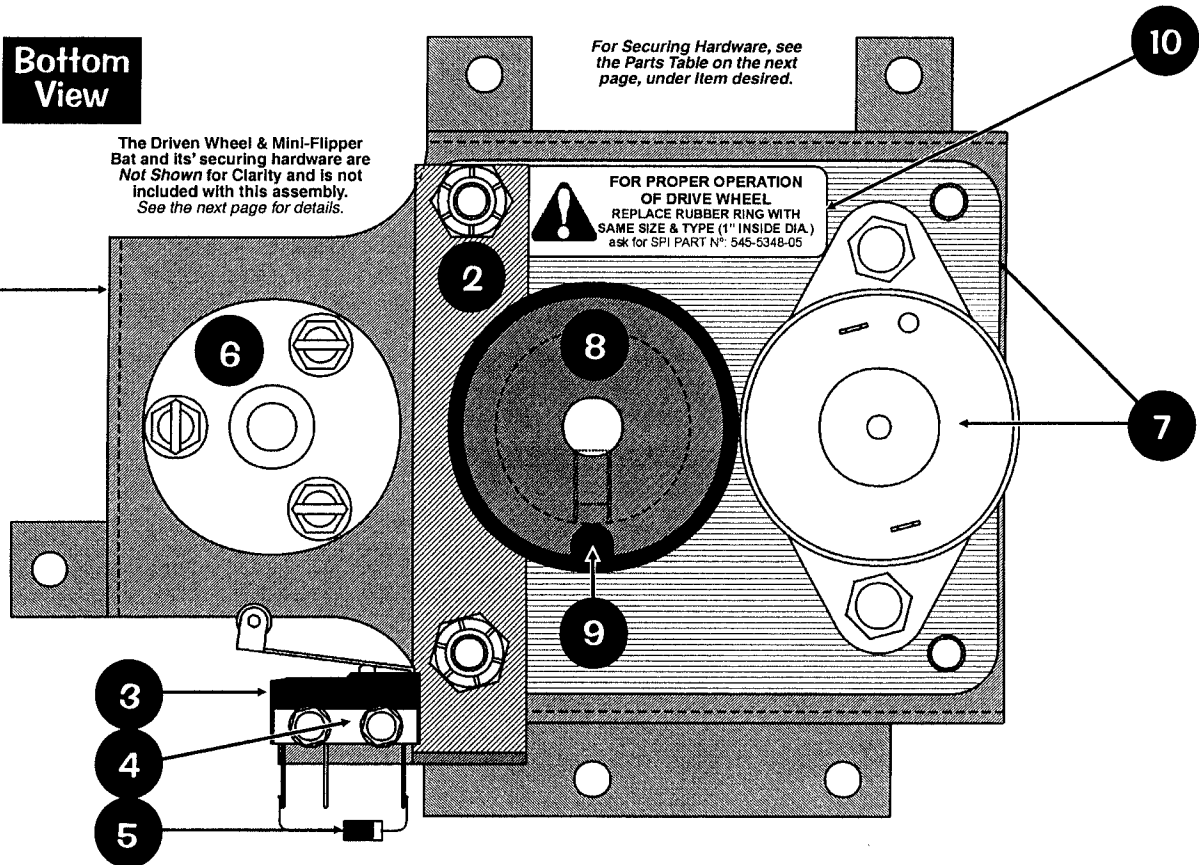
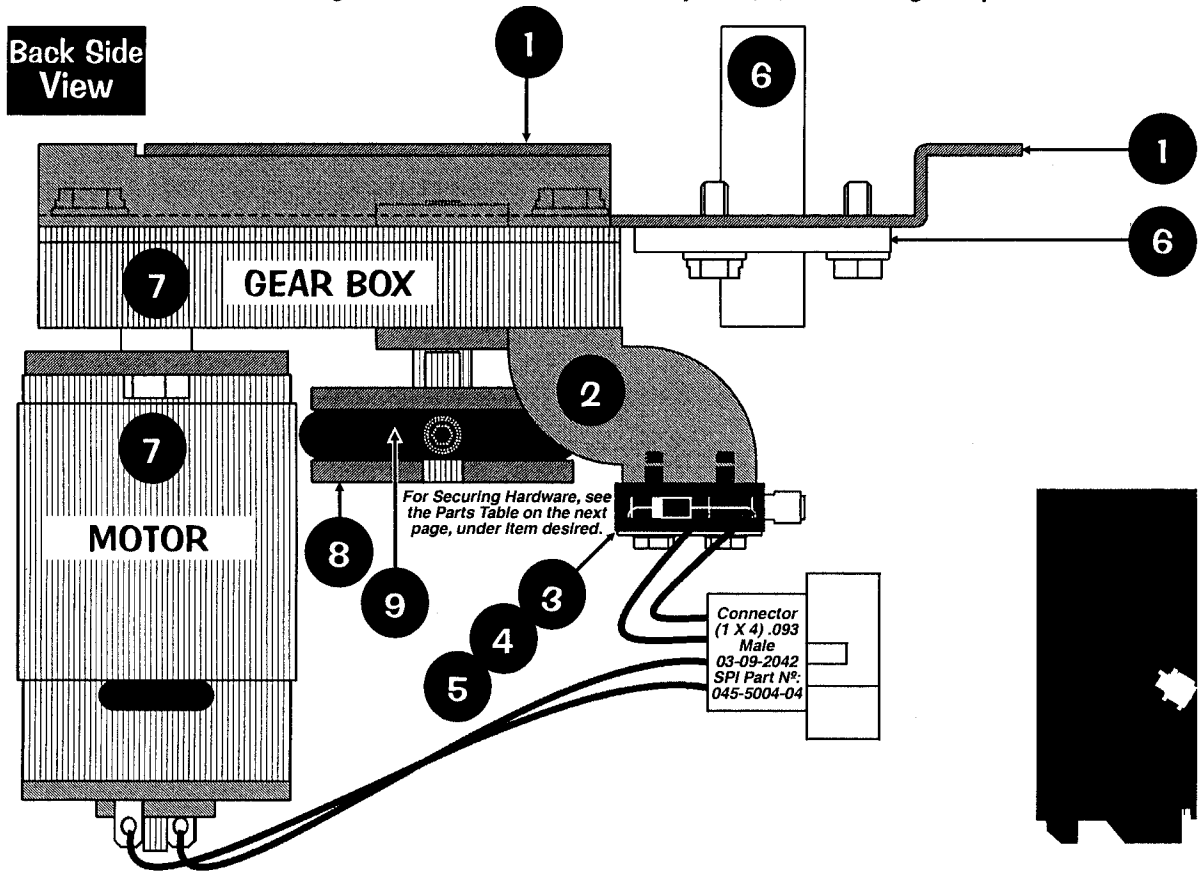

Sec. 4: Drawings ...



Mini-Flipper & Motor Assembly, 500-6486-00 (Items 1-10) Continued
 The Drawings for this assembly are on the previous page, also reference picture below.
 Not sold as an assembly, order the individual part(s) actually required.

Nº	INDIVIDUAL PART NAME	QTY.	SPI PART Nº	Nº	INDIVIDUAL PART NAME	QTY.	SPI PART Nº
1	Mounting Bracket (for rotating flipper)	1	535-8930-00	7	Motor & Gear Box	1	041-5083-00
Item 1 is secured below the playfield by: #8 X 1/2" HWH AB (Zinc) (Qty. 5) (234-5101-00)							
2	Switch Bracket (for rotating flipper)	1	535-8931-00	Motor Specifications: Multi-Products #7000 EX00159A 20v DC 85 RPM CW/CCW			
Item 2 is secured to Item 6 (Gear Box Part) through Item 1 by: #10-32 X 1" HWH MS (Zinc) (Qty. 2) (237-5811-00) and #10-32 Nylon Stop Nut (Qty. 2) (240-5203-00)							
3	Micro Switch (Roller Actuator)	1	180-5119-00	8	Drive Wheel (with single-groove edge)	1	530-5598-00
4	Switch Body Protect Plate	1	535-6539-00	Item 7 is secured to Item 1 by: #10-32 X 1/2" HWH (Serr) Zinc (Qty. 2) (237-5995-00)			
Items 3 & 4 are secured to Item 2 by: #2-56 X 1/2" HWH (Serr) UNS #4HD TR3 BO (Qty. 2) (237-5937-02)							
5	Switch Diode, 1N4001	1	112-5001-00	9	1" I.D. Black Rubber Ring	1	545-5348-05
6	Flipper Bat Bushing	1	545-5594-00	10	Caution Decal: For Proper Operation of...	1	820-6303-00
Item 6 is secured to Item 1 by: #6-32 X 3/8" HWH Swg. (Ser.) Zc. (Qty. 3) (237-5976-02)							

FOR PROPER OPERATION OF DRIVE WHEEL
 REPLACE RUBBER RING WITH SAME SIZE & TYPE (1" INSIDE DIA.)
 ask for SPI PART N°: 545-5348-05

Assoc. Parts: Driven Wheel, Plastics, Mini-Flip. Bat & Shaft & Rubber Ring (Items AP-A - AP-D)

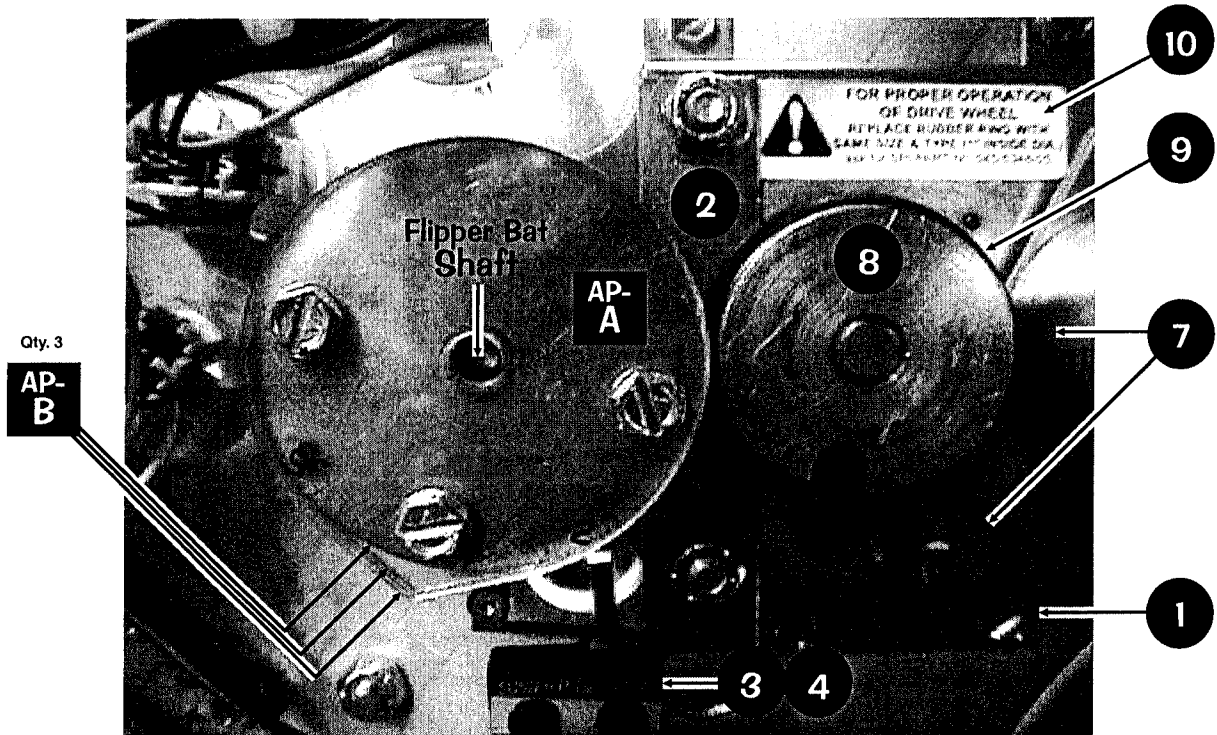

For Securing Hardware, see the Parts Table below under Item desired.

ASSOCIATED PARTS ARE NOT INCLUDED WITH THE ABOVE ASSEMBLY.

Nº	ASSOCIATED PART NAME	QTY.	SPI PART Nº
AP-A	Driven Wheel (smooth edge)	1	530-5599-00
Item A is secured to Item 3 by: #10-32 X 5/16" Set Screw Cup Point (Qty. 1) (237-6092-00)			
AP-B	Clear Plastic (Butyrate) -2	3	830-5987-02
Item B (3 stacked) are secured to the bottom of Item 1 by: #8-32 X 1/2" HWH Swage (Serr) Zinc (Qty. 3) (237-5975-01)			
Special Ordering note on Item B: The individual pieces may not be available in which case the entire sheet must be ordered. See Sec. 4, Chp. 1, Parts Id. & Location, Page 57.			
AP-C	YEL Mini-Flip. Bat & Shaft (Plain) Assy.	1	515-7191-06
AP-D	Small Flipper RED Rubber Ring	1	545-5207-22

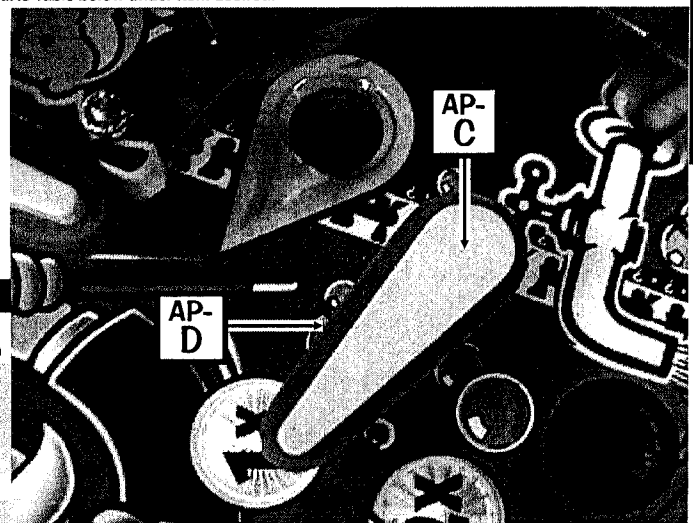

Sec. 4: Drawings ...



Left Plastic Ramp, 515-7221-00 (Item 1) & Individual Parts (Items 2-22)
 Drawing & Parts Table continues on the next page.

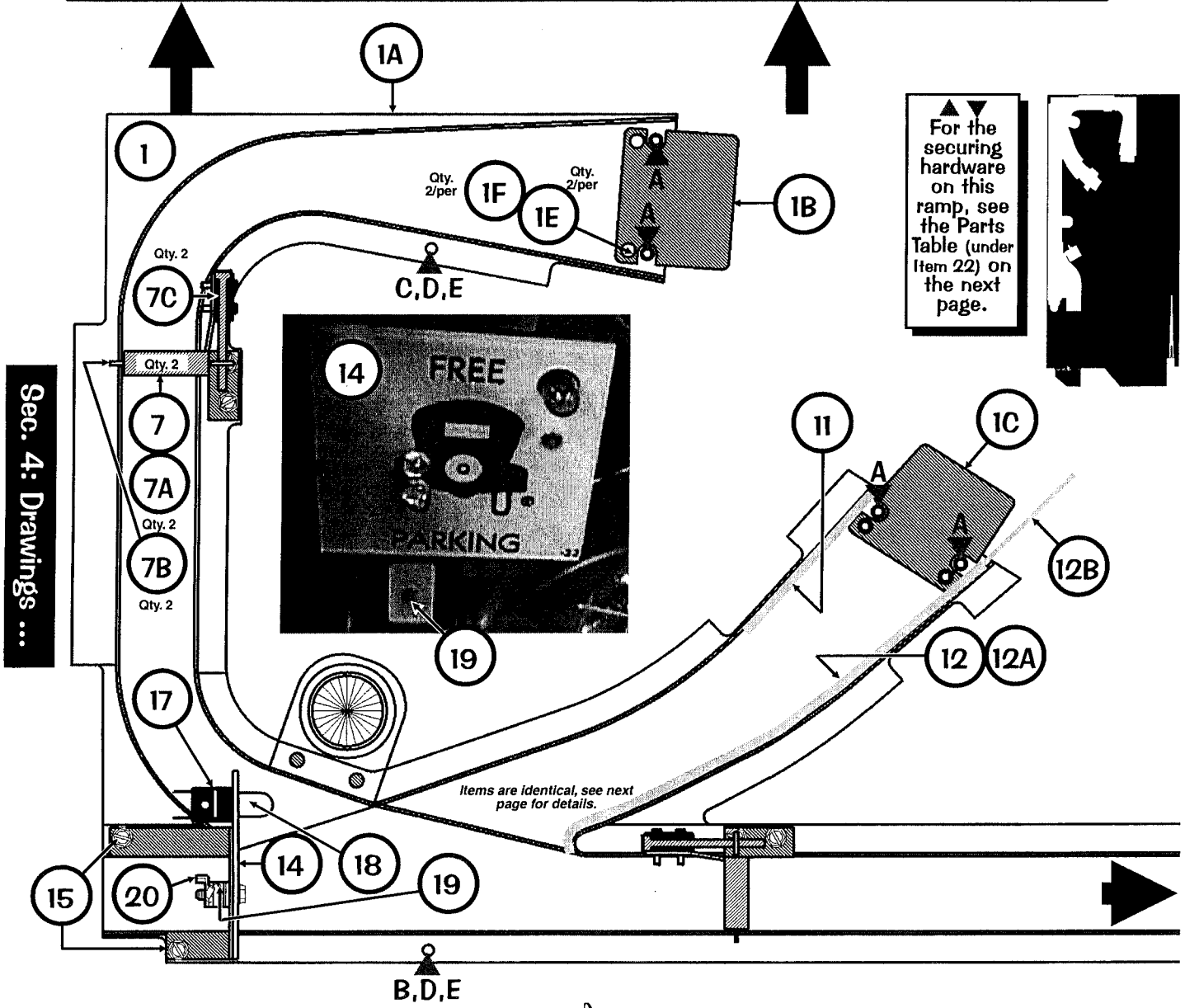
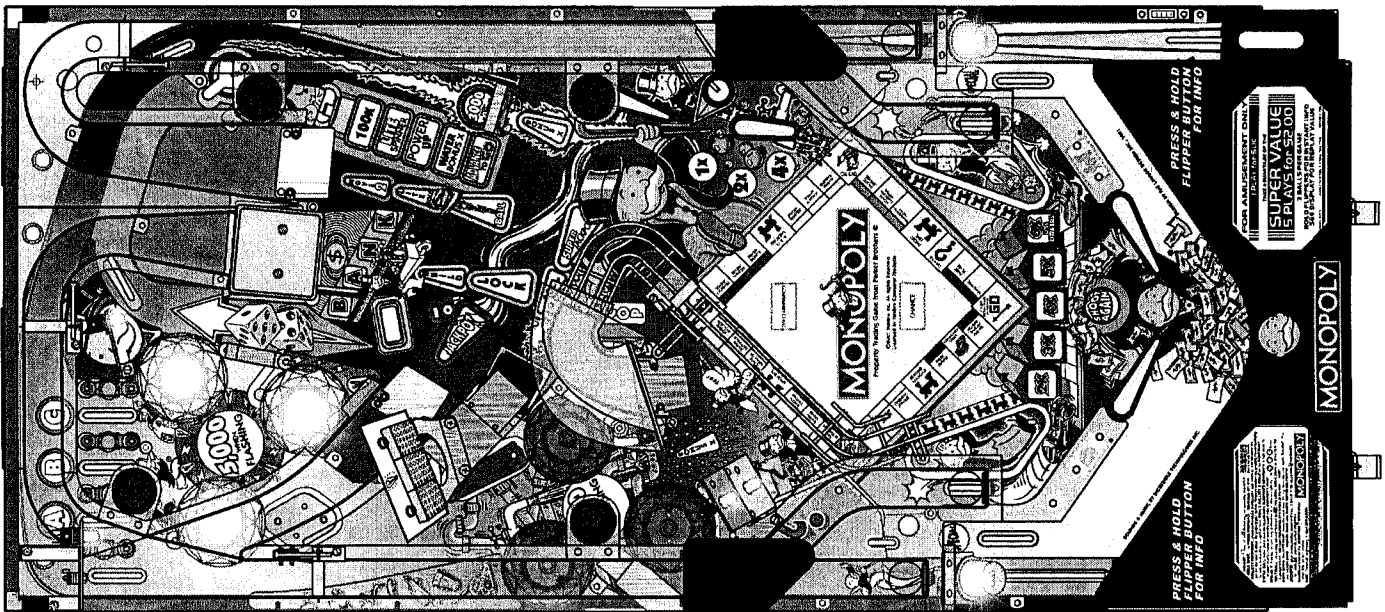

Left Plastic Ramp, 515-7221-00 (Item 1) & Individual Parts (Items 2-22) Continued

Drawing & Parts Table continues on the previous page.

N ^o	INDIVIDUAL PART NAME	QTY.	SPI PART N ^o	N ^o	INDIVIDUAL PART NAME	QTY.	SPI PART N ^o
1 [®]	Left Plastic Ramp Riveted Assembly	1	515-7221-00	12 [®]	Ramp Guard & Flap Assembly	1	515-7209-00
ORDERING ABOVE [®] RIVETED ASSY. PART N ^o WILL INCLUDE:				ORDERING ABOVE [®] RIVETED ASSY. PART N ^o WILL INCLUDE:			
1A [®]	Ramp (Plain No Parts)	1	545-5992-00	12A [®]	Ramp Guard (Long) (Plain No Parts)	1	535-9044-00
1B [®]	Left Ramp Flap (secured to 1A by 1E/F)	1	535-8966-00	12B [®]	Ramp Guard Flap (secured to 12A by 12C)	1	533-9045-00
1C [®]	Center Ramp Flap (secured to 1A by 1E/F)	1	535-8967-00	12C*	Rivet, 1/8" ø X 1/8" Lg. (Nickel)	1	249-5008-00
1D [®]	Clr. Plastic (Buty.) (secured to 1A by 1G/H)	3	830-5987-04	Item 12 is secured to Item 1 by: #6-32 X 3/8" PPH MS (Sems) Zinc (Qty. 2) (232-5201-00) and #6-32 Nylon Stop Nut (Qty. 2) (240-5005-00)			
1E	Rivet, 1/8" ø X 3/16" Lg.	8	249-5001-00	<i>Ordering Note:</i> If 515-7209-00 is unavailable, order the individual part(s) actually required.			
1F	#6 Lock Washer (Riveting)	8	246-5000-00	13 [®]	Screened Plastic (Butyrate) -18	1	830-5985-18
1G	Pop Rivet, 1/8" ø X .39" Lg.	2	249-5018-00	Item 13 is secured to Item 16 by: See securing hardware under Item 17.			
1H	Washer 9/64 I.D. X 5/16" O.D. X 1/32"	2	242-5017-00	14 [®]	Screened Plastic (Butyrate) -22	1	830-5985-22
For how Item 1 is secured to the playfield, see the end of this parts table.				Item 14 is secured to Item 15 by: #6-32 X 3/4" HWH Swage (Serr) Zc (Qty. 2) (237-5976-05)			
<i>Ordering Note:</i> If 515-7221-00 is unavailable, order the individual part(s) actually required.				<i>Special Ordering note on Items 13 & 14:</i> The individual pieces may not be available in which case the entire sheet must be ordered. See Sec. 4, Chp. 1, Parts Id. & Loc., Page 57.			
2	Mounting Bracket (for Diverter)	1	535-8987-00	15 [®]	Bracket (Free Parking), Sign Mounting	1	535-8974-00
Item 2 is secured to Item 1 by: #8-32 X 3/8" HWH MS (Zinc) (Qty. 2) (237-5868-00) and #8-32 Nylon Stop Nut (Qty. 2) (240-5102-00)				16 [®]	Bracket (Collect...), Sign Mounting	1	535-8975-00
3	Ball Diverter (Coil & Lt. Bracket) Assy.	1	515-6595-00	Items 15 & 16 are secured to Item 1 by: #8-32 X 3/8" HWH MS (Zinc) (Qty. 2/per) (237-5868-00) and #8-32 Nylon Stop Nut (Qty. 2/per) (240-5102-00)			
ORDERING ABOVE (ITEM 3) SUB-ASSY. PART N ^o WILL INCLUDE:				17 [®]	#555 Wedge Base Socket (Offset)	3	077-5029-00
3A	Frame	1	535-6198-00	Item 17 is secured to Items 13 & 14 by: Rivet, 1/8" ø X 3/16" Lg. (Nickel) (Qty. 1/per) (249-5001-00) and #6 Riveting Lock Washer (Qty. 1/per) (246-5000-00)			
3B	Coil Arm & Armature (Left Style)	1	515-6594-00	18	#555 Wedge Base Bulb (Yel)	3	165-5054-06
3C	Return Spring (Jaldringer #SPR29-18)	1	265-5024-00	19	Switch & Target Assy. Narrow (Yel)	1	515-5967-06
3D	Coil, 32-1800	1	090-5031-00	20	Bracket, Switch Back Plate	1	535-6452-00
Item 3 is secured to Item 2 by: #8-32 X 3/8" PFH 82 Undercut Zinc (Qty. 1) (237-6030-00)				Items 20 & 21 are secured with the same hardware used to secure Item 14 into Item 15.			
<i>Ordering Note:</i> If 515-6595-00 is unavailable, order the individual part(s) actually required.				21*	Foam Pad (Switch Back) Self-Adh.	1	626-5029-00
4	Diverter Cover (Black Plastic, Left Style)	1	545-5999-00	22*	Insulator (Fische Paper)	1	545-6024-01
Item 4 is secured to Item 2 by: #8-32 X 1/4" HWH Swage (Serr) Zc (Qty. 2) (237-5975-04)				Item 22 is positioned between Items 15 & 19 at mounting point.			
5	#906 IDC Snap-On Socket (no diode)	3	077-5216-01	Left Plastic Ramp is secured above the playfield by:			
6	#906 Wedge Base Bulb (Clear)	3	165-5004-00	AA	#4 X 5/8" PFH (Black)	Qty. 4	237-5833-00
7	Gate (Roll-Under 1-1/2" Gold) Assy.	2	515-6490-06	BA	2 1/4" X 1/4" Hex Spacer #6-32 Tap	Qty. 2	254-5008-32
ORDERING ABOVE (ITEM 7) SUB-ASSY. PART N ^o WILL INCLUDE:				CA	2 5/8" X 1/4" Hex Spacer #6-32 Tap	Qty. 1	254-5008-08
7A	Gate Bracket (Gold)	1	535-8529-00	DA	#6-32 X 3/8" PPH MS (Sems) Zinc	Qty. 3	232-5201-00
7B	Wire Form (Gold) (on above item)	1	535-8530-00	EA	#6 Washer	Qty. 2	242-5001-00
7C	Micro Switch (for Roll-Under Gate)	1	180-5087-00	FA	1.9" X 1/4" Hex Spacer #8-32 Tap	Qty. 1	254-5031-03
7D*	Switch Body Protect Plate	1	535-6539-00	GA	#8-32 X 3/8" PPH MS (Sems) Zinc	Qty. 1	232-5301-00
7E*	Diode, 1N4001	1	112-5001-00	HA	#8 Washer	Qty. 3	242-5005-00
7F*	#2-56 X 1/2" HWH Ser UNS #4HD TR3 BO	2	237-5937-02	This Ramp is secured into the Back Panel by: Back Edge Lip into Back Panel Slot.			
Item 7 is secured to Item 1 by: #6-32 X 3/8" PPH MS (Sems) Zinc (Qty. 2) (232-5201-00) and #6-32 Nylon Stop Nut (Qty. 2) (240-5005-00)				Note: Item B ▲ is mounted on a Ramp Mounting Bracket (515-6508-00) on the wood rail.			
<i>Ordering Note:</i> If 515-6490-06 is unavailable, order the individual part(s) actually required.							
8	Mini-Mars Light Cover (Snap-In) Clear	1	550-5030-01				
9	Mini-Mars Light Cover (Snap-In) Red	2	550-5030-02				
10	Deflector Pad (Rubber Bumper)	2	545-5428-00				
11	Ramp Guard	1	535-9055-00				
Item 11 is secured to Item 1 by: #6-32 X 3/8" PPH MS (Sems) Zinc (Qty. 2) (232-5201-00)							

Take Note:

* An asterisk (*) indicates item(s) are not noted in the pictorials.
[®] "R" indicates Item noted is secured with rivet(s) as listed.

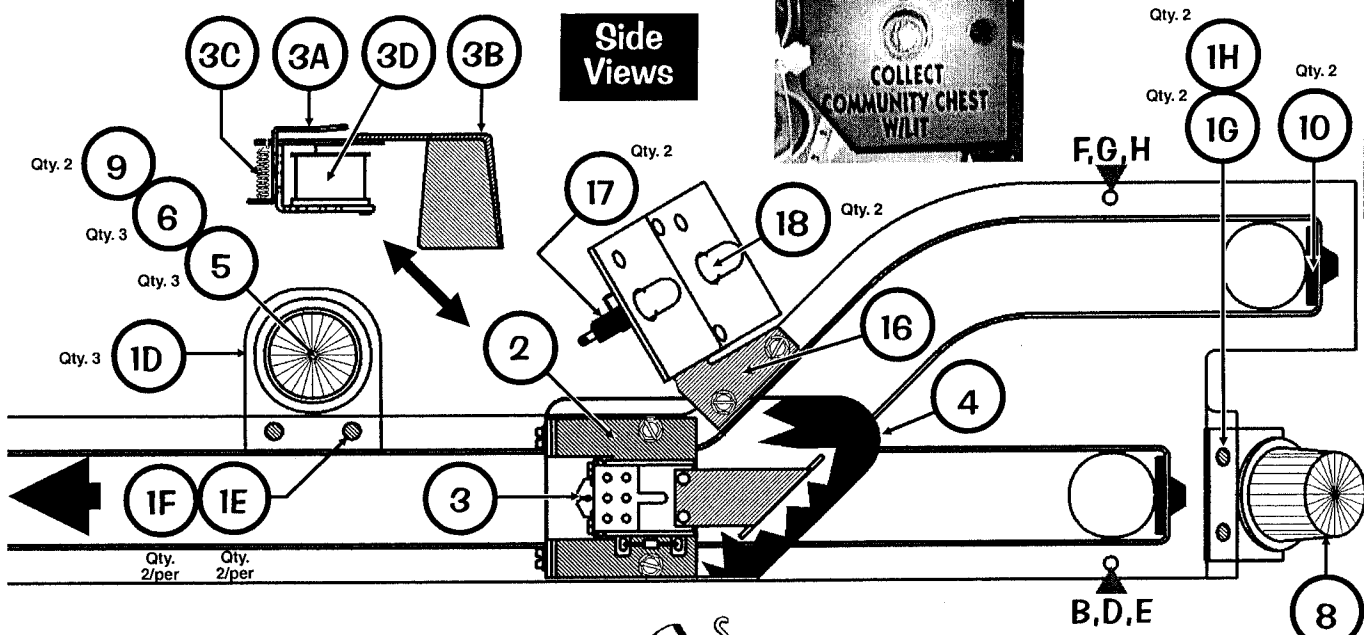

Right Plastic Ramp, 515-7220-00 (Item 1) & Individual Parts (Items 2-11)
 Parts Tables on the next page.

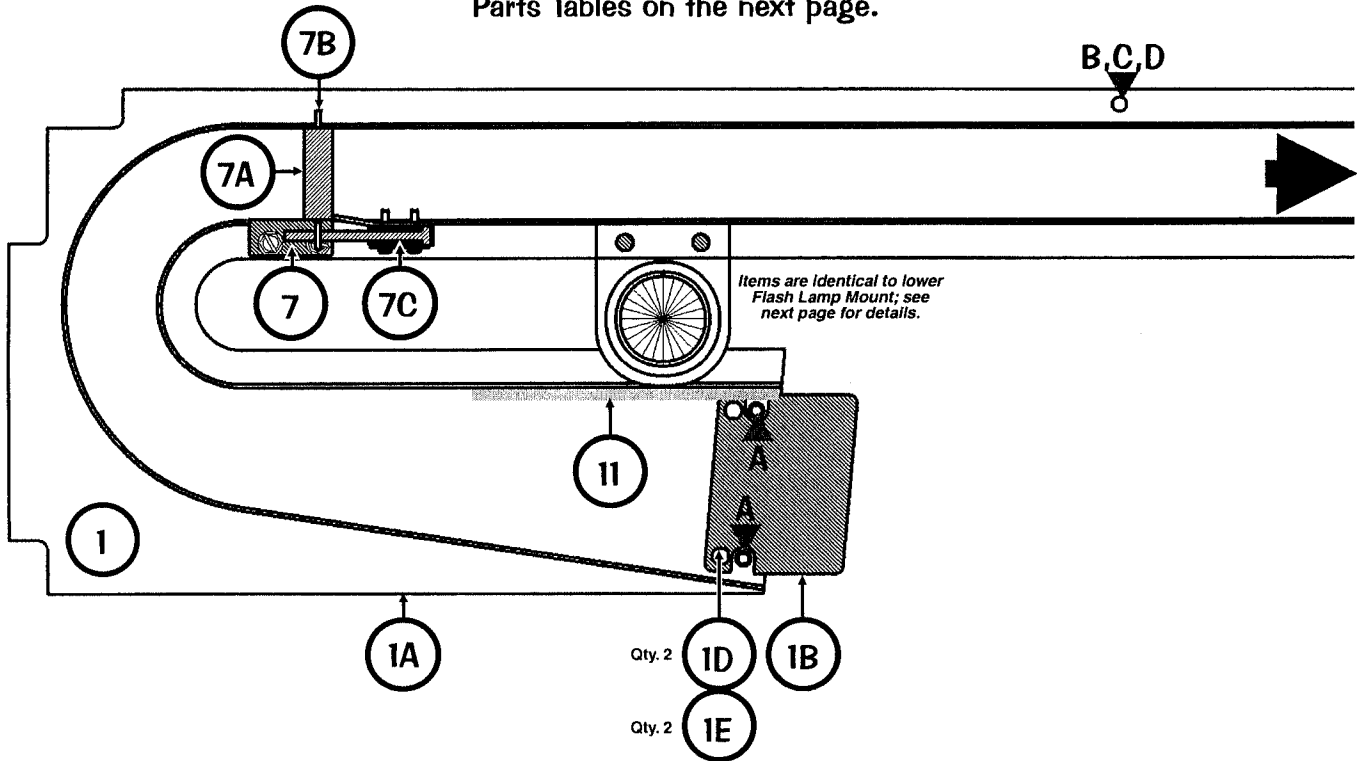

▲▼
 For the securing hardware on this ramp, see the Parts Table (under Item 11) on the next page.

Sec. 4: Drawings ...

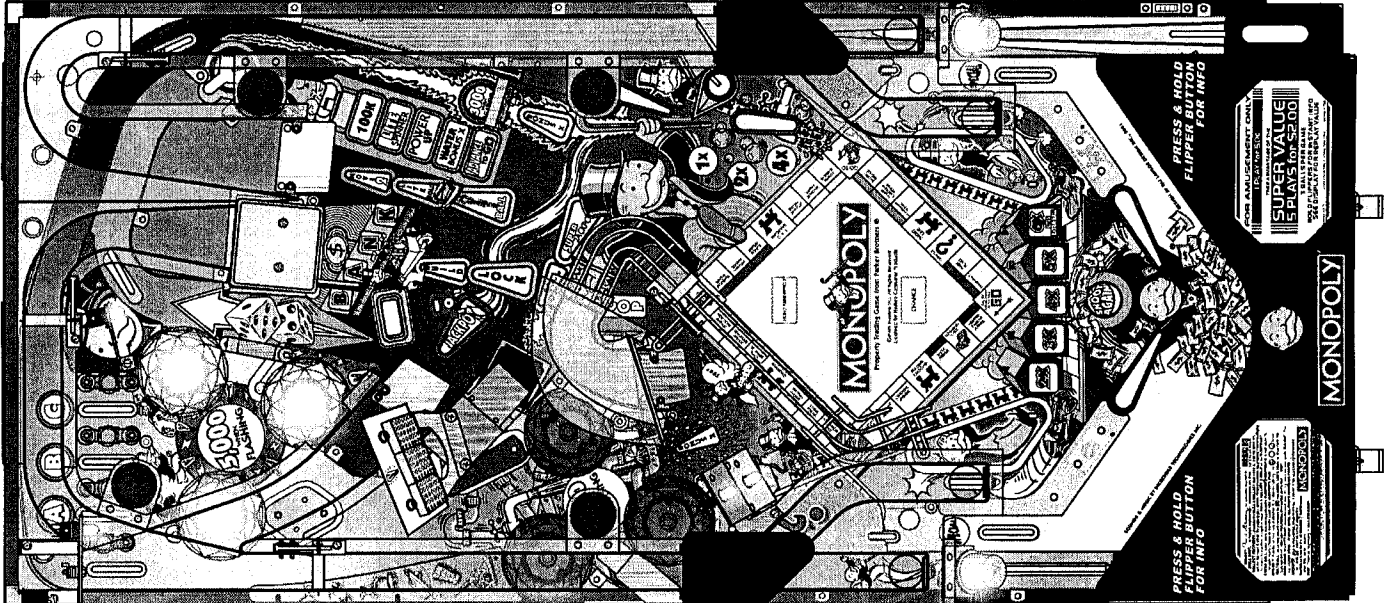

Right Plastic Ramp, 515-7220-00 (Item 1) & Individual Parts (Items 2-11) Continued
 Drawings continues on the previous page.

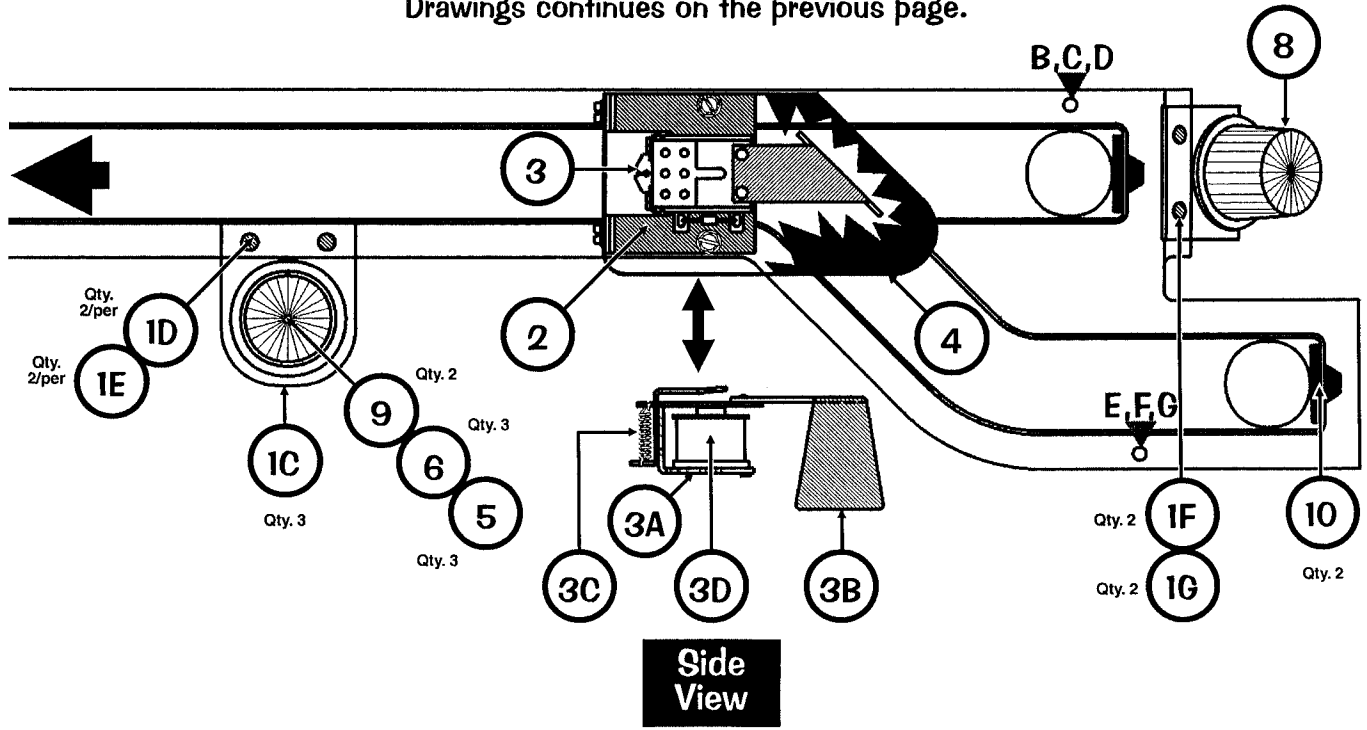

Take Note:

- * An asterisk (*) indicates item(s) are not noted in the pictorials.
- Ⓜ "R" indicates Item noted is secured with rivet(s) as listed.

Nº	INDIVIDUAL PART NAME	QTY.	SPI PART Nº	Nº	INDIVIDUAL PART NAME	QTY.	SPI PART Nº
1Ⓜ	Right Plastic Ramp Riveted Assembly	1	515-7220-00	7	Gate (Roll-Under 1-1/2" Gold) Assy.	1	515-6490-06
ORDERING ABOVEⓂ RIVETED ASSY. PART Nº WILL INCLUDE:				ORDERING ABOVE (ITEM 7) SUB-ASSY. PART Nº WILL INCLUDE:			
1AⓂ	Ramp (Plain No Parts)	1	545-5993-00	7A	Gate Bracket (Gold)	1	535-8529-00
1BⓂ	Ramp Flap (secured to 1A by 1D/F)	1	535-8968-00	7B	Wire Form (Gold) (on above item)	1	535-8530-00
1CⓂ	Cir. Plastic (Buty.) (secured to 1A by 1E/G)	3	830-5987-04	7C	Micro Switch (for Roll-Under Gate)	1	180-5087-00
1D	Rivet, 1/8" ø X 3/16" Lg.	6	249-5001-00	7D*	Switch Body Protect Plate	1	535-6539-00
1E	#6 Lock Washer (Riveting)	6	246-5000-00	7E*	Diode, 1N4001	1	112-5001-00
1F	Pop Rivet, 1/8" ø X .39" Lg.	2	249-5018-00	7F*	#2-56 X 1/2" HWH Ser UNS #4HD TR3 BO	2	237-5937-02
1G	Washer 9/64 I.D. X 5/16" O.D. X 1/32"	2	242-5017-00	Item 7 is secured to Item 1 by: #6-32 X 3/8" PPH MS (Sems) Zinc (Qty. 2) (232-5201-00) and #6-32 Nylon Stop Nut (Qty. 2) (240-5005-00)			
For how Item 1 is secured to the playfield, see the end of this parts table.				Ordering Note: If 515-6490-06 is unavailable, order the individual part(s) actually required.			
2	Mounting Bracket (for Diverter)	1	535-8987-00	8	Mini-Mars Light Cover (Snap-In) Clear	1	550-5030-01
Item 2 is secured to Item 1 by: #8-32 X 3/8" HWH MS (Zinc) (Qty. 2) (237-5868-00) and #8-32 Nylon Stop Nut (Qty. 2) (240-5102-00)				9	Mini-Mars Light Cover (Snap-In) Red	2	550-5030-02
3	Ball Diverter (Coil & Rt. Bracket) Assy.	1	515-6595-01	10	Deflector Pad (Rubber Bumper)	2	545-5428-00
ORDERING ABOVE (ITEM 3) SUB-ASSY. PART Nº WILL INCLUDE:				11	Ramp Guard	1	535-9054-00
3A	Frame	1	535-6198-00	Item 11 is secured to Item 1 by: #6-32 X 3/8 PPH MS (Sems) Zinc (Qty. 2) (232-5201-00)			
3B	Coil Arm & Armature (Right Style)	1	515-6594-01	Right Plastic Ramp is secured above the playfield by:			
3C	Return Spring (Jaidninger #SPR29-18)	1	265-5024-00	A▲▼	#4 X 5/8" PFH (Black)	Qty. 2	237-5833-00
3D	Coil, 32-1800	1	090-5031-00	B▼	2 1/4" X 1/4" Hex Spacer #6-32 Tap	Qty. 2	254-5008-18
Item 3 is secured to Item 2 by: #8-32 X 3/8" PFH 82 Undercut Zinc (Qty. 1) (237-6030-00)				C▼	#6-32 X 3/8" PPH MS (Sems) Zinc	Qty. 2	232-5201-00
Ordering Note: If 515-6595-01 is unavailable, order the individual part(s) actually required.				D▼	#6 Washer	Qty. 2	242-5001-00
4	Diverter Cover (Black Plastic, Rt. Style)	1	545-6000-00	E▼	2" X 1/4" Hex Spacer #8-32 Tap	Qty. 1	254-5031-04
Item 4 is secured to Item 2 by: #8-32 X 1/4" HWH Swage (Serr) Zc. (Qty. 2) (237-5975-04)				F▼	#8-32 X 3/8" PPH MS (Sems) Zinc	Qty. 1	232-5301-00
5	#906 IDC Snap-On Socket (no diode)	3	077-5216-01	G▼	#8 Washer	Qty. 2	242-5005-00
6	#906 Wedge Base Bulb (Clear)	3	165-5004-00	This Ramp is secured into the Back Panel by: Back Edge Lip into Back Panel Slot.			
				Note: Item B ▼ is mounted on a Ramp Mounting Bracket (515-6508-00) on the wood rail.			



Metal Ramp, 500-6510-00 (Item 1), Wire Ramp, 535-8917-00 (Item 11)

& Individual Parts
(Items 3-10 & 12)

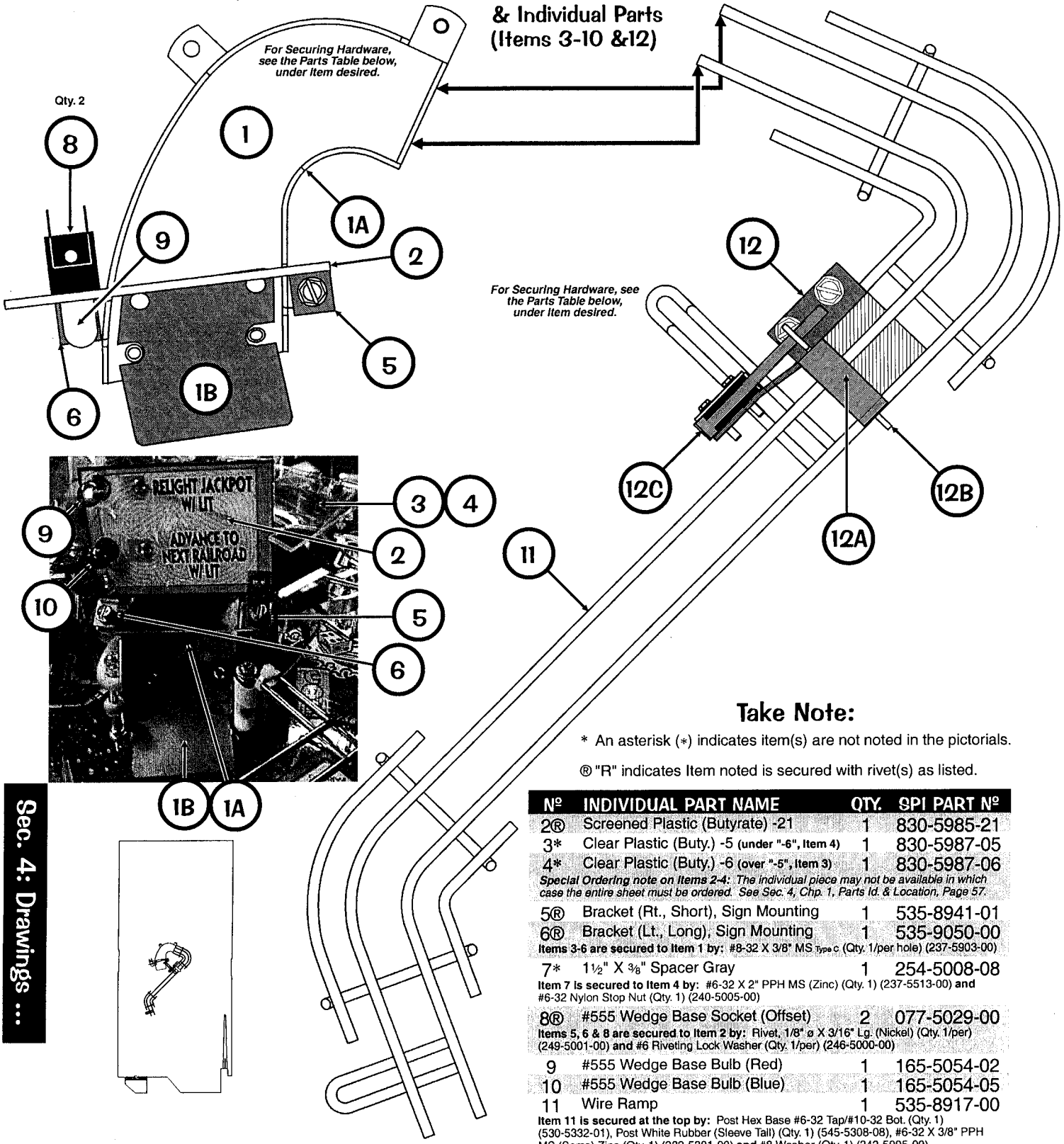

Sec. 4: Drawings ...

For Securing Hardware, see the Parts Table below, under Item desired.

Take Note:

* An asterisk (*) indicates item(s) are not noted in the pictorials.

® "R" indicates Item noted is secured with rivet(s) as listed.

Nº	INDIVIDUAL PART NAME	QTY.	SPI PART Nº
2®	Screened Plastic (Butyrate) -21	1	830-5985-21
3*	Clear Plastic (Buty.) -5 (under "-6", Item 4)	1	830-5987-05
4*	Clear Plastic (Buty.) -6 (over "-5", Item 3)	1	830-5987-06
<i>Special Ordering note on Items 2-4: The individual piece may not be available in which case the entire sheet must be ordered. See Sec. 4, Chp. 1, Parts Id. & Location, Page 57.</i>			
5®	Bracket (Rt., Short), Sign Mounting	1	535-8941-01
6®	Bracket (Lt., Long), Sign Mounting	1	535-9050-00
Items 3-6 are secured to Item 1 by: #8-32 X 3/8" MS Type C (Qty. 1/per hole) (237-5903-00)			
7*	1 1/2" X 3/8" Spacer Gray	1	254-5008-08
Item 7 is secured to Item 4 by: #6-32 X 2" PPH MS (Zinc) (Qty. 1) (237-5513-00) and #6-32 Nylon Stop Nut (Qty. 1) (240-5005-00)			
8®	#555 Wedge Base Socket (Offset)	2	077-5029-00
Items 5, 6 & 8 are secured to Item 2 by: Rivet, 1/8" ø X 3/16" Lg. (Nickel) (Qty. 1/per) (249-5001-00) and #6 Riveting Lock Washer (Qty. 1/per) (246-5000-00)			
9	#555 Wedge Base Bulb (Red)	1	165-5054-02
10	#555 Wedge Base Bulb (Blue)	1	165-5054-05
11	Wire Ramp	1	535-8917-00
Item 11 is secured at the top by: Post Hex Base #6-32 Tap/#10-32 Bot. (Qty. 1) (530-5332-01), Post White Rubber (Sleeve Tall) (Qty. 1) (545-5308-08), #6-32 X 3/8" PPH MS (Sems) Zinc (Qty. 1) (232-5201-00) and #8 Washer (Qty. 1) (242-5005-00)			
12	Gate (Roll-Under 1-1/2" Gold) Assy.	1	515-6490-06
ORDERING ABOVE (ITEM 12) SUB-ASSY. PART Nº WILL INCLUDE:			
12A	Gate Bracket (Gold)	1	535-8529-00
12B	Wire Form (Gold) (on above item)	1	535-8530-00
12C	Micro Switch (for Roll-Under Gate)	1	180-5087-00
12D*	Switch Body Protect Plate	1	535-6539-00
12E*	Diode, 1N4001	1	112-5001-00
12F*	#2-56 X 1/2" HWH Ser UNS #4HD TR3 BO	2	237-5937-02
Item 12 is secured to Item 11 by: #6-32 X 1/4" PPH MS (Sems) Zinc (Qty. 2) (232-5200-00)			
<i>Ordering Note: If 515-6490-06 is unavailable, order the individual part(s) actually required.</i>			

Nº	INDIVIDUAL PART NAME	QTY.	SPI PART Nº
1®	Metal Ramp Riveted Assembly	1	500-6510-00
ORDERING ABOVE® RIVETED ASSY. PART Nº WILL INCLUDE:			
1A®	Ramp (Plain No Parts)	1	535-8922-00
1B®	Ramp Flap (secured to 1A by 1C)	1	535-8969-00
1C*	Rivet, 1/8" ø X 1/8" Lg. (Nickel)	2	249-5008-00
Item 1 is secured above the playfield at Ramp Tab by: #8 X 1/2" HWH AB Zinc (Qty. 1) (234-5101-00) and at Ramp Flap by: #4 X 5/8" PPH (Black) (Qty. 2) (237-5833-00)			
<i>Ordering Note: If 500-6510-00 is unavailable, order the individual part(s) actually required.</i>			



Speed Bump Ramp, 515-7202-00 (Item 1) & Individual Parts (Items 2-5)

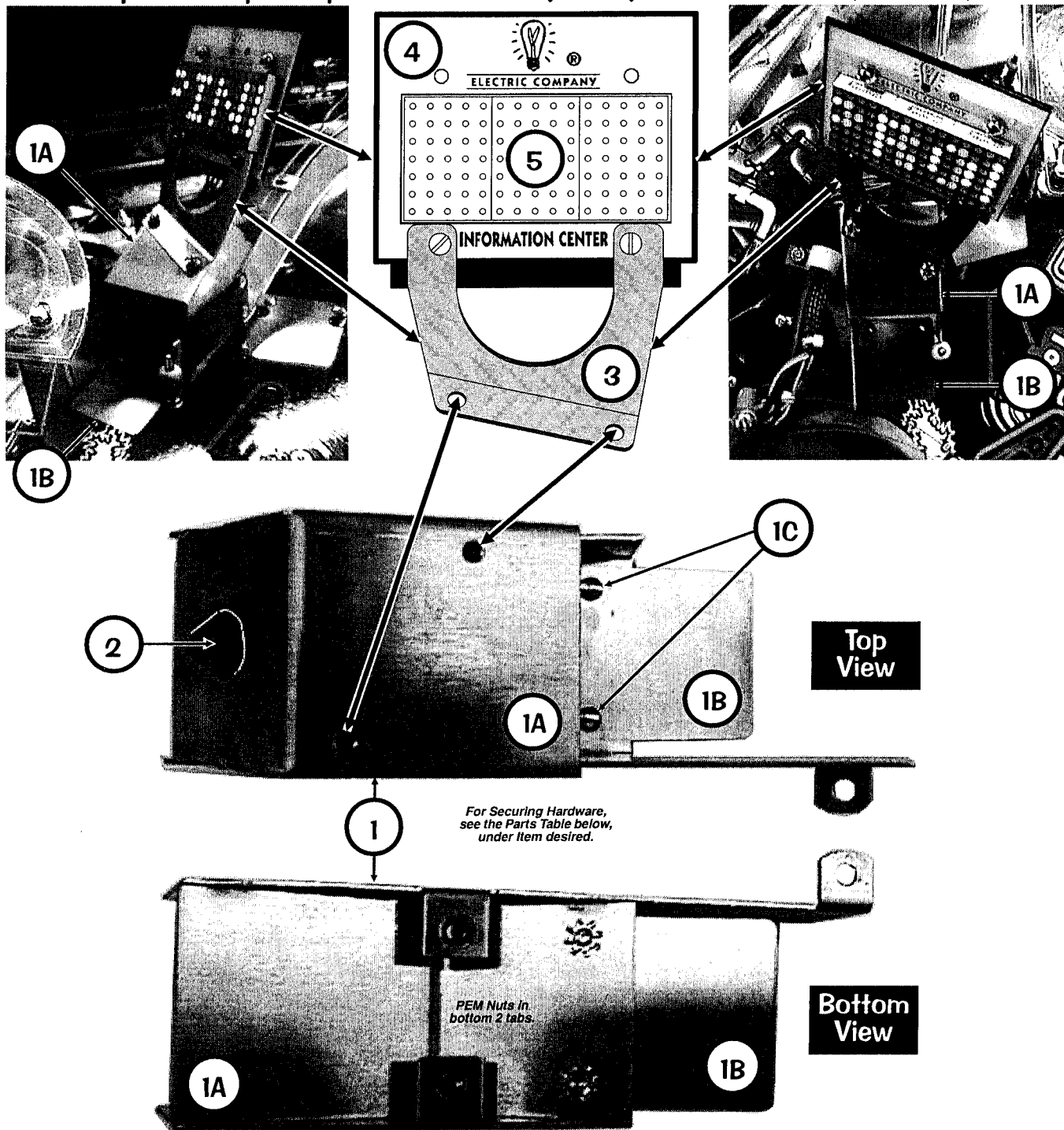

Take Note:

® "R" indicates Item noted is secured with rivet(s) as listed.

For a break-down of parts of Item 5, Dot Display Board (520-5197-00), see Sec. 5, Chp. 4, Dot Display (5X7) x3 PC Board (Electric Company Sign) Component Layout & Parts, Page 133.

Nº	INDIVIDUAL PART NAME	QTY.	SPI PART Nº	Nº	INDIVIDUAL PART NAME	QTY.	SPI PART Nº
1®	Speed Bump Metal Ramp Riv. Assy.	1	515-7202-00	3	Mounting Bracket (Dot Matrix Sign)	1	535-8946-00
ORDERING ABOVE® RIVETED ASSY. PART Nº WILL INCLUDE:				Item 3 is secured to Item 1 by: #8-32 X 1/4" MS (Sems) Zinc (Qty. 2) (232-5300-00)			
1A®	Speed Bump Ramp (Plain No Parts)	1	535-9034-00	4	Screened Plastic (Butyrate) -19	1	830-5985-19
1B®	Ramp Flap (secured to 1A by 1C)	1	535-9037-00	<i>Special Ordering note on Item 4: The individual piece may not be available in which case the entire sheet must be ordered. See Sec. 4, Chp. 1, Parts Id. & Location, Page 57.</i>			
1C	Rivet, 1/8" Ø X 1/8" Lg. (Nicke)	2	249-5008-00	5	Dot Display (5X7) x3 PC Board	1	520-5197-00
Item 1 is secured above the playfield at Ramp Tab by: #8 X 1/2" HWH AB Zinc (Qty. 1) (234-5101-00) and below the playfield by: #8-32 X 7/8" HWH MS (Zinc) (Qty. 2) (237-5690-00) and #8 Washer, 17" I.D. X 1/2" O.D. X .042" (Qty. 2) (242-5015-00)				Items 4 & 5 are secured to Item 3 by: #4-40 X 1/2" PPH MS (Sems) Zinc (Qty. 4) (237-5813-00), #4-40 Nylon Stop Nut (Qty. 4) (240-5303-00), #4 Washer Nylon (Qty. 4 @ rear) (242-5068-00) and #4 Washer (Qty. 2 @ Item 3 Top) (242-5002-00)			
<i>Ordering Note: If 515-7202-00 is unavailable, order the individual part(s) actually required.</i>							
2	Deflector Pad (Bumper)	1	545-5428-00				

UK ONLY OPTIONAL
Ball Deflector Assemblies, 500-5788-02 (Qty. 2) (Items 1-8)

Nº	INDIVIDUAL PART NAME	QTY.	SPI PART Nº
1	Ball Deflector Coil Mounting Bracket	1	535-6857-02
Item 1 is secured below the playfield by: #8 X 1/2" HWH AB (Zinc) (Qty. 4) (234-5101-00)			
2	Coil Retaining Bracket	1	535-5203-03
Item 2 is secured by: #8-32 X 1/4" PPH MS (Sems) Zinc (Qty. 2) (232-5300-00)			
3	Coil, 26-1200	1	090-5044-00T
ORDERING ABOVE (ITEM 3) COIL PART Nº WILL INCLUDE:			
— Diode, 1N4004 (positioned at top) 1 112-5003-00			
4	Coil Sleeve (Short) (Formost #10-7077)	1	545-5076-01
5	Spring Washer (17/32" ID X 3/4" X 1")	1	269-5002-00
6	Solid Plunger Assembly	1	515-6858-00
7	Compression (Relay) Spring	1	266-5022-01
8	#10-32 Adj. Spindle Stop w/Rubber Tip	1	280-5014-00
Item 8 is secured by: #10-32 Keps Nut (Qty. 1) (240-5208-00)			

Ordering Note: If 500-5788-02 is unavailable, order the individual part(s) actually required.

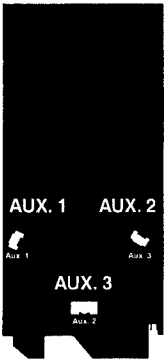
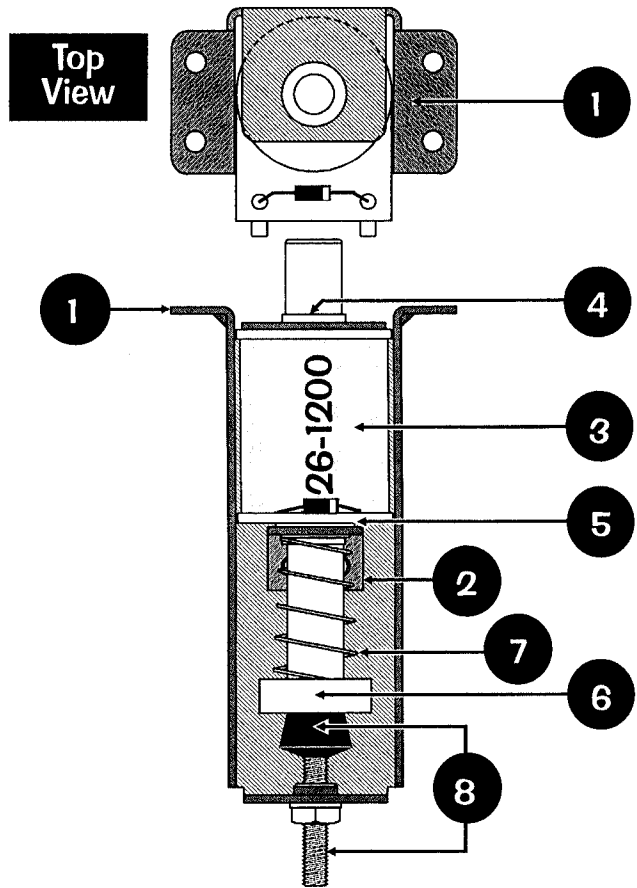

UK ONLY OPTIONAL
Up/Down Post Assembly, 500-6293-00 (Items 1-9)

Nº	INDIVIDUAL PART NAME	QTY.	SPI PART Nº
1	Up/Down Post Coil Mounting Bracket	1	515-6840-00
Item 1 is secured below the playfield by: #8 X 1/2" HWH AB (Zinc) (Qty. 6) (234-5101-00)			
2	Adjustment Spindle Stop Bracket	1	535-8303-00
3	Coil Retaining Bracket	2	535-7356-00
Items 2 & 3 are secured by: #8-32 X 3/8" Swage (Serr) Zinc (Qty. 2/per) (237-5975-00)			
4	Coil, 23-1100 (ORG)	1	090-5030-00T
ORDERING ABOVE (ITEM 4) COIL PART Nº WILL INCLUDE:			
— Diode, 1N4004 (positioned at top) 1 112-5003-00			
5	Coil Sleeve (with extension)	1	545-5847-00
6	Spring Washer, 17/32" ID X 3/4" X 1"	1	269-5002-00
7	Plunger & Shaft Assembly	1	515-6844-00
ORDERING ABOVE (ITEM 7) SUB-ASSY. PART Nº WILL INCLUDE:			
7A	Ball Bumper Plastic (Top) Red	1	550-5029-02
7B*	Roll Pin, 3/32" ø X 1/2" Long	1	251-5002-00
7C*	Retaining Ring, 1/4" ø Shaft	1	270-5002-00
7D	Plunger & Shaft Sub-Assembly	1	515-6841-00
7E	Plunger Head	1	530-5511-00
7F	#10-32 X 3/8" PPH MS (Sems) Zinc	1	232-5401-00

Ordering Note: If 515-6844-00 is unavailable, order the individual part(s) actually required. Item 7D, part of item 7, Plunger & Shaft Sub-Assembly, is 1 piece and cannot be ordered separated.

8	Compression (Relay) Spring	1	266-5022-01
9	#10-32 Adj. Spindle Stop w/Rubber Tip	1	280-5014-00
Item 9 is secured by: #10-32 Keps Nut (Qty. 1) (240-5208-00)			

Ordering Note: If 500-6293-00 is unavailable, order the individual part(s) actually required.

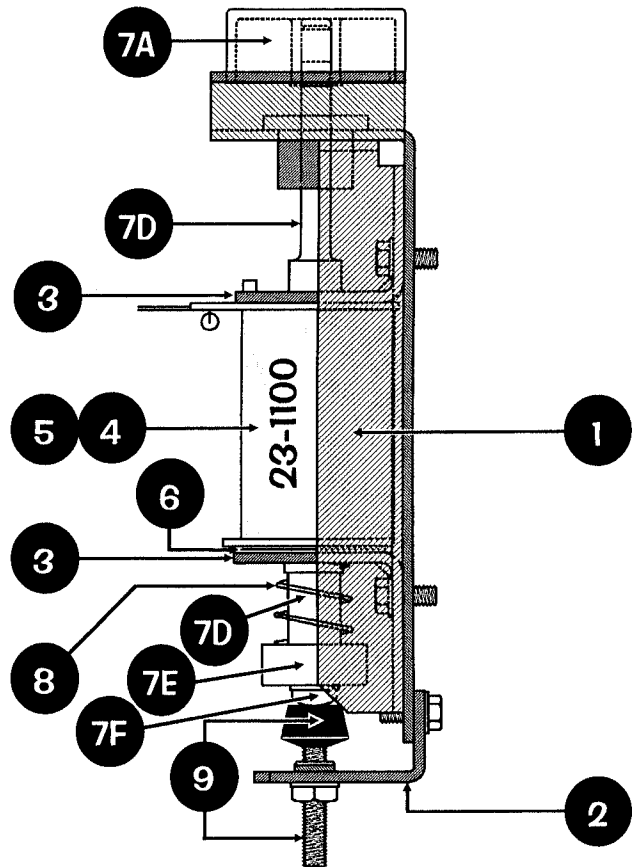

Take Note:

* An asterisk (*) indicates item(s) are not noted in the pictorials.



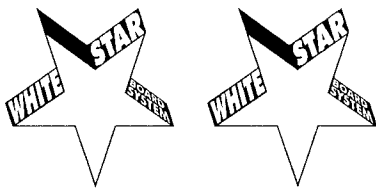

Section 5 Schematics & Troubleshooting Table of Contents

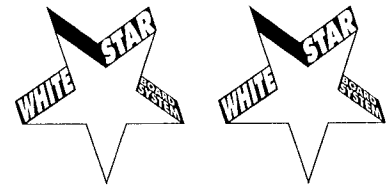

- COILS DETAILED CHART TABLE 90
- Chapter 1, Backbox Wiring 91
 - Backbox I/O Power Driver Board Detailed Wiring Diagram 91
 - Backbox Board Layout Wiring Diagram 92
- Chapter 2, Playfield Wiring..... 93
 - General Illumination Circuit Detailed Wiring Diagram 93
 - Playfield Switch Wiring Diagram & Playfield Lamp Wiring Diagram 94
 - Playfield Terminal Strips, Fuses & Misc. Wiring Descriptions & Locations 95
 - 3-Flipper Circuit Wiring Diagram 96
- Chapter 3, Cabinet Wiring 97
 - Transformer Power Wiring Diagram 97
 - Cabinet / Coin Door Wiring Diagram 98
- Chapter 4, Printed Circuit Boards (PCBs) 99
 - Trough Up-Kicker Dual OPTO Boards
Theory of Operation & Schematic, Component Layout & Parts 99
 - OPTO Troubleshooting (Top) 100
 - Trough Dual OPTO Boards Alignment / Tests for LED1 & LED2 100-101
 - Dot Matrix Display/Display Controller Bd. Combined Display Connections 102
 - Display Power Supply Board Schematic, Component Layout & Parts 103
 - Display Controller Board Schematic 104-105
 - Display Controller Board Component Layout & Parts 106
 - I/O Power Driver Board Theory of Operation 107
 - I/O Power Driver Board Schematic
(Sheet 1 of 5), (Sheet 2 of 5), (Sheet 3 of 5), (Sheet 4 of 5), (Sheet 5 of 5) 108-117
 - I/O Power Driver Board Component Layout 118
 - I/O Power Driver Board Parts 119
 - CPU/Sound Board Theory of Operation 121
 - CPU/Sound Board Schematic
(Sheet 1 of 3), (Sheet 2 of 3), (Sheet 3 of 3) 122-127
 - CPU/Sound Board Component Layout 128
 - CPU/Sound Board Parts 129
 - 4-Position OPTO (Trans. & Rec.) PC Boards
Theory of Operation & Schematic 130
 - 4-Position OPTO (Trans. & Rec.) PC Boards
Component Layout & Parts 131
 - Dot Display (5X7) x3 PC Board (Electric Company Sign)
Schematic 132
 - Dot Display (5X7) x3 PC Board (Electric Company Sign)
Component Layout & Parts 133
 - (UK Only) Solenoid Expander PC Board
Schematic, Component Layout & Parts 134

Visit www.StemPinball.com/schematics.htm for the latest 11" X 17" Schematics (or "Split 8-1/2" X 11" for the Display Power Supply, Display Controller, I/O Power Driver & CPU/Sound Boards (White Star's System Only). Along with the schematics you'll find the component diagrams and their locations. The files are in PDF format (Adobe Reader required). They may be slow to open in the website only, but once on your harddrive they'll open fast. Inside the schematics you can utilize internal links where addresses may direct you to another sheet in the schematic set (further instructions within documents). To "download" once open, in your browser click "File" "Save" "Page by eMail". It will be sent to your eMail Address, where there you can save the file to your hardrive.



Use the below **Coils Detailed Chart Table** in conjunction with Sec. 5, Chp. 1, Backbox I/O Power Driver Board Detailed Wiring Diagram (I/O Board Connectors J6, J7, J8 & J9) and Backbox Board Layout Wiring Diagram:

COILS DETAILED CHART TABLE

High Current Coils Group 1		Drive Transistor (D.T.)	Driver Output Board	D.T. Control Line Color	D.T. Control Line Connect	Power Line Color	Power Line Connection	Power Voltage	Coil (GA-Turn) or Bulb Part #
#1	TROUGH UP-KICKER	Q1	I/O Pwr. Drvr.	BRN-BLK	J8-P1	YEL-VIO	J10-P4/5	50v DC	26-1200 090-5044-00T
#2	AUTO LAUNCH	Q2	I/O Pwr. Drvr.	BRN-RED	J8-P3	YEL-VIO	J10-P4/5	50v DC	23-700 090-5022-00T
#3	LOWER LEFT POP	Q3	I/O Pwr. Drvr.	BRN-ORG	J8-P4	YEL-VIO	J10-P4/5	50v DC	26-1200 090-5044-00T
#4	LOWER RIGHT POP	Q4	I/O Pwr. Drvr.	BRN-YEL	J8-P5	YEL-VIO	J10-P4/5	50v DC	26-1200 090-5044-00T
#5	LOWER BOTTOM POP	Q5	I/O Pwr. Drvr.	BRN-GRN	J8-P6	YEL-VIO	J10-P4/5	50v DC	26-1200 090-5044-00T
#6	BANK CLOSE	Q6	I/O Pwr. Drvr.	BRN-BLU	J8-P7	YEL-VIO	J10-P4/5	50v DC	23-1100 090-5030-00T
#7	DROP TARGET RESET	Q7	I/O Pwr. Drvr.	BRN-VIO	J8-P8	YEL-VIO	J10-P4/5	50v DC	24-940 090-5036-00B
#8	LOCK KICKER	Q8	I/O Pwr. Drvr.	BRN-GRY	J8-P9	YEL-VIO	J10-P4/5	50v DC	23-800 090-5001-00B

High Current Coils Group 2		Drive Transistor (D.T.)	Driver Output Board	D.T. Control Line Color	D.T. Control Line Connect	Power Line Color	Power Line Connection	Power Voltage	Coil (GA-Turn) or Bulb Part #
#9	UPPER LEFT POP	Q9	I/O Pwr. Drvr.	BLU-BRN	J9-P1	YEL-VIO	J10-P4/5	50v DC	26-1200 090-5044-00T
#10	UPPER RIGHT POP	Q10	I/O Pwr. Drvr.	BLU-RED	J9-P2	YEL-VIO	J10-P4/5	50v DC	26-1200 090-5044-00T
#11	UPPER BOTTOM POP	Q11	I/O Pwr. Drvr.	BLU-ORG	J9-P4	YEL-VIO	J10-P4/5	50v DC	26-1200 090-5044-00T
#12	CHANCE SCOOP	Q12	I/O Pwr. Drvr.	BLU-YEL	J9-P5	YEL-VIO	J10-P4/5	50v DC	23-800 090-5001-00B
#13	BANK OPEN	Q13	I/O Pwr. Drvr.	BLU-GRN	J9-P6	YEL-VIO	J10-P4/5	50v DC	23-1100 090-5030-00T
#14	UPPER FLIPPER (50v RED/YEL)	Q14	I/O Pwr. Drvr.	BLU-BLK	J9-P7	RED-YEL GRY-YEL	J10-P1/2	50v DC	23-1500 090-5062-00
#15	LEFT FLIPPER (50v RED/YEL)	Q15	I/O Pwr. Drvr.	ORG-GRY	J9-P8	RED-YEL GRY-YEL	J10-P1/2	50v DC	22-1080 090-5032-00T
#16	RIGHT FLIPPER (50v RED/YEL)	Q16	I/O Pwr. Drvr.	ORG-VIO	J9-P9	RED-YEL BLU-YEL	J10-P1/2	50v DC	22-1080 090-5032-00T

Low Current Coils Group 1		Drive Transistor (D.T.)	Driver Output Board	D.T. Control Line Color	D.T. Control Line Connect	Power Line Color	Power Line Connection	Power Voltage	Coil, Bulb or Meter Part #
#17	LEFT SLINGSHOT	Q17	I/O Pwr. Drvr.	VIO-BRN	J7-P2	BRN	J7-P1	20v DC	23-800 090-5001-00T
#18	RIGHT SLINGSHOT	Q18	I/O Pwr. Drvr.	VIO-RED	J7-P3	BRN	J7-P1	20v DC	23-800 090-5001-00T
#19	FLASH RGT RAMP TOP	Q19	I/O Pwr. Drvr.	VIO-ORG	J7-P4	ORG	J6-P10	20v DC	#906 Bulb 165-5004-00
#20	FLASH RGT RAMP MID (X2)	Q20	I/O Pwr. Drvr.	VIO-YEL	J7-P6	ORG	J6-P10	20v DC	#906 Bulb are ABOVE
#21	FLASH LEFT RAMP TOP (X2)	Q21	I/O Pwr. Drvr.	VIO-GRN	J7-P7	ORG	J6-P10	20v DC	#89 Bulb 165-5000-89
#22	FLASH LEFT RAMP MID (X2)	Q22	I/O Pwr. Drvr.	VIO-BLU	J7-P8	ORG	J6-P10	20v DC	#89 Bulb are BELOW
#23	FLASH LEFT RAMP BOT	Q23	I/O Pwr. Drvr.	VIO-BLK	J7-P9	ORG	J6-P10	20v DC	#906 Bulb 165-5004-00
#24	OPTIONAL COIN METER	Q24	I/O Pwr. Drvr.	VIO-GRY	J7-P10	RED	J16-P7	5v DC	Meter 5v 091-5000-00

Diode On Terminal Strip (if noted)

Low Current Coils Group 2		Drive Transistor (D.T.)	Driver Output Board	D.T. Control Line Color	D.T. Control Line Connect	Power Line Color	Power Line Connection	Power Voltage	Coil (GA-Turn) or Bulb Part #
#25	WATERWORKS MOTOR	Q25	I/O Pwr. Drvr.	BLK-BRN	J6-P1	BRN	J7-P1	20v DC	EX00159A 041-5083-00
#26	ELECTRIC COMPANY	Q26	I/O Pwr. Drvr.	BLK-RED	J6-P2	BRN	J7-P1	20v DC	23-800 090-5001-00T
#27	MOTOR RELAY	Q27	I/O Pwr. Drvr.	BLK-ORG	J6-P3	BRN	J7-P1	20v DC	DC Relay 520-5066-00
#28	DICE EJECT	Q28	I/O Pwr. Drvr.	BLK-YEL	J6-P4	BRN	J7-P1	20v DC	26-1200 090-5044-00T
#29	FLASH RGT RAMP BOT	Q29	I/O Pwr. Drvr.	BLK-GRN	J6-P5	ORG	J6-P10	20v DC	#906 Bulb 165-5004-00
#30	LEFT RAMP DIVERTER	Q30	I/O Pwr. Drvr.	BLK-BLU	J6-P6	BRN	J7-P1	20v DC	32-1800 090-5031-00
#31	RIGHT RAMP DIVERTER	Q31	I/O Pwr. Drvr.	BLK-VIO	J6-P7	BRN	J7-P1	20v DC	32-1800 090-5031-00
#32	TOP LANE UP/DN POST	Q32	I/O Pwr. Drvr.	BLK-GRY	J6-P8	BRN	J7-P1	20v DC	26-1200 090-5044-00T

Note: In Test Flash Lamps Menu ("Flash" Icon), Flashers tested are all Flash Lamps located between Q1-Q32 (This Game:)

Auxiliary (UK ONLY)

	Drive Transistor (D.T.)	Driver Output Board	D.T. Control Line Color	D.T. Control Line Connect	Power Line Color	Power Line Connection	Power Voltage	Coil (GA-Turn) or Bulb Part #
AUX 1: LEFT UP/DOWN POST	Q1	Sol. Expander (Aux. Board)	WHT	J3-P11	BRN	J7-P1	20v DC	26-1200 090-5044-00T
AUX 2: CENTER UP/DOWN POST	Q2	Sol. Expander (Aux. Board)	RED	J3-P10	BRN	J7-P1	20v DC	23-1100 090-5030-00T
AUX 3: RIGHT UP/DOWN POST	Q3	Sol. Expander (Aux. Board)	ORG	J3-P9	BRN	J7-P1	20v DC	26-1200 090-5044-00T

Sec. 5: Schematics ...

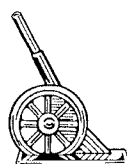

Backbox Wiring

Backbox I/O Power Driver Board Detailed Wiring Diagram

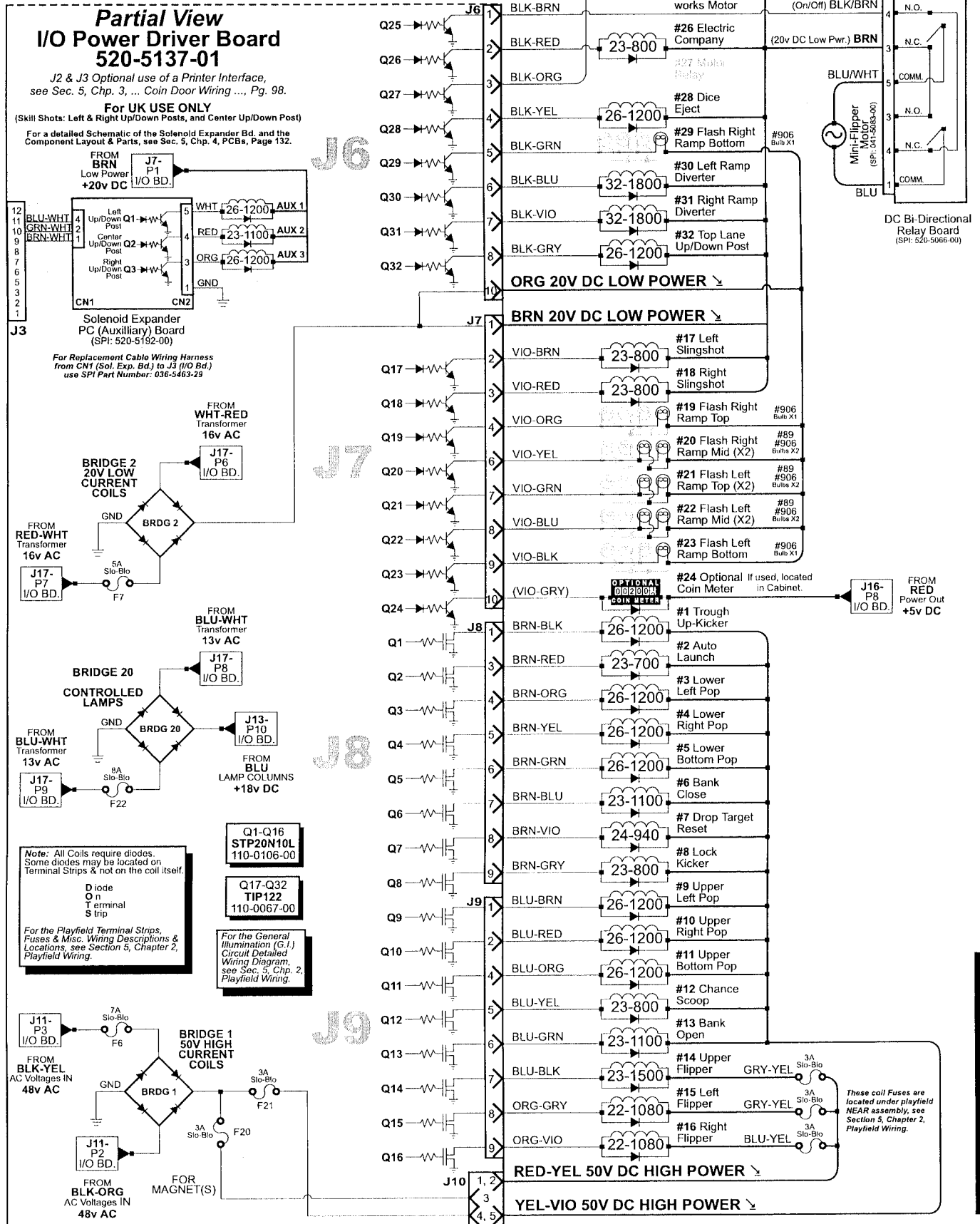

Backbox Board Layout Wiring Diagram

Important Note:

When connecting any Ribbon Cable, always ensure the "Red Line" side of the ribbon cable goes to the Pin-1 side of any Dual 0.1" Header Connector.

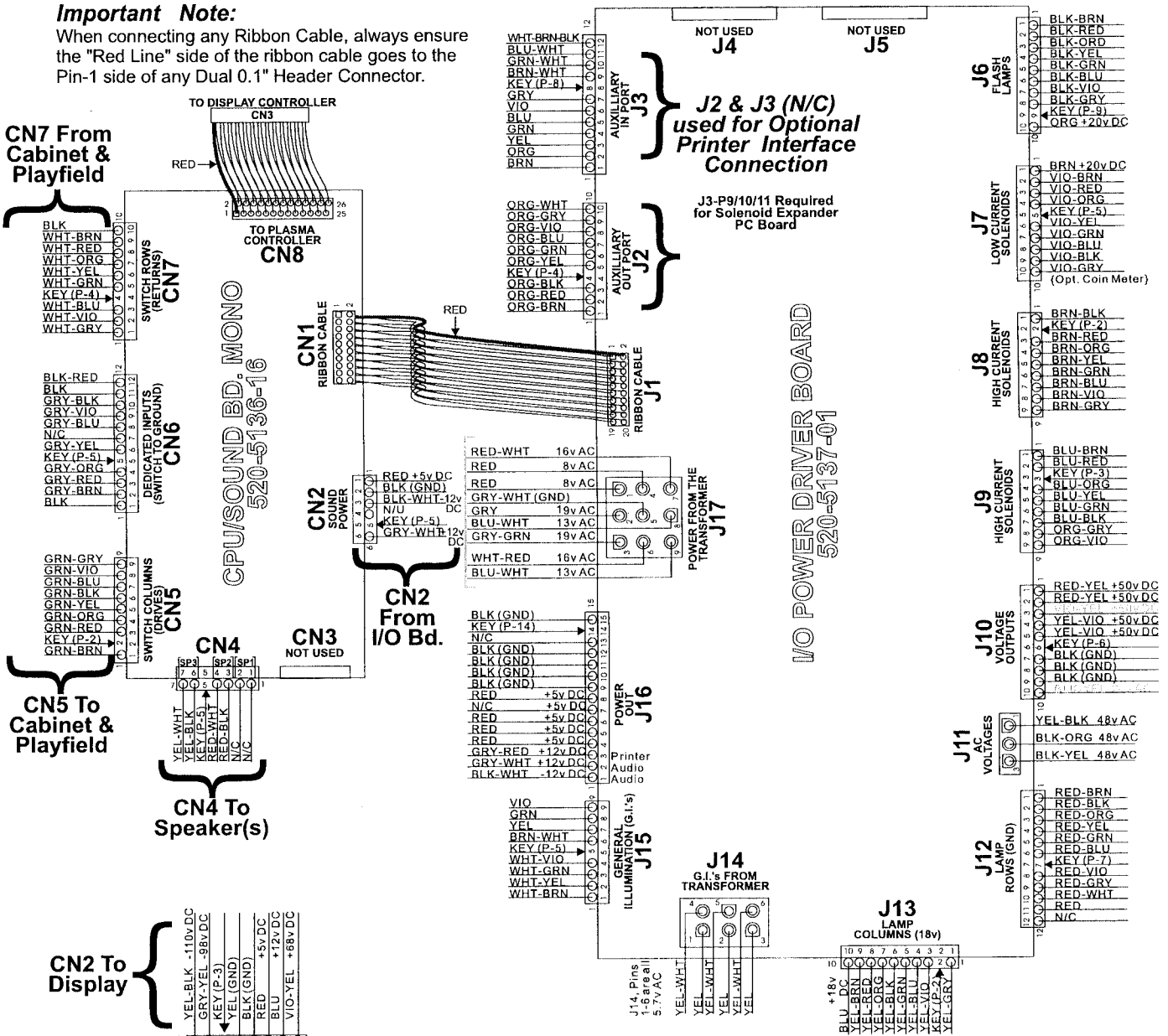

Located behind the Dot Matrix Display

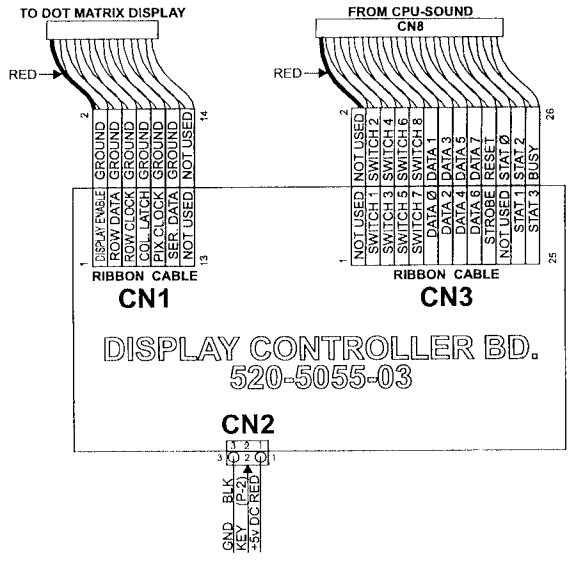

Sec. 5: Backbox ...



Playfield Wiring

General Illumination Circuit Detailed Wiring Diagram

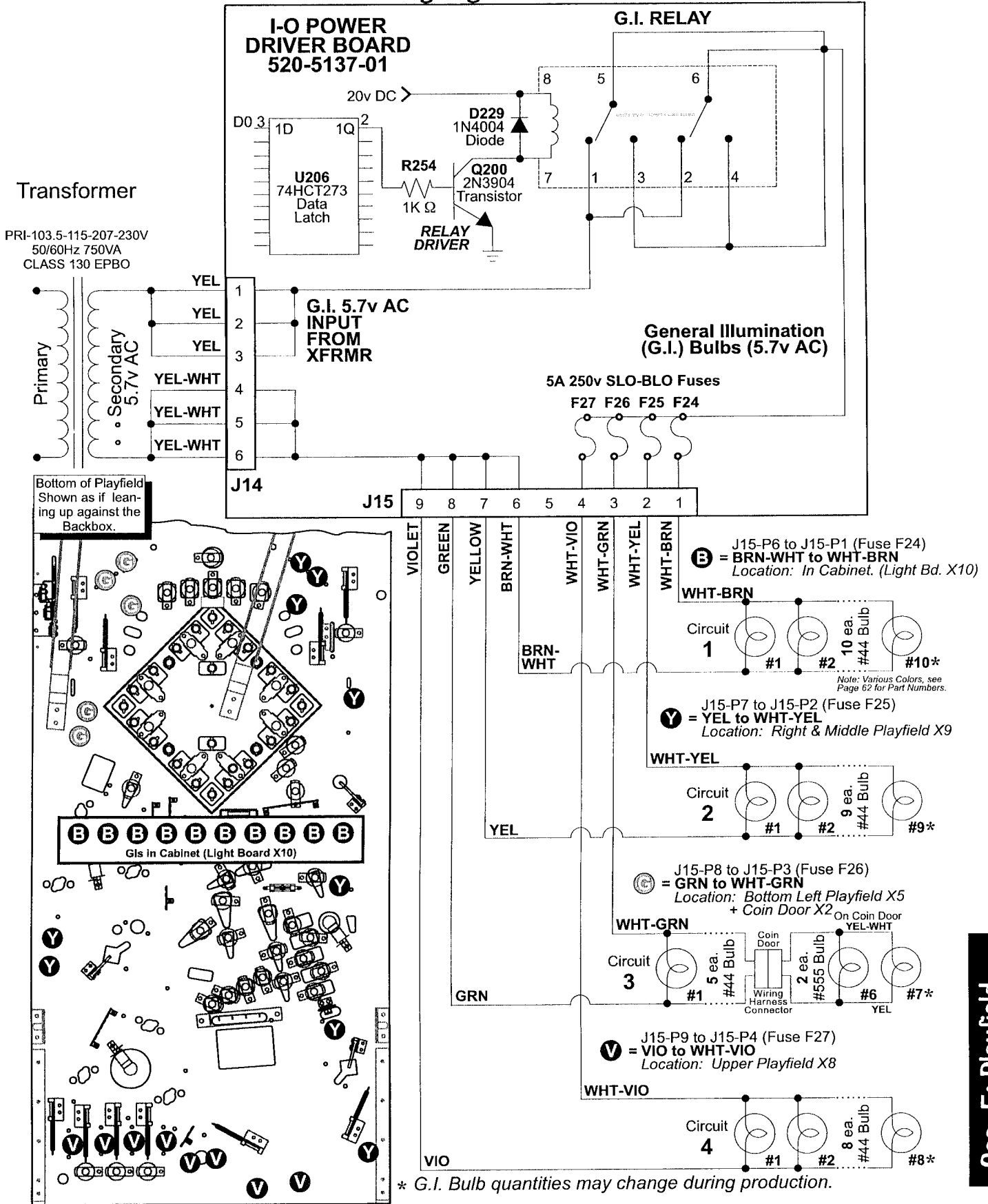

Sec. 5: Playfield ...



Playfield Switch Wiring Diagram

Note: All switches require diodes. Some diodes are located on Terminal Strips OR on a Diode Board (under playfield) & not on the switch itself.

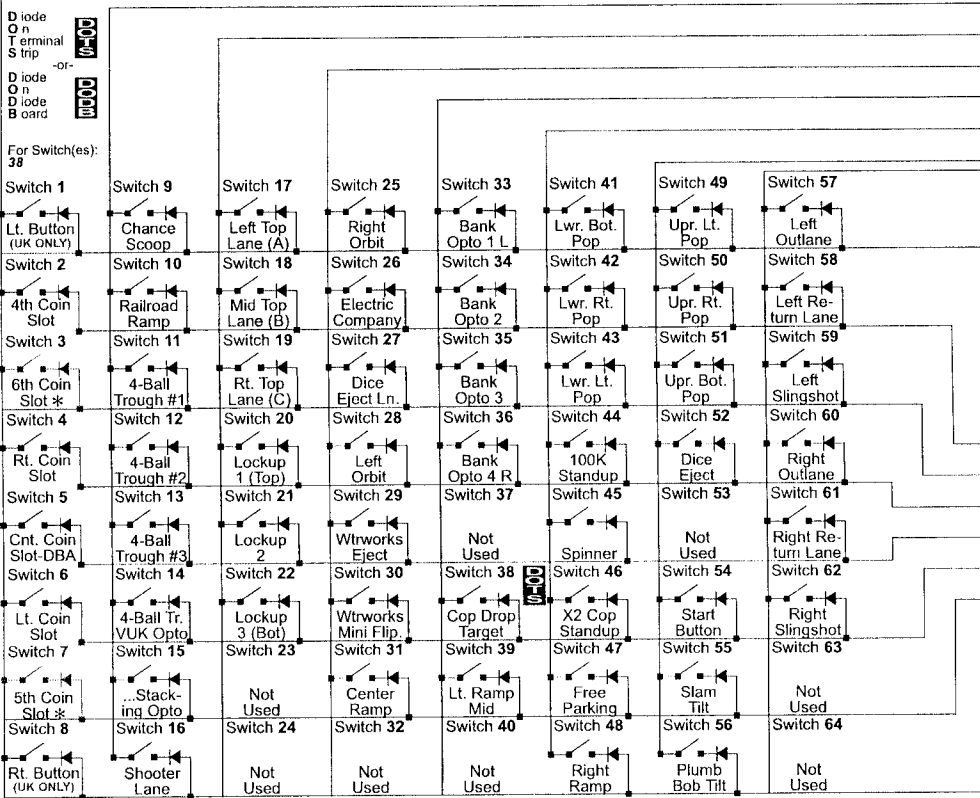

CPU-Snd. Bd. CN5-

GRN-BRN	1	Sw. Drive 1: Q1
GRN-RED	3	Sw. Drive 2: Q2
GRN-ORG	4	Sw. Drive 3: Q3
GRN-YEL	5	Sw. Drive 4: Q4
GRN-BLK	6	Sw. Drive 5: Q5
GRN-BLU	7	Sw. Drive 6: Q6
GRN-VIO	8	Sw. Drive 7: Q7
GRN-GRY	9	Sw. Drive 8: Q8

Color
Pin
Switch Drive Transistor
Source N°: 2N3904

CPU-Snd. Bd. CN7-

WHT-BRN	10	N/C
WHT-RED	9	Sw. Return 1: U400
WHT-ORG	8	Sw. Return 2: U400
WHT-YEL	7	Sw. Return 3: U400
WHT-GRN	6	Sw. Return 4: U400
WHT-BLU	5	Sw. Return 5: U401
WHT-VIO	3	Sw. Return 6: U401
WHT-GRY	2	Sw. Return 7: U401
	1	Sw. Return 8: U401

Color
Pin
Switch Return IC
Source N°: LM339AN

Please Note: Switch & Lamp Descriptions may differ slightly than that of the Dot Display due to space restraints.

Playfield Lamp Wiring Diagram

Note: All lamps require diodes. Some diodes are located on Terminal Strips (under playfield) & not on the lamp itself.

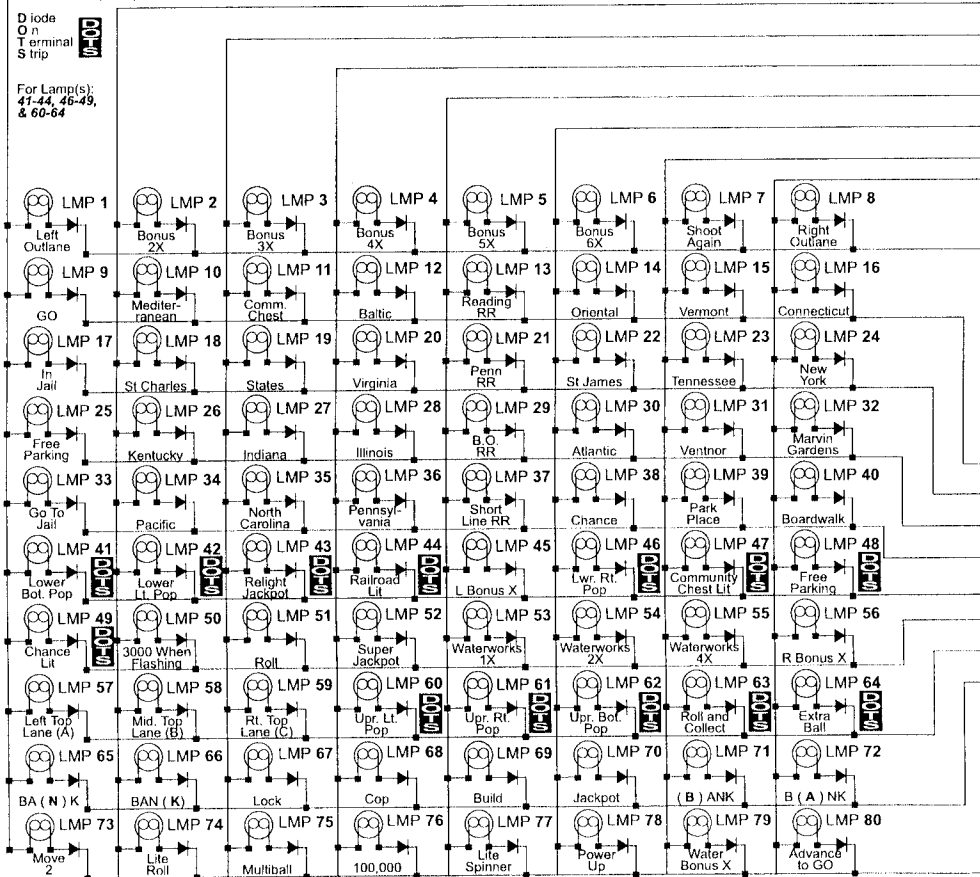

I-O Bd. J13-

YEL-BRN	10	BLUE	Power Out for +18v for Disp. Pwr. Sup. Bd. CN1-Pin 6
YEL-RED	9	Lamp Drive 1: U17	
YEL-ORG	8	Lamp Drive 2: U16	
YEL-BLK	7	Lamp Drive 3: U15	
YEL-GRN	6	Lamp Drive 4: U14	
YEL-BLU	5	Lamp Drive 5: U13	
YEL-VIO	4	Lamp Drive 6: U12	
YEL-GRY	3	Lamp Drive 7: U11	
	1	Lamp Drive 8: U10	

Color
Pin
Lamp Drive IC
Source N°: VN02N

I-O Bd. J12-

RED-BRN	1	Lamp Return 1: Q33
RED-BLK	2	Lamp Return 2: Q34
RED-ORG	3	Lamp Return 3: Q35
RED-YEL	4	Lamp Return 4: Q36
RED-GRN	5	Lamp Return 5: Q37
RED-BLU	6	Lamp Return 6: Q38
RED-VIO	8	Lamp Return 7: Q39
RED-GRY	9	Lamp Return 8: Q40
RED-WHT	10	Lamp Return 9: Q41
RED	11	Lamp Return 10: Q42
	12	N/C

Color
Pin
Lamp Return Transistor
From I-O Pwr. Driver Board J16-Pins 9-15
Source N°: STP19N06L

Sec. 5: Playfield ...



Playfield Terminal Strips, Fuses & Misc. Wiring Descriptions & Locations

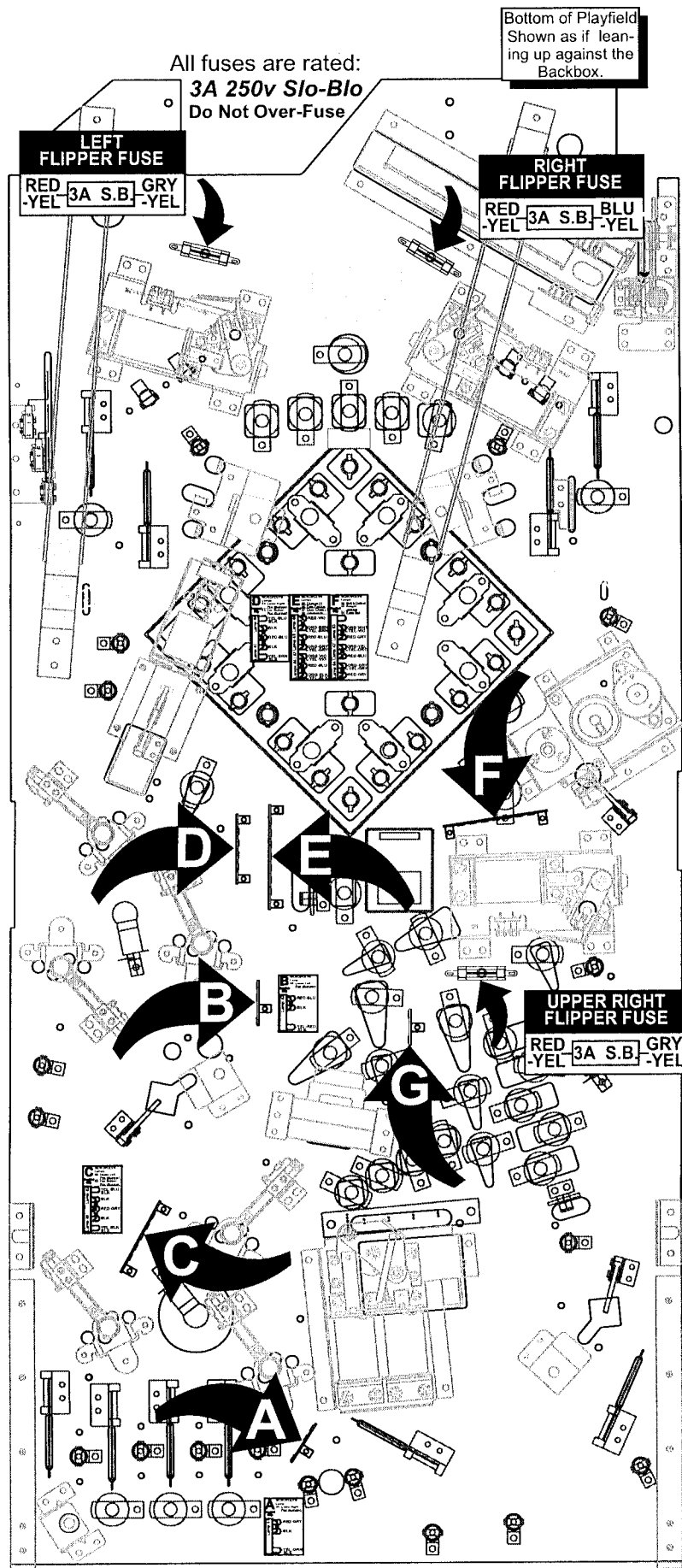

Explanation:

All switches, lamps, coils require diodes. The diodes not physically located on the switch, lamp or coil are located on Terminal Strips or Diode Bd. under the playfield. The Switch & Lamp Matrix Grids also note which switch or lamp has a diode on a Terminal Strip (noted by "DOTS" meaning: "Diode on Terminal Strip") or Diode Board (noted by "DODB" meaning: "Diode on Diode Board").

Please Note: Terminal Strip(s), Diode Board(s) and/or Fuse Holder(s) locations shown, represent the general location (your game may differ slightly).

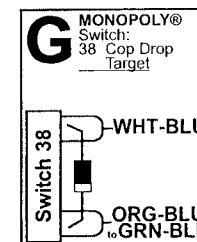
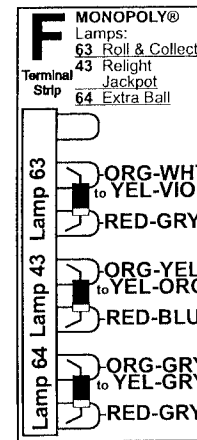
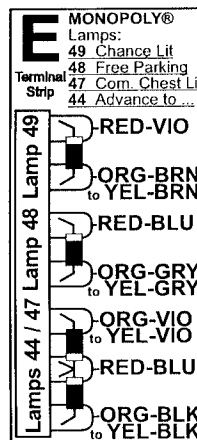
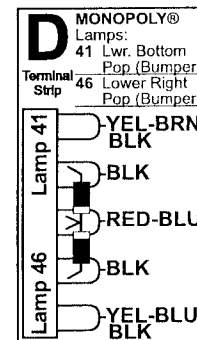
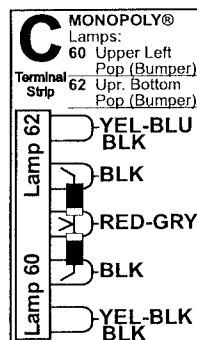
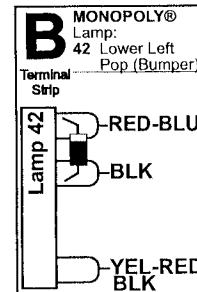
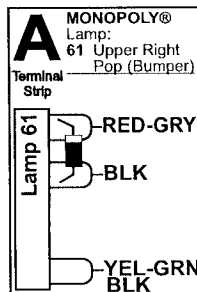

See the Pink Pages, Playfield - General Parts (Below) (Pg. 54) for Terminal Strips, Diodes, Fuses and Fuse Holders Part N^os.



3-Flipper Circuit Wiring Diagram

The **White Star Board System™** has allowed us to *simplify* the *Flipper Circuit* to the point where we have *eliminated* the *Flipper Board* all together. The *Flipper Circuit* is now configured the same as any other Solenoid Drive Circuit.

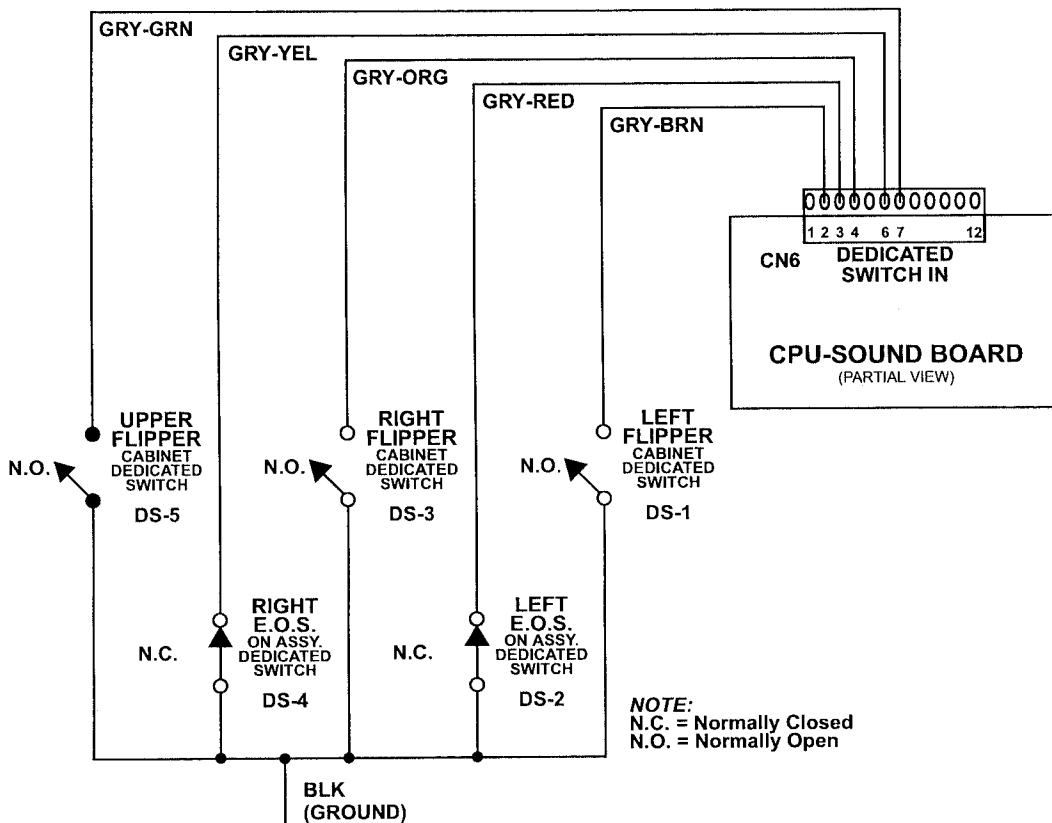

Technical Overview

Our **Flipper System** uses one supply voltage (50v DC) for both **kick & hold**. Once the **Game CPU** detects a Flipper Cabinet closure (during game play) it applies a 40msec pulse to the gate of the Flipper Drive Transistor (STP-20N10L). If it continues to detect a Flipper Cabinet Switch closure (*the player holding the button in*) it will continue to pulse the flipper drive transistor 1msec every 12msecs for the duration of the hold cycle.

The **E.O.S.** (End-Of-Stroke) **Switch** serves the same function as before as it prevents foldback when the player has the flipper energized to capture balls. The **E.O.S. Switch** is a normally closed switch which opens approximately 1/16" when the flipper is energized. The **Game CPU** will detect a switch closure if the flipper bat is forced back by a high velocity shot or rebound on the playfield and will apply another 40msec pulse of 50v DC to the coil.

Note: If an Upper Flipper is used, the Flipper Button (on the same side of the cabinet as the Upper Flipper) will have a "Double-Stacked" E.O.S. Switch. This allows the player to push the Flipper Button either half-way down to energize only the Lower Flipper or pushing the Flipper Button all the way down to energize both the Lower & Upper Flippers.

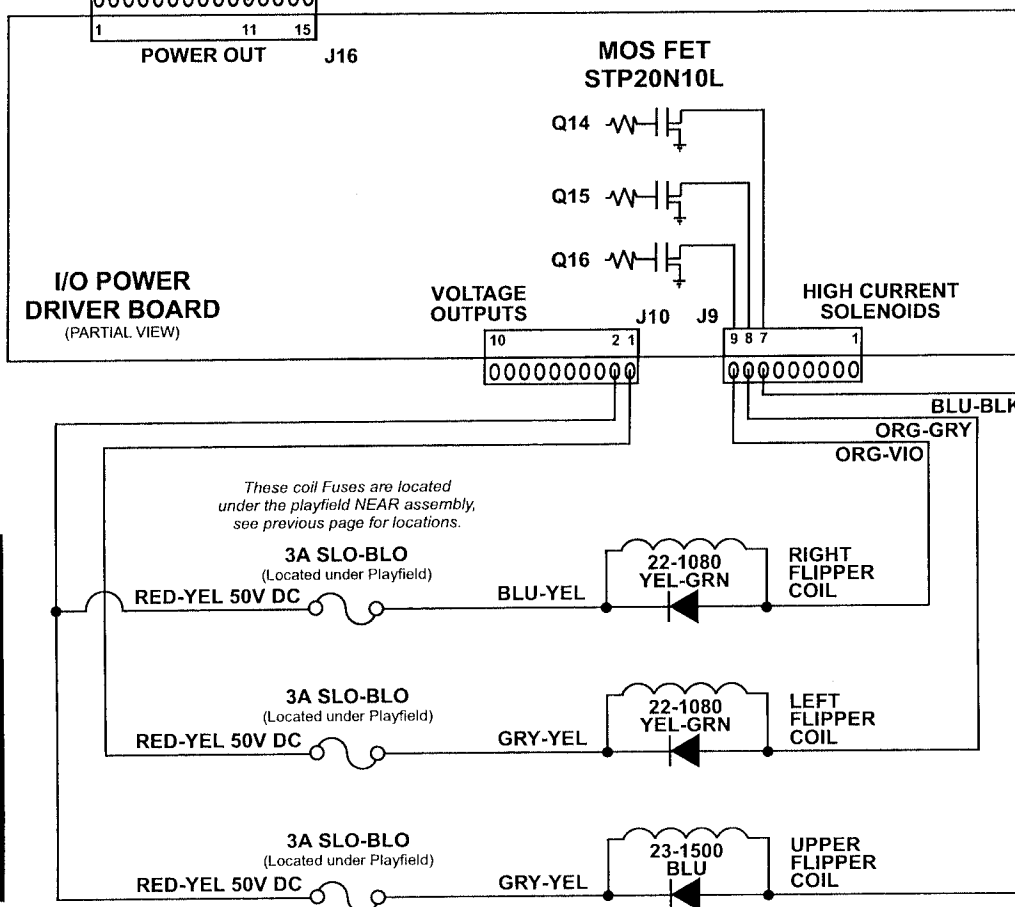

Sec. 5: Playfield ...

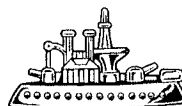

Cabinet / Coin Door Wiring Diagram

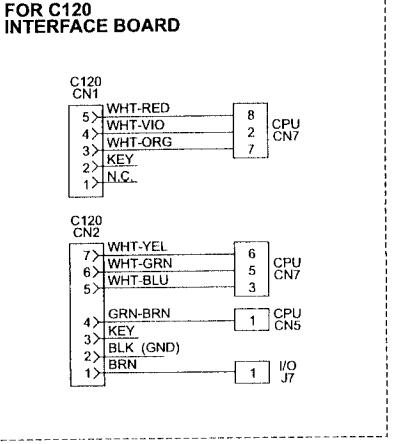
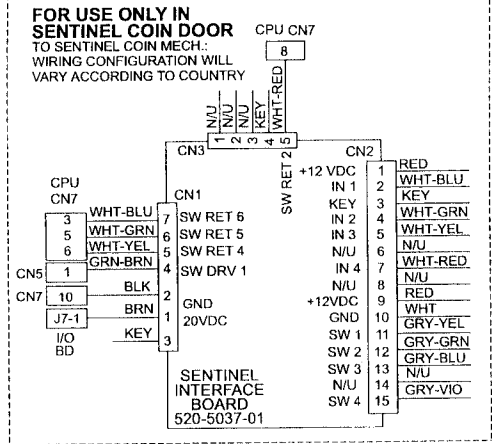
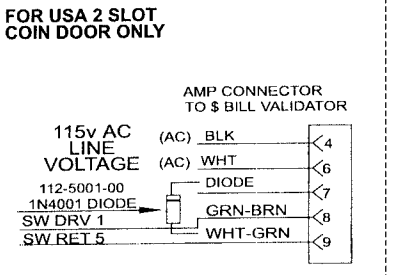
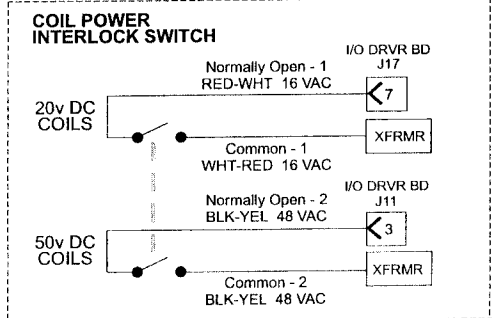
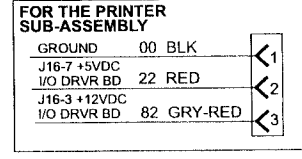
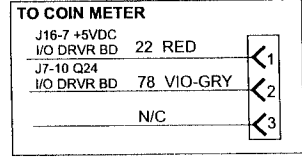
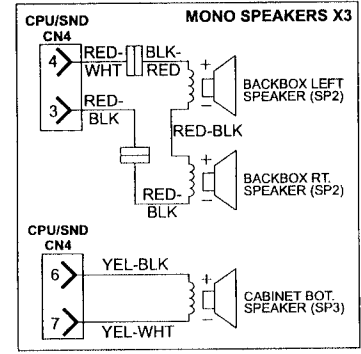
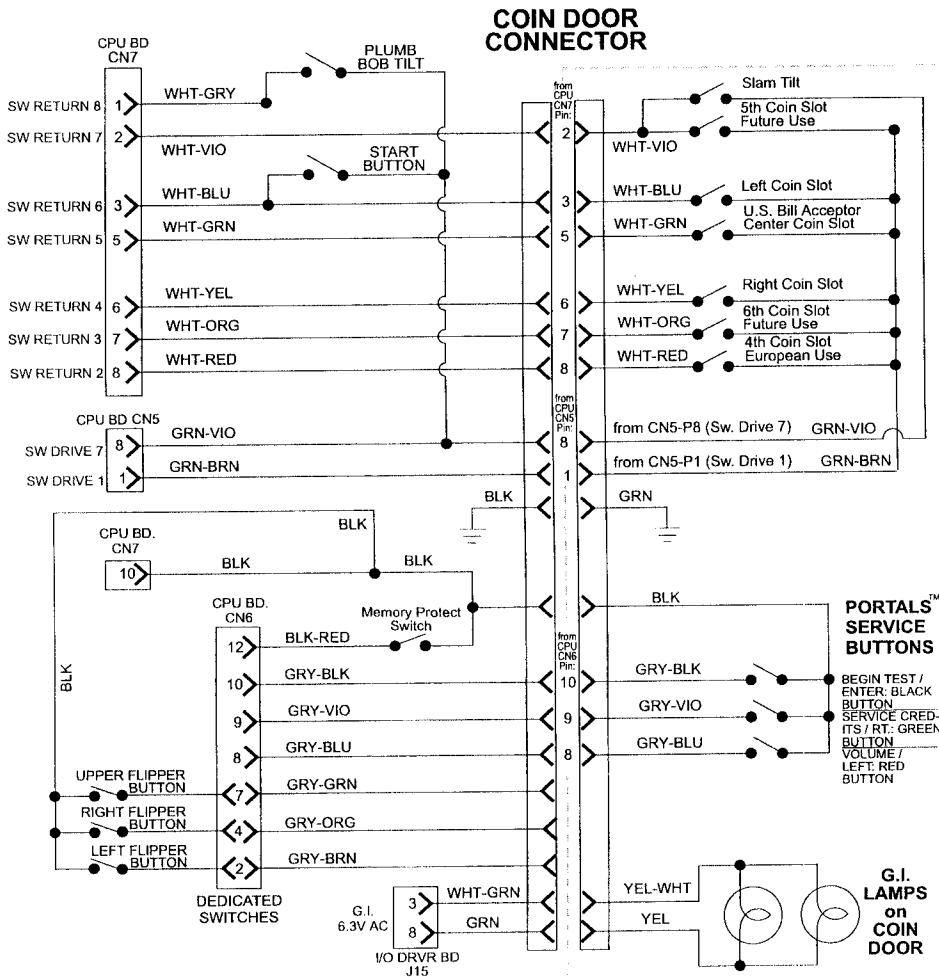

UK ONLY: 2 Extra Cabinet Buttons for the Post Save™ Feature are used. The Left Button operates the Left Outlane Ball Deflector. The Right Button operates the Right Outlane Ball Deflector. Both buttons pushed together, operate the Center Up/Down Post. Both buttons are located under the Flipper Buttons.

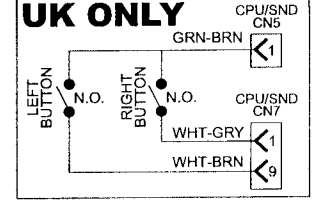

PRINTER INTERFACE OPTIONAL

Cable Wiring Harness SPI Part N°:
 036-5408-00
 RS-232 Printer Interface Board SPI Part N°:
 520-5069-00

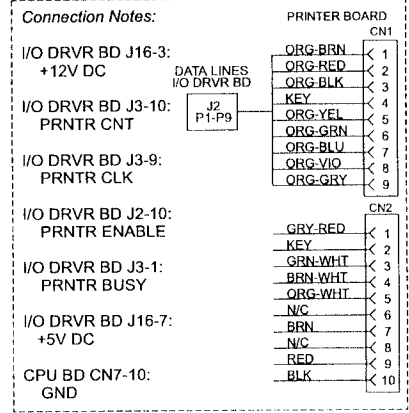

Sec. 5: Cabinet ...

COIN DOOR



Printed Circuit Boards (PCBs)

Trough Up-Kicker Dual OPTO Boards Theory of Operation & Schematic

As light from the **Transmitter LED1** falls on the **Receiver LED1**, it generates a Positive Bias Voltage (0.7v to 1.5v) which is applied to the **Gate (G)** of **Q1 (Fet 2N5460)** turning **Q1** off. When **Q1** is held off, no current flows through **Q2's (2N3906) Base (B)**. With no *base current*, **Q2** is off and acts as an **OPEN SWITCH**. When the light is interrupted (**BLOCKED**) **R1 (Rec. Bd.)** bleeds the gate voltage off of **Q1** allowing it to conduct, switching **Q2** on, which acts as a **CLOSED SWITCH**. The **LED2 (Trans/Rec) Circuit** operates identical as the **LED1 Circuit**.

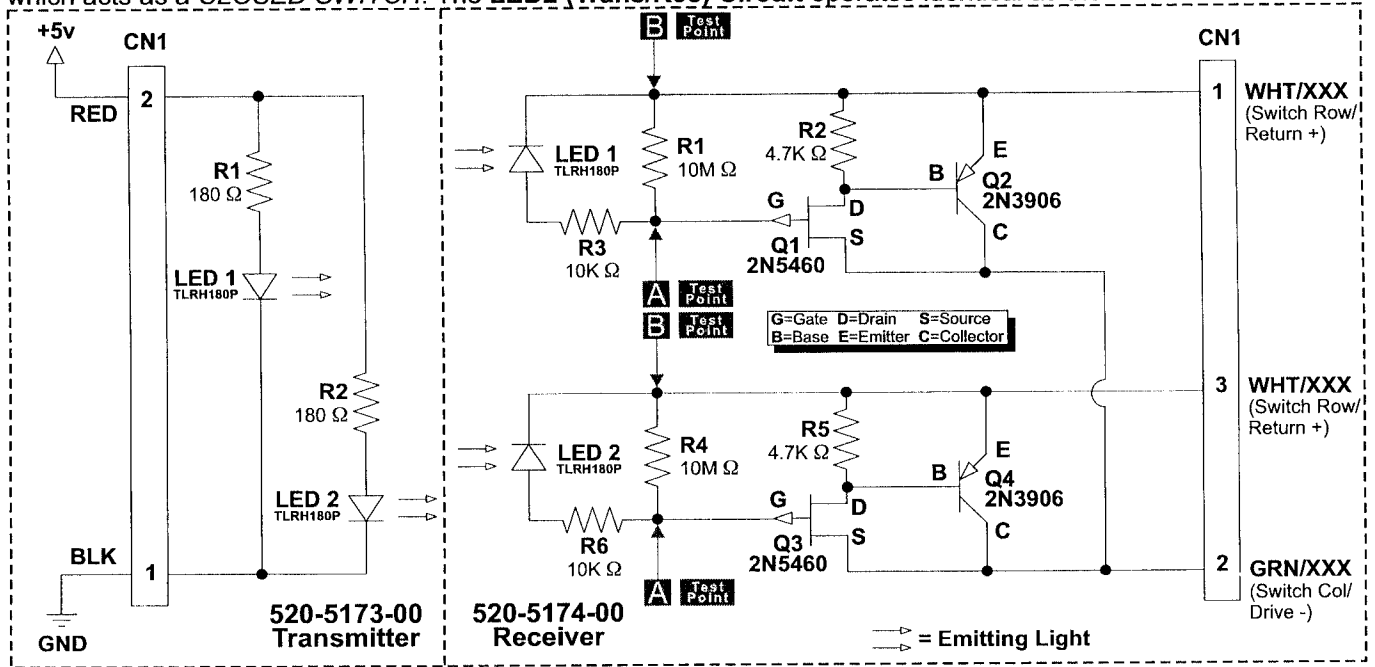

Trough Up-Kicker Dual OPTO Boards Component Layout & Parts

520-5173-00 (TRANS)

Boards Actual Size

520-5174-00 (REC)

(Screened Text Printed Larger for Clarity)

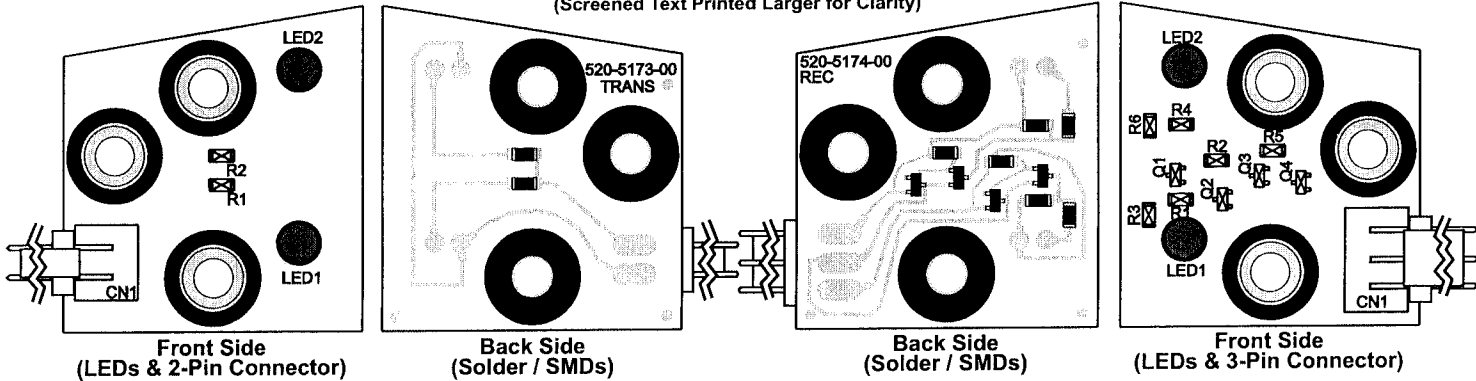

ITEM	QTY	PART NUMBER	REF-DESIGNATOR	DESCRIPTION
A	1	515-0173-00	Dual-OPTO Trans. Bd. Assy.	PCB Assy. (with all Items 1-5)
—	1	520-5173-00	Dual-OPTO Trans. Bd.	PCB Assy. (with Items 1-3 only)
01	1	045-5111-02	CN1	2X, .156" Rt. Angle (26-60-5020) Conn.
01	2	165-5052-00	LED1, LED2	LED TLRH180P (Ultra Bright Red)
04	3	530-5308-02	n/a	OPTO PCB Brass Tube Spacer
03	3	545-5518-00	n/a	OPTO PCB Rubber Grommet
05	2	121-5067-00	R1, R2	180 Ω 1/8W Chip Res. (CRCW)
B	1	515-0174-00	Dual-OPTO Rec. Bd. Assy.	PCB Assy. (with all Items 1-9)
—	1	520-5174-00	Dual-OPTO Rec. Bd.	PCB Assy. (with Items 1-7 only)
01	1	045-5111-03	CN1	3X, .156" Rt. Angle (26-60-5030) Conn.
02	2	165-5052-00	LED 1, LED 2	LED TLRH180P (Ultra Bright Red)
04	3	530-5308-02	n/a	OPTO PCB Brass Tube Spacer
03	3	545-5518-00	n/a	OPTO PCB Rubber Grommet
05	2	110-5006-00	Q1, Q3	2N5460, Transistor (P-FET SOT-23)
06	2	110-0086-00	Q2, Q4	2N3906, Transistor
07	2	121-5082-00	R1, R4	10M Ω 1/8W Chip Res. (CRCW)
08	2	121-5083-00	R2, R5	4.7K Ω 1/8W Chip Res. (CRCW)
09	2	121-5011-00	R3, R6	10K Ω 1/8W Chip Res. (CRCW)

Replacement Part:
 LED TLRH180P
 (T1-3/4 GaAlAs)
 SPI Part N°:
165-5052-00



OPTO Troubleshooting

1. Volt Meter Test (indicates normal operating condition):

A. **OPEN OPTO** (Light Falling on LED) = **SWITCH OPEN**. Place meter leads across points **A** and **B** on the **LED1 Circuit** (Refer to Schematic Drawing on previous page, 520-5174-00 Receiver Side). It should read approximately 0.8 - 1.2v DC. The **LED2 Circuit** operates the same.

B. **CLOSED OPTO** (Light Blocked) = **SWITCH CLOSED**. Place meter leads across points **A** and **B** on the **LED1 Circuit** (Refer to Schematic Drawing on previous page, 520-5174-00 Receiver Side). It should read approximately 0.0 - 0.1v DC. The **LED2 Circuit** operates the same.

2. Oscilloscope Test (indicates normal operating condition):

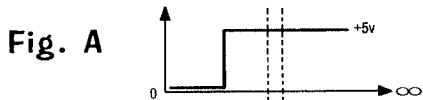

A. **OPEN OPTO** (Light Falling on LED) = **SWITCH OPEN**. Place Scope lead at **Pin-1** of OPTO Rec. Board with Scope Grounded (see Schematic). The Scope should display a **STEADY +5v** as shown in **Fig. A**, Wave Form Diagram.

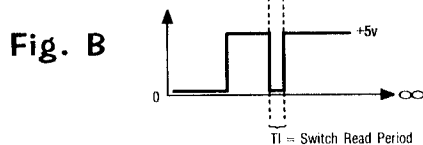

B. **CLOSED OPTO** (Light Blocked) = **SWITCH CLOSED**. Place Scope lead at **Pin-1** of OPTO Rec. Board with Scope Grounded (see Schematic). The Scope should display a **PULSE STREAM** indicating **Q2** has switched "On" as shown in **Fig. B**, Wave Form Diagram. This is your Switch Drive Pulse.

3. Bench Test (See Fig. C):

Please Note: To perform this test you must use a spare 560Ω Pull-Up Resistor, SPI N^o: 121-5047-00

Disconnect the OPTO Transmitter / Receiver Board from the circuit. Connect one side of a 560Ω Pull-Up Resistor to **Pin-1** of the OPTO Receiver Bd. and the other side of the resistor to a 5v DC source. Connect **Pin-2** to GND. Connect a +5v DC source to **Pin-1** of the Transmitter & GND to **Pin-2**. Align with the Receiver OPTO approx. 3" distance. Using your Volt-Meter or an Oscilloscope, monitor **Pin-1** while **BLOCKING** and **UNBLOCKING** the **BEAM** from the Trans. The output will be approx. +5v DC when the **BEAM IS NOT BLOCKED** and approx. 0v when the **BEAM IS BLOCKED**.

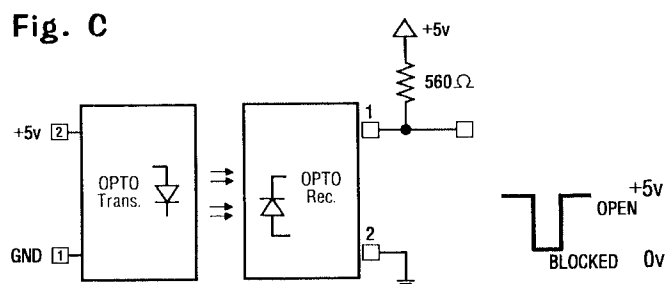

Trough Dual OPTO Boards Alignment / Test for LED1

When a working **OPTO** is installed and connected in a game, the transmitter should light (LED1 lower & LED2 upper) when the power is switched on. With the playfield in Service Position #1 (playfield lifted up in the half-way position resting on the Prop Rod or edge slide support brackets) and the game on, the LED lights should show up as a **BRIGHT RED RINGS** through the back of the Receiver Board around the **Receivers LED1 & LED2** (See **Fig. 1**). Testing only **LED1**: With the game in **Switch Test Mode**, lifting the Trough Plunger with a fingertip should block the **BEAM** and cause the Switch Position to trigger (See **Fig. 2**). View **Fig. 2a & 2b** (on the next page) for a sectional view of the Light Path (note alignment) and what happens as a ball breaks the light beam.

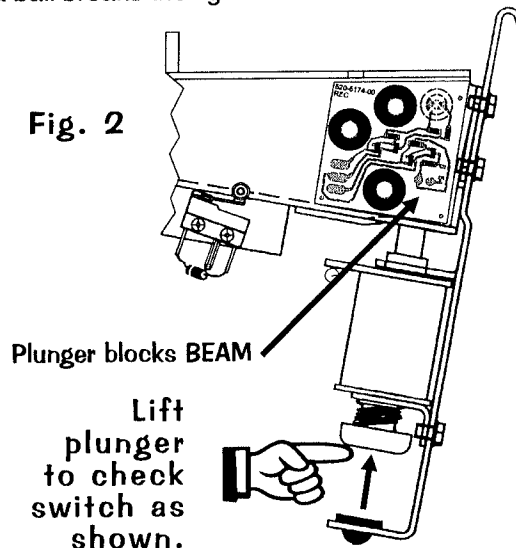
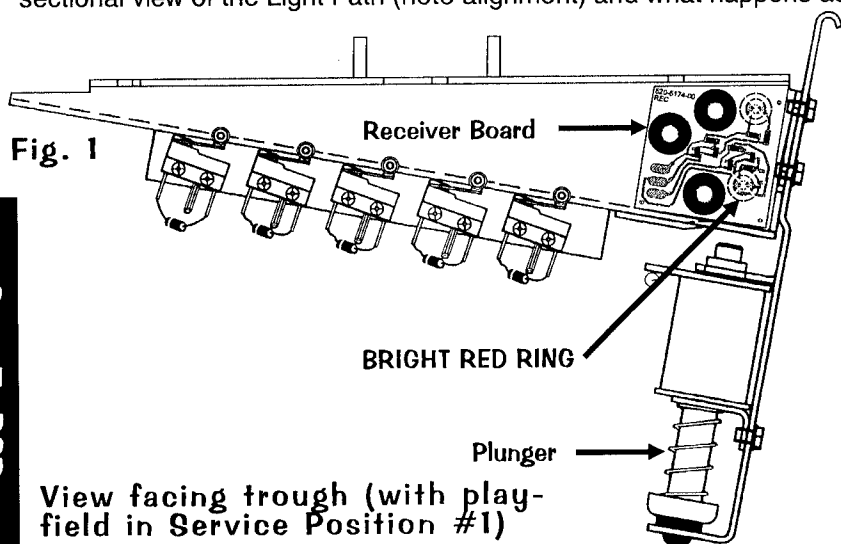

View facing trough (with playfield in Service Position #1)



Sectional view from right (Fig. 2a & 2b)

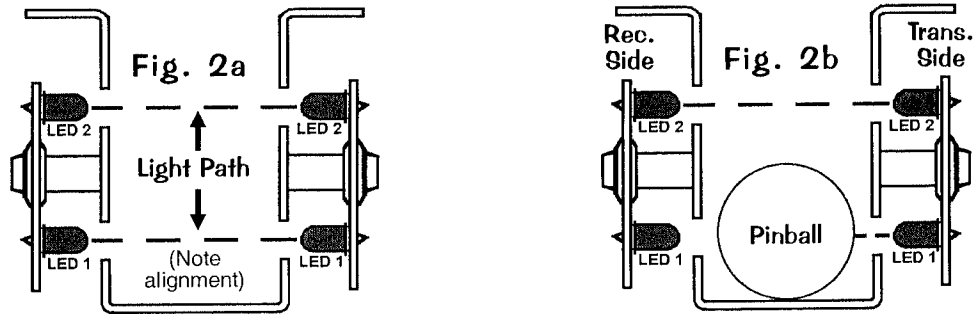

Trough Dual OPTO Boards Alignment / Test for LED2

When a working **OPTO** is installed and connected in a game, the transmitter should light (LED1 lower & LED2 upper) when the power is switched on. With the playfield in Service Position #1 (playfield lifted up in the half-way position resting on the Prop Rod or edge slide support brackets) and the game on, the LED lights should show up as a **BRIGHT RED RINGS** through the back of the Receiver Board around the **Receivers LED1 & LED2** (See Fig. 1, previous page). Testing only **LED2**: *TO PERFORM THIS TEST, A PINBALL MUST BE IN THE BALL TROUGH.* With the game in **Switch Test Mode**, lifting the Trough Plunger with a finger tip should block the **BEAM** on LED2 and cause the Switch Position to trigger (See Fig. 3). View Fig. 3a & 3b for a sectional view of the Light Path (note alignment) and what happens as a "double-stacked" ball scenario breaks the light beam.

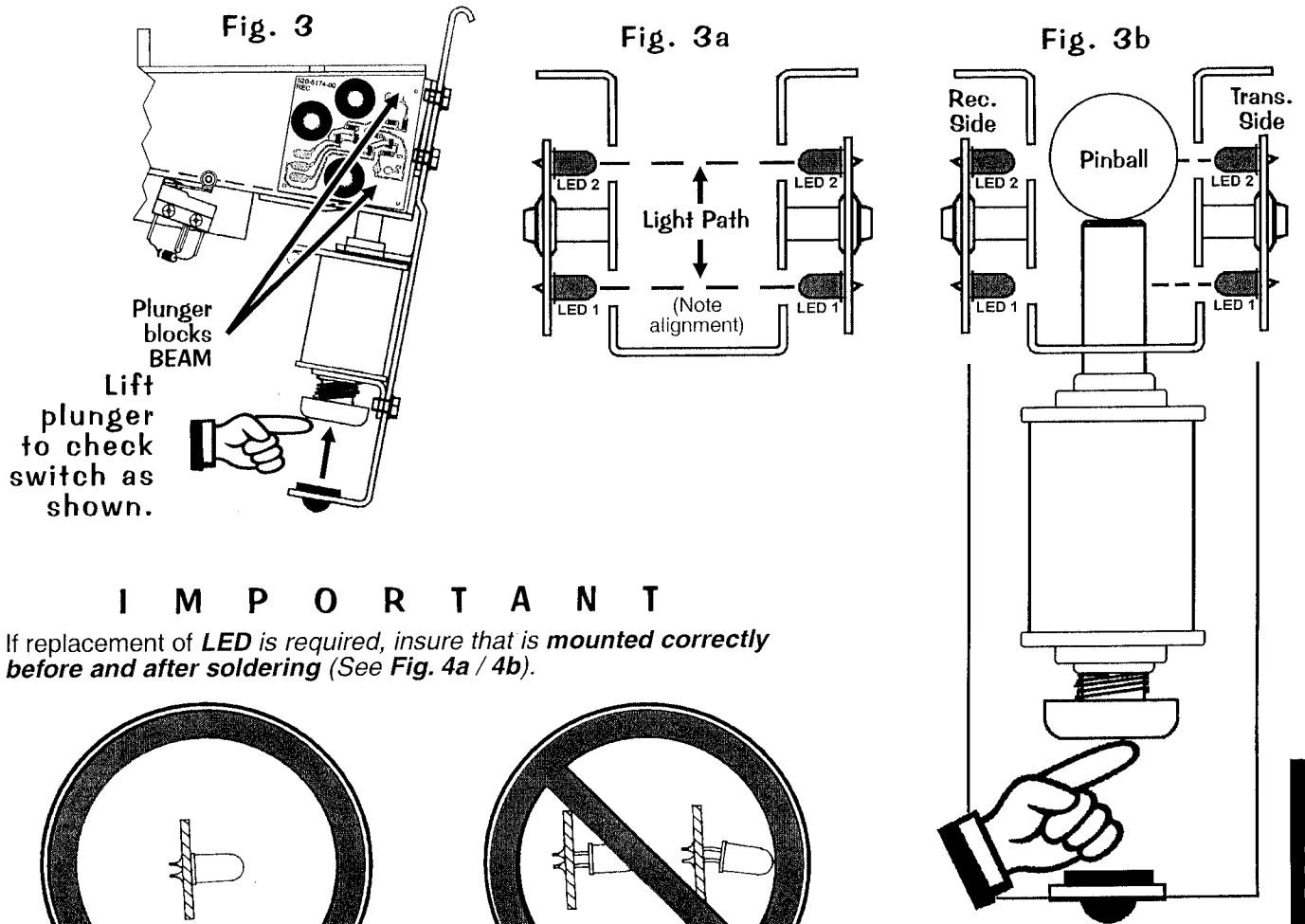

I M P O R T A N T

If replacement of **LED** is required, insure that is **mounted correctly** before and after soldering (See Fig. 4a / 4b).

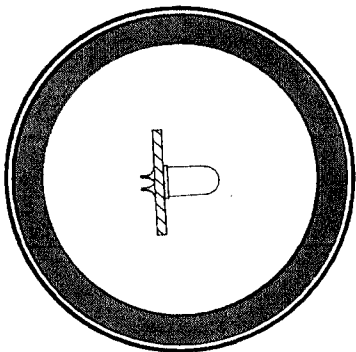

Fig. 4a
Correct Position

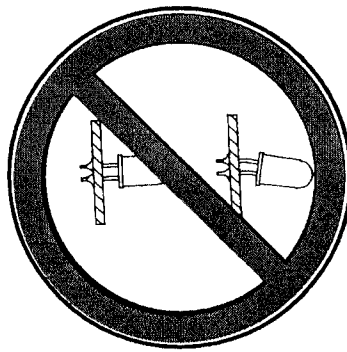
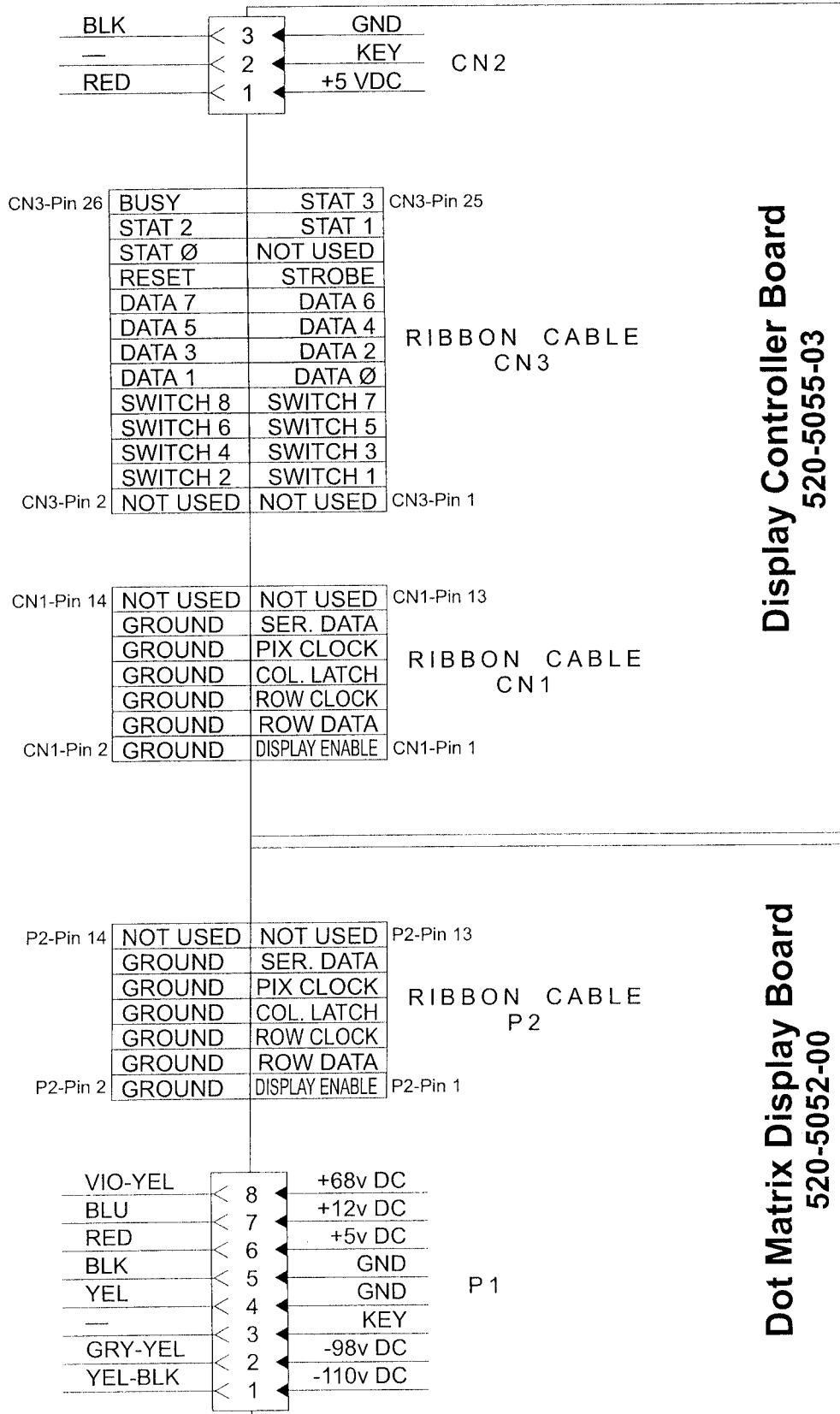

Fig. 4b
Incorrect Position



Sec. 5: PCBs



Display Power Supply Board Schematic

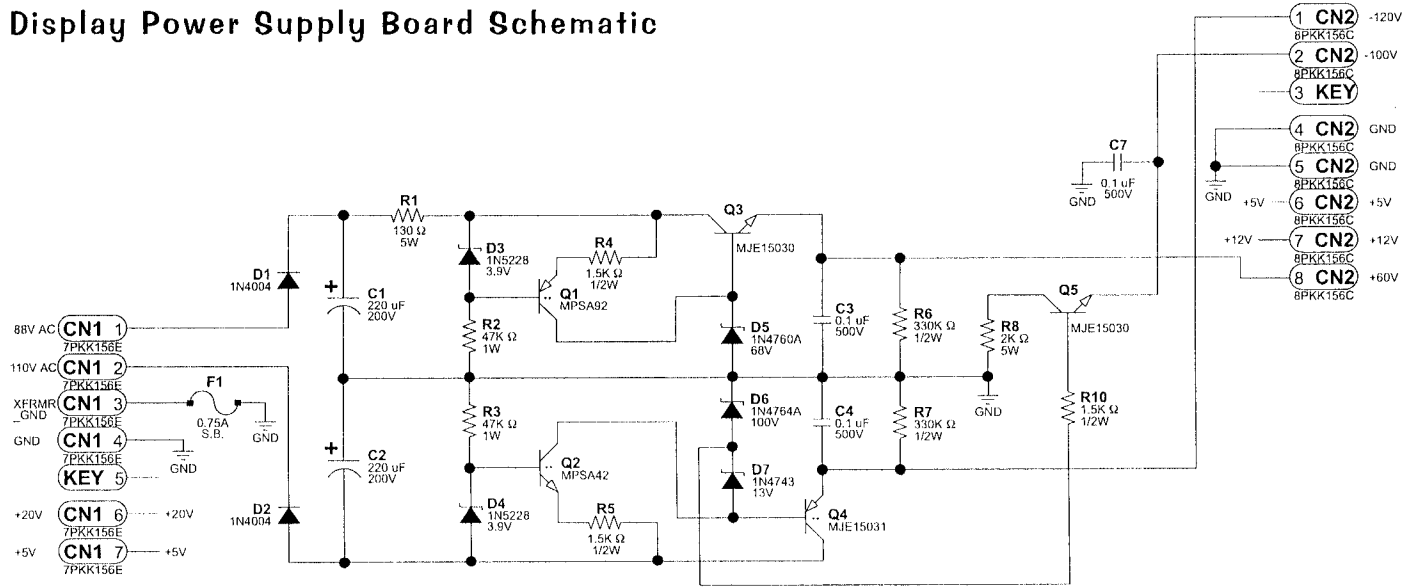

Display Power Supply Board Component Layout & Parts

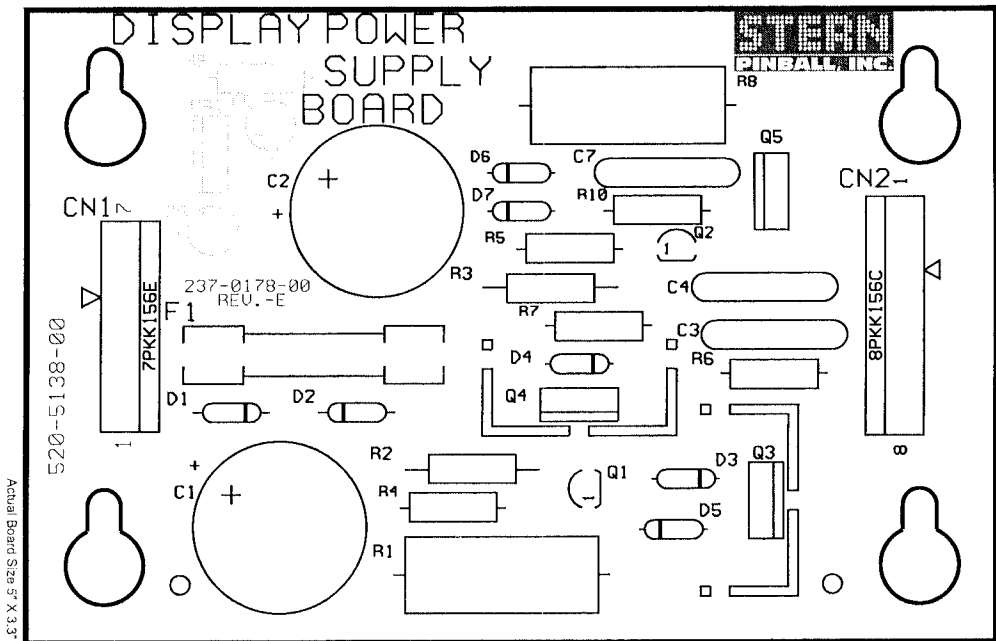

ITEM	QTY	PART NUMBER	REF-DESIGNATOR	DESCRIPTION (NS = Not Stuffed)
—	1	520-5138-00	Display Power Supply Board	Complete PCB Assembly
01	2	125-5044-00	C1, C2	220uF, 200v, Radial Lytic Cap.
02	3	125-5035-00	C3, C4, C7	0.1uF, 500v, Ceramic Disk Cap.
04	1	045-5015-07	CN1	7PKK156E (PIN5=KEY)
05	1	045-5015-08	CN2	8PKK156 (PIN3=KEY)
06	2	112-5003-00	D1, D2	1N4004, Diode
07	2	112-0053-00	D3, D4	1N5228, 3.9v, Diode
08	1	112-0062-00	D5	1N4760A, 68v, Diode
09	1	112-0049-00A	D6	1N4764A, 100v, Diode
10	1	112-0061-00	D7	1N4743, 13v, Diode
11	1	200-5000-17	F1	3/4A (0.75A) S.B. Fuse
12	2	205-0004-00	F1	Fuse Clip
13	1	110-0100-00	Q1	MPSA92, Transistor
14	1	110-0082-00	Q2	MPSA42, Transistor
15	2	110-0101-00	Q3, Q5	MJE15030, Transistor
16	2	535-5000-11	Q3, Q4	Heatsinks - AAVID #563002
17	2	240-5008-00	Q3, Q4	#6-32 KEPS Nut
18	2	237-5501-00	Q3, Q4	#6-32 X 3/8" PPH Screw
19	1	110-0103-00	Q4	MJE15031, Transistor
20	1	121-5061-00	R1	130 Ohm 5W Res.
21	2	121-5060-00	R2, R3	47K Ohm 1W Res.
22	3	121-5038-00	R4, R5, R10	1.5K Ohm 1/2W Res. (R9: NS)
23	2	121-5059-00	R6, R7	330K Ohm 1/2W Res.
24	1	121-5062-00	R8	2K Ohm 5W Res.

Sec. 5: PCBs



Display Controller Board Schematic

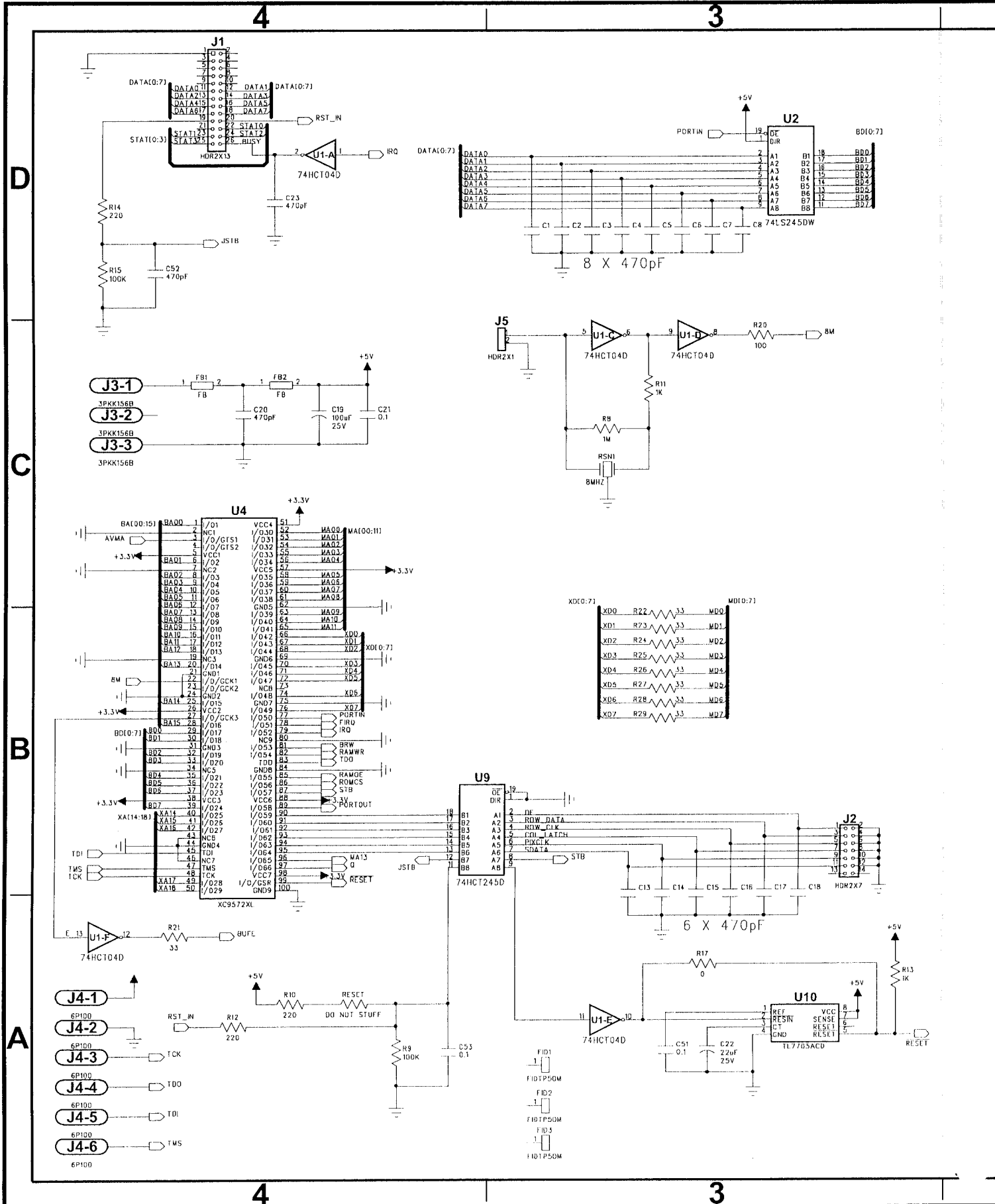

Sec. 5: PCBs



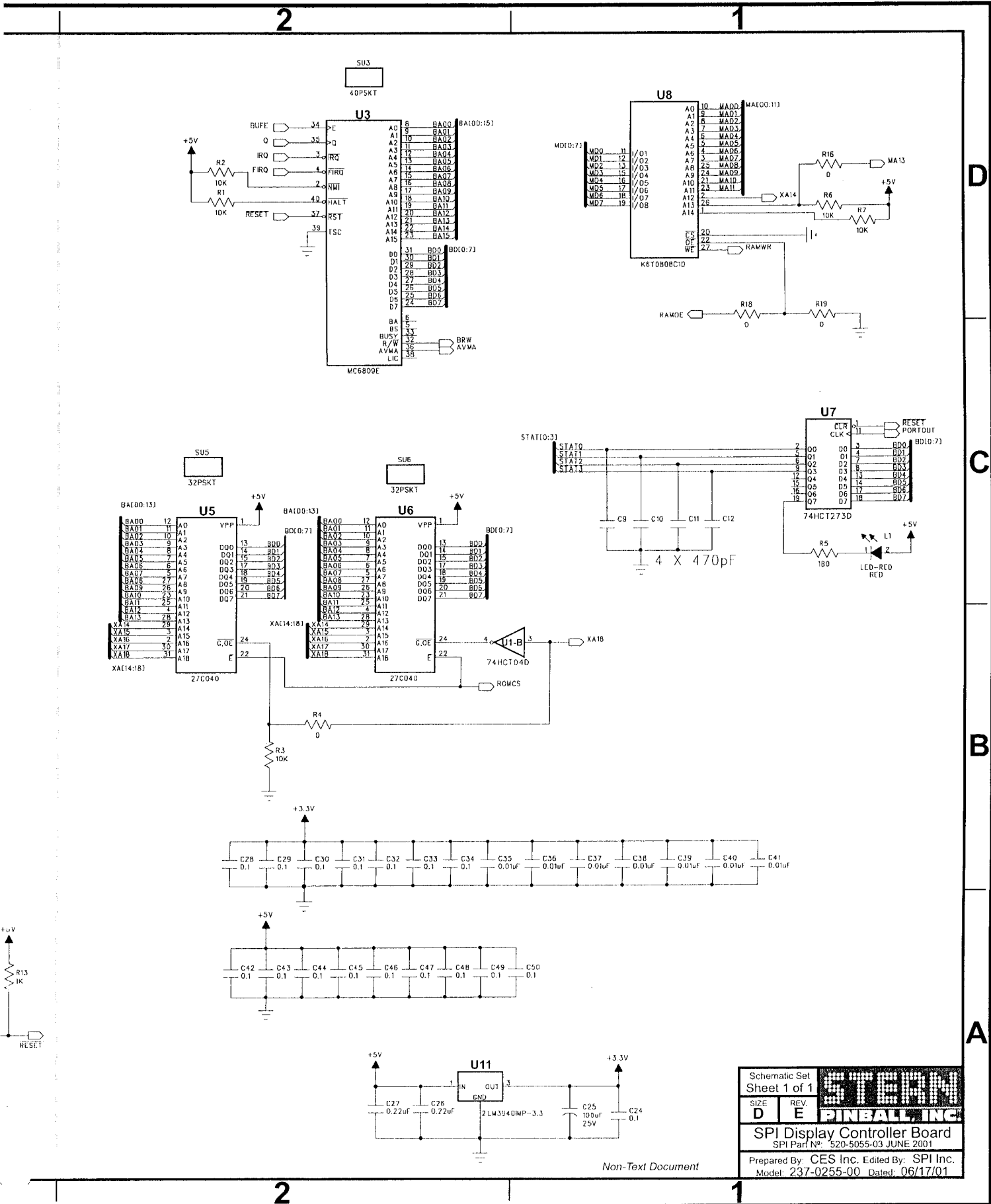

D
C
B
A

Schematic Set
Sheet 1 of 1

SIZE REV. D E

STERNA
PINBALL, INC.

SPI Display Controller Board
SPI Part N°: 520-5055-03 JUNE 2001

Prepared By: CES Inc. Edited By: SPI Inc.
Model: 237-0255-00 Dated: 06/17/01

Non-Text Document



Display Controller Board Component Layout & Parts

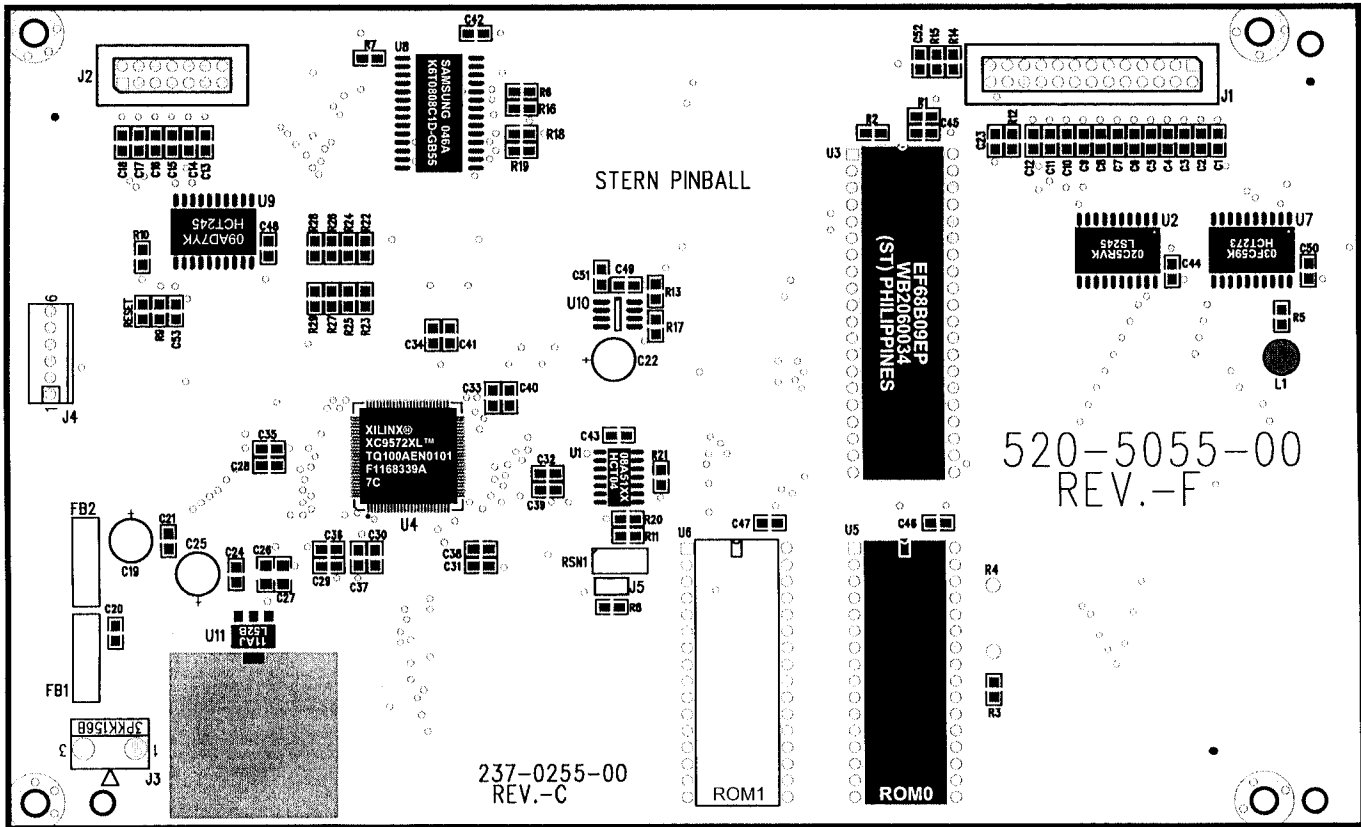

Actual Board Size 20.5cm X 12.5cm

ITEM	QTY	PART NUMBER	REF-DESIGNATOR	DESCRIPTION (NS = Not Stuffed)
—	1	520-5055-03	Display Controller Bd. (FCC FEB98) Rev. E June 2001	Complete PCB Assembly
1	2 (See Pg. DR. © Table)		U5 (ROM0)	4mB ROM 27C040 (M27C401-100)
2	2	077-5217-00	U5	32-Pin, IC Dip Socket
3	1	045-5015-03	J3	3-Pin, PKK156B Connector
4A	1	100-0189-01	U3	MC6809E
4B	1	045-	U3	40-Pin, Socket
5	1	077-	J4	6-Pin (6P100)
6	1	100-	U1	74HCT04D (74LS04)
7	1	100-	U9	74HCT245D
8	1	100-	U7	74HCT273D
9	1	100-	U2	74LS245DW
10	1	140-	RSN1	8MHZRSN (8Mhz) Cystal
11	7	125-	C35-C39, C40, C41	CAP103-0805-X7R, 0.01uF, 50v
12	20	125-	C21, C24, C28-C32, C33, C34, C42, C43, C44, C45, C46 C47, C48, C49, C50, C53	CAP104-0805, 0.1, 50v
13	2	125-	C26, C27	CAP224-1206-Z5U, 0.22uF, 50v
14	21	125-	C1-C12, C13-C18, C20, C23, C52	CAP471-0805, 470pF, 50v
15	2	n/a	FB1, FB2	Ferrite Bead, FB0370
16	3		FID1-3	FIDTP50M
18	1	045-5015-02	J2	7-Pin, Dual Row .1" Hdr. Conn HDR2X7
19	1	045-5015-26	J1	13-Pin, Dual row .1" Hdr. Conn HDR2X13
20	1	100-	U8	K6T0808C1D
21	1	165-5099-00	L1	LED T1-3/4 DIFFUSER RED
22	1	100-	U11	LM3940IMP-3.3
23	4	121-	R16-R18	RES0E1/10W0805, 0
24	1	n/a	RESET	DO NOT STUFF
26	1	121-	R20	RES100E1/10W0805, 100
27	2	121-	R9, R15	RES100K1/10W0805, 100K
28	5	121-	R1, R2, R3, R7	RES10K1/10W0805, 10K
29	1	121-	R5	RES180E1/10W0805, 180
30	2	121-	R11, R13	RES1K1/10W0805, 1K
31	1	121-	R8	RES1M1/10W0805, 1M
32	3	121-	R10, R12, R14	RES220E1/10W0805, 220
33	9	121-	R21, R22-R29	RES33E1/10W0805, 33
34	2	125-5015-00	C19, C25	TCAP100M25VER, 100uF, 25v
37	1	100-	U4	XC9572XL

Sec. 5: PCBs



I/O Power Driver Board Theory of Operation

5v Supply:

An AC voltage of approximately 9v comes into the board at [J17-(1-4)] this AC voltage is then *full-wave rectified* by bridge **BRDG 21** and filtered by Capacitor **C203**. The resulting voltage is 11v DC which is inserted into a linear voltage regulator for the output of 5v DC. This 5v regulated voltage can be adjusted by potentiometer **R116** the voltage should be set to 5.00v. Besides powering the I/O Board the regulated 5 volts supplies power to the CPU / Sound Board, Gas Plasma (Dot Matrix) Display and Plasma (Display) Controller Board. Power for these devices comes off the I/O Board on [J16-(4-8)].

+5v, +20v, +50v, +18v, & +12v LED Indicators:

These DC voltages are derived on the I/O Board by rectification and filtering. Each has a **LED** indicating that power is being supplied to each of these voltage sources. The **-12v** supply comes from the same transformer winding as the **+12v** thus it does not have a **LED** indicator.

**** Note that the +50v & +20v power sources are turned off by the Interlock Switches when the Coin Door is OPEN.**

LED	SUPPLY VOLTAGE
L2	+5
L200	+20v
L201	+50v
L202	+18v
L203	+12v

Reset Circuitry:

The I/O will reset in three (3) cases:

1. The CPU is in reset. The CPU's reset signal is fed into the I/O through connector **J1** and forces the I/O into reset.
2. The 5v supply has fallen below 4.75v.
3. The watchdog is not being fed by the scanning of the light matrix. More specifically **Pin-19** of **U6** must be toggling once every **50ms** to prevent the watchdog from resetting. The scanning of the light matrix is controlled by the CPU through **J1**.

LED L204 shows the reset state of the I/O Board. If this **LED** is not lit either the 5v DC is below 4.75v or the CPU/Sound Board is holding the I/O in reset. If the **LED** is flashing this means that the watchdog is not being feed by the CPU/Sound Board and the I/O is oscillating into and out of reset. If the **LED** is continuously on the board is out of reset and communication from the CPU to the lamp matrix is confirmed. Testpoint Blanking is the actual reset signal on the I/O Board. A low voltage indicates that it is in reset this will turn off all Solenoid (Coil) Drivers, Flash Lamps, Lamp Matrix Drivers, Auxiliary Outputs and Flipper Outputs. A high voltage indicates that it is out of reset and normal operation can take place.

Address Decoding:

All Address decoding is done by two **74LS138's** (**U204 & U205**) (3 of 8 decoder). Both of these must be in operation for the I/O Board to function properly.

Solenoid (Coil) Drivers & Flash Lamps:

J8 & J9 are high side drivers for driving solenoids and other heavy loads. Each connector has its own buffer driving 8 drivers. **J8 & J9** consist of **MOSFET Drivers 20N10L** which can easily & safely be tested by clipping one end of a clip-lead to test point **FET TPL1** and then the other to the corresponding gate resistor **R1-R16** (see *Note 1*). This will apply 3.4v to the gate of the **MOSFET Transistor** thus switching it on. **J7 & J6** each are a bank of 8 low side driver for driving lamps or other lower current solenoids (coils). They use a Bipolar Power Transistor **TIP122** which can also be tested by using **TEST POINT TIP TPL3** and the corresponding resistors **R17-R32*** (see *Note 1*).

Note 1 • Clip on the resistor side with the white stripe. •• R1 controls Q1, R2 controls Q2, et cetera...

Auxiliary In & Out:

J2-8 CMOS Outputs sometimes used for a printer interface.

J3-8 CMOS Inputs general purpose inputs.

Lamp Matrix:

J12 has 10 low side drivers for the lamp strobes which consist of **19N06L MOSFETS**. Only one lamp strobe should be low at any time. Again the scanning of the lamp strobes keeps the I/O from resetting. **J13** has 8 high side drivers with each having a status indicator. All the status indicators are logically 'OR'ed together and fed back to the CPU/Sound Board. The status can identify open loads (for example open lamp filaments or intermittent connections) and short circuits. These drivers are also short-circuit protected.

General Illumination (G.I.) Lights:

J15 has 6v AC switched on & off by a relay on the I/O Board. The relay is controlled by **Q200** which supplies power to the 24v coil winding to activate the relay. There are 4 taps on **J15** each fused at 5A for this 6v AC source.

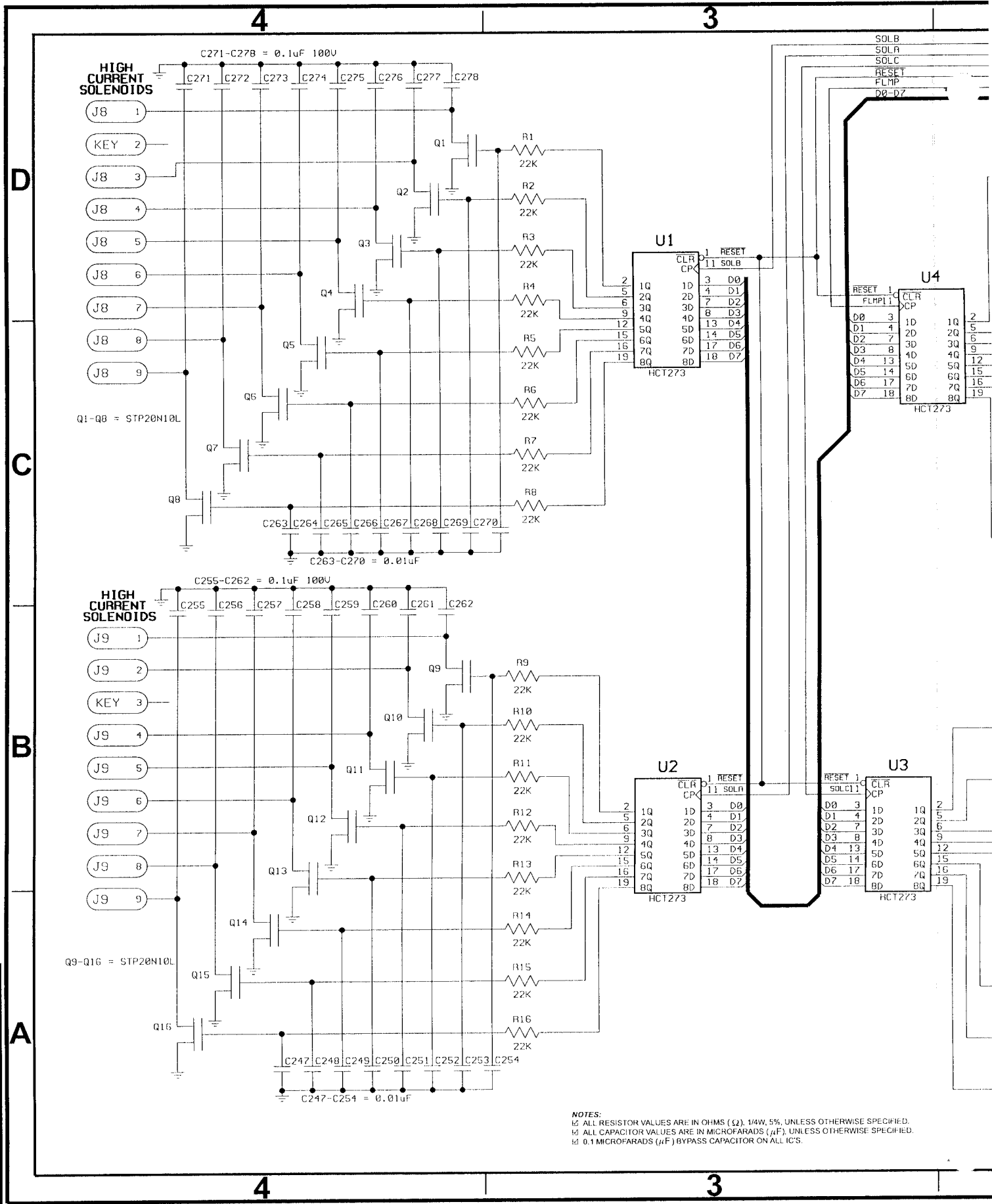

NOTES:
 1. ALL RESISTOR VALUES ARE IN OHMS (Ω), 1/4W, 5%, UNLESS OTHERWISE SPECIFIED.
 2. ALL CAPACITOR VALUES ARE IN MICROFARADS (μ F), UNLESS OTHERWISE SPECIFIED.
 3. 0.1 MICROFARADS (μ F) BYPASS CAPACITOR ON ALL IC'S.

Sec. 5: PCBs



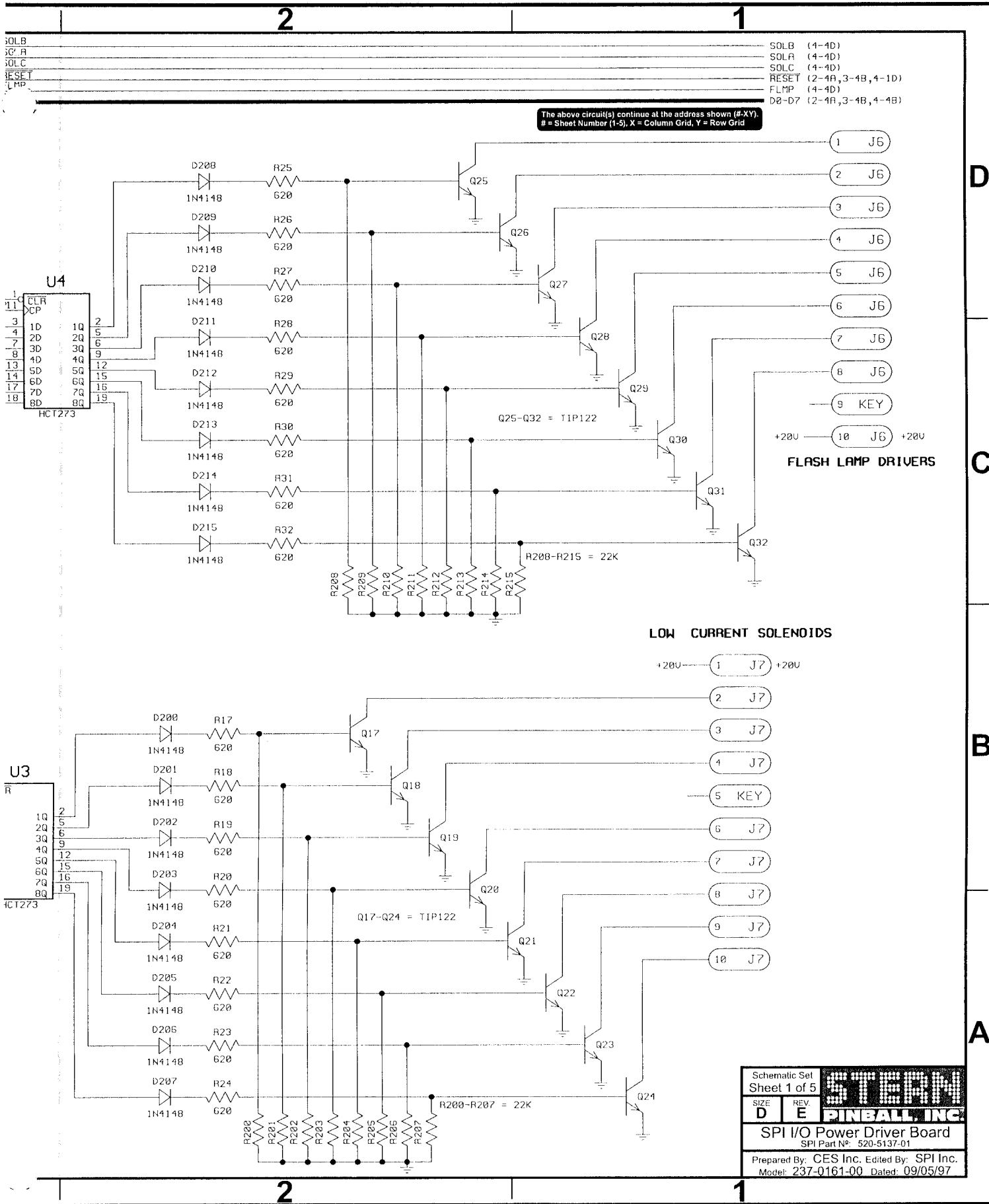

Schematic Set		STEM	
Sheet 1 of 5			
SIZE	REV.	PINBALL, INC.	
D	E	SPI I/O Power Driver Board	
SPI Part No: 520-5137-01			
Prepared By: CES Inc. Edited By: SPI Inc.			
Model: 237-0161-00 Dated: 09/05/97			



Sec. 5: PCBs

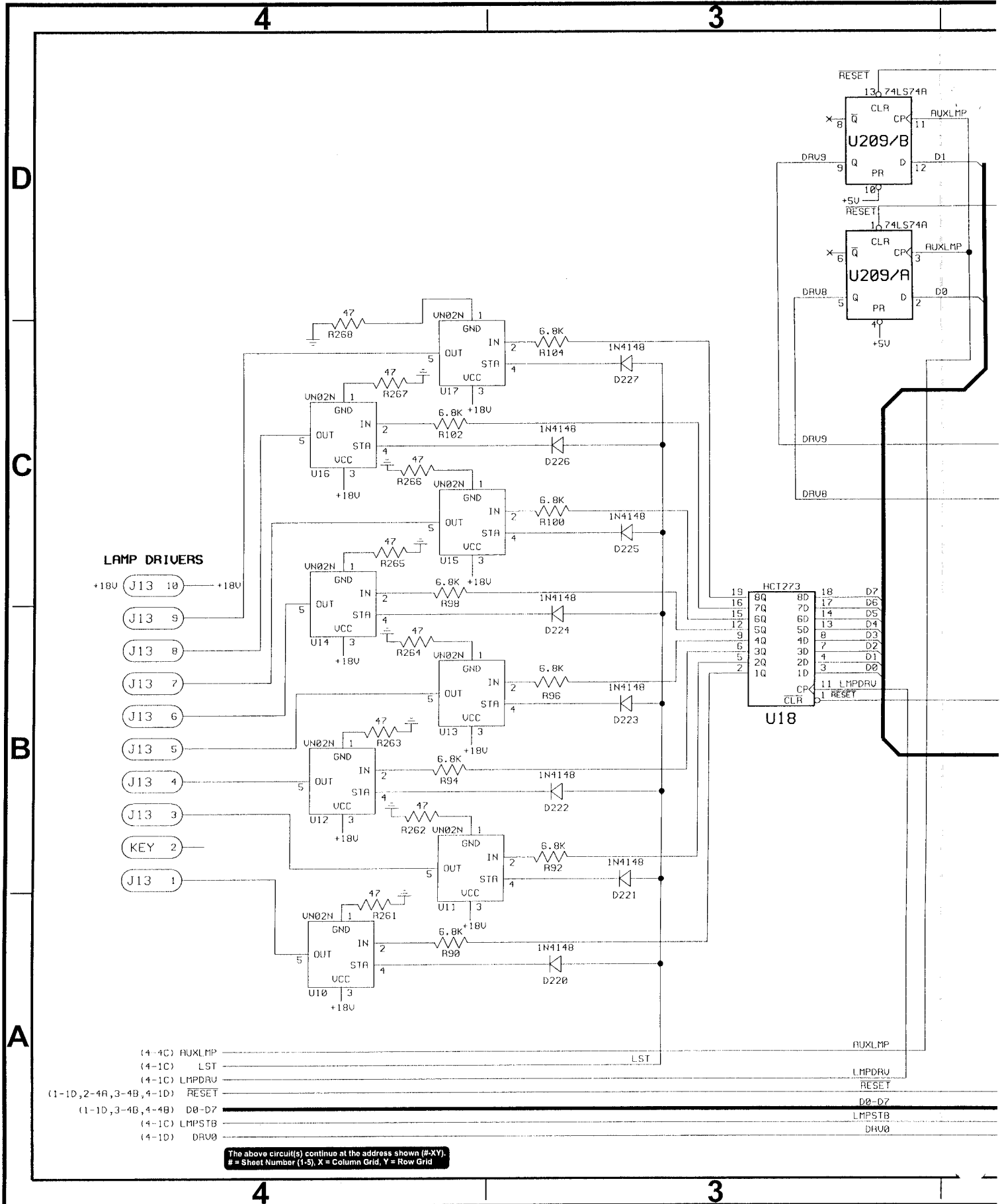

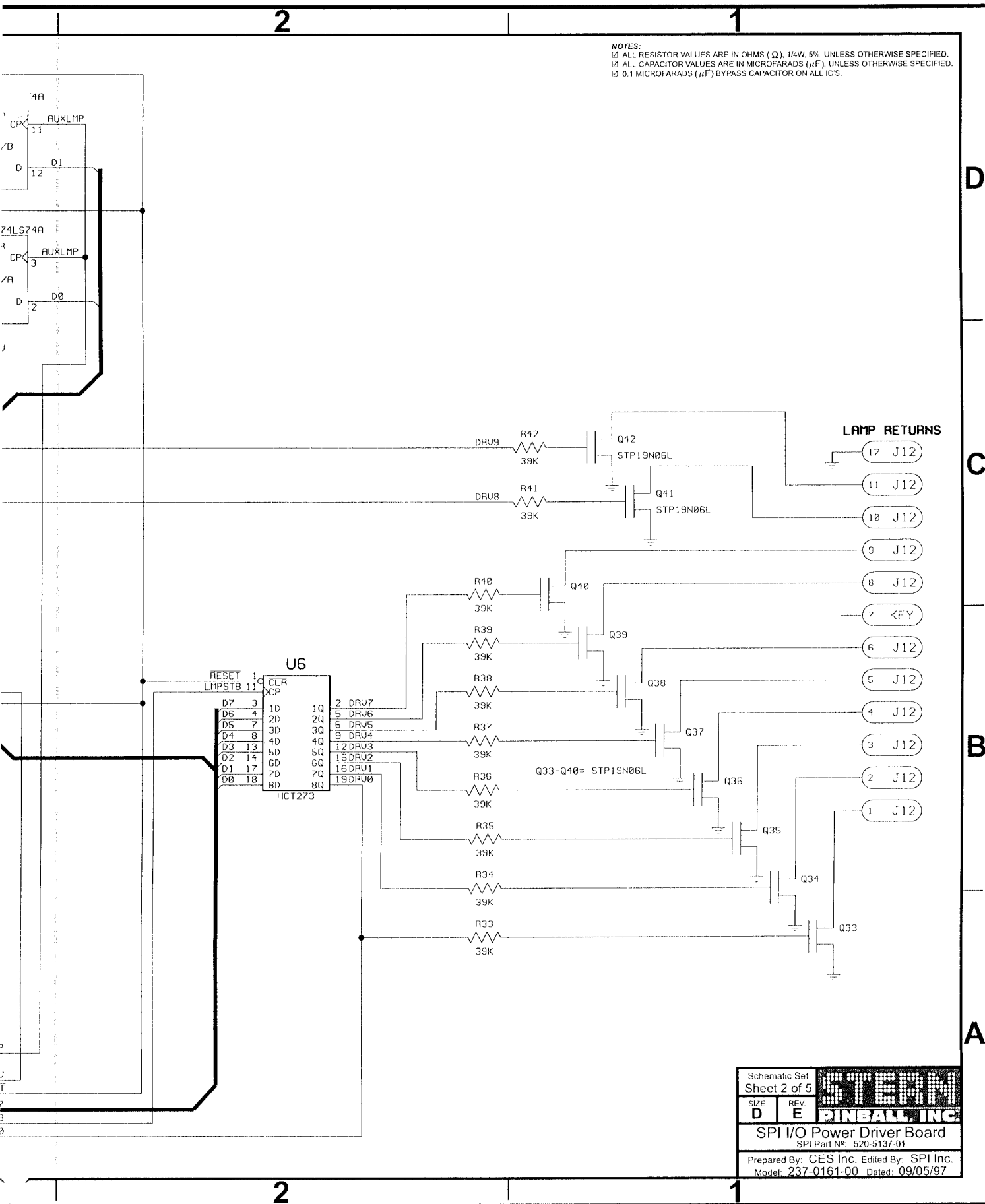

Schematic Set		STEM
Sheet 2 of 5		
SIZE	REV	PINBALL, INC.
D	E	
SPI I/O Power Driver Board		
SPI Part No: 520-5137-01		
Prepared By: CES Inc. Edited By: SPI Inc.		
Model: 237-0161-00 Dated: 09/05/97		

Sec. 5: PCBs



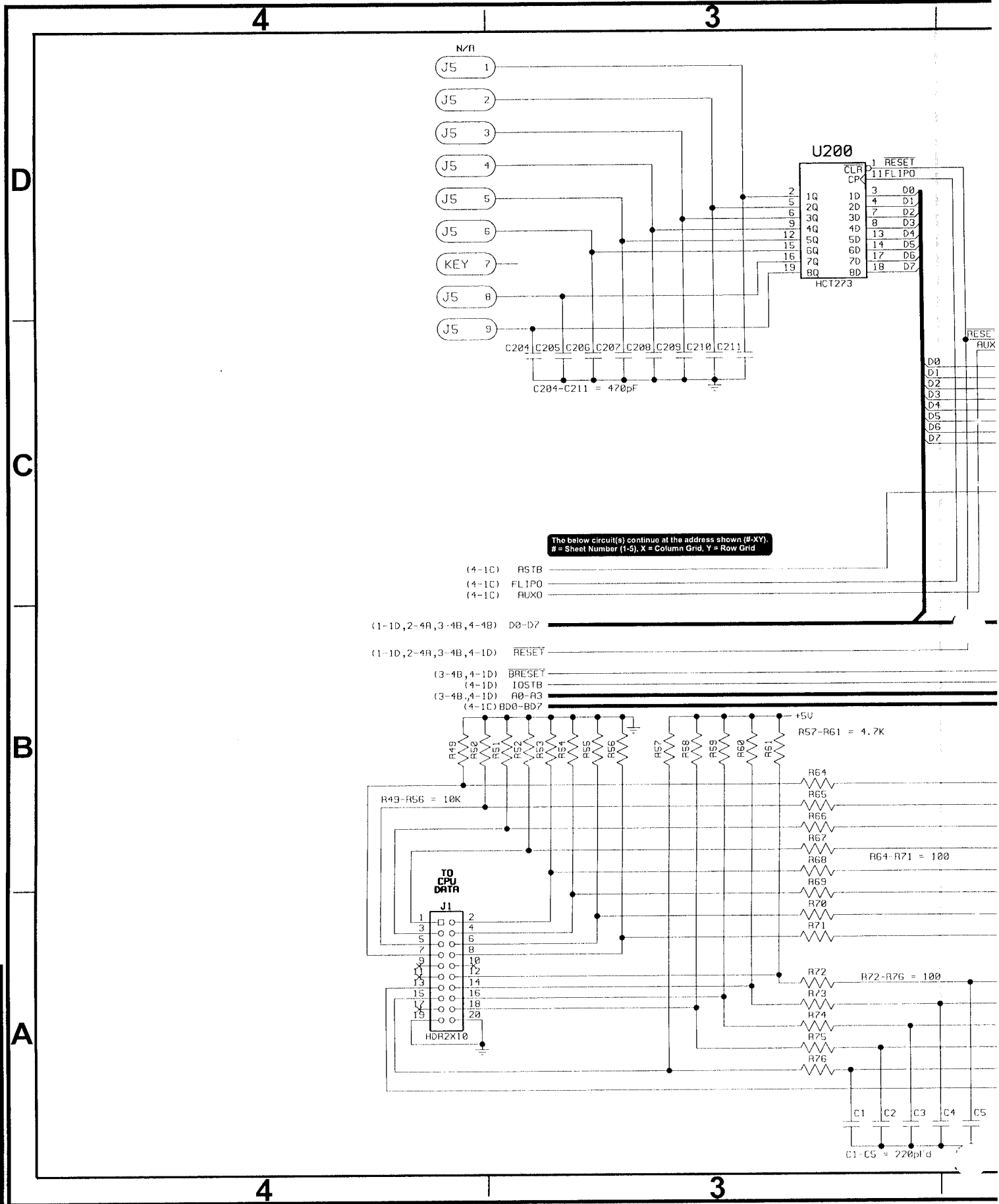

The below circuit(s) continue at the address shown (#-XY).
 #- Sheet Number (1-3), X = Column Grid, Y = Row Grid

- (4-1C) R5TB
- (4-1C) FLIPO
- (4-1C) AUX0

(1-1D, 2-4A, 3-4B, 4-4B) D0-D7

(1-1D, 2-4A, 3-4B, 4-1D) RESE

- (3-4B, 4-1D) BRESE
- (4-1D) IOSTB
- (3-4B, 4-1D) A0-A3
- (4-1C) BD0-BD7

Sec. 5: PCBs



2

1

NOTES:
 ✓ ALL RESISTOR VALUES ARE IN OHMS (Ω), 1/4W, 5%, UNLESS OTHERWISE SPECIFIED.
 ✓ ALL CAPACITOR VALUES ARE IN MICROFARADS (μF), UNLESS OTHERWISE SPECIFIED.
 ✓ 0.1 MICROFARADS (μF) BYPASS CAPACITOR ON ALL IC'S.

DATE	DESCRIPTION OF CHANGES / REVISIONS	REQ.	BY.
JAN 2001	Cut trace on solder side at Aux. Out Port J2-PIN1 thru J2-PIN3 & J2-PIN5 thru J2-PIN9; Soldered Resistor 100Ω 1/4W 5% (SPI N#: 121-5007-00). This Modification (highlighted below at J2 with a dotted-line box) was accomplished on boards produced after Jan. 1, 2001. This board is backwards compatible for the White Star™ Board System.	TS	JET

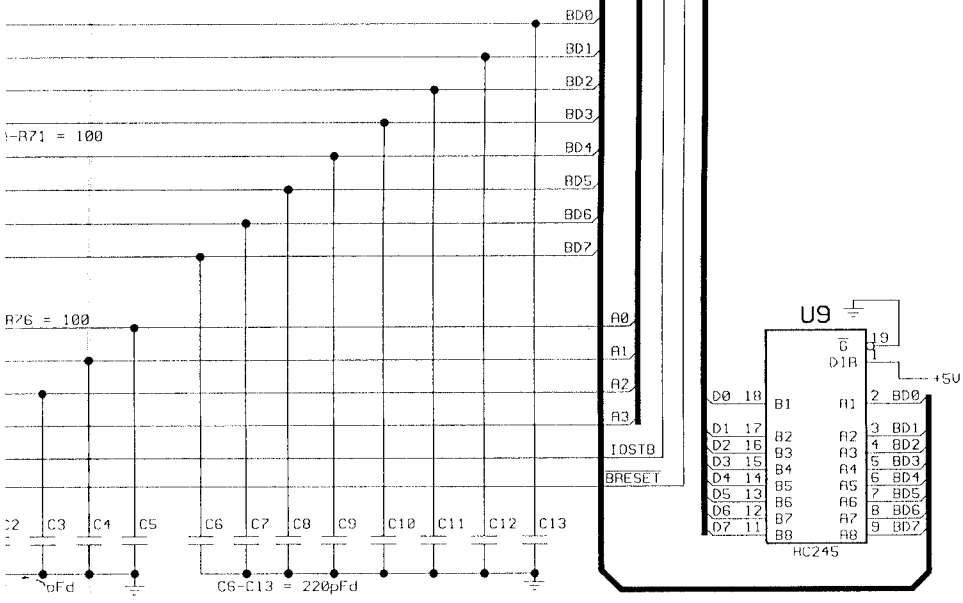
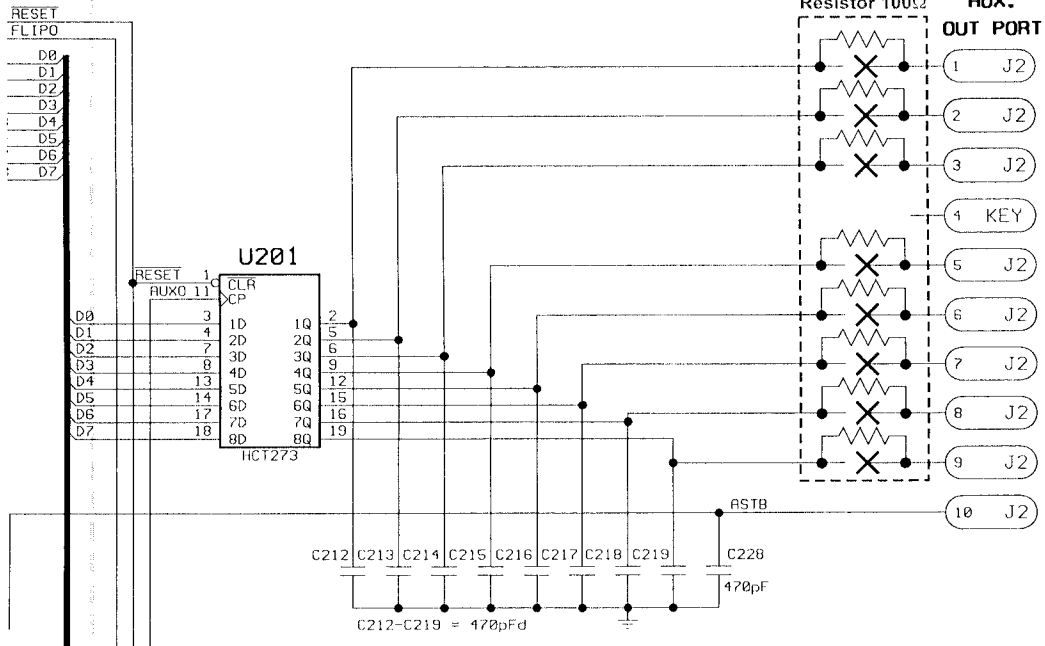

2

1

Schematic Set		STEM
Sheet 3 of 5		
SIZE	REV.	PINBALL, INC.
D	E	
SPI I/O Power Driver Board		
SPI Part N#: 520-5137-01		
Prepared By: CES Inc. Edited By: SPI Inc.		
Model: 237-0161-00 Dated: 09/05/97		

D

C

B

A

Sec. 5: PCBs



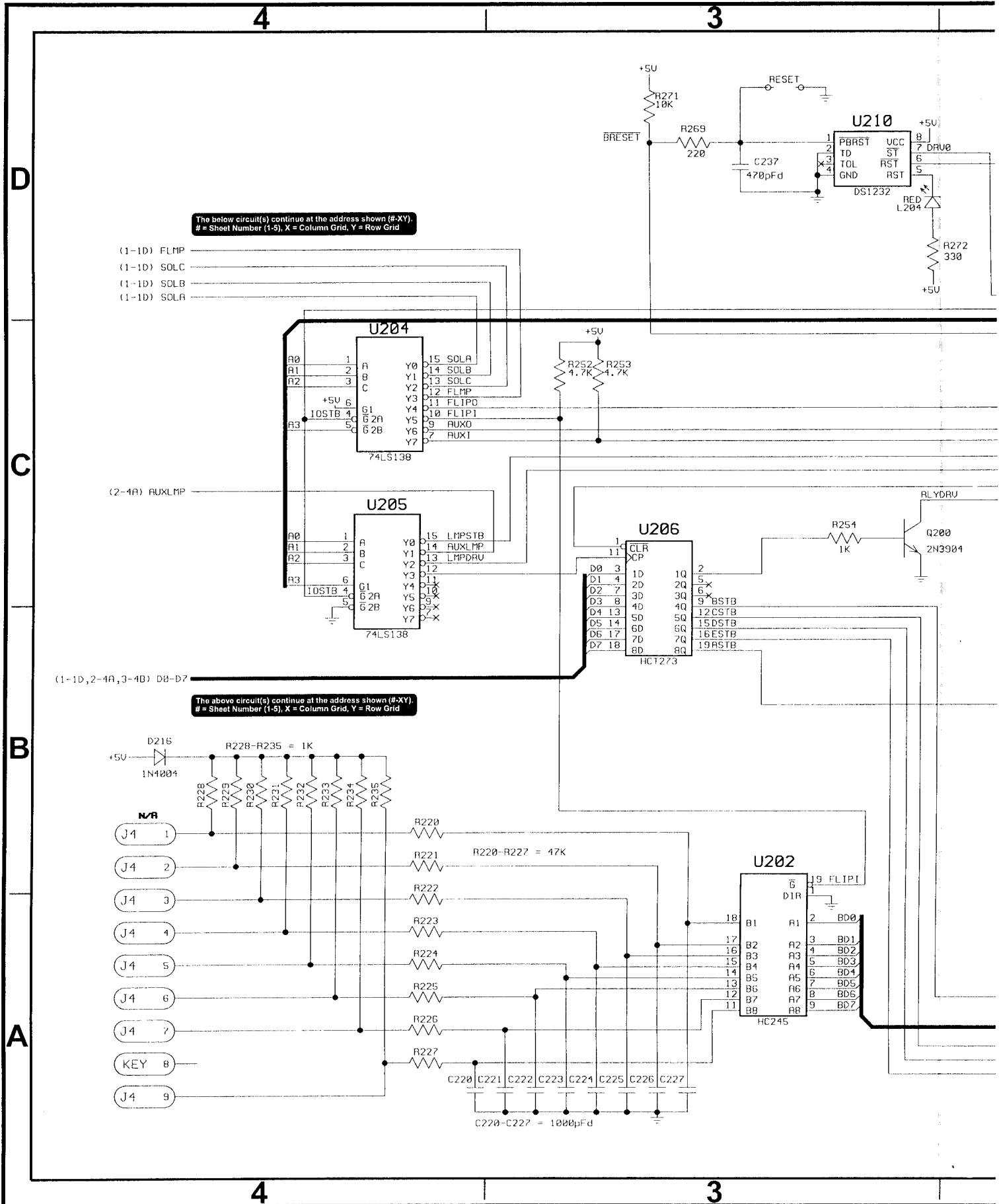

The below circuit(s) continue at the address shown (#-XY).
= Sheet Number (1-5), X = Column Grid, Y = Row Grid

- (1-1D) FLMP
- (1-1D) SOLC
- (1-1D) SOLB
- (1-1D) SOLA

The above circuit(s) continue at the address shown (#-XY).
= Sheet Number (1-5), X = Column Grid, Y = Row Grid

- (1-1D, 2-4A, 3-4B) D0-D7



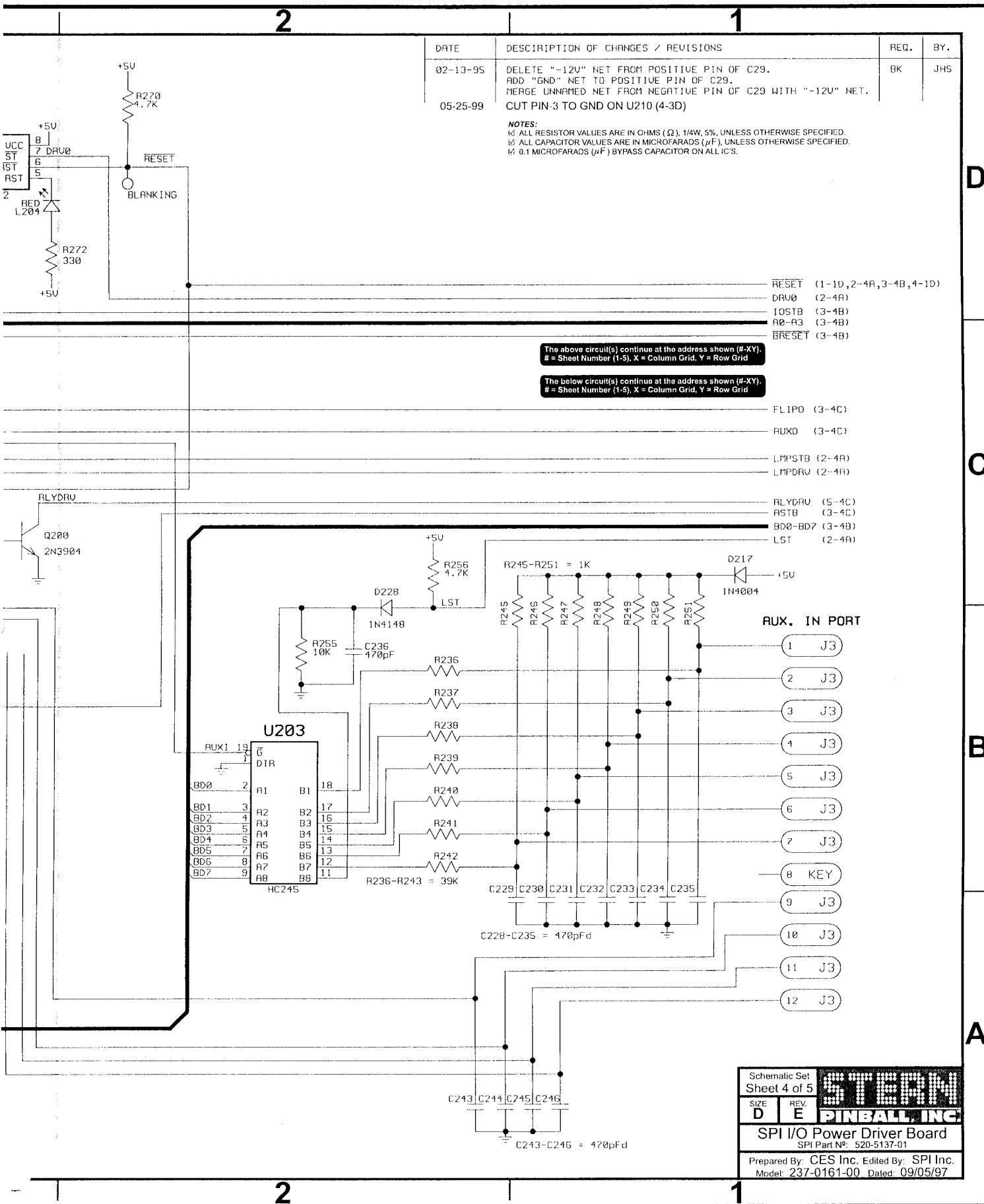

Schematic Set
 Sheet 4 of 5

STEM
PINBALL, INC.

SPI I/O Power Driver Board
 SPI Part No: 520-5137-01

Prepared By: CES Inc. Edited By: SPI Inc.
 Model: 237-0161-00 Dated: 09/05/97

Sec. 5: PCBs



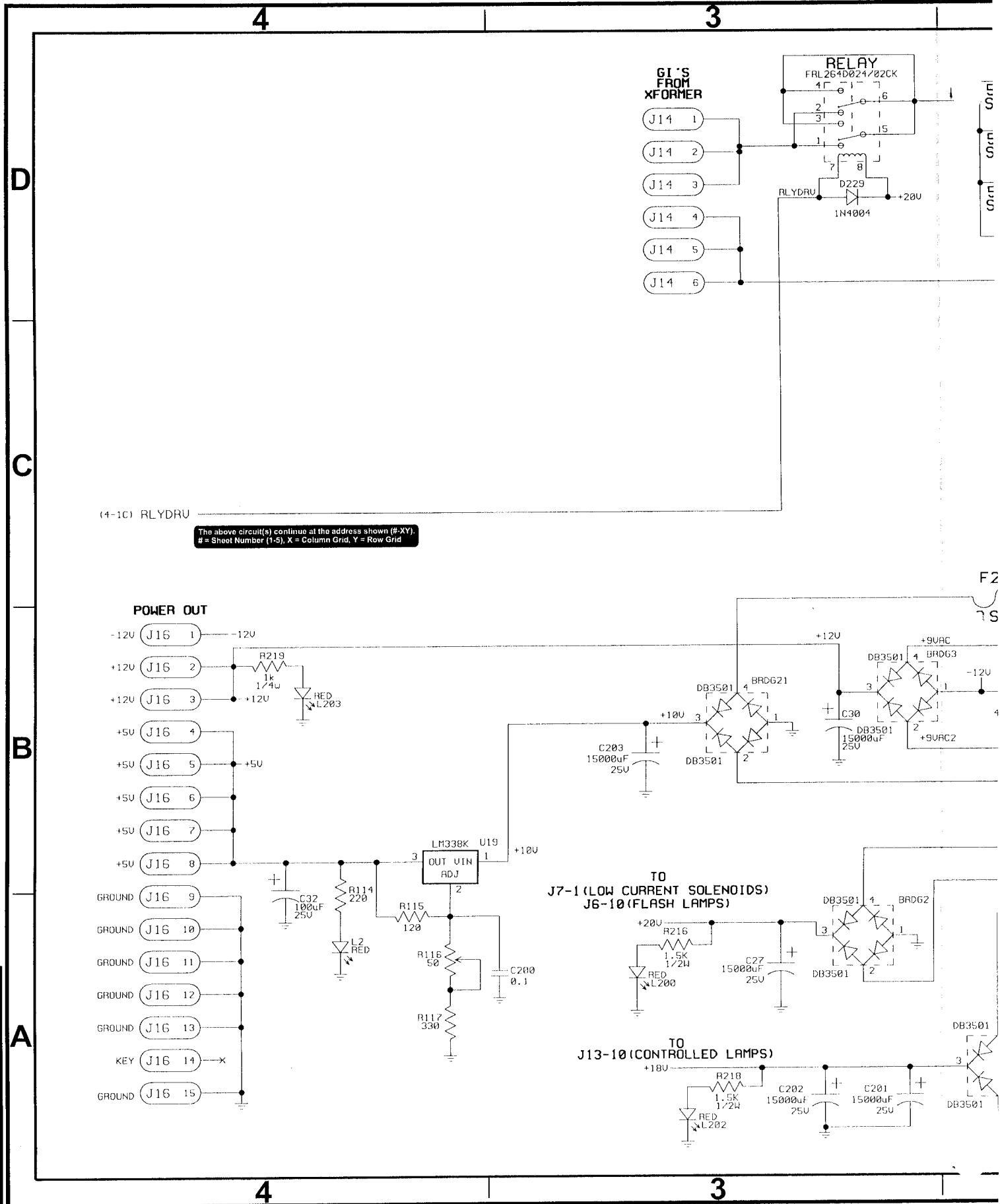

Sec. 5: PCBs

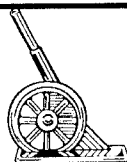

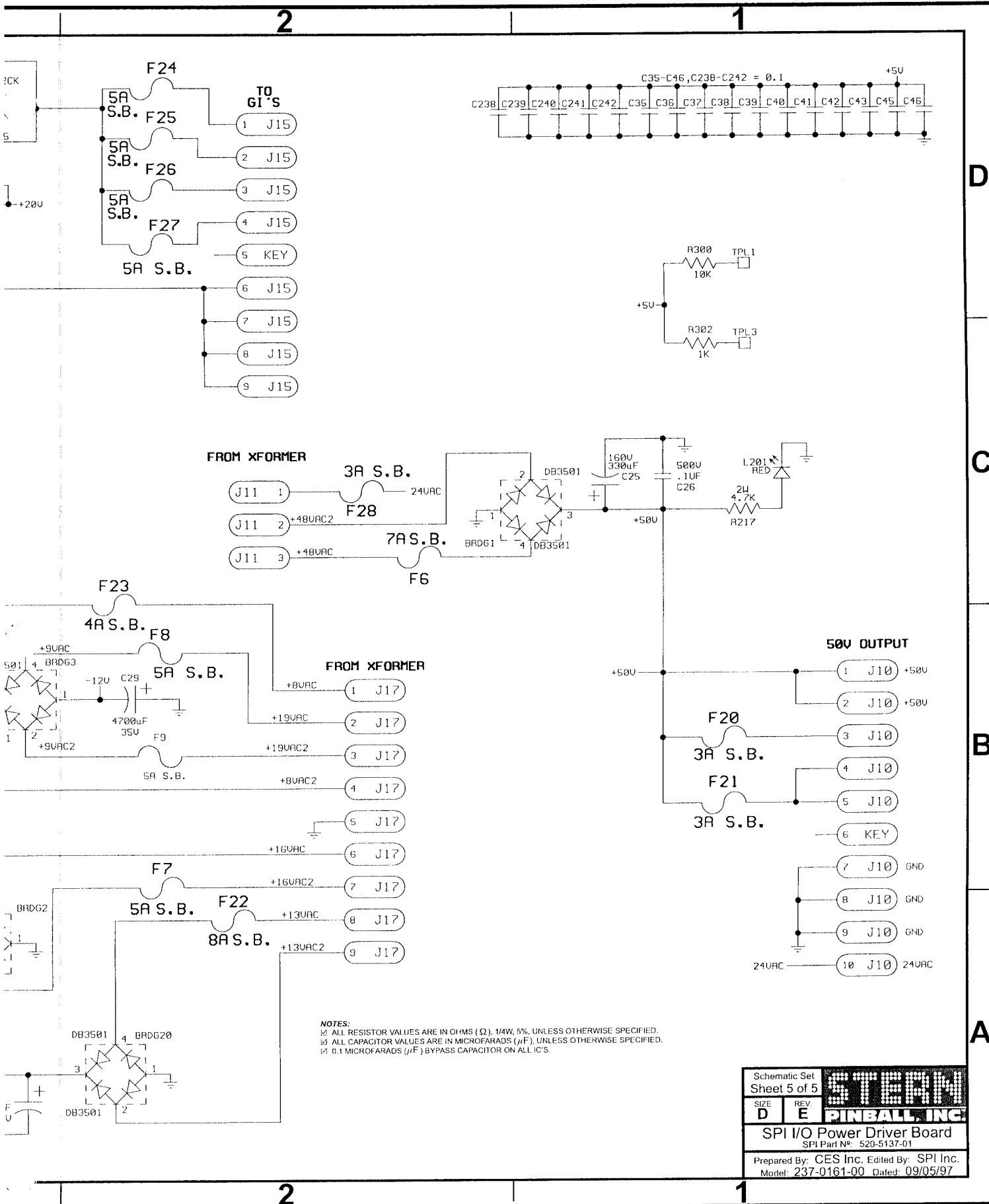

NOTES:
 1. ALL RESISTOR VALUES ARE IN OHMS (Ω), 1/4W, 5%, UNLESS OTHERWISE SPECIFIED.
 2. ALL CAPACITOR VALUES ARE IN MICROFARADS (μ F), UNLESS OTHERWISE SPECIFIED.
 3. 0.1 MICROFARADS (μ F) BYPASS CAPACITOR ON ALL IC'S.

Schematic Set		STEM
Sheet 5 of 5		
SIZE	REV	PINBALL, INC.
D	E	
SPI I/O Power Driver Board		
SPI Part N ^o : 520-5137-01		
Prepared By: GES Inc. Edited By: SPI Inc.		
Model: 237-0161-00 Dated: 09/05/97		

Sec. 5: PCBs



I/O Power Driver Board Component Layout

Test Points:



Sec. 5: PCBs

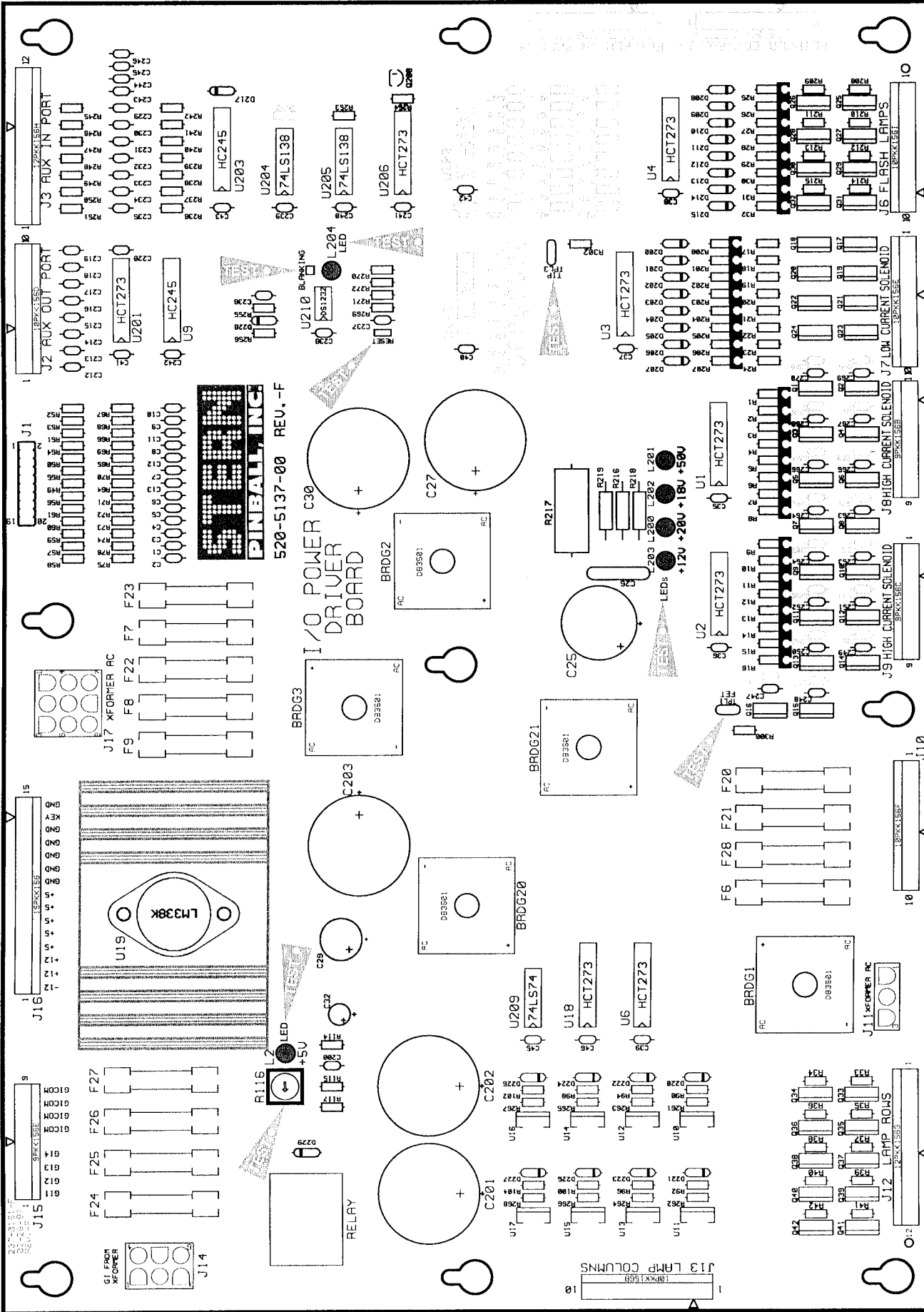

- ← TIP TPL3
- ← BLANKING
- ← L204 LED
- ← RESET

- LEDs :
- ← L201 +50v
 - ← L202 +18v
 - ← L200 +20v
 - ← L203 +12v

← FET TPL1

- LED :
- ← L2 +5V
 - ← R116 POT

Actual Board Size 15.698" X 11"



I/O Power Driver Board Parts

ITEM	QTY	PART NUMBER	REF-DESIGNATOR	DESCRIPTION (NS = Not Stuffed)
—	1	520-5137-01	I/O Power Driver Board	Complete PCB Assembly
01	5	112-5000-00	BRDG1, BRDG2, BRDG3, BRDG20, BRDG21	DB3501
02	13	125-5030-00	C1, C2, C3>C6, C7, C8, C9>C10, C11, C12	220pF (221), Cap.
03	1	125-5033-00	C25	100uF, 150v, Radial Lytic Cap.
04	1	125-5035-00	C26	.1uF 500v, Ceramic Disk Cap.
05	5	125-5036-00	C27, C30, C201, C202, C203	15000uF, 25v, Radial Lytic Cap.
06	1	125-5034-00	C29	4700uF, 35v, Radial Lytic Cap.
07	1	125-5032-00	C32	100uF, 25v, Radial Lytic Cap.
08	17	125-5031-00	C35, C36, C37, C38, C39, C40, C41, C42, C43, C45, C46, C200, C238, C239, C240, C241, C242	0.1uF, (104), Cap.
09	22	125-5028-00	C212>C219, C228>C237, C243>C246	470pF, (471), Axial Cap.
11	16	125-5029-00	C247>C254, C263>C270	0.01uF, (103), 100v Cap.
13	25	112-0054-00	D200>D207, D208>D215, D220, D221, D222, D223, D224, D225, D226, D227	1N4148, Diode
14	2	112-5003-00	D217, D229	1N4004, Diode
15	26	205-0004-00	F6, F7, F8, F9, F20, F21, F22, F23, F24> F27, F28	Fuse Clips
16	1	200-5000-03	F6	7A 250v S.B. Fuse
17	7	200-5000-01	F7, F8, F9, F24>F27	5A 250v S.B. Fuse
18	3	200-5000-08	F21, F20, F28	3A 250v S.B. Fuse
19	1	200-5000-05	F22	8A 250v S.B. Fuse
20	1	200-5000-06	F23	4A 250v S.B. Fuse
21	1	045-5015-01	J1	20-Pin, 0.1 Dual Row Header
22	1	045-5014-01	J2 (Key Pin-4), J6 (Key Pin-9), J7 (Key Pin-5) J10 (Key Pin-6), J13 (Key Pin-2)	10PKK156
23	1	045-5015-00	J3 (Key Pin-8)	12PKK156
24	1	045-5013-00	J8 (Key Pin-2), J9 (Key Pin-3), J15 (Key Pin-5)	9PKK156
25	1	045-0014-03	J11	10-84-4030 (3-Pin MOLEX)
26	1	045-5015-00	J12 (Key Pin-7)	12PKK156
27	1	045-0014-06	J14	10-84-4060 (6-Pin MOLEX)
28	1	045-5016-00	J16 (Key Pin-14)	15PKK156
29	1	045-0014-09	J17	10-84-4090 (9-Pin MOLEX)
30	6	165-5099-00	L2, L200, L201, L202, L203, L204	LED T1-3/4 DIFFUSER LED
31	16	110-0106-00	Q1>Q16	22NE10L STP, Transistor
32	16	110-0067-00	Q17>Q24, Q25>Q32	TIP122
33	10	110-0088-00	Q33>Q42	19N06L STP, Transistor
34	1	110-0069-00	Q200	2N3904, Transistor.
35	32	121-5042-00	R1>R8, R9>R16, R200>R207, R208>R215	22K Ω 1/4W Res.
36	16	121-5003-00	R17>R24, R25>R32	620 Ω 1/4W Res.
37	17	121-5045-00	R33>R42, R236>R242	39K Ω 1/4W Res.
38	8	121-5021-00	R49, R57>R61, R253, R256, R270	4.7K Ω 1/4W Res.
39	11	121-5011-00	R50>R56, R255, R271, R300	10K Ω 1/4W Res.
40	13	121-5007-00	R64>R76	100 Ω 1/4W Res.
			Resistors on Solder Side @ J2-Pins: 1-3 & 5-9	
41	8	121-5029-00	R90, R92, R94, R96, R98, R100, R102, R104	6.8K Ω 1/4W Res.
42	2	121-5033-00	R114, R269	220 Ω 1/4W Res.
43	1	121-5030-00	R115	120 Ω 1/4W Res.
44	1	121-5039-00	R116	50 Ω Pot
45	2	121-5036-00	R117, R272	330 Ω 1/4W Res.
46	2	121-5038-00	R216, R218	1.5K Ω 1/2W Res.
47	1	121-5050-00	R217	4.7K Ω 2W Res. (SANDBAR)
48	1	121-5009-00	R219	1K Ω 1/4W Res.
50	9	121-5009-00	R245>R251, R254, R302	1K Ω 1/4W Res.
51	8	121-5032-00	R261, R262, R263, R264, R265, R266, R267, R268	47K Ω 1/4W Res.
52	1	190-5002-00	RELAY	FRL264D024/02CK Relay
53	2	n/a	TPL1, TPL3	Test Point Wire (24ga.) Loops
54	8	100-5012-00	U1, U2, U3, U4, U6, U18, U201, U206	74HCT273
55	1	110-0058-00	U9	74LS245
56	1	100-5023-00	U210	DS1232
57	8	110-0089-00	U10, U11, U12, U13, U14, U15, U16, U17	VN02N
58	1	100-0356-00	U19	LM338K
59	1	n/a	U19	Heatsink (5v Reg.)
60	1	100-0338-00	U203	74HC245
61	2	100-0148-00	U204, U205	74LS138
62	1	100-0037-00	U209	74LS74
63	1	n/a	BLANKING, RESET	Test Points



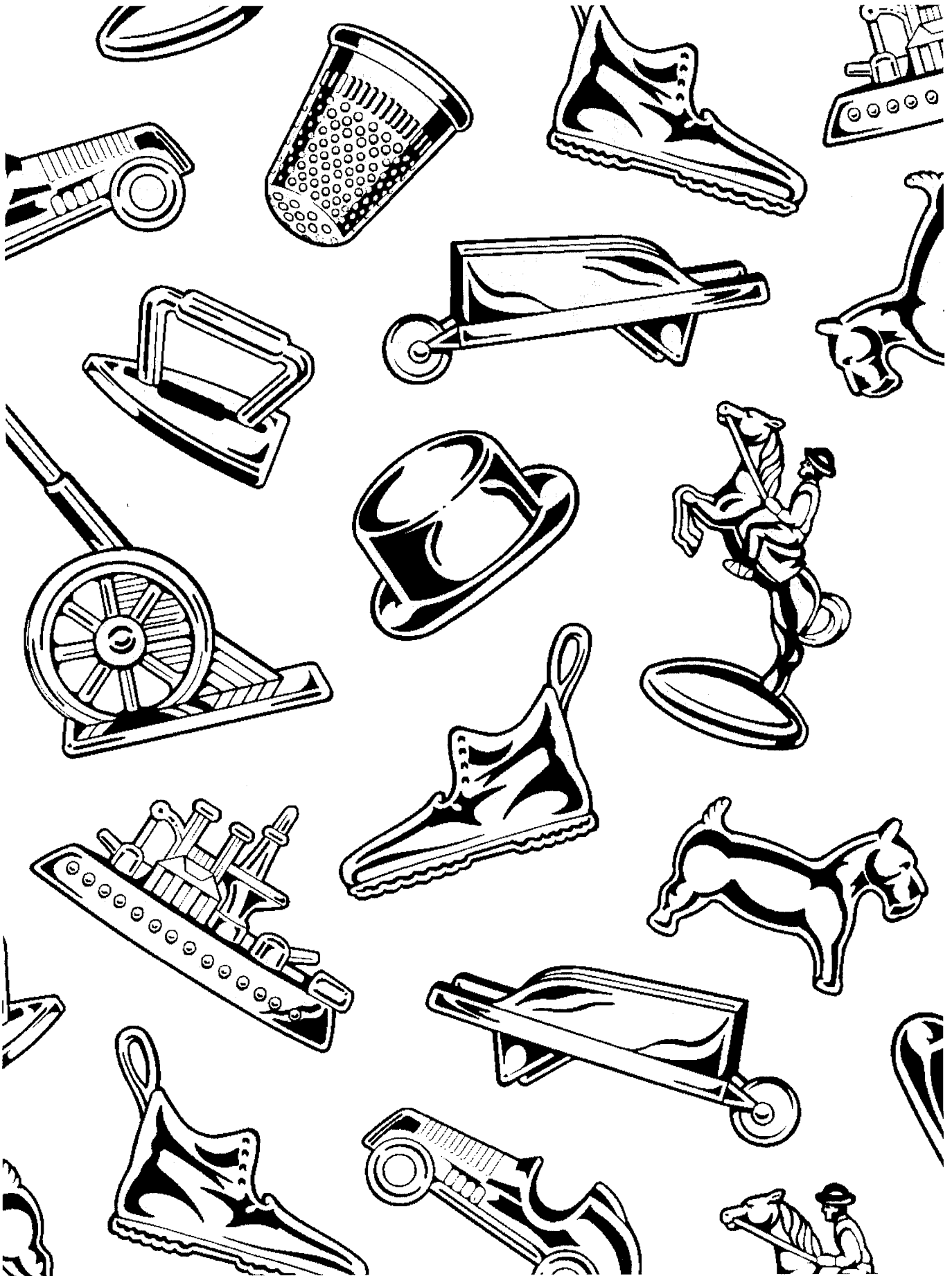

CPU/Sound Board Theory of Operation

CPU Section:

The CPU is a **68B09E (U209)** with up to 8 MBytes of CPU *Code Space (U210)*. The CPU code is bank selected by the use of **U211** and each bank consists of 16 KBytes. 8 KBytes of **RAM (U212)** is available to the CPU. The RAM is battery backed and has a write protected area. Battery back up is accomplished by **3-AA Cells (BAT1)** which have a **TEST POINT VBATT** to check the battery voltage status. The write protected area consists of 512 Bytes used for storing game settings. This section of **RAM** can only be written to when the coin door is open. The Coin Door switch comes into the CPU on **CN6-12** and is fed into the address decoding **PAL U213**. When this memory protect signal is low writes to the protected **RAM** area are prohibited. Address decoding for the system is accomplished by one **PAL U213** and one 1-of-8 decoder **U214**.

A watchdog is used to monitor the CPU and the 5v supply. If the 5v supply is below 4.75 the watchdog will hold the CPU/Sound Board & I/O Board in *reset*. The watchdog must be fed at a rate of **250ms** or faster. The signal used to feed the watchdog comes from the EPROM Bank select signal used to load **U211**. The CPU has a timer interrupt used as a heartbeat for the system this signal comes from counter **U2**. The clock for this counter is the **CPU Q CLOCK**. Clearing the timer interrupt is done by reading the **DIP Switch**. The timer interrupt can be observed at **TEST POINT FIRQ**. In normal operation "**FIRQ**" should be toggling at a rate of **976Hz**.

The I/O Interface **CN1** is buffered by two (2) **HC245** Chips (**U207 & U208**). The CPU's reset line is buffered by **Q10** and fed over to the I/O through **CN1**. An I/O *Strobe Signal* is fed through **CN1-15** and is used to notify the I/O that a valid address is being sent.

Switches:

The Switch Matrix consists of eight (8) **2N3904** Transistors(**Q1-Q8**) which pull one of 8 strobes 'low' to *activate* a Single Column of switches. The *Switch Return Signals* are fed into **CN7** [SWITCH ROWS] and are highly filtered and compared to a 2.5v *reference voltage*. The *Switch Return Voltage* must be below 2.5v to make a *Valid Switch Closure*. If *false switches* are appearing, check that none of the **2N3904** Transistors are permanently pulling the *strobe line low*. Only one strobe from **CN5** [SWITCH COLUMNS] should be *low at any time*. **CN6** [DEDICATED SWITCH IN] is a *Dedicated Bank of Input Switches*. Switches connected to **CN6** are connected to ground instead of a strobe and may be read at any time.

Plasma Interface:

The data path for communication to and from the Plasma Controller Board is 8 bits wide. There are separate *Input* and *Output Busses*. The *Input Bus* from the Plasma Controller to the CPU/Sound Board comes in on **CN8** [PLASMA CONTROL]-Pins **3-10** and is fed into **U200** for input to the CPU's *Data Bus*. Data going out to the controller comes from the CPU's *Data Bus* through **U201** and onto **CN8-Pins 11-18**. Status back from the Plasma Controller comes in on **CN8-Pins 22-26** and is fed into **U202** for input to the CPU's *Data Bus*. Two control signals that go out to the Plasma Controller are **PRES** [PLASMA RESET] and **CN8-Pin 19** [**PSTB** - *Plasma Strobe*]. The Plasma Reset is software controllable through **U216/B** and also has a test point "Plasma Reset". The *Plasma Strobe Signal* to the controller is generated from **U216/A** and is *used to latch data* into the Plasma Controller.

Sound Section:

The audio section consists of a **BSMT SOUND CHIP U9** Sound (Voice) EPROMs (**U17 U21 U36 U37**) **68B09E U6** and Sound Code EPROM **U7**. The **BSMT** latches sound EPROM addresses in **U13 & U12** for output to the Sound EPROMs. Sound Data from the EPROMs is read through **U19** to the **BSMT**. The EPROMs are bank selected by **U22**. When the **BSMT** has sound data to be played out to the speakers it loads 16 bits into a 16 bit shift register made up of **U24 & U23**. The data stream from the shift register is serially shifted into a stereo 16 bit *Digital to Analog Converter (DAC, U26)*. When the system is operating properly the *ws* (word select) input of the **DAC** will be toggling. The *ws* input is used to latch the right and left channel sound data into the **DAC**. If the *ws* line is not oscillating no analog signal will come out of the **DAC**. The **DAC** outputs are a controlled current source. These outputs are converted to a voltage by an operational amplifier **U30** to form the analog signal. **TEST POINTS AOR** and **AOL** are the outputs of the operational amplifier. These outputs are then fed directly into the power amplifiers (**TDA2030A**) or optionally into an analog volume control chip **U35** for a potentiometer volume control. The analog section has its own +5v & -5v derived from **VR1 & VR2**. These separate supply voltages are for the **DAC U26** Operational Amplifier **U30** and analog volume control **U35**.

Sound calls are made from the CPU's **68B09E U209** to the sound section by latching data into **U5**. The sound section's **CPU 68B09E (U6)** reads in this data and handles the interfacing to the **BSMT**.

Other Test Points:

E & Q - The CPU signals for both **68B09E** processors. Should be at 2Mhz with **Q** leading **E** by **500 nsec**.

24Mhz - The oscillator used for the **BSMT** & derivation of **E & Q**.

SND-FIRQ - The sound sections **CPU Interrupt**.

6Mhz - This clock is generated internally on the **BSMT** and is used for shifting the data samples into the **DAC**.

W6 Jumper - This jumper must be installed for games that use **8MB** Sound EPROMs (**U17 U21 U36 U37**). For games which use **4MB** Sound EPROMs this jumper is not installed but will operate on boards with **W6** installed.

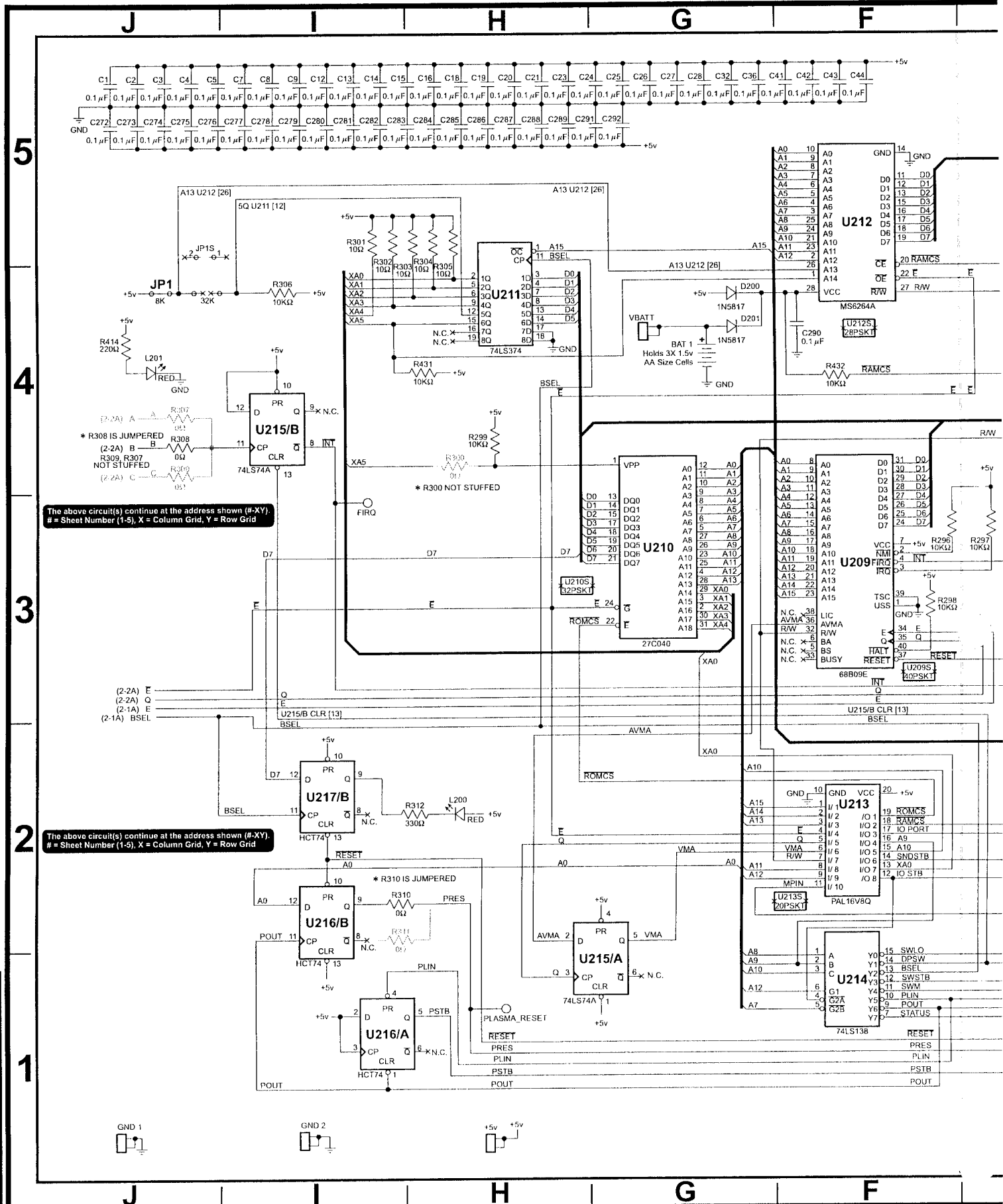

The above circuit(s) continue at the address shown (#-XY).
 # = Sheet Number (1-5), X = Column Grid, Y = Row Grid

The above circuit(s) continue at the address shown (#-XY).
 # = Sheet Number (1-5), X = Column Grid, Y = Row Grid

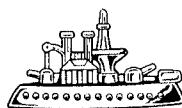

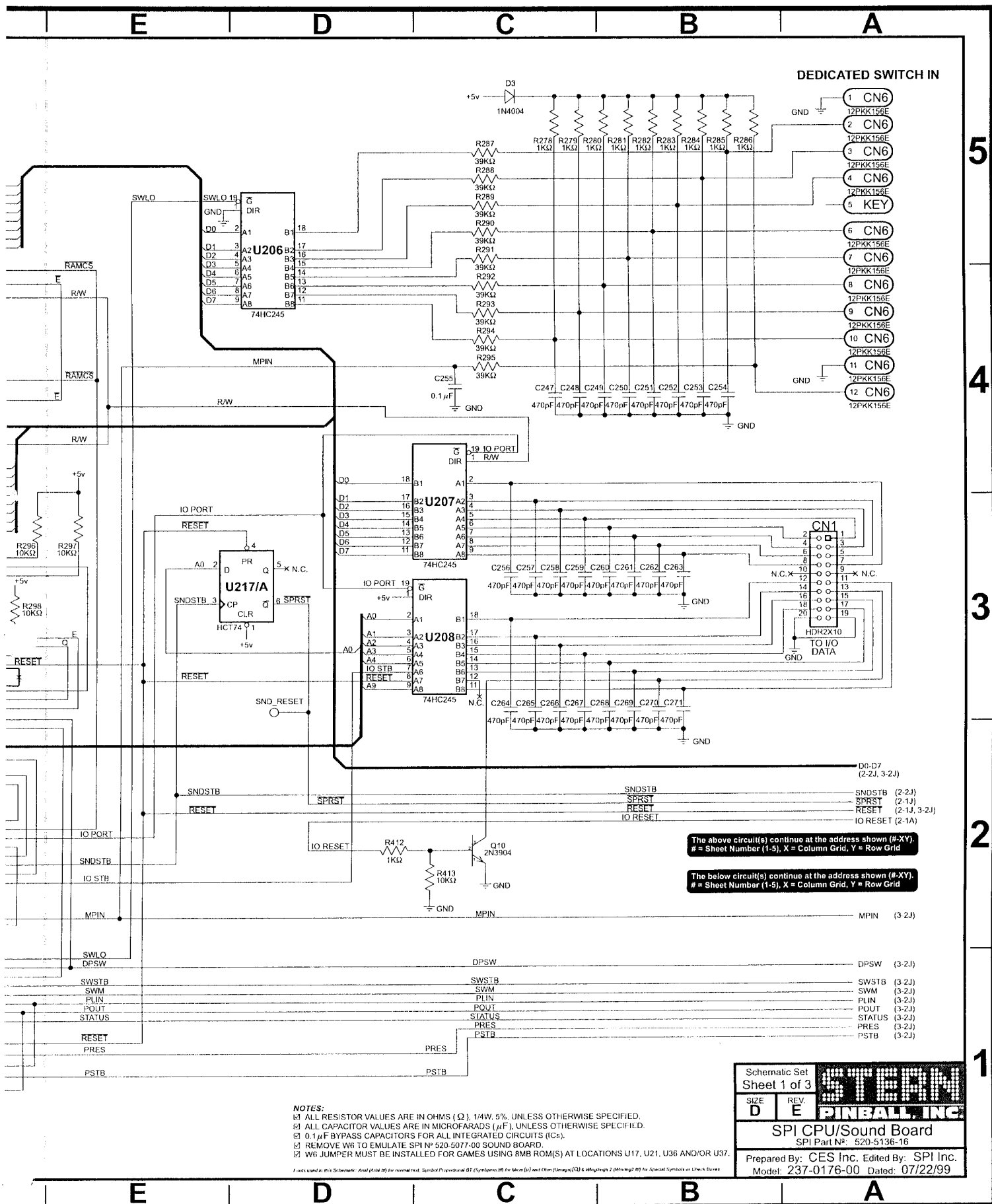

The above circuit(s) continue at the address shown (#-XY):
 # = Sheet Number (1-5), X = Column Grid, Y = Row Grid

The below circuit(s) continue at the address shown (#-XY):
 # = Sheet Number (1-5), X = Column Grid, Y = Row Grid

NOTES:

- ALL RESISTOR VALUES ARE IN OHMS (Ω), 1/4W, 5%, UNLESS OTHERWISE SPECIFIED.
- ALL CAPACITOR VALUES ARE IN MICROFARADS (μF), UNLESS OTHERWISE SPECIFIED.
- 0.1 μF BYPASS CAPACITORS FOR ALL INTEGRATED CIRCUITS (ICs).
- REMOVE W6 TO EMULATE SPI # 520-5077-00 SOUND BOARD.
- W6 JUMPER MUST BE INSTALLED FOR GAMES USING 8MB ROM(S) AT LOCATIONS U17, U21, U36 AND/OR U37.

Schematic Set		STEM
Sheet 1 of 3		
SIZE	REV	PINBALL, INC.
D	E	
SPI CPU/Sound Board		
SPI Part No: 520-5136-16		
Prepared By: CES Inc. Edited By: SPI Inc.		
Model: 237-0176-00 Dated: 07/22/99		



Sec. 5: PCBs

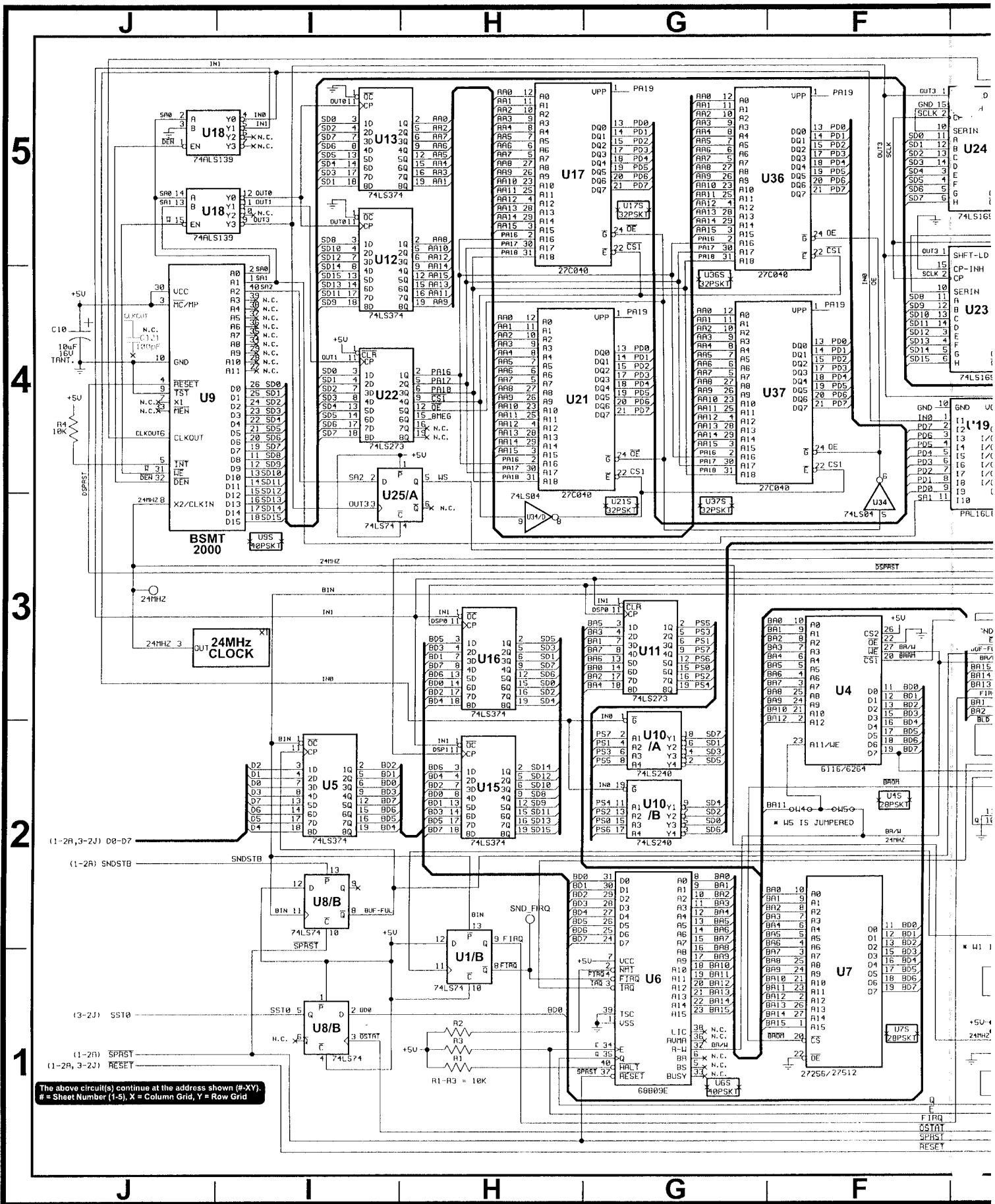

Sec. 5: PCBs

The above circuit(s) continue at the address shown (#-XY).
 # = Sheet Number (1-3), X = Column Grid, Y = Row Grid



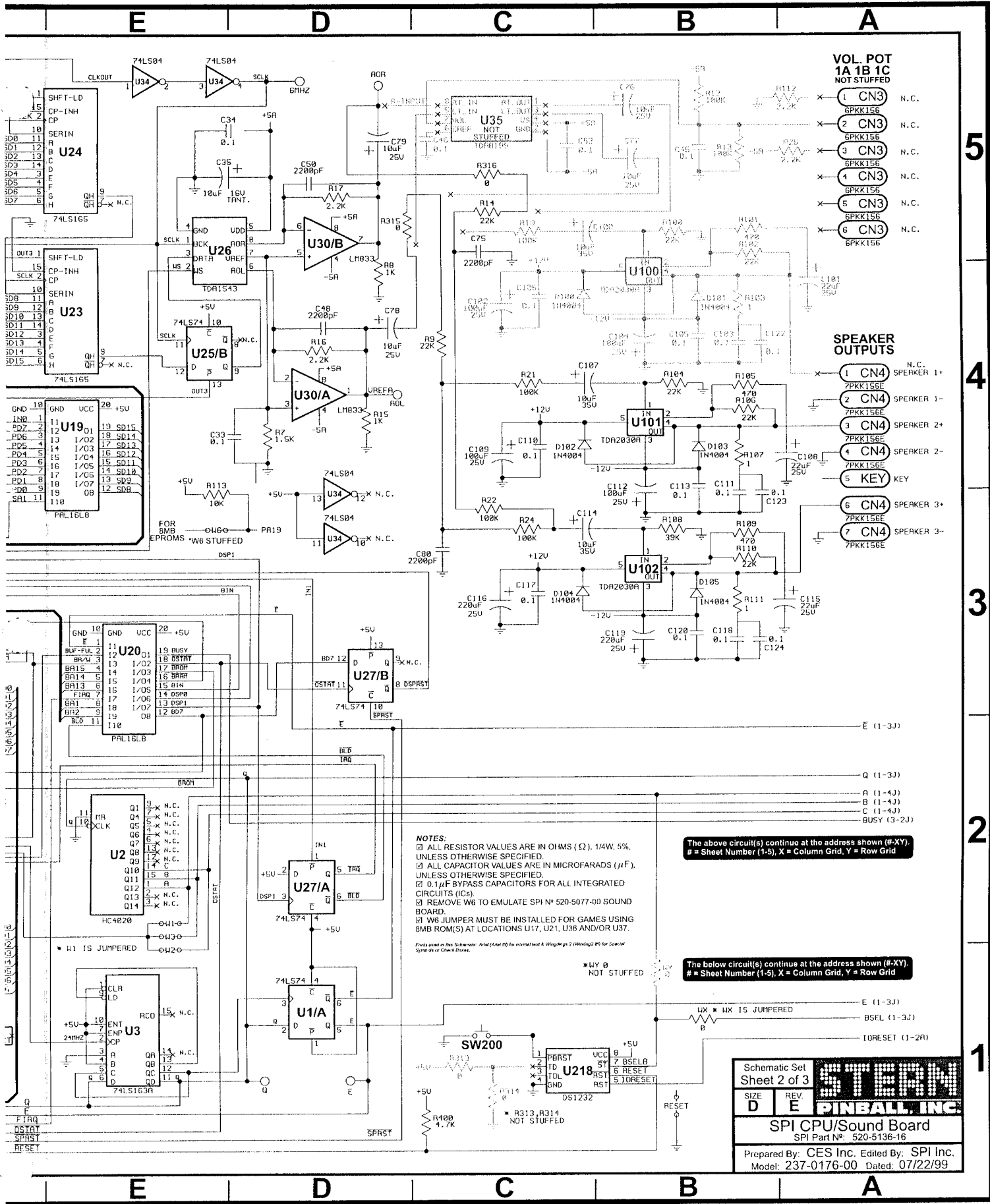

NOTES:
 1. ALL RESISTOR VALUES ARE IN OHMS (Ω), 1/4W, 5%, UNLESS OTHERWISE SPECIFIED.
 2. ALL CAPACITOR VALUES ARE IN MICROFARADS (μF), UNLESS OTHERWISE SPECIFIED.
 3. 0.1 μF BYPASS CAPACITORS FOR ALL INTEGRATED CIRCUITS (ICs).
 4. REMOVE W6 TO EMULATE SPI # 520-5077-00 SOUND BOARD.
 5. W6 JUMPER MUST BE INSTALLED FOR GAMES USING 8MB ROM(S) AT LOCATIONS U17, U21, U36 AND/OR U37.

The above circuit(s) continue at the address shown (#-XY).
 # = Sheet Number (1-5), X = Column Grid, Y = Row Grid

The below circuit(s) continue at the address shown (#-XY).
 # = Sheet Number (1-5), X = Column Grid, Y = Row Grid

Schematic Set		STERN
Sheet 2 of 3		
SIZE	REV.	PINBALL, INC.
D	E	
SPI CPU/Sound Board		
SPI Part No.: 520-5136-16		
Prepared By: CES Inc. Edited By: SPI Inc.		
Model: 237-0176-00 Dated: 07/22/99		



Sec. 5: PCBs

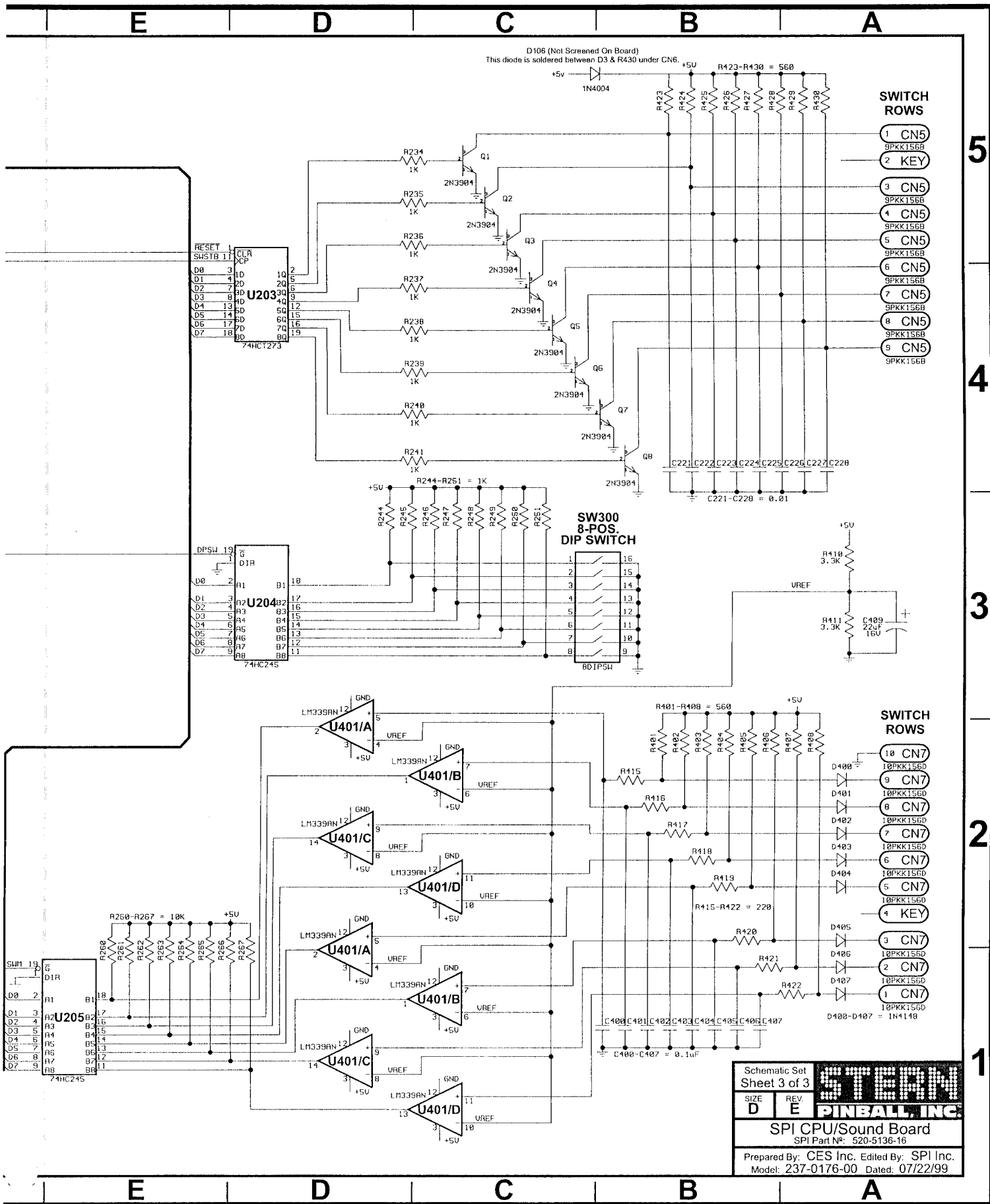

Schematic Set
Sheet 3 of 3

SIZE	REV.
D	E

STEARN
PINBALL INC.

SPI CPU/Sound Board
SPI Part No: 520-5136-16

Prepared By: CES Inc. Edited By: SPI Inc.
Model: 237-0176-00 Dated: 07/22/99

Sec. 5: PCBs



CPU/Sound Board Component Layout

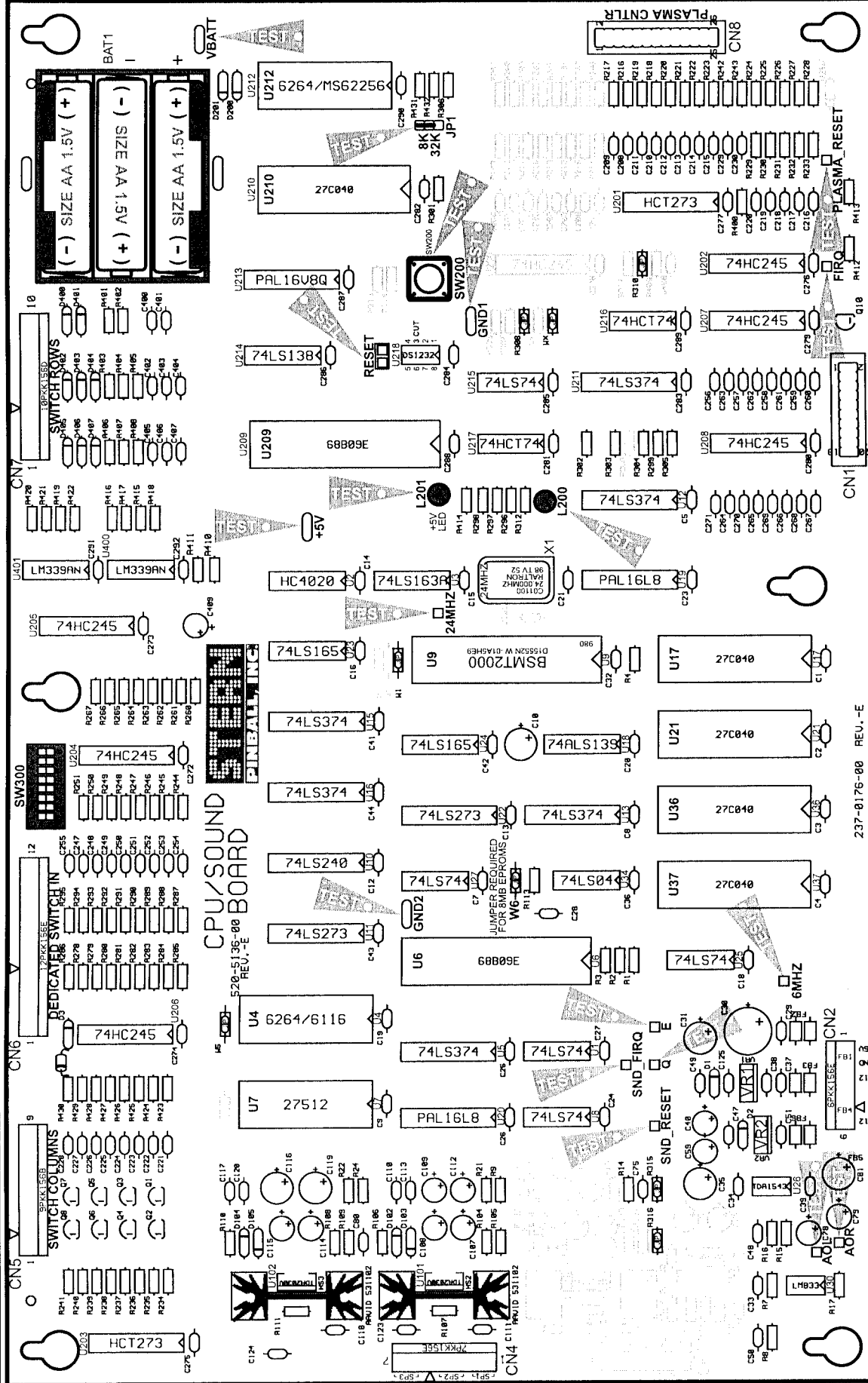

- Test Points:**
- ← VBATT
 - ← 8K/32K JUMPER JPI
 - ← PLASMA_RESET
 - ← FIRQ SW/200
 - ← GND1
 - ← RESET
 - LEDs :
 - ← L201+5v & L200
 - ← +5V
 - ← 24MHZ
 - ← 24MHZ
 - ← 6MHZ
 - ← E
 - ← SND_FIRQ & Q
 - ← SND_RESET
 - ← AOL & AOR
- REQUIRED FOR 8MB EPROM USE**
- ← W6 JUMPER
 - ← GND2
- 237-0176-00 REV.-E
- Actual Board Size
74.67" X 9.125"

Sec. 5: PCBs



CPU/Sound Board Parts

ITEM	QTY	PART NUMBER	REF-DESIGNATOR	DESCRIPTION (NS = Not Stuffed)
—	1	520-5136-64	CPU/Sound Board Mono (FCC FEB98)	Complete PCB Assembly
01	1	545-5685-00	BAT1 HOLDER (Always replace all 3, Size AA 1.5v Cells, with new ones, when required)	with new ones, when required)
02	79	125-5031-00	C1, C2, C3, C4, C5, C7, C8, C9, C12, C13, C14, C15, C16, C18, C19, C20, C21, C23, C24, C25, C26, C28, C32, C33, C34, C36, C38, C39, C111, C113, C117, C118, C120, C123, C124, C125, C255, C272, C273, C274, C275, C276, C277, C279, C280, C281, C282, C283, C284, C285, C286, C287, C288, C289, C290, C291, C292, C400>C401, C402>C404, C405>C407	0.1uF, (104), Axial Cer. Cap.
03	2	125-5017-00	C10, C35	10uF, 16v, Radial Tant. Cap.
04	3	125-5043-00	C29, C37, C51	0.001uF, (102), Cap.
05	1	125-5037-00	C30	1000uF, 16v, Radial Lytic Cap.
06	2	125-5019-00	C31, C81	470uF, 25v, Radial Lytic Cap.
07	4	125-5020-00	C40, C59, C108, C115 (C76, C77, C78 NS)	22uF, 25v, Radial Lytic Cap.
08	4	125-5039-00	C48, C50, C75, C80	0.0022uF, (222), Cap.
09	6	125-5017-00	C78, C79, C107, C114 (C110 NS)	10uF, 25v-35v, Radial Lytic Cap.
10	2	125-5015-00	C109, C112 (C102, C104 NS)	100uF, 25v, Rad. Ltc. Cap.
11	2	125-5012-00	C116, C119	220uF, 25v, Radial Lytic Cap.
13	44	125-5028-00	C208>C215, C216>C220, C229, C230, C247>C254, C256>C263, C264>C271 (C258>C267 NS)	470pF, (471), Cer. Cap.
14	8	125-5029-00	C221>C228 (C410 NS)	0.01uF, (103), 100v Cap.
15	1	125-5014-00	C409	22uF, 16v, Radial Lytic Cap.
16	1	045-5015-01	CN1	20-Pin, 0.1 HEADER
17	1	045-5015-06	CN2 (Key Pin-5) (C113 NS)	6PKK156
18	1	045-5015-07	CN4 (Key Pin-5)	7PKK156
19	1	045-5013-00	CN5 (Key Pin-2)	9PKK156
20	1	045-5015-00	CN6 (Key Pin-5)	12PKK156
21	1	045-5014-01	CN7 (Key Pin-4)	10PKK156
22	1	045-5015-26	CN8	26-Pin, 0.1 HEADER
23	7	112-5003-00	D1, D2, D3, D102, D103, D104, D105 (D110, D111 NS)	1N4004, Diode
24	2	112-5008-00	D200, D201	1N5817, Diode
25	8	112-0054-00	D400, D401, D402>D404, D405>D407 (D302 NS)	1N4148, Diode
26	6	n/a	(FB1)-FB2, FB3-(FB4), (FB5)-FB6	Ferrite Bead (if required, call Tech Support)
27	1	165-5099-00	L200, L201	LED T1-3/4 DIFFUSER LED
28	10	110-0069-00	Q1>Q8, Q10	2N3904, Transistor
29	36	121-5011-00	R1>R3, R4, R113, R224>R228, R244>R251, R260>R267, R296>R298, R299, R301, R302>R305, R306, R413, R431>R432	10K Ω 1/4W Res.
30	1	121-5018-00	R7	1.5K Ω 1/4W Res.
31	5	121-5023-00	R9, R14, R104, R106, R110 (R109 NS)	22K Ω 1/4W Res.
32	20	121-5009-00	R15, R8, R234>R241, R278>R286, R412	1K Ω 1/4W Res.
33	2	121-5043-00	R16, R17	2.2K Ω 1/4W Res.
34	3	121-5051-00	R21, R22, R24	100K Ω 1/4W Res.
35	2	121-5046-00	R105, R109	470K Ω 1/4W Res.
36	2	121-5009-00	R107, R111	1K Ω 1/4W Res.
37	9	121-5045-00	R108, R287>R294	39K Ω Res.
38	11	121-5021-00	R216>R223, R242, R243, R400	4.7K Ω 1/4W Res.
39	15	121-5033-00	R229>R233, R295, R414, R415>R422 (R240 NS)	220 Ω 1/4W Res.
40	5	n/a	R308, R310, R315>R316, WX	0 Ω Jumper Wire (24ga.)
41	1	121-5036-00	R312	330 Ω 1/4W Res.
42	16	121-5047-00	R401>R402, R403>R405, R406>R408, R423>R430	560 Ω 1/4W Res.
43	2	121-5048-00	R410, R411	3.3K Ω 1/4W Res.
44	1	n/a	SW200	B3F4000
45	1	181-5002-00	SW300	8-Pin, Dip Switch
46	5	100-0037-00	U1, U8, U25, U27, U215	74LS74
47	1	100-0249-00	U2	74HC4020
48	1	100-0049-00	U3	74LS163
49	1	105-0052-05	U4	6116 RAM
50	3	077-5208-00	U4, U7, U212	28-Pin, IC Dip Socket
51	6	100-0064-00	U5, U12, U13, U15, U16, U211	74LS374
52	1	100-0189-01	U6, U209	68B09E
53	3	077-5209-00	U6, U9, U209	40-Pin, IC Socket
54	1	(See Pg. DR. Table)	U7	27512 EPROM
55	1	105-0116-00	U9	BSMT2000
56	1	100-0149-00	U10	74LS240
57	5	(See Pg. DR. Table)	U17, U21, U36, U37, U210	27C040 EPROM
58	5	077-5217-00	U17, U21, U36, U37, U210	32-Pin, IC Socket
59	1	100-0043-00	U18	74ALS139
60	1	965-0136-00	U19 - YELLOW DOT	PAL16L8 (Programmed) YELLOW DOT
61	1	965-0137-00	U20 - WHITE DOT	PAL16L8 (Programmed) WHITE DOT
62	2	100-0022-00	U22, U11	74LS273
63	2	100-5008-00	U23, U24	74LS165
64	1	100-5018-00	U26	TDA1543
65	1	100-0375-00	U30	LM833
66	1	100-0027-00	U34	74LS04
67	1	100-5010-00	U35	74LS04
68	2	100-5016-20	U101, U102 (U103 NS)	TDA2030A
69	3	535-5000-10	U101 (HS2), U102 (HS3)	AAVID 531102 (Heat Sink)
70	2	100-5012-00	U201, U203	74HCT273
71	6	100-0338-00	U202, U204, U205, U206, U207, U208	74HC245
72	1	105-5046-00	U212	MS6264A
73	1	965-6504-00	U213 - BLUE DOT	PAL16L8 (Programmed) BLUE DOT
74	1	100-0148-00	U214	74LS138
75	2	100-5015-00	U216, U217	HCT74
76	1	100-5023-00	U218	DS1232
77	2	100-0377-00	U400, U401	LM339AN
78	4	n/a	VBATT, +5v, GND1, GND2	Test Point Wire (24ga.) Loops
79	1	124-5002-00	VR1	LM7905CT -5v Regulator
80	1	124-5001-00	VR2	LM7805CT +5v Regulator
81	6	n/a	W1, W5, W6* (for 8MB EPROMs)	0 Ω Jumper Wire (24ga.)
82	1	140-0011-00	X1	24Mhz
83	12	n/a	ADIR, AOL, SND_RESET, SND_FIRQ, Q. E, 6Mhz, 24Mhz, FIRQ, PLASMA_RESET, RESET (x2)	Test Points

Sec. 5: PCBs



4-Position OPTO (Trans. & Rec.) PC Boards Theory of Operation & Schematic

The following theory applies to circuit one (1) of four (4); apply the same logic to the other circuits, respectively.

The light falling on LED (L1) generates a voltage which is applied to the input (Pin-4) of the LM339 Comparator (U1). R1 bleeds off excess charge. Upon receiving .1 volt input from LED (L1), the Comparator (U1) then drives both the Switch Transistor (Q1) (during switch line strobcs) and the indicator LED (L5). If a switch line is being strobed, the emitter of Q1 drops to the saturation voltage of the Switch Line Driver, about .3 volts. This, plus the .7 volt drop on the base, gives a 1v forward bias voltage to Q1, so the current flows through the transistor during strobcs. This drives Q1 on and makes the switch. The normal state of the Switch Transistor Q1 is ON (N.C.) and the indicator LED (L5) is also ON. When the beam is blocked, then Q1 and LED (L5) are turned OFF.

520-5218-00 Transmitter

- L1 Trans. ↔ L4, L8 Rec.
- L2 Trans. ↔ L3, L7 Rec.
- L3 Trans. ↔ L2, L6 Rec.
- L4 Trans. ↔ L1, L5 Rec.

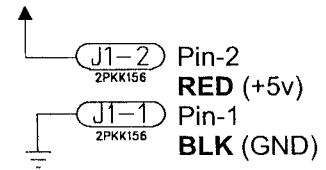
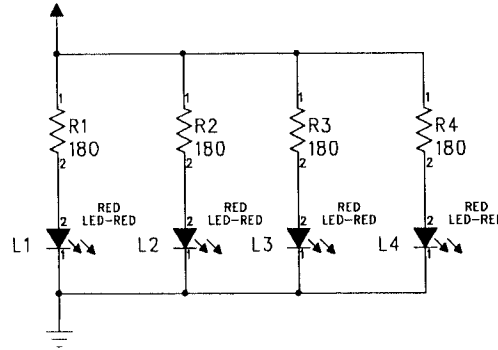

520-5210-00 Receiver

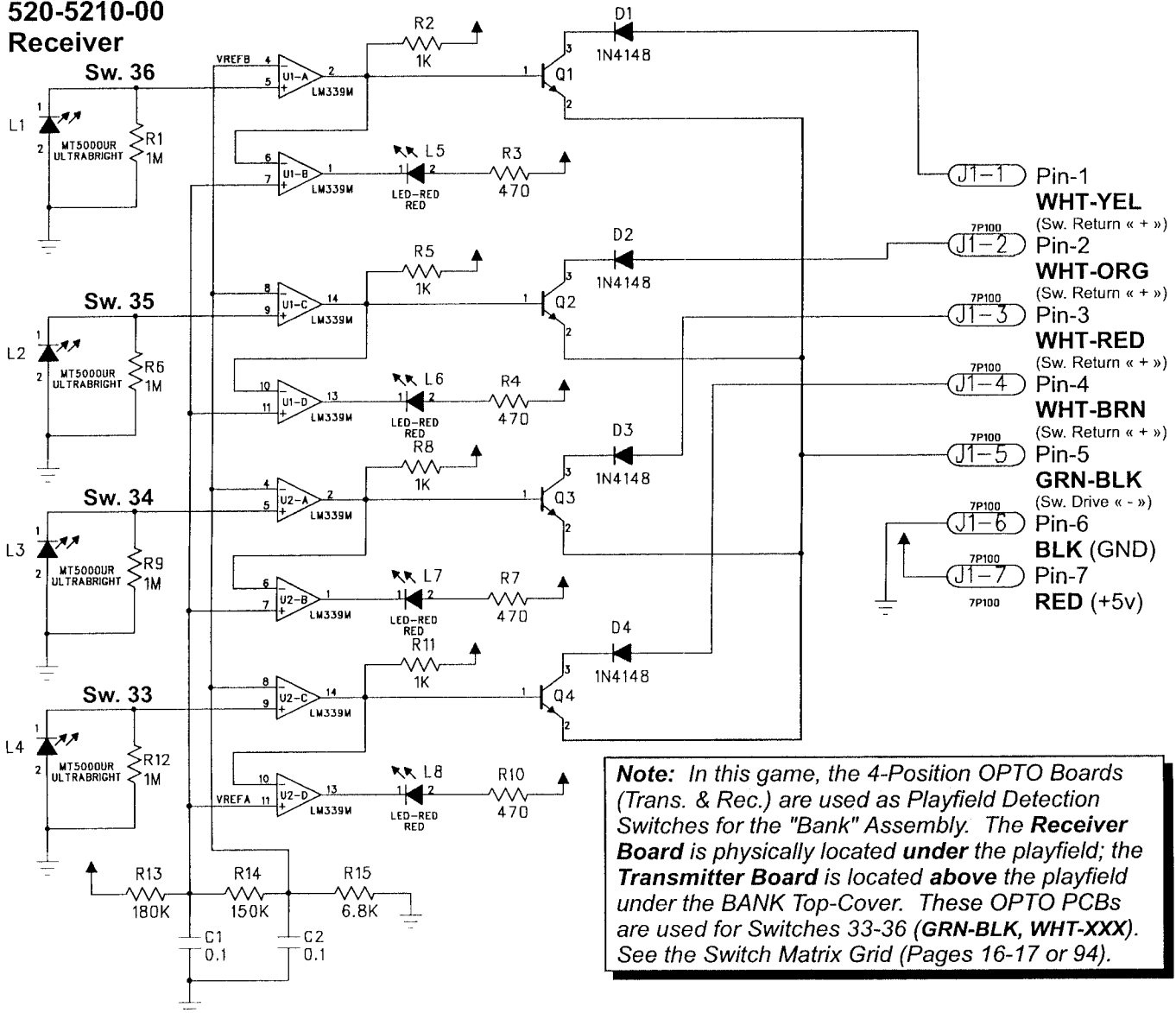

Note: In this game, the 4-Position OPTO Boards (Trans. & Rec.) are used as Playfield Detection Switches for the "Bank" Assembly. The Receiver Board is physically located under the playfield; the Transmitter Board is located above the playfield under the BANK Top-Cover. These OPTO PCBs are used for Switches 33-36 (GRN-BLK, WHT-XXX). See the Switch Matrix Grid (Pages 16-17 or 94).

Sec. 5: PCBs



4-Position OPTO (Trans. & Rec.) PC Boards Component Layout & Parts

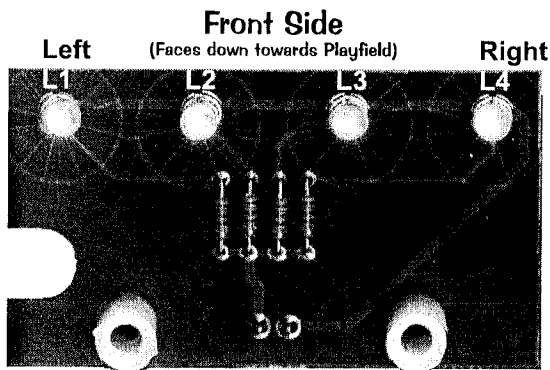

- L1 = Sw. 33
- L2 = Sw. 34
- L3 = Sw. 35
- L4 = Sw. 36

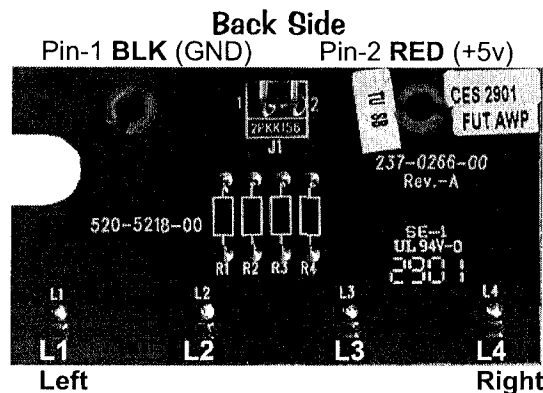

Transmitter ↑ (520-5218-00) Located above the Playfield, under the Bank Cover.

Receiver ↓ (520-5210-00) Located under the Playfield

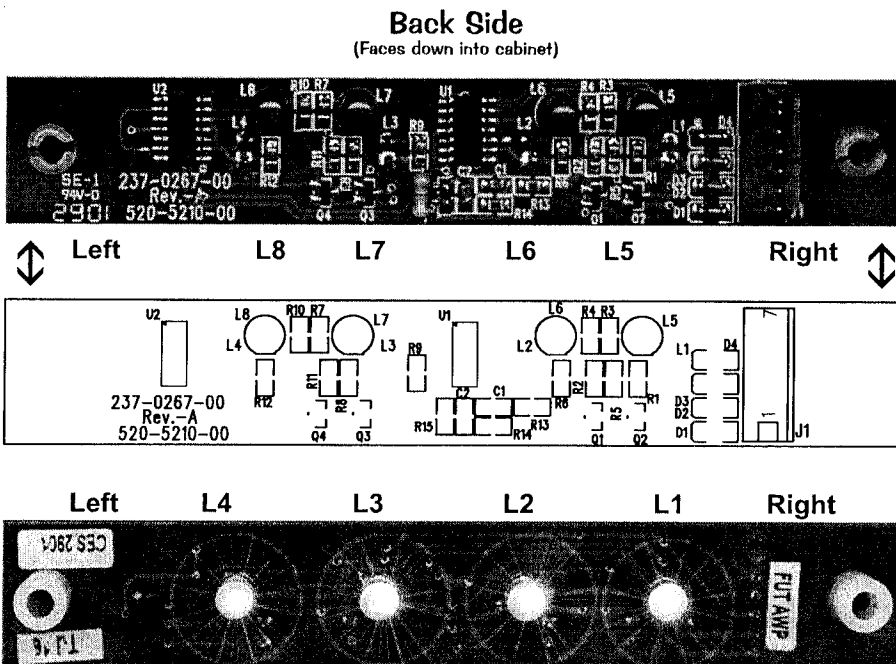

- Pin-1
WHT-YEL
(Sw. Return « + »)
 - Pin-2
WHT-ORG
(Sw. Return « + »)
 - Pin-3
WHT-RED
(Sw. Return « + »)
 - Pin-4
WHT-BRN
(Sw. Return « + »)
 - Pin-5
GRN-BLK
(Sw. Drive « - »)
 - Pin-6
BLK (GND)
 - Pin-7
RED (+5v)
- L4, L8 = Sw. 33
 - L3, L7 = Sw. 34
 - L2, L6 = Sw. 35
 - L1, L5 = Sw. 36

Front Side
(Faces up through playfield)

Note: In this game, the 4-Position OPTO Boards (Transmitter & Receiver) are used as Playfield Detection Switches for the "Bank" Assembly. The Receiver Board is physically located under the playfield; the Transmitter Board is located above the playfield under the BANK Top-Cover. These OPTO PCBs are used for Switches 33-36 (GRN-BLK, WHT-XXX). See the Switch Matrix Grid (Pages 16-17 or 94).

ITEM	QTY	PART NUMBER	REF-DESIGNATOR	DESCRIPTION
--	1	520-5218-00	4-Position OPTO (Transmitter) PC Board	PCB Assy. with Cable & Connector
1	2	254-5032-01	n/a	1/2" Slft. Rtn. #8 Spacer White
2	4	165-5052-00	L1, L2, L3, L4	LED TLRH180P (Ultra Bright Red)
3	4		R1, R2, R3, R4	180Ω 1/4 Res.
--	1	520-5210-00	4-Position OPTO (Receiver) PC Board	PCB Assy.
1	2	254-5007-01	n/a	3/8" Slft. Rtn. Spacer White
2	4	165-5052-00	L1, L2, L3, L4	LED TLRH180P (Ultra Bright Red)
3	4	165-5099-00	L5, L6, L7, L8	LED T1-3/4 DIFFUSER LED
4	2		U1, U2	LM339M, Semi-Conductor
5	4		D1, D2, D3, D4	1N4148, Diode
6	4		Q1, Q2, Q3, Q4	Transistor SMT
7	2		C1, C2	0.1, Capacitor SMT
8	4		R1, R6, R9, R12	1MΩ Resistor SMT
9	4		R2, R5, R8, R11	1KΩ Resistor SMT
10	4		R3, R4, R7, R10	470KΩ Resistor SMT
11	1		R13	180KΩ Resistor SMT
12	1		R14	150KΩ Resistor SMT
13	1		R15	6.8KΩ Resistor SMT



Dot Display (5X7) x3 PC Board (Electric Company Sign) Schematic

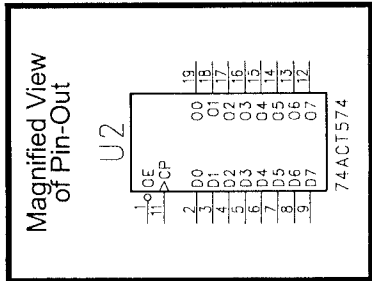
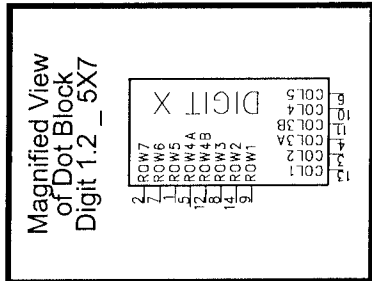
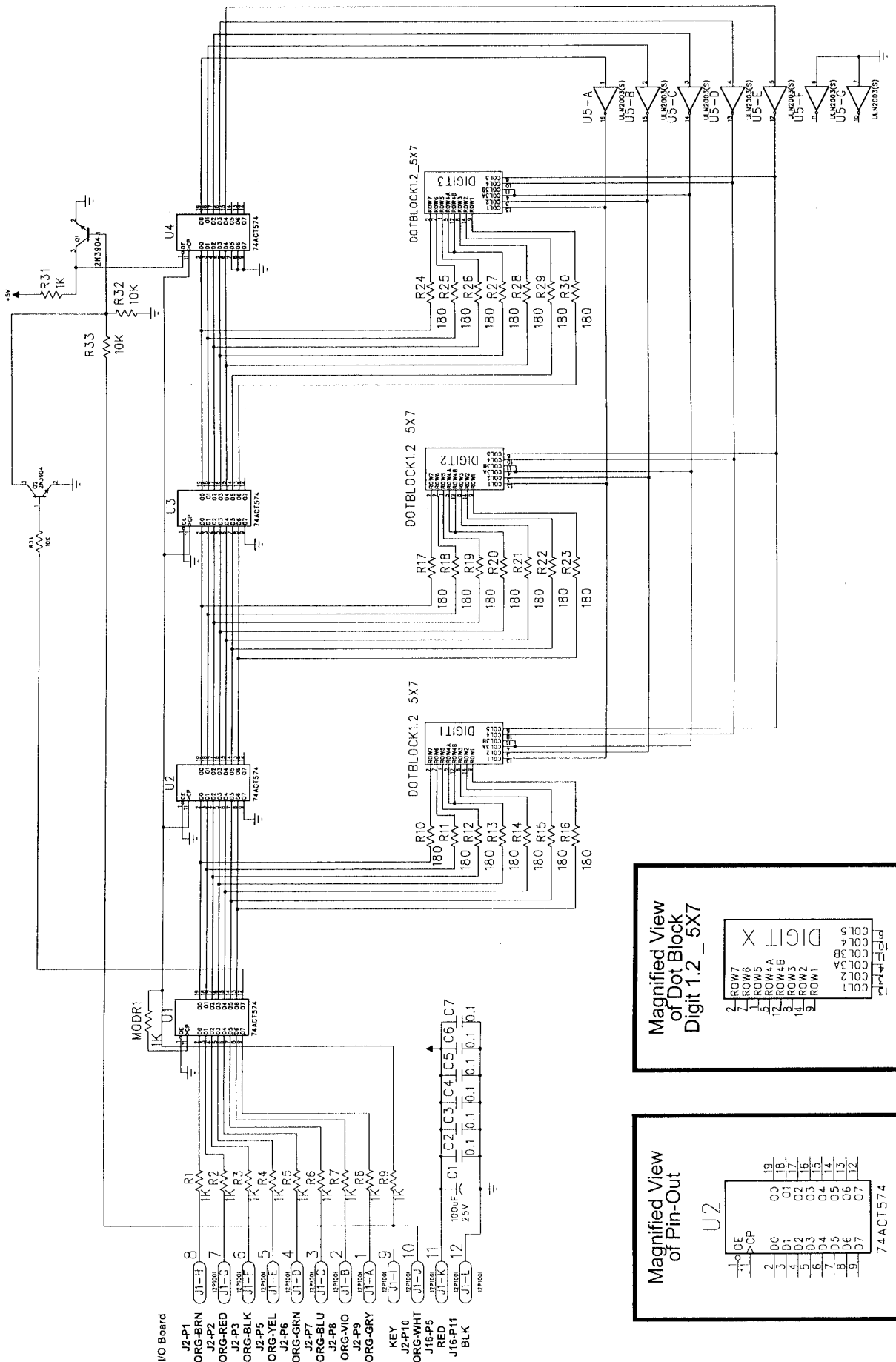

Dot Display (5X7) x3 PC Bd. (Electric Company Sign) Component Layout & Parts

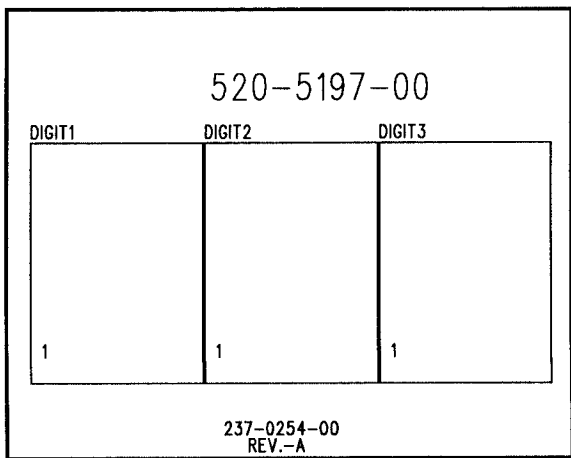

Component Side

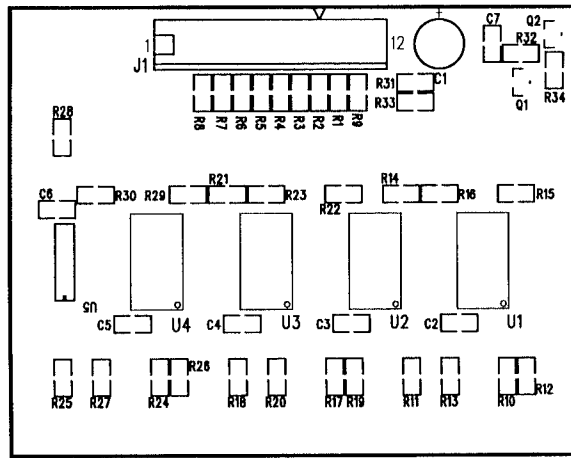

Solder Side

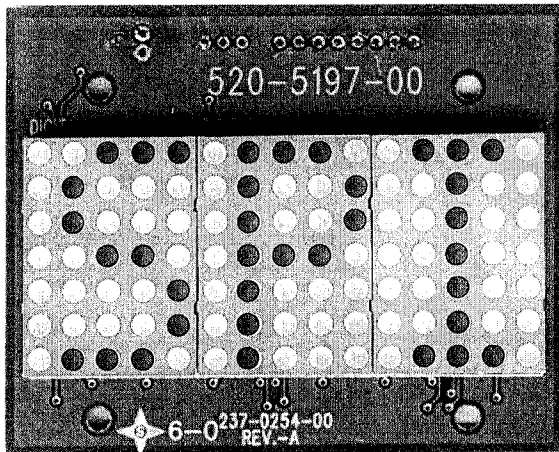

Component Side

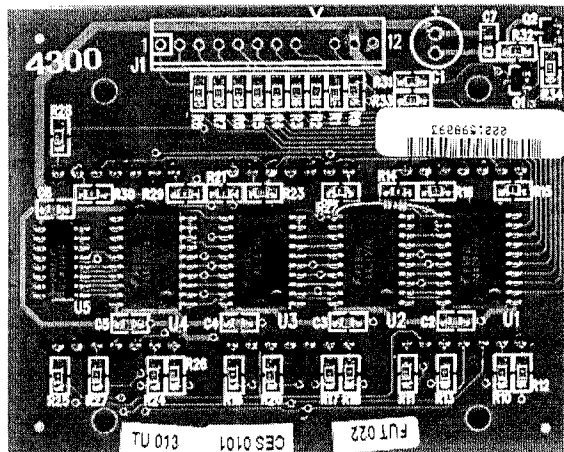

Solder Side

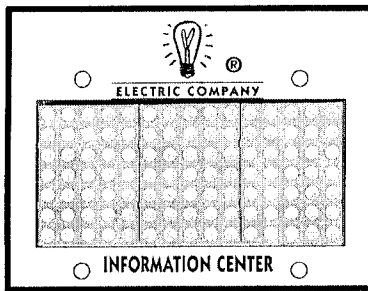

ITEM	QTY	PART NUMBER	REF-DESIGNATOR	DESCRIPTION
A	1	520-5197-00	Dot Display (5X7) x3 PC Board	PCB Assembly
1	1	100-5035-00	J1	9T Conn. 12P.1VM
2	2	112-5017-00	Q1, Q2	2N3904S 40V 0.2A
3	4	100-5036-00	U1, U2, U3, U4	74ACT574
4	6	100-5039-00	C2-C7	Cap. 104-0805 0.1 50V
5	3	100-5040-00	DIGIT1, DIGIT2, DIGIT3	Dot Block 1.2: 5X7 GMA8875C
6	3	121-5084-00	R32-R34	10KΩ 1/10W 0805 Res.
7	10	121-5088-00	R1-R9, R31	1KΩ 1/10W 0805 Res.
8	21	121-5086-00	R10-R30	180Ω 1/10W 0805 Res.
9	1	100-5037-00	C1	(Manex N°: 131-0003773)
10	1	100-5038-00	U5	(Manex N°: 225-0005340)
11	1	121-5089-00	MOD1	(Manex N°: 105-0002703)



(UK Only) Solenoid Expander PC Board Schematic

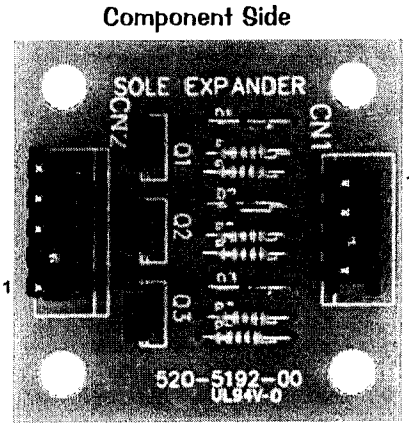
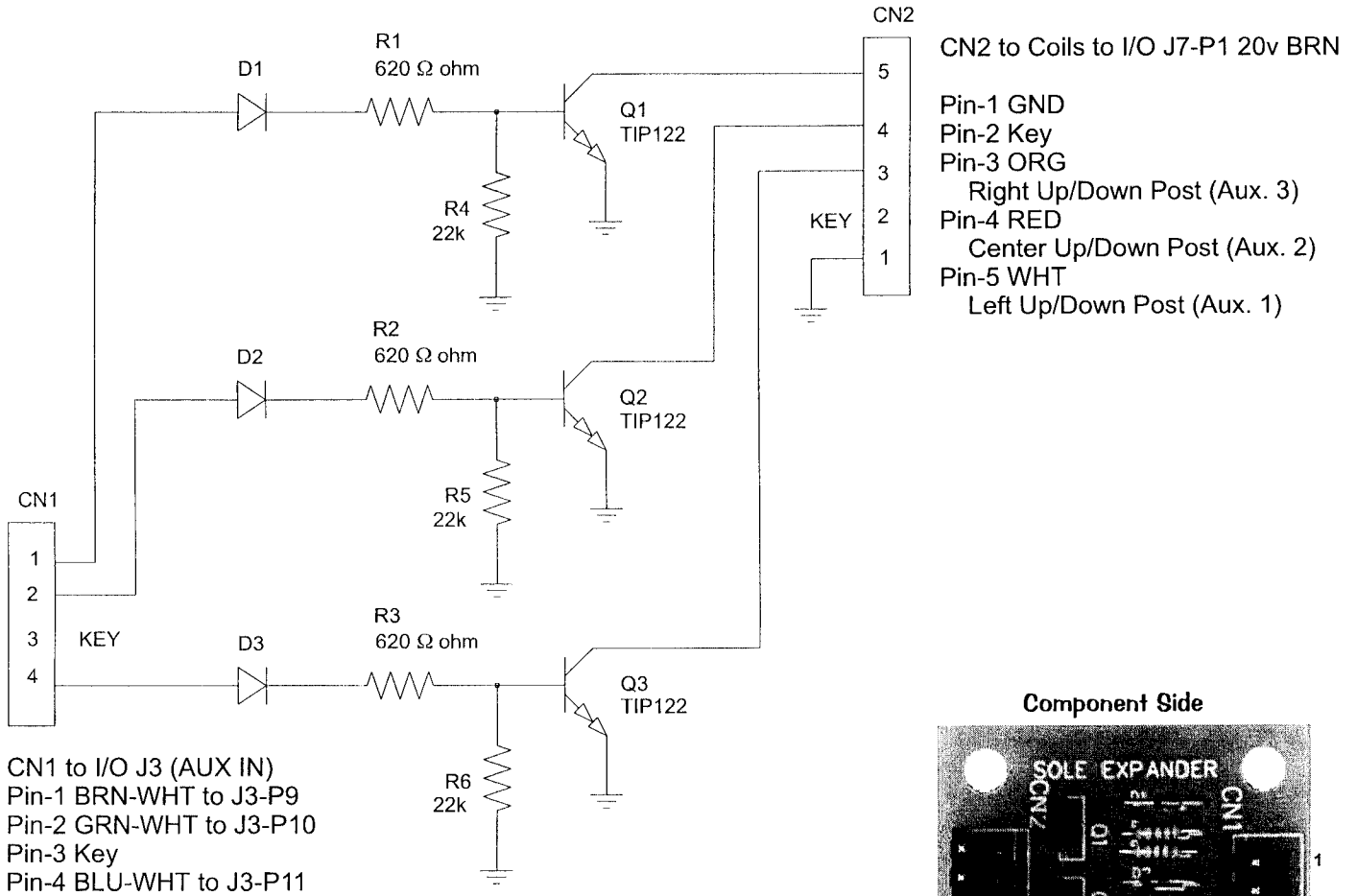

(UK Only) Solenoid Exp. PCB Component Layout & Parts

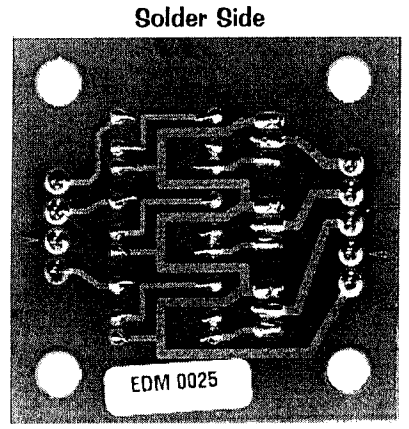
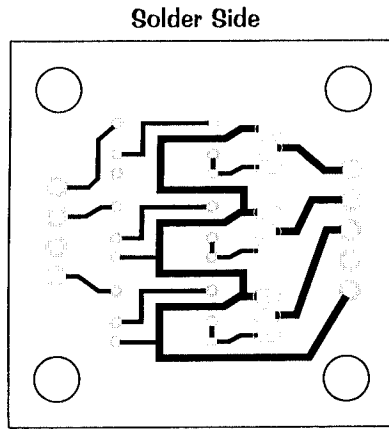
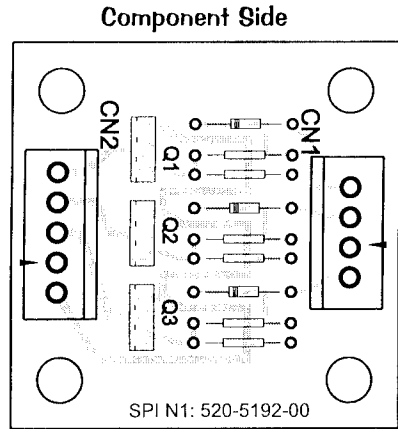

Sec. 5: PCBs

ITEM	QTY	PART NUMBER	REF-DESIGNATOR
1	1	520-5192-00	Solenoid Expander PC Board
2	1		CN1
3	1		CN2
4	3	112-5014-00	D1, D2, D3
5	3	121-5003-00	R1, R2, R3
6	3	121-5042-00	R4, R5, R6
	3	110-0067-00	Q1, Q2, Q3

DESCRIPTION

Complete PCB Assembly
 Connector, 4X .156"
 Connector, 5X .156"
 1N914, Signal Diode
 620Ω 1/4W CF Resistor
 22KΩ 1/4W CF Resistor
 Tip122 (NPN Darl. Transistor)



Appendixes A through I

Appendix Table of Contents

- **Appendix A, Pinball Game Firmware Table A2-A3**
...describes the EPROM with its chip size, the Stern™ Pinball, Inc. (SPI) Part N^o, version (if applicable), and CPU Board & CPU/Sound Board Pin location(s).
- **Appendix B, Semi-Conductors / I.C.'s / Relays Cross-Reference Table A4**
...describes diodes and transistors with Source N^o, SPI Part N^o, NTE N^o, ECG N^o, Radio Shack N^o & RCA Part N^o (If applicable).
- **Appendix C, Game Mfg. Date, Manual Part N^o & CPU Jumper Table A5**
...provides the Game Manufactured Date & Manual Part N^o, the CPU version, the EPROM Position, Jumpers Installed and Jumpers Removed (games specified).
- **Appendix D, Board Type Table A6-A7**
...provides Board Part N^os for Games Laser War through Batman Forever (Flipper, Sound, Power Supply, Dot Matrix Display, Display Controller & OPTOs) and the White Star Board System, Games Apollo 13 through current (Flipper*, I/O Power Driver, CPU/Sound, Display Power Supply, Dot Matrix Display, Display Controller & OPTOs; *Flipper Board with the White Star Bd. System for A13 & Golden Eye only.)
- **Appendix E, Generic Coil Cross-Reference Guide & Flipper Coil Table A8-A9**
...provides the Coils used with Part N^o and Gauge-Turns (of the coil).
- **Appendix F, Motor Specification Table A10-A11**
...provides all the Motor Function, Specifications and Part N^o for Games Laser War through current.
- **Appendix G, Part Number Prefix Classification Codes A12**
...explains how our Part Numbers are developed to help sort parts easier.
- **Appendix H, Playfield Inserts (Plastic Light Covers) A13**
...gives a pictorial view with the name and Part N^o of all the inserts used (also gives the Color Code Chart).
- **Appendix I, Stand-Up Targets (Happ Modular & Regular) A14**
...gives a pictorial view with the name and Part N^o of all the Single Stand-Up Targets used (also gives the Color Code Chart).
- **Glossary of Terms A15**
...gives definitions or explanations of some pinball terms and acronyms.
- **Parts Order Checklist Notes A16**
...keep track of your parts ordered through your distributor for this game.





APPENDIX A



Pinball Game Firmware (for White Star Board System) Table

ROM	Chip Size	Program Part N°	USA Ver. & Check Sum	Bd. Loc.	Raw Part N°
Apollo 13 (Note 1)					
Game ROM	(1M)	965-0208-00	A5.01 \$09FF	U210	960-5009-00
Sound	(512K)	965-0212-00		U7	960-7001-02
Display	(4M)	965-0213-00	A5.00 \$B92B	ROM 0	960-5015-01
Voice 1	(4M)	965-0209-00		U17	n/a (masked)
Voice 2	(4M)	965-0210-00		U21	n/a (masked)
Voice 3	(4M)	965-0211-00		U36	n/a (masked)
Golden Eye (Note 1)					
Game ROM	(1M)	965-0214-42	A4.04 \$3FFF	U210	960-5009-00
Sound	(512K)	965-0217-42		U7	960-7001-02
Display	(4M)	965-0218-42	A4.00 \$E6ED	ROM 0	960-5015-01
Voice 1	(4M)	965-0215-42		U17	n/a (masked)
Voice 2	(4M)	965-0216-42		U21	n/a (masked)
Twister (Note 2)					
Game ROM	(1M)	965-0219-41	A4.05 \$E9FF	U210	960-5009-00
Sound	(512K)	965-0221-41		U7	960-7001-02
Display	(4M)	965-0222-41	A4.01 \$FD01	ROM 0	960-5015-01
Voice 1	(4M)	965-0220-41		U17	960-5015-01
Voice 2	(4M)	965-0223-41		U21	960-5015-01
ID4: Independence Day (Note 2)					
Game ROM	(1M)	965-0224-45	A2.02 \$9CFF	U210	960-5009-00
Sound	(512K)	965-0227-45		U7	960-7001-02
Display	(4M)	965-0228-45	A2.00 \$ABF7	ROM 0	960-5015-01
Voice 1	(4M)	965-0225-45		U17	960-5015-01
Voice 2	(4M)	965-0226-45		U21	960-5015-01
Space Jam (Note 2)					
Game ROM	(1M)	965-0229-43	A3.00 \$E6FF	U210	960-5009-00
Sound	(512K)	965-0233-43		U7	960-7001-02
Display	(4M)	965-0234-43	A3.00 \$0057	ROM 0	960-5015-01
Voice 1	(4M)	965-0230-43		U17	960-5015-01
Voice 2	(4M)	965-0231-43		U21	960-5015-01
Voice 3	(4M)	965-0232-43		U36	960-5015-01
The Star Wars Trilogy - Special Edition (S.E.) (Note 2)					
Game ROM	(1M)	965-0235-56	A4.03 \$5EFF	U210	960-5009-00
Sound	(512K)	965-0238-56		U7	960-7001-02
Display	(4M)	965-0239-56	A4.00 \$8817	ROM 0	960-5015-01
Voice 1	(4M)	965-0236-56		U17	960-5015-01
Voice 2	(4M)	965-0237-56		U21	960-5015-01
The Lost World: Jurassic Park (Note 2)					
Game ROM	(1M)	965-0240-53	A2.01 \$C2FF	U210	960-5009-00
Sound	(512K)	965-0243-53		U7	960-7001-02
Display	(4M)	965-0244-53	A2.01 \$7F46	ROM 0	960-5015-01
Voice 1	(4M)	965-0241-53		U17	960-5015-01
Voice 2	(4M)	965-0242-53		U21	960-5015-01
The X-Files (Note 2)					
Game ROM	(1M)	965-0245-46	A3.03 \$A2FF	U210	960-5009-00
Sound	(512K)	965-0248-46		U7	960-7001-02
Display	(4M)	965-0249-46	A3.00 \$66D0	ROM 0	960-5015-01
Voice 1	(4M)	965-0246-46		U17	960-5015-01
Voice 2	(4M)	965-0247-46		U21	960-5015-01
Starship Troopers (Note 3)					
Game ROM	(1M)	965-0250-59	A2.00 \$85FF	U210	960-5009-00
Sound	(512K)	965-0253-59		U7	960-7001-02
Display	(4M)	965-0254-59	A2.00 \$E77B	ROM 0	960-5015-01
Voice 1	(4M)	965-0251-59		U17	960-5015-01
Voice 2	(4M)	965-0252-59		U21	960-5015-01
Voice 3	(4M)	965-0255-59		U36	960-5015-01
Viper Night Drivin' (Note 4)					
Game ROM	(1M)	965-0266-35	A2.01 \$C5FF	U210	960-5009-00
Sound	(512K)	965-0271-35		U7	960-7001-02
Display	(4M)	965-0272-35	A2.01 \$C17D	ROM 0	960-5015-01
Voice 1	(4M)	965-0267-35		U17	960-5015-01
Voice 2	(4M)	965-0268-35		U21	960-5015-01
Voice 3	(4M)	965-0269-35		U36	960-5015-01
Voice 4	(4M)	965-0270-35		U37	960-5015-01
Lost In Space (Note 4)					
Game ROM	(1M)	965-0282-60	A1.01 \$B2FF	U210	960-5009-00
Sound	(512K)	965-0287-60		U7	960-7001-02
Display	(4M)	965-0288-60	A1.02 \$32AB	ROM 0	960-5015-01
Voice 1	(4M)	965-0283-60		U17	960-5015-01
Voice 2	(4M)	965-0284-60		U21	960-5015-01
Voice 3	(4M)	965-0285-60		U36	960-5015-01
Voice 4	(4M)	965-0286-60		U37	960-5015-01
Godzilla (Note 4)					
Game ROM	(1M)	965-0289-40	A2.05 \$B1FF	U210	960-5009-00
Sound	(512K)	965-0294-40		U7	960-7001-02
Display	(4M)	965-0295-40	A2.00 \$C929	ROM 0	960-5015-01
Voice 1	(4M)	965-0290-40		U17	960-5015-01
Voice 2	(4M)	965-0291-40		U21	960-5015-01
Voice 3	(4M)	965-0292-40		U36	960-5015-01
Voice 4	(4M)	965-0293-40		U37	960-5015-01
South Park (Notes 4, 5)					
Game ROM	(1M)	965-0301-71	A1.03 \$58FF	U210	960-5009-00
Sound	(512K)	965-0306-71		U7	960-7001-02
Display	(4M)	965-0307-71	A1.01 \$166F	ROM 0	960-5015-01
Voice 1	(8M)	965-0302-71		U17	960-5016-00
Voice 2	(8M)	965-0303-71		U21	960-5016-00
Voice 3	(8M)	965-0304-71		U36	960-5016-00
Voice 4	(8M)	965-0305-71		U37	960-5016-00
Harley-Davidson® (Notes 4, 5)					
Game ROM	(1M)	965-0319-67	A1.03 \$3EFF	U210	960-5009-00
Sound	(512K)	965-0320-67		U7	960-7001-02
Display	(4M)	965-0321-67	A1.04 \$FC7C	ROM 0	960-5015-01
Voice 1	(8M)	965-0322-67		U17	960-5016-00
Voice 2	(8M)	965-0323-67		U21	960-5016-00
Voice 3	(8M)	965-0324-67		U36	960-5016-00
Voice 4	(4M)	965-0325-67		U37	960-5015-01

ROM	Chip Size	Program Part N°	USA Ver. & Check Sum	Bd. Loc.	Raw Part N°
Striker Xtreme (Notes 4, 5)					
Game ROM	(1M)	965-0326-68	A1.02 \$E4FF	U210	960-5009-00
Sound	(512K)	965-0327-68		U7	960-7001-02
Display	(4M)	965-0328-68	A1.03 \$1957	ROM 0	960-5015-01
Voice 1	(8M)	965-0329-68		U17	960-5016-00
Voice 2	(8M)	965-0330-68		U21	960-5016-00
Voice 3	(8M)	965-0331-68		U36	960-5016-00
Voice 4	(8M)	965-0332-68		U37	960-5016-00
NFL (Notes 4, 5)					
Game ROM	(1M)	965-0339-73	A1.00 \$D2FF	U210	960-5009-00
Sound	(512K)	965-0340-73		U7	960-7001-02
Display	(4M)	965-0341-73	A1.01 \$845A	ROM 0	960-5015-01
Voice 1	(8M)	965-0342-73		U17	960-5016-00
Voice 2	(8M)	965-0343-73		U21	960-5016-00
Voice 3	(8M)	965-0344-73		U36	960-5016-00
Voice 4	(8M)	965-0345-73		U37	960-5016-00
Sharkey's Shootout (Notes 4, 5)					
Game ROM	(1M)	965-0333-72	A2.04 \$5CFF	U210	960-5009-00
Sound	(512K)	965-0334-72		U7	960-7001-02
Display	(4M)	965-0335-72	A2.01 \$6C33	ROM 0	960-5015-01
Voice 1	(8M)	965-0336-72		U17	960-5016-00
Voice 2	(8M)	965-0337-72		U21	960-5016-00
Voice 3	(8M)	965-0338-72		U36	960-5016-00
High Roller Casino (Notes 4, 5)					
Game ROM	(1M)	965-0346-65	A2.10 \$19FF	U210	960-5009-00
Sound	(512K)	965-0347-65		U7	960-7001-02
Display	(4M)	965-0348-65	A2.00 \$13EE	ROM 0	960-5015-01
Voice 1	(8M)	965-0349-65		U17	960-5016-00
Voice 2	(8M)	965-0350-65		U21	960-5016-00
Voice 3	(8M)	965-0351-65		U36	960-5016-00
Voice 4	(8M)	965-0352-65		U37	960-5016-00
Austin Powers™ (Notes 4, 5)					
Game ROM	(1M)	965-0353-74	A3.00 \$ACFF	U210	960-5009-00
Sound	(512K)	965-0354-74		U7	960-7001-02
Display	(4M)	965-0355-74	A3.00 \$6A34	ROM 0	960-5015-01
Voice 1	(8M)	965-0356-74		U17	960-5016-00
Voice 2	(8M)	965-0357-74		U21	960-5016-00
Voice 3	(8M)	965-0358-74		U36	960-5016-00
Voice 4	(8M)	965-0359-74		U37	960-5016-00
Monopoly® (Notes 4, 5)					
Game ROM	(1M)	965-0360-75	A \$	U210	960-5009-00
Sound	(512K)	965-0361-75		U7	960-7001-02
Display	(4M)	965-0362-75	A \$	ROM 0	960-5015-01
Voice 1	(8M)	965-0363-75		U17	960-5016-00
Voice 2	(8M)	965-0364-75		U21	960-5016-00
Voice 3	(8M)	965-0365-75		U36	960-5016-00
Voice 4	(8M)	965-0366-75		PRODUCTION U37	960-5016-00

Footnotes:

- 1 ROMs on CPU/Sound Bd.: 520-5136-00 (Stereo) & Display Cont. Bd.: 520-5055-01
- 2 ROMs on CPU/Sound Bd.: 520-5136-10 (Mono) & Display Cont. Bd.: 520-5055-01
- 3 ROMs on CPU/Sound Board: 520-5136-15* (Mono) (*FCC 11-97) & Display Controller Board: 520-5055-02* (*FCC 11-97)
- 4 ROMs on CPU/Sound Bd.: 520-5136-16† (Mono) (†FCC 02-98) & Display Controller Board: 520-5055-03† (†FCC 02-98)
- 5 This game uses 8MB VOICE ROMS at U17, U21, U36 & U37 (if 3 ROMs use U37 will be unused) requiring a Jumper at Loc. W6. Refer to CPU/Snd. Bd. Schematic (2 of 3).

Game Revisions can be updated after the Production Run. This Table is accurate as of the printing of this manual. If any changes occurred, the next game manual will include the updated information. The version stated is USA. If there is a question as to the latest Code Revision & Check Sum call our Technical Support Department, 1-800-542-5377 or 1-708-345-7700 (Select Option 1). Visit our website www.SternPinball.com where code can be downloaded (an EPROM Burner is required).



APPENDIX B

Semi-Conductors / Integrated Circuits (I.C.) / Relays Cross-Reference Table

Table No	Type	Source Number	STERN™ PINBALL	N T E®	E C G®	Radio Shack®	R C A®
RECTIFICATION, BLOCKING, DAMPENING DIODES AND/OR LIGHT EMITTING DIODES (LEDs)							
1	Diode	1N4001	112-5001-00	NTE552	ECG552	-----	SK9000
	Diode	1N4004	112-5003-00	NTE116	ECG116	276-1103	SK3312
	Diode	1N5401	112-0056-00	NTE5801	ECG5801	276-1143	SK9004
	Diode	1N5404	112-5004-00	NTE5804	ECG5804	276-1144	SK9007
	Diode	T6A10L	112-5006-01	NTE5812	ECG5812	-----	-----
	Diode	FR302	112-5009-00	NTE588	ECG588	-----	SK5014
	Diode, Signal	1N914	112-5014-00	-----	-----	-----	-----
	LED	MT5000UR or TLRH180P (T1-3/4 GaAlAs)	165-5052-00 <i>(old SPI Part No: 165-5100-00)</i>	-----	-----	276-066B	-----
ZENER DIODES							
2	Diode	1N4742A 12v	112-0061-00	NTE142A	ECG142A	276-563	SK12V
	Diode	1N4760B 68v	112-0062-00B	NTE5092A	ECG5092A	-----	SK68V
	Diode	1N4764A 100v	112-0049-00A	NTE5096A	ECG5096A	-----	SK100V
	Diode	1N5228 3.9v	112-0053-00	NTE5007A	ECG5007A	-----	SK3A9
	Diode	1N5234B 6.2v	112-0047-00B	NTE5013A	ECG5013A	276-561	SK6A2
	Diode	1N5379 110v	112-0072-00	NTE5157	ECG5157	-----	SK110X
	Diode	1N6267A 6.8v	112-5011-00	NTE4902	ECG4902	-----	-----
	Diode	1N4752A 33v	112-5010-00A	NTE147A	ECG147A	-----	SK33V
	Diode	1N4736 6.8v 1w	112-5007-00	NTE5071A	ECG5071A	-----	-----
TRANSISTORS - TYPE FET, NPN, PNP AND/OR SCR							
3	FET Trans.	STP20N10L	110-0106-00	NTE2987	ECG2987	-----	-----
	FET Trans.	STP19N06L	110-0088-00	NTE2985	ECG2985	-----	-----
	FET Trans.	VN02N	110-0089-00	-----	-----	-----	-----
	NPN Trans.	2N4401	110-0073-00	NTE85	ECG85	276-2009	SK3124A
	NPN Trans.	2N6427	110-0070-00	NTE48	ECG48	-----	SK4906
	NPN Trans.	MJE340	110-0071-00	NTE157	ECG157	-----	SK3747
	NPN Trans.	MPSA42	110-0082-00	NTE287	ECG287	-----	SK3232
	NPN Trans.	2N3904	110-0069-00	NTE123AP	ECG123AP	276-2009	-----
	NPN Trans.	TIP122	110-0067-00	NTE261	ECG261	276-2068	SK3896
	NPN Trans.	MJE15030	110-0101-00	NTE375	ECG375	-----	SK9118
	PNP Trans.	2N5401	110-0078-00	NTE288	ECG288	-----	SK3434
	PNP Trans.	MJE15031	110-0103-00	NTE292	ECG292	-----	SK3441
	PNP Trans.	MJE350	110-0072-00	NTE374	ECG374	-----	SK9042
	PNP Trans.	MPSA92	110-0100-00	NTE288	ECG278	-----	SK3434
	PNP Trans.	TIP42	110-0068-00	NTE332	ECG332	-----	SK9236
	PNP Trans.	TIP32C	110-0081-00	NTE292	ECG292	-----	SK3441
	PNP Trans.	TIP36C	110-0077-00	NTE393	ECG393	-----	SK3961
	SCR Trans.	2N5060	110-0074-00	NTE5400	ECG5400	276-1067	SK3950
SCR Trans.	SCR2800B	110-0083-00	NTE5461-8	ECG5461-8	-----	-----	
BRIDGE RECTIFIERS (BR)				Comments:			
4	BR (Present)	DB3501 or CM3501	112-5000-00	For White Star I/O Bds., BR = 35 Amp @ 100v P.I.V.			
RELAYS				Comments:			
5	Relay	FRL-264 D024/02CK	190-5002-00	For PPB, Power Supply, & White Star I/O Boards, Relay = 24v DC 10 Amp DPDT			
	Relay	FRL-264 D006/04CV	190-5001-00	For CPU Boards, Relay = 6v DC 5 Amp 4 Pole DT			



APPENDIX C

Game Mfg. Date, Manual Part N^o & CPU Jumper Table†

Game Name	Game Mfg. Date and Manual PN ^o	CPU Ver.	EPROM Position	Jumpers Installed (see Note)	Jumpers Removed (see Note)
1. Laser War	MAY 87 780-5001-00	1	5C	J4 J6a J7a	J5 J6 J7b
2. Secret Service	MAR 88 780-5002-00	2	5B, 5C	J4	J5
3. Torpedo Alley	AUG 88 780-5003-00	2	5B, 5C	J4	J5
4. Time Machine	DEC 88 780-5004-00	2	5B, 5C	J4	J5
5. Playboy 35th Anniversary	MAY 89 780-5005-00	2	5B, 5C	J4	J5
6. ABC Monday Night Football	SEP 89 780-5007-00	2	5B, 5C	J4	J5
7. Robocop	NOV 89 780-5006-00	2	5B, 5C	J4	J5
8. Phantom of the Opera	JAN 90 780-5008-00	2	5B, 5C	J4	J5
9. Back to the Future	JUN 90 780-5009-00	3	5B, 5C	J4	J5
10. The Simpsons	SEP 90 780-5012-00	3	5B, 5C	J4	J5
11. Checkpoint	FEB 91 780-5010-00	3	5B, 5C	J4	J5
12. Teenage Mutant Ninja Turtles	MAY 91 780-5017-00	3	5B, 5C	J4	J5
13. Batman	JUL 91 780-5011-00	3	5B, 5C	J4	J5
14. Star Trek 25th Anniversary	OCT 91 780-5014-00	3	5C	J5	J4
15. Hook	JAN 92 780-5019-00	3	5C	J5	J4
16. Lethal Weapon 3	JUN 92 780-5026-00	3	5C	J5	J4
17. Star Wars	OCT 92 780-5024-00	3	5C	J5	J4
18. Rocky & Bullwinkle & Friends	FEB 93 780-5022-00	3	5C	J5	J4
19. Jurassic Park	APR 93 780-5020-00	3	5C	J5	J4
20. Last Action Hero	AUG 93 780-5027-00	3	5C	J5	J4
21. Tales from the Crypt	NOV 93 780-5018-00	3	5C	J5	J4
22. The Who's Tommy	FEB 94 780-5028-00	3	5C	J5	J4
23. WWF Royal Rumble	MAY 94 780-5023-00	3	5C	J5	J4
24. Guns-N'-Roses	JUL 94 780-5029-00	3	5C	J5	J4
25. Maverick	SEP 94 780-5031-00	3	5C	J5	J4
26. Mary Shelley's Frankenstein	DEC 94 780-5036-00	3	5C	J5	J4
27. Baywatch	MAR 95 780-5033-00	3	5C	J5	J4
28. Batman Forever	JUL 95 780-5038-00	3	5C	J5	J4

Game Name	Game Mfg. Date and Manual PN ^o	CPU Ver.	EPROM Position	Jumpers Installed	Jumpers Removed
29. Apollo 13 (A13)	NOV 95 780-5044-00	—	U210	n/a	n/a
30. Golden Eye	FEB 96 780-5042-00	—	U210	n/a	n/a
31. Twister	APR 96 780-5041-00	—	U210	n/a	n/a
32. ID4: Independence Day	JUL 96 780-5045-00	—	U210	n/a	n/a
33. Space Jam	OCT 96 780-5043-00	—	U210	n/a	n/a
34. The Star Wars Trilogy - S.E.	FEB 97 780-5056-00	—	U210	n/a	n/a
35. The Lost World: J.P.	JUN 97 780-5053-00	—	U210	n/a	n/a
36. The X-Files	AUG 97 780-5046-00	—	U210	n/a	n/a
37. Starship Troopers	NOV 97 780-5059-00	—	U210	n/a	n/a
38. Viper Night Drivin'	FEB 98 780-5035-00	—	U210	n/a	n/a
39. Lost In Space	JUN 98 780-5060-00	—	U210	n/a	n/a
40. Godzilla	SEP 98 780-5040-00	—	U210	n/a	n/a
41. South Park	JAN 99 780-5071-00	—	U17 U21 U36 U37	W6 CPU/Snd.	n/a
42. Harley-Davidson®	AUG 99 780-5067-01	—	U17 U21 U36 U37	W6 CPU/Snd.	n/a
43a. Striker Xtreme	MAR 00 780-5068-01	—	U17 U21 U36 U37	W6 CPU/Snd.	n/a
43b. NFL	OCT 00 780-5073-00	—	U17 U21 U36 U37	W6 CPU/Snd.	n/a
44. Sharkey's Shootout	OCT 00 780-5072-01	—	U17 U21 U36	W6 CPU/Snd.	n/a
43. High Roller Casino	JAN 01 780-5065-00	—	U17 U21 U36 U37	W6 CPU/Snd.	n/a
44. Austin Powers™	MAY 01 780-5074-00	—	U17 U21 U36 U37	W6 CPU/Snd.	n/a
45. MONOPOLY®	SEP 01 780-5075-00	—	U17 U21 U36 U37	W6 CPU/Snd.	n/a

† Additional Information for Installed / Removed Jumpers (List 1-28 only):

Board Combinations with ROM at Location 5C (Game 1, Ver1) Installed J1b, J3, J4, J6a, J7a & J8 Removed J1a, J2, J5, J6 & J7b

Board Combinations w/ ROM at Locations 5B, 5C (Game 1, Ver2) Installed J1b, J3, J4, J5a, J6a, J7b & J8 Removed J1a, J2, J5, J5b, J6b, & J7a

Board Combinations w/ ROM at Locations 5B, 5C (Games 2-12, Ver2/3) Installed J1b, J3, J4, J5b, J6b, J7b & J8 Removed J1a, J2, J5, J5a, J6a & J7a

Board Combinations with ROM at Locations 5C (Games 14-28, Ver3) Installed J1b, J3, J5, J5b, J6b, J7b & J8 Removed J1a, J2, J4, J5a, J6a & J7a

* Version 1 has a 2K RAM which is a 24-pin IC in Position 5D; Versions 2 & 3 have a 8K RAM which is a 28-PIN IC in Position 5D.

Appendix C:

Game Mfg. Date, Manual ... &



CPU Jumper Table

A5

APPENDIX D

Board Type Table

Game Name	Flipper	Sound	Power Supply	Display X-Digit
Laser War	2-Flipper Board Not Required	initial: 520-5002-00 replaced with: 520-5002-02 <small>520-5002-01 was not used.</small>	520-5000-00	Master: 520-5004-00 plus: 520-5005-00 (Qty. 2): 7 Digit Alpha/Numeric 520-5006-00 (Qty. 2): 7 Digit Numeric 520-5007-00 (Qty. 1): 4 Digit Numeric
Secret Service	3-Flipper Board Not Required	520-5002-02	520-5000-00	520-5014-01 7 Digit Alpha/Numeric Combined
Torpedo Alley	3-Flipper Board Not Required	520-5002-02	520-5000-00	520-5014-01 7 Digit Alpha/Numeric Combined
Time Machine	2-Flipper Board Not Required	520-5002-02	520-5000-00	520-5014-01 7 Digit Alpha/Numeric Combined
Playboy 35th Anniversary	520-5033-00 2-Flipper (for 100 games)	520-5002-02	520-5000-00	520-5014-01 7 Digit Alpha/Numeric Combined
ABC Monday Night Football	520-5033-00 2-Flipper (for 100 games)	520-5002-02	520-5000-00	520-5030-00 16 Digit Alpha/Numeric Combined
Robocop	520-5033-00 2-Flipper	520-5002-02	520-5000-00	520-5030-00 16 Digit Alpha/Numeric Combined
Phantom of the Opera	520-5033-00 2-Flipper	520-5002-02	520-5000-00	520-5030-00 16 Digit Alpha/Numeric Combined
Back to the Future	520-5033-00 2-Flipper	520-5002-02	520-5000-00	520-5030-00 16 Digit Alpha/Numeric Combined
The Simpsons	520-5033-00 2-Flipper	520-5002-03	520-5000-00	520-5030-00 16 Digit Alpha/Numeric Combined

Game Name	Flipper	Sound	Power Supply	Dot Matrix Display	Display Controller	OPTO Transmitter	OPTO Receiver	OPTO Application
Checkpoint	520-5033-00 2-Flipper	520-5002-03	520-5047-00	520-5042-00 128 X 16				
Teenage Mutant Ninja Turtles	520-5033-00 2-Flipper	520-5002-03	520-5047-00	520-5042-00 128 X 16				
Batman	520-5033-00 2-Flipper	520-5050-01	520-5047-00	520-5042-00 128 X 16				
Star Trek 25th Anniversary	520-5033-00 2-Flipper	520-5050-01	520-5047-00	520-5042-00 128 X 16				
Hook	520-5033-00 2-Flipper	520-5050-01	520-5047-00	520-5042-00 128 X 16				
Lethal Weapon 3	520-5033-00 2-Flipper	520-5050-01	520-5047-01	520-5052-00 128 X 32	520-5055-00			
Star Wars	520-5033-00 2-Flipper	520-5050-02	520-5047-01	520-5052-00 128 X 32	520-5055-00			
Rocky & Bullwinkle & Friends	520-5033-00 2-Flipper	520-5050-02	520-5047-01	520-5052-00 128 X 32	520-5055-00			
Jurassic Park	520-5076-00 3-Flipper	520-5050-02	520-5047-02	520-5052-00 128 X 32	520-5055-00			
Last Action Hero	520-5070-00 2-Flipper	520-5050-03	520-5047-02	520-5052-00 128 X 32	520-5055-00			
Tales from the Crypt	520-5076-00 3-Flipper	520-5050-03	520-5047-02	520-5052-00 128 X 32	520-5055-01			
The Who's Tommy	520-5076-00 3-Flipper	520-5077-00	520-5047-02	520-5052-00 128 X 32	520-5055-01			
WWF Royal Rumble	520-5070 / 5080 -00 4-Flipper (2X2)	520-5077-00	520-5047-02	520-5052-00 128 X 32	520-5055-01			
Guns N' Roses	520-5076-00 3-Flipper	520-5077-00	520-5047-02	520-5052-00 128 X 32	520-5055-01			
Maverick	520-5076-00 3-Flipper	520-5050-03	520-5047-03	520-5075-00 192 X 64	520-5092-01	520-5102-00 Single OPTO	520-5103-00 Single OPTO	Paddle Boat Wheel Enter
Mary Shelley's Frankenstein	520-5076-00 3-Flipper	520-5077-00	520-5047-03	520-5075-00 192 X 64	520-5092-01			
Baywatch	520-5070 / 5080 -00 4-Flipper (2X2)	520-5126-02	520-5047-03	520-5075-00 192 X 64	520-5092-01	520-5124-00 Single OPTO	520-5125-00 Single OPTO	5-Ball Trough over Up-Kicker
Batman Forever	520-5076-00 3-Flipper	520-5126-02	520-5047-03	520-5075-00 192 X 64	520-5092-01	520-5124-00 Single OPTO	520-5125-00 Single OPTO	4-Ball Trough over Up-Kicker

Miscellaneous Boards (Lamp Boards & Relay Boards) not listed above can be found in each individual game manual.

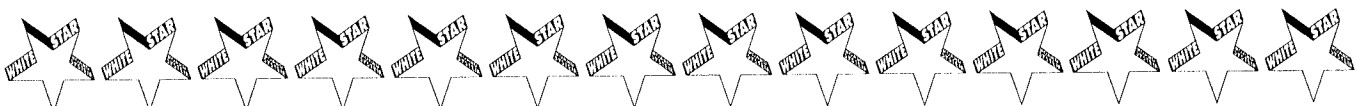

GAMES HEREON USE THE WHITE STAR BOARD SYSTEM™ (with the addition of the I/O Power Driver Board):

Game Name	Flipper	I/O Power Driver	CPU/Sound Stereo	Disp. Power Supply	Dot Matrix Display	Display Controller	OPTO Transmitter	OPTO Receiver	OPTO Application
Apollo 13	520-5080-00 2-Flipper	520-5137-00	520-5136-00	520-5138-00	520-5052-00 128 X 32	520-5055-01	520-5124-00 Single OPTO	520-5125-00 Single OPTO	5-Ball Trough over Up-Kicker
	Miscellaneous PC Boards:	Light Boards 520-5130-01, -04 & -05 Magnet Interface, 7-Segment Display & Light Bd. 520-5130-06 Magnet Driver Board 520-5130-02 Switch Membrane Board 520-5130-03			Relay Board 520-5010-00				
Golden Eye	520-5080-00 2-Flipper	520-5137-00	520-5136-00	520-5138-00	520-5052-00 128 X 32	520-5055-01	520-5124-00 Single OPTO	520-5125-00 Single OPTO	5-Ball Trough over Up-Kicker
	Miscellaneous PC Boards:	Light Boards 520-5128-05 through -08		Mag. Processor X2 Driver Bd. 520-5143-00	Relay Board 520-5010-00				

Table continued on the next page.



APPENDIX D

Board Type Table

GAMES HEREON USE THE WHITE STAR BOARD SYSTEM™ (with the deletion of the Flipper Board):

Game Name	I/O Power Driver	CPU/Sound Mono	Disp. Power Supply	Dot Matrix Display	Display Controller	OPTO Transmitter	OPTO Receiver	OPTO Application	Misc OPTO & App.
Twister	520-5137-01	520-5136-10	520-5138-00	520-5052-00 128 X 32	520-5055-01	520-5124-00 Single OPTO	520-5125-00 Single OPTO	5-Ball Trough over Up-Kicker	
	Miscellaneous PC Boards:	Light Boards 520-5145-01 through -07		Mag. Drv. Bd. 520-5143-00	Relay Board 520-5010-00				
Independence Day (ID4)	520-5137-01	520-5136-10	520-5138-00	520-5052-00 128 X 32	520-5055-01	520-5124-00 Single OPTO	520-5125-00 Single OPTO	4-Ball Trough over Up-Kicker	
	Miscellaneous PC Boards:	Light Boards 520-5149-01 through -10		Servo Mtr. Bd. 520-5152-00		520-5082-00 Long Hop opto	520-5083-00 Long Hop opto	Alien Head Enter	
Space Jam	520-5137-01	520-5136-10	520-5138-00	520-5052-00 128 X 32	520-5055-01	520-5124-00 Single OPTO	520-5125-00 Single OPTO	5-Ball Trough over Up-Kicker	
	Miscellaneous PC Boards:	2X 7-Segment Display Board 520-5153-00							
The Star Wars Trilogy - Special Ed.	520-5137-01	520-5136-10	520-5138-00	520-5052-00 128 X 32	520-5055-01	520-5124-00 Single OPTO	520-5125-00 Single OPTO	4-Ball Trough over Up-Kicker	
	Miscellaneous PC Boards:	Relay Board 520-5010-00							
The Lost World: J.P.	520-5137-01	520-5136-10	520-5138-00	520-5052-00 128 X 32	520-5055-01	520-5124-00 Single OPTO	520-5125-00 Single OPTO	4-Ball Trough over Up-Kicker	520-5162-00 2-Pos. Motor Sensor on Snagger Motor
	Miscellaneous PC Boards:	DC Relay Bd. 520-5066-00	Shaker Mtr. Bd. 520-5065-00						
The X-Files	520-5137-01	520-5136-10	520-5138-00	520-5052-00 128 X 32	520-5055-01	520-5124-00 Single OPTO	520-5125-00 Single OPTO	4-Ball Trough over Up-Kicker	520-5155-00 3-Pos. Motor Sensor on File Cab. Motor
	Miscellaneous PC Boards:					520-5082-00 Long Hop opto	520-5083-00 Long Hop opto	File Cabinet Enter	
Starship Troopers	520-5137-01	520-5136-15	520-5138-00	520-5052-00 128 X 32	520-5055-02	520-5124-00 Single OPTO	520-5125-00 Single OPTO	4-Ball Trough over Up-Kicker	
	Miscellaneous PC Boards:	4X 7-Segment Display Board 520-5166-00				520-5082-00 Long Hop opto	520-5083-01 Long Hop opto	L/R Orbit Lane Enter	
Viper Night Drivin'	520-5137-01	520-5136-16	520-5138-00	520-5052-00 128 X 32	520-5055-03	520-5124-00 Single OPTO	520-5125-00 Single OPTO	4-Ball Trough over Up-Kicker	
	Miscellaneous PC Boards:	Relay Board 520-5010-00				520-5082-00 Long Hop opto	520-5083-01 Long Hop opto	Jump Ramp	
Lost In Space	520-5137-01	520-5136-16	520-5138-00	520-5052-00 128 X 32	520-5055-03	520-5173-00 Dual OPTO	520-5174-00 Dual OPTO	4-Ball Trough over Up-Kicker	
	Miscellaneous PC Boards:	Relay Board 520-5010-00							
Godzilla	520-5137-01	520-5136-16	520-5138-00	520-5052-00 128 X 32	520-5055-03	520-5173-00 Dual OPTO	520-5174-00 Dual OPTO	4-Ball Trough over Up-Kicker	
	Miscellaneous PC Boards:	Shaker Mtr. Bd. 520-5065-00							
South Park	520-5137-01	520-5136-16	520-5138-00	520-5052-00 128 X 32	520-5055-03	520-5173-00 Dual OPTO	520-5174-00 Dual OPTO	5-Ball Trough over Up-Kicker	
	Miscellaneous PC Boards:					520-5082-00 Long Hop opto	520-5083-01 Long Hop opto	Kenny Under Trough Enter	
Harley-Davidson®	520-5137-01	520-5136-16	520-5138-00	520-5052-00 128 X 32	520-5055-03	520-5173-00 Dual OPTO	520-5174-00 Dual OPTO	4-Ball Trough over Up-Kicker	
	Miscellaneous PC Boards:	Relay Board 520-5010-00	Shaker Mtr. Bd. 520-5065-00	Diode Board 520-5146-00		520-5082-00 Long Hop opto	520-5083-01 Long Hop opto	Motorcycle Enter	
Striker Xtreme (NFL)	520-5137-01	520-5136-16	520-5138-00	520-5052-00 128 X 32	520-5055-03	520-5173-00 Dual OPTO	520-5174-00 Dual OPTO	4-Ball Trough over Up-Kicker	520-5155-00 3-Pos. Motor Sensor on Goalie Motor
	Miscellaneous PC Boards:	DC Relay Bd. 520-5066-00	Relay Board 520-5010-00	Diode Board 520-5146-00	for UK ONLY> Solenoid Expander Bd. 520-5192-00	520-5082-00 Long Hop opto	520-5083-01 Long Hop opto	Goalie Under- Trough Enter	
Sharkey's Shootout	520-5137-64	520-5136-64	520-5138-00	520-5052-00 128 X 32	520-5055-03	520-5173-00 Dual OPTO	520-5174-00 Dual OPTO	4-Ball Trough over Up-Kicker	520-5194-00 4-Pos. Motor Sensor on ? -Ball Motor
	Miscellaneous PC Boards:	Relay Board 520-5010-00	Sol. Exp. Bd. 520-5192-00						
High Roller Casino	520-5137-01	520-5136-16	520-5138-00	520-5052-00 128 X 32	520-5055-03	520-5173-00 Dual OPTO	520-5174-00 Dual OPTO	4-Ball Trough over Up-Kicker	520-5194-00 4-Pos. Motor Sensor on Roulette Wheel Motor
	Miscellaneous PC Boards:	Dot Display (5X7) in Slot Mach. 520-5197-00			for UK ONLY> Solenoid Expander Bd. 520-5192-00	520-5082-00 Long Hop opto	520-5083-01 Long Hop opto	Ball Lock Under Roulette	
Austin Powers™	520-5137-01	520-5136-16	520-5138-00	520-5052-00 128 X 32	520-5055-03	520-5173-00 Dual OPTO	520-5174-00 Dual OPTO	4-Ball Trough over Up-Kicker	520-5212-00 Pulse-Stretcher OPTO on Spini-Me
	Miscellaneous PC Boards:	Relay Bd. (X3) 520-5010-00			for UK ONLY> Solenoid Expander Bd. 520-5192-00				
Monopoly®	520-5137-01	520-5136-16	520-5138-00	520-5052-00 128 X 32	520-5055-03	520-5173-00 Dual OPTO	520-5174-00 Dual OPTO	4-Ball Trough over Up-Kicker	
	Miscellaneous PC Boards:	DC Relay Bd. 520-5066-00	Dot Display (5X7) in Elec. Sign 520-5197-00		for UK ONLY> Solenoid Expander Bd. 520-5192-00	520-5218-00 4-Pos. OPTO	520-5210-00 4-Pos. OPTO	Bank Door	

† **Note:** To order Game Specific CPU/Sound Board please specify Game Name.



APPENDIX E

Generic Coil Cross-Reference Guide † ‡

STANDARD COILS						FLIPPER COILS			
GA-TURNS	Res. (Ω)	SPI PART N°	GA-TURNS	Res. (Ω)	SPI PART N°	GAUGE-TURNS	Res. (Ω)	COLOR	SPI PART N°
20-400	1.0 Ω	090-5021-00	24-940 †	5.5 Ω	090-5036-00T	21-900 †	not available	RED	090-5020-10T
22-500	1.7 Ω	090-5017-00			090-5036-00B	22-750/30-2600 ‡	2.6 / 92.0 Ω	N/A	090-5011-00
22-600	2.2 Ω	090-5023-00	25-1240	9.3 Ω	090-5034-00	22-900 †	3.4 Ω	YEL	090-5020-20T
23-700	3.1 Ω	090-5022-00			26-1200 †	10.3 Ω	090-5044-00T	22-1080 †	4.3 Ω
23-750	3.4 Ω	090-5019-00	090-5044-00B	090-5032-00B					
23-800 †	3.6 Ω	090-5001-00T	27-1300	14.2 Ω	090-5003-00	23-620/30-2600 ‡	2.4 / 75.0 Ω	N/A	090-5006-00
		090-5001-00B	27-1400	14.7 Ω	090-5015-00	23-700/30-2600 ‡	3.0 / 83.5 Ω	N/A	090-5013-00
23-840	4.0 Ω	090-5005-00	27-1500	16.3 Ω	090-5004-00T	23-800/30-2600 ‡	2.8 / 90.5 Ω	N/A	090-5012-00
23-1200	7.1 Ω	090-5008-00			090-5004-00B	23-900	3.8 Ω	GRN	090-5020-30
23½-765	3.6 Ω	090-5037-03	28-1050	11.5 Ω	090-5046-00	23-1100	5.1 Ω	ORG	090-5030-00
24-900	5.0 Ω	090-5002-00	29-2000	33.6 Ω	090-5016-00	23-1500	4.4 Ω	BLU	090-5062-00T
						24-1570	9.5 Ω	N/A	090-5025-00
						25-1800	13.8 Ω	BLU/GRN	090-5041-00

NOTE: Ohm values may vary +/- .03 Ω depending on meter calibration.

† Coil Part N°s ending with a "T" signifies the Diode is on the top of the lug; ...ending with a "B" signifies the Diode is on the bottom of the lug.

‡ These coils are dual-wound. **Also Note:** All Coil Part N°s listed **Do Not Include** Coil Sleeves (must be ordered separately).

MAGNET COILS w/12" leads			TRIP COILS (Miniature)						LUGLESS COILS	
GA-TURNS	Res. (Ω)	SPI PART N°	GA-TURNS	Res. (Ω)	SPI PART N°	GA-TURNS	Res. (Ω)	SPI PART N°	GA-TURNS	Res. (Ω)
22-650	4.3 Ω	090-5042-01	29-1000	15.2 Ω	090-5059-00	33-1590	59 Ω	515-6916-00	SPI PART N°	
24-780	8 Ω	090-5061-00	31-1500	52.0 Ω	090-5054-00	32-1250	35 Ω	515-6916-01	23-800	3.6 Ω
20½-480	2.9 Ω	090-5064-02	32-1800	50.2 Ω	090-5031-00	Note: 33-1590 WHT & 32-1250 YEL		090-5053-00		

Flipper Coil Table † ‡

GAME NAME	N° of Flippers	LOWER FLIPPERS		UPPER FLIPPERS	
		SPI N° / GAUGE-TURNS / Color		SPI N° / GAUGE-TURNS / Color	
		LEFT	RIGHT	LEFT	RIGHT
Laser War †	2	090-5011-00 22-750 / 30-2600	SAME	Not Used	Not Used
Secret Service †	3	090-5006-00 23-620 / 30-2600	SAME	Not Used	090-5006-00 23-620 / 30-2600
Torpedo Alley †	3	090-5011-00 22-750 / 30-2600	090-5013-00 23-700 / 30-2600	Not Used	090-5012-00 23-800 / 30-2600
Time Machine †	2	090-5011-00 22-750 / 30-2600	SAME	Not Used	Not Used

† These coils are dual-wound.

Playboy 35th Anniversary ††	2	090-5020-02 22-900 -YEL-	SAME	Not Used	Not Used
ABC Monday Night Football ††	2	090-5020-02 22-900 -YEL-	SAME	Not Used	Not Used

†† A very small % of these games used a 090-5020-20 coil which used a proto-type Solid State Flipper System. The two types of coils both are 22-900 coils; the only difference being the addition of the 1N5404 Diode on the (-02) coils which was used in the Deger Design.

Robocop	2	090-5020-20 22-900 -YEL-	SAME	Not Used	Not Used
Phantom of the Opera	2	090-5020-20 22-900 -YEL-	SAME	Not Used	Not Used
Back to the Future	2	090-5020-20 22-900 -YEL-	SAME	Not Used	Not Used
The Simpsons	2	090-5020-20 22-900 -YEL-	SAME	Not Used	Not Used
Checkpoint	2	090-5020-20 22-900 -YEL-	SAME	Not Used	Not Used
Teenage Mutant Ninja Turtles	2	090-5020-30 23-900 -GRN-	SAME	Not Used	Not Used
Batman	2	090-5020-30 23-900 -GRN-	SAME	Not Used	Not Used
Star Trek 25th Anniversary	2	090-5020-30 23-900 -GRN-	SAME	Not Used	Not Used
Hook	2	090-5030-00 23-1100 -ORG-	090-5020-30 23-900 -GRN-	Not Used	Not Used
Lethal Weapon 3	2	090-5030-00 23-1100 -ORG-	SAME	Not Used	Not Used

Table continued on the next page.



APPENDIX E

Flipper Coil Table †

GAME NAME	№ of Flippers	LOWER FLIPPERS		UPPER FLIPPERS	
		SPI № / GAUGE-TURNS / Color		SPI № / GAUGE-TURNS / Color	
		LEFT	RIGHT	LEFT	RIGHT
Star Wars	2	090-5032-00 22-1080 -YEL-GRN-	SAME	Not Used	Not Used
Rocky & Bullwinkle & Friends	2	090-5020-30 23-900 -GRN-	SAME	Not Used	Not Used
Jurassic Park	3	090-5020-30 23-900 -GRN-	SAME	Not Used	090-5030-00 23-1100 -ORG-
Last Action Hero	2	090-5020-30 23-900 -GRN-	SAME	Not Used	Not Used
Tales from the Crypt	3	090-5032-00 22-1080 -YEL-GRN-	SAME	Not Used	090-5041-00 25-1800 -BLU-GRN-
The Who's Tommy	3	090-5020-30 23-900 -GRN-	SAME	090-5041-00 25-1800 -BLU-GRN-	Not Used
WWF Royal Rumble	4	090-5032-00 22-1080 -YEL-GRN-	SAME	090-5041-00 25-1800 -BLU-GRN-	SAME
Guns N' Roses	3	090-5032-00 22-1080 -YEL-GRN-	SAME	090-5030-00 23-1100 -ORG-	Not Used
Maverick	3	090-5032-00 22-1080 -YEL-GRN-	SAME	Not Used	090-5032-00 22-1080 -YEL-GRN-
Mary Shelley's Frankenstein	3	090-5030-00 23-1100 -ORG-	SAME	Not Used	090-5030-00 23-1100 -ORG-
Baywatch	4	090-5030-00 23-1100 -ORG-	090-5020-30 23-900 -GRN-	090-5025-00 24-1570 -N/A-	090-5030-00 23-1100 -ORG-
Batman Forever	3	090-5032-00 22-1080 -YEL-GRN-	090-5020-20 22-900 -YEL-	Not Used	090-5020-30 23-900 -GRN-
Apollo 13	2	090-5032-00 22-1080 -YEL-GRN-	SAME	Not Used	Not Used
Golden Eye	2	090-5032-00 22-1080 -YEL-GRN-	SAME	Not Used	Not Used
Twister	2	090-5020-20 22-900 -YEL-	090-5032-00 22-1080 -YEL-GRN-	Not Used	Not Used
ID4: Independence Day	3	090-5032-00 22-1080 -YEL-GRN-	SAME	Not Used	090-5020-30 23-900 -GRN-
Space Jam †	2	090-5032-00T 22-1080 -YEL-GRN-	090-5020-20T 22-900 -YEL-	Not Used	Not Used
The Star Wars Trilogy - Special Edition †	2	090-5032-00T 22-1080 -YEL-GRN-	SAME	Not Used	Not Used
The Lost World: Jurassic Park †	2	090-5032-00T 22-1080 -YEL-GRN-	SAME	Not Used	Not Used
The X-Files †	2	090-5032-00T 22-1080 -YEL-GRN-	SAME	Not Used	Not Used
Starship Troopers †	3	090-5030-00T 23-1100 -ORG-	SAME	Not Used	090-5032-00T 22-1080 -YEL-GRN-
Viper Night Drivin' †	2	090-5030-00T 23-1100 -ORG-	SAME	Not Used	Not Used
Lost In Space †	2	090-5030-00T 23-1100 -ORG-	090-5032-00T 22-1080 -YEL-GRN-	Not Used	Not Used
Godzilla †	2	090-5032-00T 22-1080 -YEL-GRN-	SAME	Not Used	Not Used
South Park †	2	090-5030-00T 23-1100 -ORG-	SAME	Not Used	Not Used
Harley-Davidson® †	2	090-5032-00T 22-1080 -YEL-GRN-	090-5030-00T 23-1100 -ORG-	Not Used	Not Used
Striker Xtreme (NFL) †	3	090-5032-00T 22-1080 -YEL-GRN-	090-5030-00T 23-1100 -ORG-	090-5030-00T 23-1100 -ORG-	Not Used
Sharkey's Shootout †	3	090-5030-00T 23-1100 -ORG-	090-5030-00T 23-1100 -ORG-	090-5030-00T 23-1100 -ORG-	Not Used
High Roller Casino †	2	090-5020-20T 22-900 -YEL-	090-5032-00T 23-1080 -YEL-GRN-	Not Used	Not Used
Austin Powers™ †	2	090-5020-30 23-900 -GRN-	090-5030-00T 23-1100 -ORG-	Not Used	Not Used
Monopoly® †	3	090-5032-00T 22-1080 -YEL-GRN-	090-5032-00T 22-1080 -YEL-GRN-	Not Used	090-5062-00T 23-1500 -BLU-

† Coil Part N°s ending with a "T" signifies the Diode is on the top of the lug (on the coil-winding side);
Coil Part N°s ending with a "B" signifies the Diode is on the bottom of the lugs.



APPENDIX F

Motor Specification Table

The following table only list games that used motors. *Part Numbers starting with "515-" will include the Wiring Harness & Connector.*

Game Name	Function	Specifications	Part No
ABC Monday Night Football	Goal Post Up/Down Movement	Motor 24v A.C. 60 RPM CW	515-5222-00
Phantom of the Opera	Organ Up/Down Movement	Bowman Motor 24v 60Hz 3W 11 RPM CCW	515-5256-00
Checkpoint	Mag Wheel (in Backbox)	Motor D.C. (KEN)	041-5005-00
	Shaker	Johnson Motor (Vibrator)	041-5002-00
Teenage Mutant Ninja Turtles	Spinning Pizza Ball Deflector	Gear Motor 24v A.C. 325 RPM CW	515-5397-00
Batman	Bar Target Up/Down Movement	Bowman Motor 24v 60Hz 3W 11 RPM CCW	515-5256-00
Star Trek 25th Anniversary	Swinging Target	Bowman Motor 24v 22½ RPM	515-5534-00
	Transporter F/X	Gear Motor 24v A.C. 3½ RPM	500-5421-00
	Cooling Fan (for Transporter F/X)	4½" Motor 12v	041-5014-00
Lethal Weapon 3	Spinning Light	Motor 2½ v A.C. 4000 RPM CCW	041-5017-00
Star Wars	Bar Target Up/Down Movement	Bowman Motor 24v 60hz 3W 11 RPM CCW	515-5256-00
	R2D2 Robot Left/Right Movement	Bowman Motor 24v A.C. 22½ RPM CW	515-5571-00
	Death Star Rotation	Bowman "G" Motor 24v A.C. 60Hz 6 RPM CW	515-5570-00
Rocky & Bullwinkle & Friends	Nell Log "Cutting Blade" Forward/Back Movement	Autotrol Model E Motor 24v 60hz 4W 3 RPM CCW	041-5023-00
Jurassic Park	T-Rex Left/Right Movement	Multi Motor 5v D.C.	041-5025-00
	T-Rex Up/Down Movement	Bowman Motor 24v 11 RPM CW	041-5026-00
	Shaker	Johnson Motor (Vibrator)	041-5002-00
Last Action Hero	Crane Left/Right Movement	Multi Products Motor 12v D.C. #3312 OSC	041-5027-00
	Shaker	Johnson Motor (Vibrator) 10.5v D.C. 10 AMP 2950 RPM CW	041-5029-00
Tales from the Crypt	Tombstone Up/Down Movement	Bowman Motor 24v A.C. 6 RPM CCW	515-5900-00
	Shaker	Johnson Motor (Vibrator) 10.5v D.C. 10 AMP 2950 RPM CW	041-5029-00
The Who's Tommy	Mirror Up/Down Movement	Bowman Motor 24v A.C. 6 RPM CCW	515-5900-00
	Flipper Blinders	Servo Motor (94102)	041-5032-00
	Spinning Airplane Propellers	Motor D.C.	041-5033-00
WWF Royal Rumble	Shaker	Johnson Motor (Vibrator) 10.5v D.C. 10 AMP 2950 RPM CW	041-5029-00
Maverick, The Movie	Turning Paddle Wheel	Motor 24v A.C. 10 RPM	041-5036-00
Mary Shelley's Frankenstein	Creature Head Left/Right Movement	Servo Motor (94102)	041-5032-00
Batman Forever	Cannon Left/Right Movement	Bowman Motor 24v A.C. 60Hz 3W 6 RPM CCW	515-6383-00
Apollo 13	Rocket Up/Down Movement	Bowman Motor 24v A.C. 60Hz 3W 6 RPM CCW	515-6383-00
	Moon Unit Rotational Orbit	Multi Products Motor 24v A.C. 50/60Hz 3W 6 RPM CCW	515-6487-00
	Shaker	Johnson Motor (Vibrator) 10.5v D.C. 10 AMP 2950 RPM CW	041-5029-00
Golden Eye	Satellite Left/Right Movement	Bowman Motor 24v A.C. 60Hz 3W 6 RPM CW	515-6528-00

Table continued on the next page.



APPENDIX F

Motor Specification Table

The following table only list games that used motors. Part Numbers starting with "515-" will include the Wiring Harness & Connector.

Game Name	Function	Specifications	Part №
Twister	Spinning Disc with Magnet	Multi Products Motor 24v A.C. (041-5026-00) 50/60Hz 3W 325 RPM CCW	515-6347-00
	Backbox Fan (Tornado Wind)	Multi Products Motor 24v A.C. (041-5052-00) 50/60Hz 3W 3600 RPM CW	515-6531-00
ID4: Independence Day	Alien Head Open/Close Movement	Servo Motor (94322)	041-5045-00
The Star Wars Trilogy - S.E.	X-Wing Left/Right Movement	Bowman Motor 24v A.C. (041-5058-00) 60Hz 3W 10 RPM CCW	515-6383-01
The Lost World: J.P.	Snagger & Center Link Lift Up/Down Movement	Multi Products Motor 20v D.C. (041-5059-03) 9 RPM Non-Directional	515-6715-03
	Shaker	Johnson Motor (Vibrator) 10.5v D.C. 10 AMP 2950 RPM CW	041-5029-00
The X-Files	X-File Cabinet Lift Up/Down Movement	Multi Products Motor 20v D.C. 9 RPM CCW	041-5057-00
Starship Troopers	Warrior Bug Forward/Reverse Movement	Haydon Switch & Instrument, Inc. Stepper Motor 12v D.C. 4.6W (041-5062-00), Series 36000: 1.4"Ø (Non-Captive Shaft not incl.) HSI #36864-12 (Unipolar) Travel per Step: .004 Step Angle: 15°	515-6794-00 Requires 7" Shaft: 530-5503-00
Lost In Space	Spinning Disc with Magnet	Multi Products Motor 24v A.C. (041-5046-00) 50/60Hz 3W 325 RPM CCW	515-6347-00
Godzilla	Shaker	Johnson Motor (Vibrator) 10.5v D.C. 10 AMP 2950 RPM CW ‡	041-5029-01
Harley-Davidson®	Shaker	Johnson Motor (Vibrator) 10.5v D.C. 10 AMP 2950 RPM CW ‡	041-5029-01
	Motorcycle Lift Up/Down Movement	Autotrol 24v A.C. (041-5072-01) 20 RPM CCW	515-7025-00
Striker Xtreme (NFL)	Goalie (Linebacker) Left to Right Movement	Multi #3590 12v D.C. (041-5075-00) 60 RPM	515-7071-00
Sharkey's Shootout	Mystery Ball Rotating Movement	Hanskcraft Motor Model-E 24v A.C. (041-5076-00) 50/60Hz 3W 20 RPM CW	515-7095-00
High Roller Casino	Roulette Wheel Rotating Movement	Multi Products Motor 20V D.C. (041-5078-00) 17 RPM CCW	515-7153-00
	Up/Dn. Ramp in Slot Mach. Lift Up/Down Movement	Haydon Switch & Instrument, Inc. Stepper Motor 12v D.C. 4.6W (041-5062-00), Series 36000: 1.4"Ø (Non-Captive Shaft not incl.) HSI #36864-12 (Unipolar) Travel per Step: .004 Step Angle: 15°	515-6794-00 Requires Shaft 4¼": 530-5503-01
Austin Powers™	Time Machine Rotating Movement	Multi Products Motor 24v A.C. (041-5079-00) 50/60Hz 20RPM CCW	515-7141-00
	Laser Beam Left to Right Directional	Autotrol Motor 24V A.C. (041-5081-00) 50/60Hz 4W 10RPM Bi-Directional	515-7171-00
	Dr. Evil Target Lift Up/Down Movement	Hanskcraft Motor Model-E 24v A.C. (041-5030-00) 50/60Hz 6RPM CCW	515-5900-00
Monopoly®	Mini-Flipper (Waterworks) Rotating Movement	Multi Prod. Motor & Gear Box #7000 EX00159A 20v D.C. 50/60Hz 85RPM CC/CW	041-5083-00

No motors were used on the following games: Laser War, Secret Service, Torpedo Alley, Time Machine, Playboy 35th Anniversary, Robocop, Back to the Future, The Simpsons, Hook, Guns N' Roses, Baywatch, Space Jam, Viper Night Drivin', South Park.

‡ **Please Note:** "-01" Shaker Motor is **Not Compatible** with old Shaker Motor 041-5029-00 (Shaker Motor Assy. 515-5893-00). **THIS NEW MOTOR CAN ONLY BE USED IN NEW SHAKER MOTOR ASSY. 515-5893-01.**



APPENDIX G

Part Number Prefix Classification Codes

- I. Electrical Source, Energy & Signal Converters**
 - 010- Transformers
 - 031- Speakers
 - 090- Solenoids (Coils)

- II. Conductors, Connectors & Insulators**
 - 034- Line Cords
 - 036- Cable and Harness Assemblies
 - 041- Motors
 - 045- Connectors (All Types)
 - 077- Lamp Sockets

- III. Circuits & Circuit Elements**
 - 100- ICs
 - 110- Transistors
 - 112- Diodes
 - 121- Resistors
 - 123- Resistors (Variable & Adjustable)
 - 124- Regulators & Bridge Rectifiers
 - 125- CAPS
 - 140- Crystals
 - 165- Light Bulbs
 - 180- Switches
 - 190- Relays

- IV. Bolts, Screws, Nuts & Washers**
 - 231- Bolts
 - 232- Screws (Pan Head)
 - 234- Screws (HWH)
 - 237- Screws (Misc.)
 - 240- Nuts (Misc.)
 - 242- Washers (Flat, Round)
 - 244- Washers (Split Lock)
 - 246- Washers (Lockers, External Tooth)

- V. Mechanical Components**
 - 249- Rivets
 - 251- Pins (Dowel)
 - 254- Stand-Offs, Spacers and Shims
 - 260- Steel Ball
 - 265- Springs (Extension)
 - 266- Springs (Compression)
 - 269- Springs (Washers - Belleville, Wave)
 - 280- Grommets and Bushing

- VI. Handles, Locks, Catches & Latches, Keys & Hinges**
 - 355- Handles, Locks, Catches & Latches and Keys
 - 390- Hinges

- VII. Fabricated Parts (In-House Assemblies)**
 - 500- End Product (Systems and Models)
 - 515- Sub-Assemblies
 - 520- Printed Circuit Boards (PCBs)
 - 522- Display Glass
 - 525- Wood Parts
 - 530- Screw Machined Parts
 - 535- Fabricated Parts
 - 545- Molded (Extruded) Plastic/Rubber Parts
 - 550- Molded (Inserts)













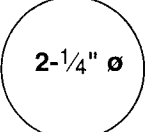
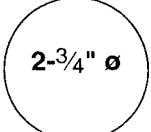
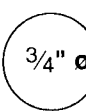
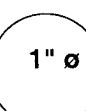
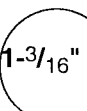
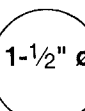
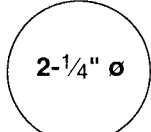
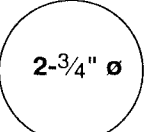
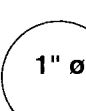
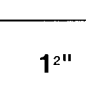

- VIII. Bulk Materials**
 - 600- Braided Ground Wire
 - 601- Stranded Wire
 - 602- Ribbon Cable
 - 605- Sleeving (Shrink Tubing)
 - 626- Foam Rubber

- IX. Miscellaneous**
 - 705- Packing & Shipping Items
 - 820- Decals and Labels (Sets & Misc.)
 - 830- Butyrate (Plastic Pieces)
 - 900- Game Posters
 - 960- EPROM (Raw Part)
 - 965- EPROM (Programmed Part)

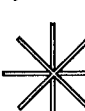
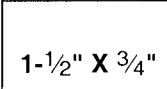
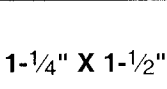
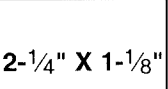
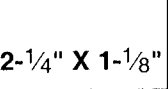
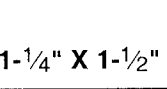
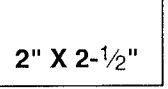

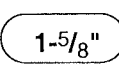
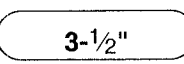
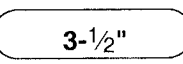
APPENDIX H

Playfield Inserts (Plastic Light Covers)

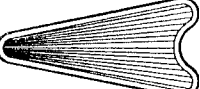
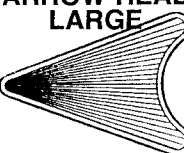
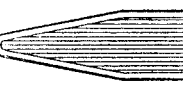
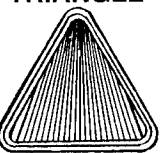
Patterns: STARBURST  STIPPLE 	STARBURST CIRCULAR  550-5000-XX	STARBURST CIRCULAR  550-5001-XX	STARBURST CIRCULAR  550-5002-XX	STARBURST CIRCULAR  550-5003-XX	STARBURST CIRCULAR  550-5004-XX
STARBURST CIRCULAR  550-5005-XX	STARBURST CIRCULAR  550-5006-XX	PLAIN CIRCULAR  550-5007-XX	PLAIN CIRCULAR  550-5008-XX	PLAIN CIRCULAR  550-5009-XX	PLAIN CIRCULAR  550-5010-XX
PLAIN CIRCULAR  550-5011-XX	PLAIN CIRCULAR  550-5012-XX	STIPPLE CIRCULAR  550-5048-XX	STIPPLE 1" SQUARE  550-5019-XX	ROLLOVER BUTTON BASE  550-5026-XX	WHITE STAR (only in white)  545-5015-00
STIPPLE RECTANGULAR  550-5018-XX	STIPPLE RECTANGULAR  550-5051-XX	STARBURST RECTANGULAR  550-5044-XX	PLAIN RECTANGULAR  550-5049-XX	PLAIN RECTANGULAR  550-5050-XX	PLAIN RECTANGULAR  550-5063-XX
STARBURST MINI SHIELD  550-5024-XX	STARBURST LARGE SHIELD  550-5025-XX	MINI HOT DOG  550-5020-XX	BEVEL HOT DOG  550-5021-XX	PLAIN HOT DOG  550-5022-XX	BANANA  550-5023-XX
STARBURST ARROW-SMALL  550-5013-XX	STARBURST ARROW-LARGE  550-5070-XX	STARBURST ARROW-HEAD SMALL  550-5014-XX	STARBURST ARROW-HEAD LARGE  550-5015-XX	STARBURST BULLET  550-5016-XX	STARBURST TRIANGLE  550-5017-XX

Note: The shapes and sizes shown above are not to scale. Some shapes may no longer be available in every color.

Instructions: Parts which may come in various colors (i.e. targets, some posts, playfield inserts, etc.) end in a 2-digit N^o which correspond to the color of that part. The "-XX" in Part N^os which may come in various colors should be replaced with the desired 2-Digit N^o. corresponding to the color desired. *Not all colors may be available.*

P L A S T I C P A R T C O L O R C H A R T											
N ^o	Color	N ^o	Color	N ^o	Color	N ^o	Color	N ^o	Color	N ^o	Color
-00	Black or Solid Clear	-03	Amber	-06	Yellow	-09	Purple	-12	Fluor. Blue	-15	Luminescent
-01	Clear	-04	Green	-07	Orange	-10	Fluor. Orange	-13	Teal Green	-16	Gold
-02	Red	-05	Blue	-08	White	-11	Fluor. Green	-14	Gray	-17	Trans. Brown

APPENDIX I

Stand-Up Targets

PLASTIC PART COLOR CHART	
Nº	Color
-00	Black
-01	Clear
-02	Red
-03	Amber
-04	Green
-05	Blue
-06	Yellow
-07	Orange
-08	White
-09	Purple
-10	Fluor. Orange
-11	Fluor. Green
-12	Fluor. Blue
-13	Teal Green
-14	Gray
-15	Luminescent
-16	Gold

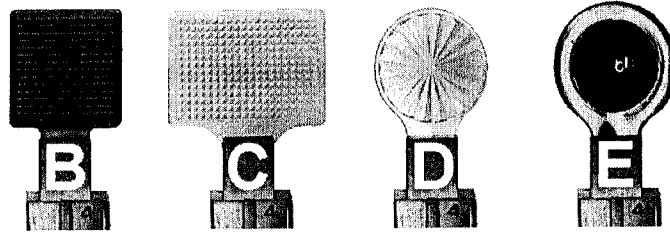
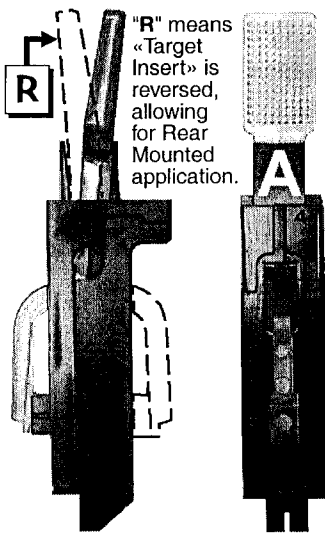

Take Note:

- For Items A-E, for the Target Assembly use the "500-" SPI Nº; For the Target Assy. with Rear Mount add "R" to "500-" SPI Nº; For just the «Target Insert» use the "545-" SPI Nº.
- Items A-E come in various colors. *These targets may not be available in every color.* The "-XX" in should be replaced with the desired 2-Digit Nº for the color desired described in the Chart ↗.
As of date of print, the following colors were used for Items A-E:
-01 Clear (A, D); -02 Red (A, B, C, D, E); -03 Amber (D, E); -04 Green (A, B); -05 Blue (C); -06 Yellow (A, C); -09 Purple (B, D); -11 Fluorescent Green (A, B, D).
- See Section 3, Chapter 2, Go To Diagnostics Menu, for switches used corresponding to the Switch Matrix Grid of this game.

Nº	STAND-UP TARGET NAME	SPI PART Nº	Nº	STAND-UP TARGET NAME	SPI PART Nº
A	Modular Stand-Up Target Narrow Assy.	500-6138-XX	D	Modular Stand-Up Target Round Assy.	500-6075-XX
	Stand-Up Target Narrow (Insert)	545-6138-XX		Stand-Up Target Round (Insert)	545-6075-XX
B	Modular Stand-Up Target Square Assy.	500-6139-XX	E	Mod. Stand-Up Target 1" Spherical Assy.	500-6189-XX
	Stand-Up Target Square (Insert)	545-6139-XX		Stand-Up Target 1" Spherical (Insert)	545-6189-XX
C	Modular Stand-Up Target Rectangle Assy.	500-6228-XX	NOTE: To receive the Target Assy. with the « Target Insert » « Reversed » simply add a "R" at the end of the Part Nº. See Side View picture above to compare (dashed line shows target reversed).		
	Stand-Up Target Rectangle (Insert)	545-6228-XX			

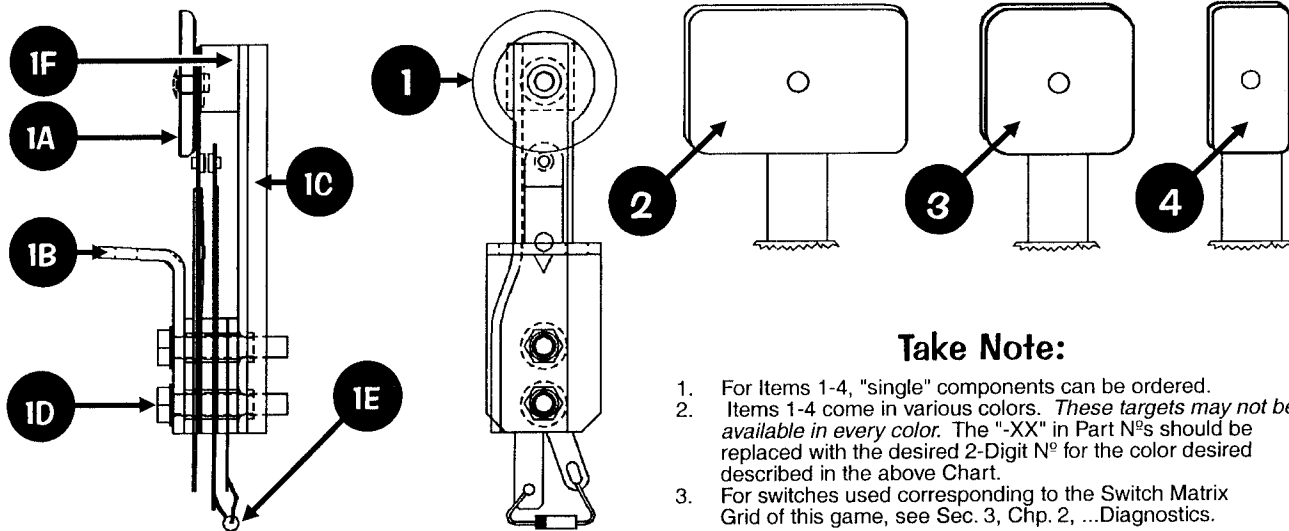

Take Note:

- For Items 1-4, "single" components can be ordered.
- Items 1-4 come in various colors. *These targets may not be available in every color.* The "-XX" in Part Nºs should be replaced with the desired 2-Digit Nº for the color desired described in the above Chart.
- For switches used corresponding to the Switch Matrix Grid of this game, see Sec. 3, Chp. 2, ...Diagnostics.

Nº	STAND-UP (FLAT) TARGET NAME	SPI PART Nº	Nº	STAND-UP (FLAT) TARGET NAME	SPI PART Nº
1	1" Round Stand-Up Target Assy.	500-5835-XX	3	1" Sq. Stand-Up Target Assy.	500-5232-XX
ORDERING ABOVE (ITEM 1) ASSY. PART Nº WILL INCLUDE: 1A‡ Switch & Target Assy. 1" Round 1B Mounting Bracket 1C Switch Back Plate 1D 6-32 X 3/4 HWH Swage (Qty. 2) 1E Switch Diode, 1N4001 1F Foam Pad			ORDERING ABOVE (ITEM 3) ASSY. PART Nº WILL INCLUDE: 3A‡ Sw. & Target Assy. 1" Square Items 3B-F are identical to 1B-F		
‡ Note: Item 1A, is a riveted Sub-Assy. which includes the following items for reference: A1— Stack Switch Radius End (180-5133-00), A2— Washer 5/16" (242-5017-00), A3— Rivet 1/8" ø X 3/16" (249-5001-00) and A4— 1" Round Target (545-5456-XX).			‡ Note: Item 3A, is a riveted Sub-Assy. which includes the following items for reference: A1— Stack Switch Radius End (180-5133-00), A2— Washer 5/16" (242-5017-00), A3— Rivet 1/8" ø X 3/16" (249-5001-00) and A4— 1" Square Target (545-5470-XX).		
2	1" X 1 1/2" Stand-Up Rect. Target Assy.	500-5321-XX	4	Narrow Stand-Up Target Assy.	500-5857-XX
ORDERING ABOVE (ITEM 2) ASSY. PART Nº WILL INCLUDE: 2A‡ Sw. & Target Assy. 1" X 1 1/2" Rect. Items 2B-F are identical to 1B-F			ORDERING ABOVE (ITEM 4) ASSY. PART Nº WILL INCLUDE: 4A‡ Sw. & Target Assy. Narrow Items 4B-F are identical to 1B-F		
‡ Note: Item 2A, is a riveted Sub-Assy. which includes the following items for reference: A1— Stack Switch Square End (180-5132-00), A2— Washer 5/16" (242-5017-00), A3— Rivet 1/8" ø X 3/16" (249-5001-00) and A4— Narrow Target (545-5210-XX).			‡ Note: Item 4A, is a riveted Sub-Assy. which includes the following items for reference: A1— Stack Switch Square End (180-5132-00), A2— Washer 5/16" (242-5017-00), A3— Rivet 1/8" ø X 3/16" (249-5001-00) and A4— Narrow Target (545-5210-XX).		

Item 2 Table Note continued in the next column.



GLOSSARY OF TERMS

- A** Followed after a number means "Amp." or Ampage in an expression relating to an electrical object. (e.g. 8A).
- AC** (Acronym) **Alternating Current**.
- Adj.** (Abbreviation) Adjustment(s).
- Assy.** (Abbreviation) Assembly.
- Au.** (Abbreviation) Audit(s).
- Bd.** (Abbreviation) Board.
- BOT** (Abbreviation) Bottom.
- Brkt.** (Abbreviation) Bracket.
- Bridge Rectifier** A configuration of a diode that allows current to flow in one direction producing both positive and negative pulsating DC Voltages.
- Color Coding** See Appendix H or I, Plastic Part Color Chart or Section 4, Chapter 1, Playfield - Plastic Posts & Spacers.
- Combination (Combo) [Shot]** Any variable pinball shot(s) made successively.
- Conn.** (Abbreviation) Connector.
- CMOS** Short for COSMOS (Complementary Symmetry M.O.S.); Complementary Metal-Oxide Semi-Conductor.
- CN** (Abbreviation) Connector (e.g. CN5-P3).
- CT** (Abbreviation) Center.
- DC** (Abbreviation) Direct Current.
- DT** (Abbreviation) Drop Target(s).
- DOTS** (Acronym) **Diode On Terminal Strip**.
- EB** (Abbreviation) Extra Ball.
- Eject** Playfield surface device to kick ball back into play; Saucer.
- EPROM** (Acronym) **Erasable Programmable Read Only Memory**. Can be erased using UV Light and re-programmed.
- e.g. (Abbreviation) Latin- Exempla gratia. For Example.
- EOS** (Acronym) **End-Of-Stroke** (i.e. Switch for flipper).
- F** (Abbreviation) Fuse (i.e. F23).
- GA-Turn** Gauge & Turn describing the windings on a coil (e.g. 23-800, 23 is the gauge of wire and 800 is the amount of windings).
- G.I.** (Abbreviation) General Illumination (Lamps).
- HWH** (Abbreviation) Hex Washer Head.
- IC** (Acronym) **Integrated Circuit** (As in after 24-Pin IC).
- ID or I.D.** (Acronym) **Inside Dimension**.
- i.e. (Abbreviation) Latin- Id est. That is.
- IO or I/O** (Abbreviation) Input / Output (e.g. I/O Power Driver Bd.)
- LT, Lt. or L.** (Abbreviation) Left.
- Laser Kick** A coil/plunger used above the playfield to kick pinball back into play.
- LED** (Acronym) **Light Emitting Diode**.
- Loop [Shot]** Continuously up a ramp and back to the flipper.
- Lwr.** (Abbreviation) Lower.
- Orbit [Shot]** From the left or right flipper around the back rail of the playfield back to the flipper.
- MB** (Abbreviation) Magnet Board.
- M-BALL or MBALL** (Abbreviation) Multiball™ More than 1 ball in game play.
- MID** (Abbreviation) Middle
- Non-Reflexive** See Reflexive.
- No. or N° or #** (Abbreviation) Number
- NPF** (Acronym) **No Problem Found**.
- N.C. or NC** (Abbreviation) Normally Closed.
- N.O. or NO** (Abbreviation) Normally Open.
- NS** (Abbreviation) Not Stuffed. (Use in Part Listings, Sec. 5)
- OD or O.D.** (Abbreviation) Outside Dimension.
- P** (Abbreviation) Pin (e.g. CN5-P3).
- PCB** (Acronym) **Printed Circuit Board**.
- P/F** (Abbreviation) Playfield.
- PIA LED** (Acronym) **Peripheral Interface Adapter Light Emitting Diode**. This is a diagnostic LED on the CPU; it should not be lit during normal operation of a pinball game.
- Plumb Bob Tilt** Weight on Tilt Assembly.
- PPH** (Abbreviation) Phillips Pan Head.
- Pop(s)** Another term for Turbo Bumper(s).
- PPB** (Acronym) Playfield Power Board ("Popcorn-Popping Bd.").
- PREV** (Abbreviation) Previous.
- PSB** (Abbreviation) Power Supply Board
- RAM** (Acronym) **Random Access Memory**. RAM can store input instructions and supply output information.
- Reflexive/Non-Reflexive Reflexive**—Solenoid Drive Transistor is enabled directly by a switch closure on the (Relating to CPU Boards) solenoid assembly (Ver. 1/2).
- Non-Reflexive**—Solenoid Drive Transistor is enabled by the CPU after reading a switch closure in the Switch Matrix (Ver. 3). Also note: All CPU Boards are backwards compatible (e.g. Jurassic Park/Ver. 3 to Time Machine/ Ver. 2). Swapping a Ver. 2 Board to a Ver. 3 is not possible due to the special solenoids section (i.e. Slingshots, Turbo Bumpers, etc.) changing from **REFLEXIVE** to **NON-REFLEXIVE** on Ver. 3 Boards.
- Relay** An automatic switch operated by current in a coil.
- ROM** (Acronym) **Read Only Memory**. ROM cannot store input instructions but can supply output information. ROM can be programmed only once.
- RMA** (Abbreviation) Return Merchandise Authorization Number
- RT, Rt. or R.** (Abbreviation) Right; ("R" at the end of Target Assy. Part N° signifies Target Insert is Reversed.)
- RO** (Abbreviation) Rollover (switches).
- Saucer** See Eject.
- Scoop** A hole into the playfield. A metal scoop is in place to guide the ball into the kick-back under the playfield.
- Slam Tilt** A switch which closes when the game is slammed into or the Coin Door is slammed shut. Depending on adjustable settings, will cancel game in play when the number of closures required is achieved.
- SMB** (Abbreviation) Shaker Motor Board.
- Solenoid** A coil used for Electro Magnetic devices such as relays, flippers, slingshots, etc.
- SSFB** (Abbreviation) Solid State Flipper Board.
- STEP** Refers to the service switches on the coin door.
- Sub-Assy.** (Abbreviation) Sub-Assembly.
- S-U or S/U** (Abbreviation) Stand-Up (targets).
- TM** (Abbreviation) Trademark
- Transfer [Shot]** Maneuvering the ball in play from one flipper to the other. With flipper in the up position and the ball cradled by that flipper one would activate the flipper button in a quick repetitive manner to bounce the ball to the other side. Skilled players can rebound the ball off the slingshot.
- Tri-Ball** Three balls in play.
- TTL** (Abbreviation) Transistor-Transistor Logic
- Upr.** (Abbreviation) Upper.
- V or v** (Abbreviation) Volt(s).
- Ver.** (Abbreviation) Version.
- VUK** (Acronym) **Vertical Up-Kicker** (Super or Standard).
- X** (Abbreviation) "Times" A multiplier; also used in dimensions.
- X-Ball** An undetermined number of ball(s) during game play.
- Zener Diode** A semi-conductor diode used for voltage regulation. Application depends on reverse break-down voltage.
- "-00B" "B" at the end of Coil Part Numbers signifies that the diode is attached to the bottom of the lug.
- "-00T" "T" at the end of Coil Part Numbers signifies that the diode is attached to the top of the lug (the side nearest the coil-winding).

STERN™ PINBALL, INC. LIMITED WARRANTY

STERN PINBALL, INC., ("SELLER") WARRANTS ONLY TO THE INITIAL PURCHASER OF ITS PRODUCTS THAT THE ITEMS LISTED BELOW ARE FREE FROM DEFECTS IN MATERIAL AND WORKMANSHIP UNDER NORMAL USE AND SERVICE FOR THE WARRANTY PERIOD SPECIFIED:

PRINTED CIRCUIT BOARDS (GAME LOGIC):	2 MONTHS
DOT MATRIX DISPLAY BOARDS:	9 MONTHS

NO OTHER PARTS OF SELLER'S PRODUCT ARE WARRANTED.

WARRANTY PERIODS ARE EFFECTIVE FROM THE INITIAL DATE OF SHIPMENT FROM SELLER TO ITS AUTHORIZED DISTRIBUTORS.

SELLER'S SOLE LIABILITY SHALL BE, AT ITS OPTION, TO REPAIR OR REPLACE PRODUCTS WHICH ARE RETURNED TO SELLER DURING THE WARRANTY PERIODS SPECIFIED, PROVIDED:

1. SELLER IS NOTIFIED PROMPTLY UPON DISCOVERY BY PURCHASER THAT STATED PRODUCTS ARE DEFECTIVE.
2. SUCH PRODUCTS ARE PROPERLY PACKAGED AND THEN RETURNED FREIGHT PREPAID, TO SELLER'S PLANT.

THIS WARRANTY DOES NOT APPLY TO ANY PARTS DAMAGED DURING SHIPMENT AND/OR DUE TO IMPROPER HANDLING, OR DUE TO IMPROPER INSTALLATION OR USAGE, OR ALTERATION. IN NO EVENT SHALL THE SELLER BE LIABLE FOR ANY ANTICIPATED PROFITS, LOSS OF PROFITS, LOSS OF USE, ACCIDENTAL OR CONSEQUENTIAL DAMAGES OR ANY OTHER LOSSES INCURRED BY THE CUSTOMER IN CONNECTION WITH THE PURCHASE OF A STERN PINBALL, INC. PRODUCT.

WARRANTY DISCLAIMER

EXCEPT AS SPECIFICALLY PROVIDED IN A WRITTEN CONTRACT BETWEEN SELLER AND PURCHASER, THERE ARE NO OTHER WARRANTIES, EXPRESS OR IMPLIED, INCLUDING ANY IMPLIED WARRANTIES OF MERCHANTABILITY OR FITNESS FOR A PARTICULAR PURPOSE.

CAUTIONS, WARNINGS & NOTICES

Caution

 FOR SAFETY AND RELIABILITY, SUBSTITUTE PARTS AND EQUIPMENT MODIFICATIONS ARE NOT RECOMMENDED (AND MAY VOID ANY WARRANTIES). USE OF NON-STERN PINBALL INC. PARTS OR MODIFICATIONS OF GAME CIRCUITRY, MAY ADVERSELY AFFECT GAME PLAY, OR MAY CAUSE INJURIES. TRANSPORT PINBALL GAMES WITH HINGED BACKBOX IN THE DOWN POSITION ONLY! ALWAYS TAKE GREAT CARE WHEN SERVICING ANY GAME. ALWAYS READ THE SERVICE MANUAL BEFORE REPLACING OR SERVICING COMPONENTS. SUBSTITUTIONS OF PARTS OR EQUIPMENT MODIFICATIONS MAY VOID FCC TYPE ACCEPTANCE.



Always Disconnect The Line Voltage Before Servicing. Some Parts May Still Hold Current When Unplugged.

Warning

 THIS EQUIPMENT GENERATES, USES, AND CAN RADIATE RADIO FREQUENCY ENERGY, AND IF NOT INSTALLED AND USED IN ACCORDANCE WITH THE INSTRUCTIONS MANUAL, MAY CAUSE INTERFERENCE TO RADIO COMMUNICATIONS. IT HAS BEEN TESTED AND FOUND TO COMPLY WITH THE LIMITS FOR A CLASS A COMPUTING DEVICE PURSUANT TO SUBPART J OF PART 15 OF FCC RULES, WHICH ARE DESIGNED TO PROVIDE REASONABLE PROTECTION AGAINST SUCH INTERFERENCE WHEN OPERATED IN A COMMERCIAL ENVIRONMENT. OPERATION OF THIS EQUIPMENT IN A RESIDENTIAL AREA IS LIKELY TO CAUSE INTERFERENCE IN WHICH CASE THE USER AT HIS OWN EXPENSE WILL BE REQUIRED TO TAKE WHATEVER MEASURES MAY BE REQUIRED TO CORRECT THE INTERFERENCE.

RF INTERFERENCE NOTICE, CABLE HARNESS PLACEMENTS AND GROUND STRAP ROUTING ON THIS GAME HAVE BEEN DESIGNED TO KEEP RF RADIATION AND CONDUCTION WITHIN LEVELS ACCEPTED BY THE FCC RULES. TO MAINTAIN THESE LEVELS, REPOSITION HARNESSES AND RECONNECT GROUND STRAPS TO THEIR ORIGINAL PLACEMENTS, IF THEY BECOME DISCONNECTED DURING MAINTENANCE.

Notices

THIS DOCUMENT AND THE DATA DISCLOSED HEREIN OR HERewith IS NOT TO BE REPRODUCED (EXCEPT WHERE NOTED), USED OR OTHERWISE DISCLOSED IN WHOLE OR IN PART TO ANYONE WITHOUT WRITTEN CONSENT OF STERN PINBALL, INC.. WARNING: PRODUCTS IN THIS MANUAL, THE COMPANY NAME AND DEVICES AND THE DESIGN OF THE MANUAL ITSELF, ARE PROTECTED BY FEDERAL PATENTS (AND PATENTS PENDING), DESIGN REGISTRATIONS, TRADEMARKS AND COPYRIGHTS. ACTION WILL BE TAKEN IN THE EVENT OF INFRINGEMENT OR IMITATION. THE RIGHT IS RESERVED TO CHANGE SPECIFICATIONS WITHOUT PRIOR NOTICE.

© 2001 Manufactured by Stern™ Pinball, Inc.
Portals, Icon Designs, logos, names, characters, & all related indicia are trademarks of Stern™ Pinball, Inc.
© 2001. All Rights Reserved.

"Multiball" is a registered trademark of
Williams Electronics Games, Inc. Used by permission.



Own it all, MONOPOLY name and logo, the distinctive design of the game board, the four corner squares, the Mr. Monopoly name and character, as well as each of the elements of the board and the game pieces are trademarks of Hasbro for its property trading game and game equipment. © 2001 Hasbro, Inc. All Rights Reserved. Licensed by Hasbro Consumer Products, a division of Hasbro, Inc.

▼ U.S. ▼
Customary
Inch Ruler



Metric Conversion

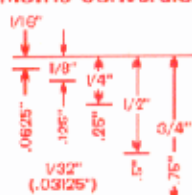

1" = 2.54cm / 25.4mm
1cm = .3937"
1mm = .03937"

For metric, multiply inch value by metric value,
e.g. 6" X 2.54cm = 15.24cm or 152mm.
For US, multiply metric value by inch value,
e.g. 13cm X .3937" = 5.1181"

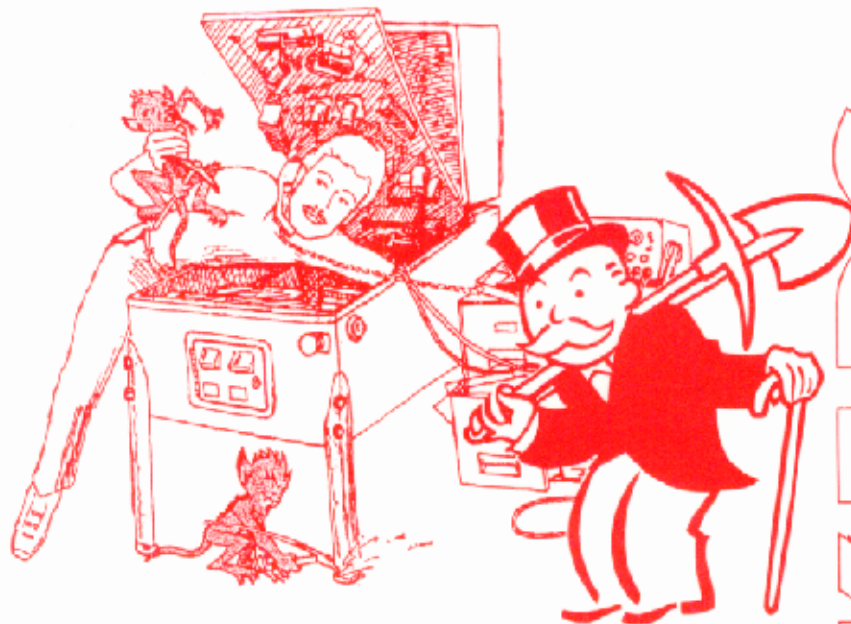

WE ARE THE WORLD'S ONE AND ONLY MANUFACTURER OF PINBALL MACHINES!

Stern Pinball, Inc.™
2020 Janice Avenue
Melrose Park IL 60160
ph. 708-345-7700
fax 708-345-7813

<http://www.SternPinball.com>

Visit our website for more current game information, Distribution Lists, Articles, Contact Information, and check out Technical Support & Part Sales for a whole lot more! **HELP US, HELP YOU!** If you have any suggestions, questions, need technical advice, find errors or have comments, contact us through our website or simply call us!

ALTHOUGH EVERY EFFORT IS PUT INTO MAKING THIS MANUAL (AND ALL OTHER DOCUMENTS RELATING TO THIS PRODUCT) BE ACCURATE AND COMPLETE, PLAYFIELD COMPONENTS, FEATURES, RULES, PROGRAMMING AND OPERATION ARE SUBJECT TO CHANGE WITH OR WITHOUT NOTICE.



2020 Janice Avenue, Melrose Park, IL 60160

1-800-780-0000

Tel 708-345-7700 (Option 1) Fax 708-345-7889 eMail parts.service@SternPinball.com

