

Instruction Manual for **STRATO-FLITE**



Williams ELECTRONICS

A DIVISION OF THE SEEBURG CORPORATION OF DELAWARE

3401 N. California Ave.
(312) 267-2240

AUGUST
1974

Chicago, Ill. 60618, U.S.A.
Cable Address: Wilcoln

STRATO FLITE

4 PLAYER

GAME OPERATES AS FOLLOWS:

MAKING 3 LETTERS IN A LETTER GROUP, EXAMPLE- 3 A's, LITES A STAR.

LITING 1 STAR DOUBLES BONUS VALUE. LITING 2 STARS TRIPLES BONUS VALUE AND LITES LEFT BOTTOM (INSIDE) ROLL-OVER LANE TO SCORE EXTRA BALL. LITING ALL FOUR STARS WILL LITE CENTER TARGET "SPECIAL" LITE.

HITTING CENTER TARGET WHEN LIT FOR "SPECIAL" SCORES 1 OR 2 REPLAYS OR 1 EXTRA BALL. (SEE "EXTRA BALL ADJUSTMENT JACK" AND "CENTER TARGET ADJUSTMENT JACK" ON PAGE 5.

1 REPLAY FOR EACH PLAYER MATCHING LAST TWO NUMBERS ON SCORE REELS TO LITED NUMBER THAT APPEARS ON BACK GLASS WHEN GAME IS OVER.

MAXIMUM 1 EXTRA BALL PER BALL IN PLAY.

TILT PENALTY--- BALL IN PLAY.

TILT DOES NOT DISQUALIFY PLAYER.

"STRATO FLITE"

ADDITIONAL CIRCUIT FOR 1 COIN 1 PLAY & 2 COINS 3 PLAYS

WHEN IN "ON" POSITION

IMPORTANT: WHEN IN "ON" POSITION, 10¢ ADJUSTMENT MUST BE IN # 2 POSITION AND 25¢ ADJUSTMENT IN # 6 POSITION

-BLACK-

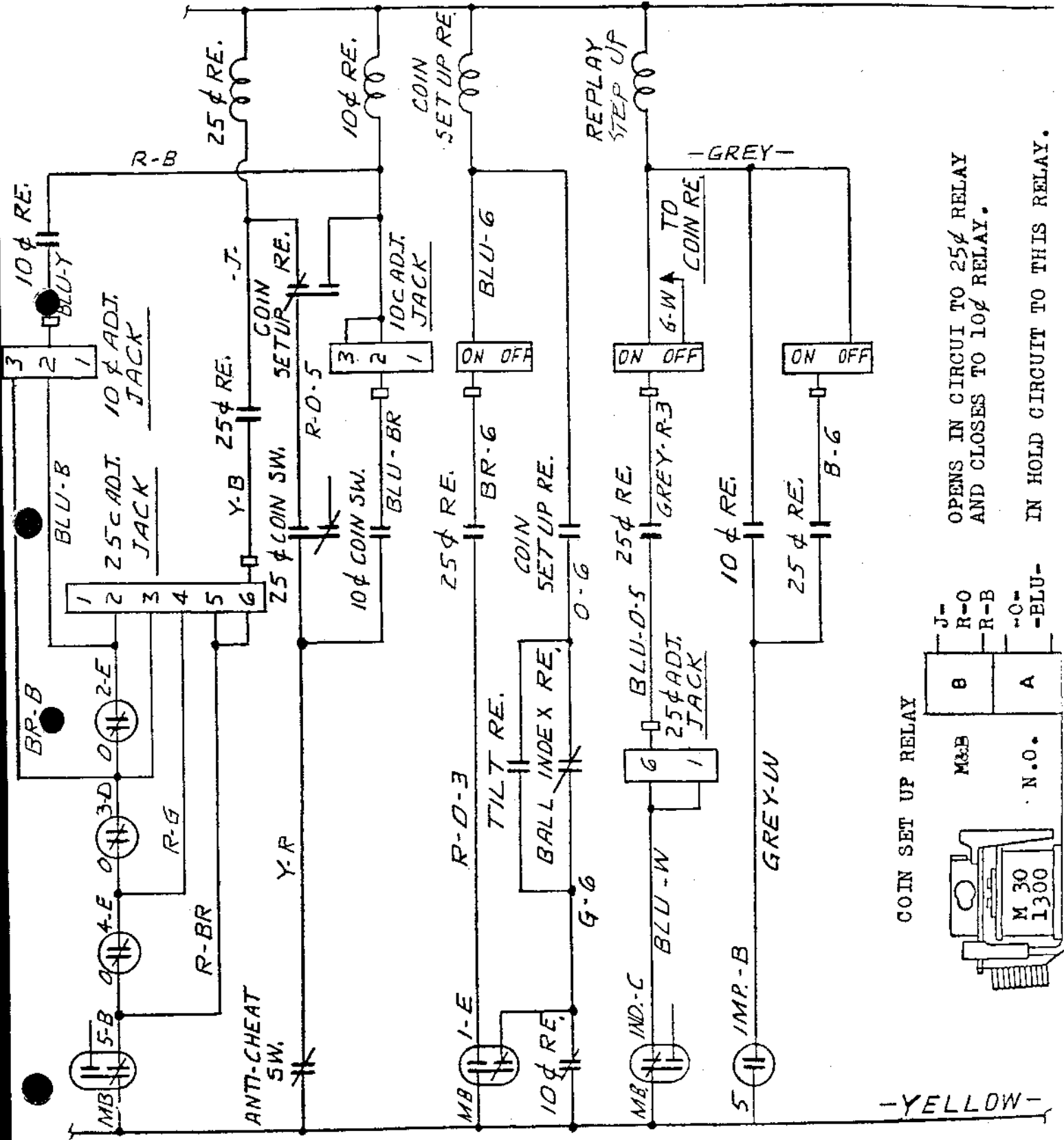

OPENS IN CIRCUIT TO 25¢ RELAY AND CLOSSES TO 10¢ RELAY.

IN HOLD CIRCUIT TO THIS RELAY.

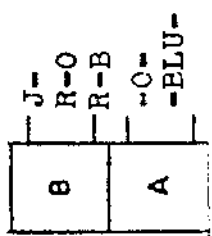

COIN SET UP RELAY

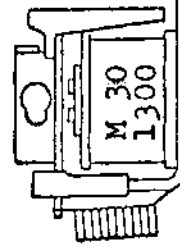

-YELLOW-

1. GENERAL

NEVER EXPERIMENT with any of the mechanism. Locate any trouble with the aid of Wiring Diagrams or Operating & Servicing Information supplied with the machine, then check for proper adjustment of the units involved before making any changes. Improper adjustment or make-shift repair will only cause serious damage to other parts of the machine or repeated failure of the part.

NOTE: Always look for a possible loose wire, bad connection at a plug and socket, broken or unhooked springs on step-up units, relays, etc., before adjustments are made or wires reconnected.

2. FUSES

IMPORTANT: Never replace fuses with any rating other than specified on the fuse block; this block is located adjacent to the transformer.

3. LUBRICATION

Over-lubrication causes far more trouble in coin operated equipment than under-lubrication. Practically all cases of poor contact on switches and wiper discs are due to oil or grease, or oil vapor, which forms a film or residue on the contacts and will not allow current to pass through. Excess lubricant may also seep into clutches causing them to slip.

IMPORTANT: NEVER USE VASELINE FOR LUBRICATION OF ANY PART OF THE MACHINE. Vaseline is not a true lubricant. It leaves a dirty and gummy residue and it becomes very thick when cold. A special Coin Machine Lubricant is supplied with each machine.

STEP-UP Levers, Ratchets, Cams, Shafts and other sliding or oscillating parts should be very lightly greased with special Coin Machine Lubricant (supplied with machine) not oftener than every six months. The bakelite discs (biscuits) on the Motor Units and Step-up Units will require lubrication with the special Coin Machine Lubricant only after the grease is completely evaporated (3 to 12 months, depending on climate) or when the film of grease becomes dirty. In either event, clean the parts thoroughly with a solvent, then apply an extremely thin coat of the special grease.

Solenoid plungers should not have a lubricant of any kind. Should there be a sluggish tendency or if plungers are sticking, the parts should be cleaned with a solvent and flaked graphite applied on reassembly.

SWITCH ADJUSTMENT

BEFORE ADJUSTING SWITCHES, MAKE CERTAIN THE SCREWS HOLDING THE SWITCH STACKS ARE DOWN TIGHTLY. BAKELITE SPACERS IN THE SWITCH STACKS, DUE TO EXCESSIVE MOISTURE, HAVE OCCASIONALLY SHRUNK BY DRYING OUT, CAUSING POOR ADJUSTMENT.

SILICON BRIDGE RECTIFIER

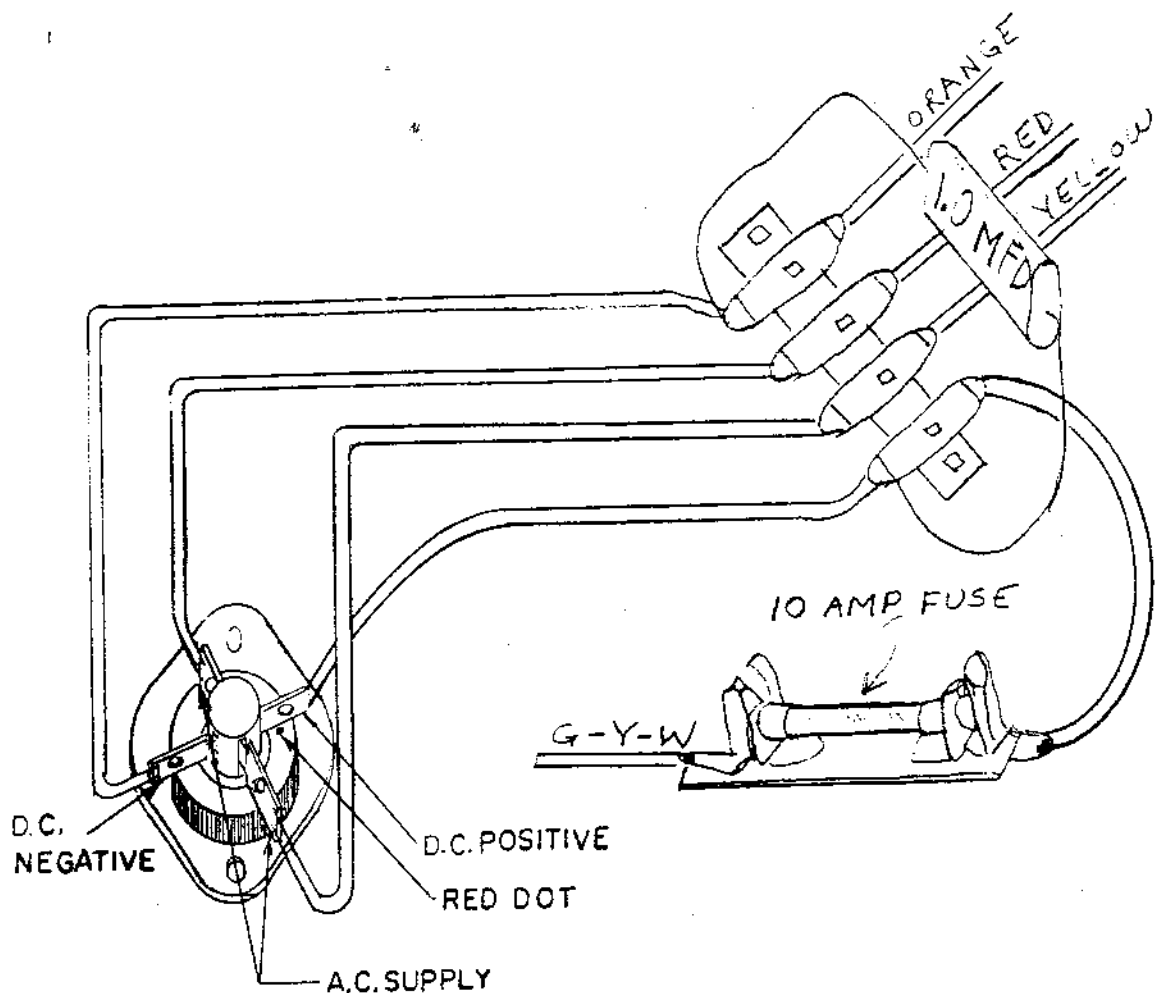

THE FUNCTION OF THE RECTIFIER AND CAPACITOR IS TO CONVERT THE ALTERNATING CURRENT (A.C.) TO DIRECT CURRENT (D.C.), SUPPLYING D.C. TO THE BUMPERS, KICKERS ETC.

THE BRIDGE RECTIFIER SHOULD PRACTICALLY NEVER NEED REPLACING, AS IT IS RATED WELL OVER THE VOLTAGE AND CURRENT REQUIREMENTS OF THE COMPONENTS IT SUPPLIES.

IF, HOWEVER, THE 15 AMP 24 VOLT FUSE ON THE MECHANISM PANEL OPENS, IT COULD BE DUE TO A FAULTY RECTIFIER. DISCONNECT THE A.C. INPUT TO RECTIFIER, REPLACE FUSE, AND RECHECK.

IF THE 10 AMP FUSE LOCATED NEXT TO THE RECTIFIER OPENS, CHECK ALL D.C. COMPONENTS I.E. BUMPERS, KICKERS ETC. FOR SHORTS.

ADJUSTMENTS ON MECHANISM PANEL

10¢ Adjustment

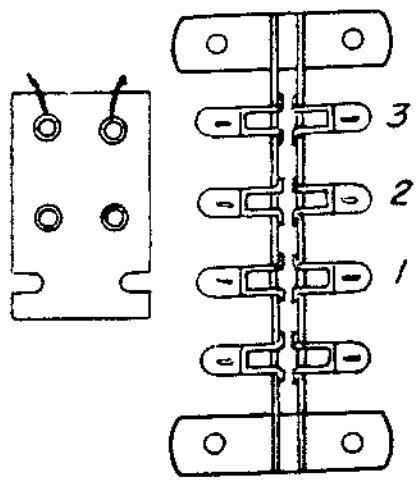

PROVIDES
1, 2 OR
3 PLAYS
FOR ONE
COIN.

5¢ Adjustment

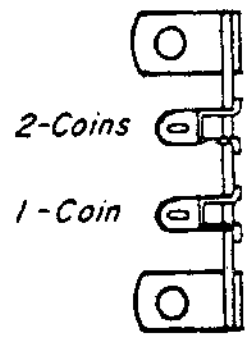

IN "2 COINS FOR
1 PLAY", CIRCUIT
TO COIN RELAY
PASSES THRU SW.
ON ALTERNATOR
UNIT.

25¢ Adjustment

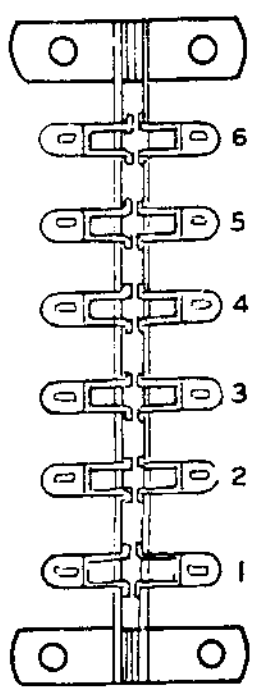

PROVIDES 1, 2, 3, 4, 5
OR 6 PLAYS FOR 25¢.

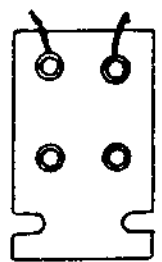

Motor Service Jack

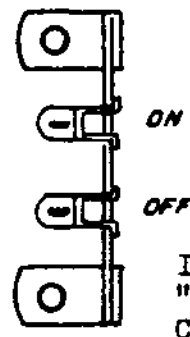

INSERT PHONE TIP IN
"OFF" POSITION - CAMS
CAN BE TURNED BY HAND
TO CHECK ADJUSTMENT OF
SWITCHES.

1 COIN- 1 PLAY
2 COINS- 3 PLAYS

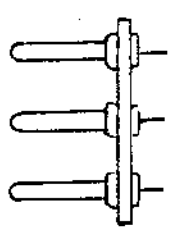
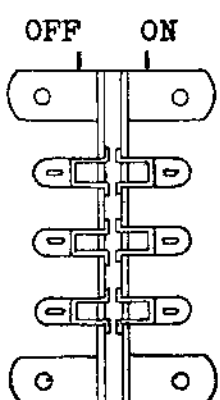

SEE PAGE 1 FOR
EXPLANATION &
CIRCUITRY.

MASTER ON-OFF SW.

(Located under front of
Cabinet)

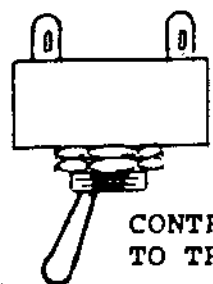

CONTROLS POWER
TO TRANSFORMER

Hi-Score Adjustment

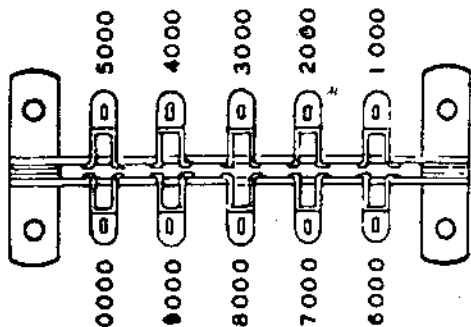

Insert plugs into 10 Point Female at desired positions.

Examples:

Yellow wire into 3000 position scores at 33000.
 Yellow wire into 0000 position scores at 40000.

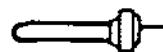
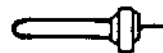
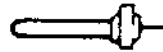
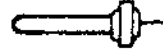
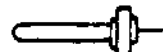
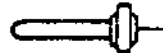
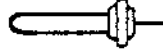
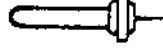
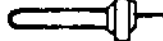
-  -RED- (11000 to 20000)
-  -BLUE- (21000 to 30000)
-  -YELLOW- (31000 to 40000)
-  -GREEN- (41000 to 50000)
-  -WHITE- (51000 to 60000)
-  -BROWN- (61000 to 70000)
-  -ORANGE- (71000 to 80000)
-  -BLACK- (81000 to 90000)
-  -GRAY- (91000 TO 99000)

No. of Balls Adjustment

3 BALL 5 BALL

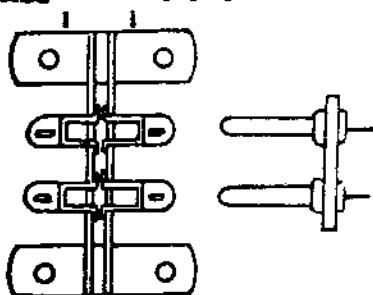

THIS JACK CHANGES 3 BALL TO 5 BALL PLAY OR VICE VERSA.

NUMBER MATCH ADJUSTMENT

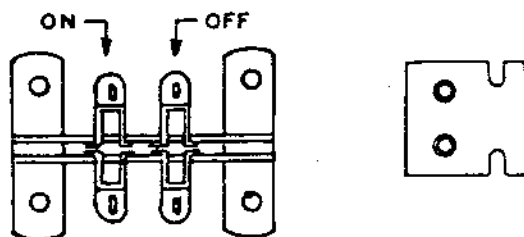

In 'ON' position, a number match lite will appear when game is over. To award replays, when number is matched, Extra Ball Adjustment Jack must be in 'Replay' position. In 'Off' position, Number Match is inoperative.

Extra Ball Jack Adj.

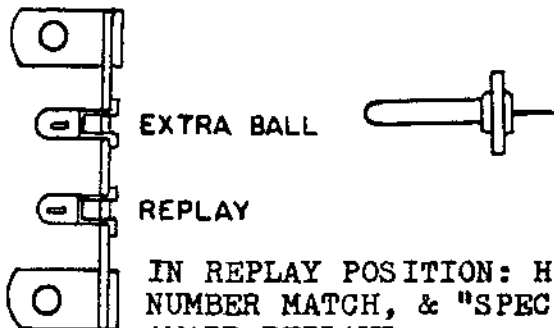

IN REPLAY POSITION: HI SCORES, NUMBER MATCH, & "SPECIAL" WILL AWARD REPLAYS.

IN EXTRA BALL POSITION: HI-SCORES OR "SPECIAL" WILL AWARD EXTRA BALLS.

CENTER TARGET ADJUSTMENT ON PLAYFIELD

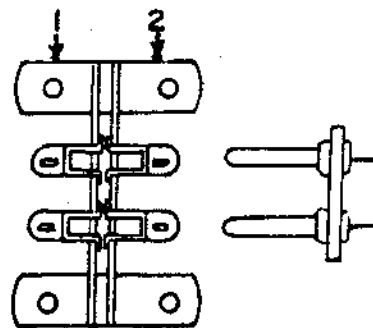

HITTING CENTER TARGET SWITCH, WHEN ALL A, B, C AND D RELAYS ARE TRIPPED, WILL ENERGIZE SPECIAL RELAY TO SCORE ONE OR TWO REPLAYS OR ONE EXTRA BALL.

ADJUSTMENTS ON MECHANISM PANEL

10¢ Adjustment

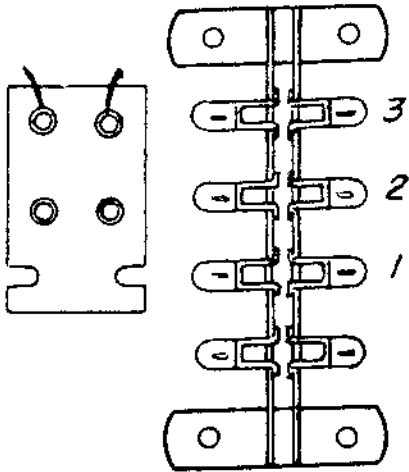

PROVIDES
1, 2 OR
3 PLAYS
FOR ONE
COIN.

5¢ Adjustment

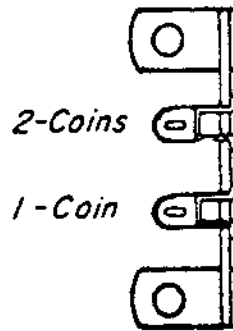

IN "2 COINS FOR
1 PLAY", CIRCUIT
TO COIN RELAY
PASSES THRU SW.
ON ALTERNATOR
UNIT.



25¢ Adjustment

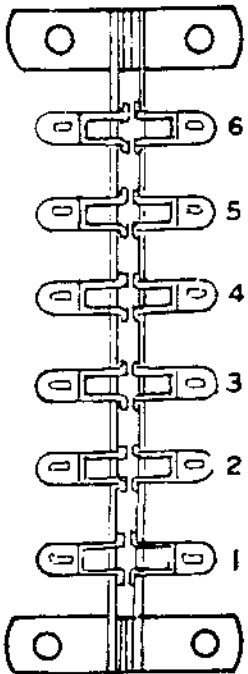

PROVIDES 1, 2, 3, 4, 5
OR 6 PLAYS FOR 25¢.

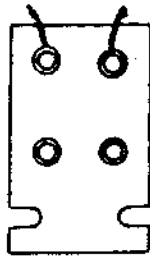

Motor Service Jack



ON



OFF



INSERT PHONE TIP IN
"OFF" POSITION - CAMS
CAN BE TURNED BY HAND
TO CHECK ADJUSTMENT OF
SWITCHES.

1 COIN- 1 PLAY
2 COINS- 3 PLAYS

SEE PAGE 1 FOR
EXPLANATION &
CIRCUITRY.

MASTER ON-OFF SW.

(Located under front of
Cabinet)

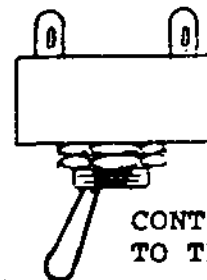

CONTROLS POWER
TO TRANSFORMER

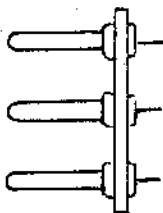
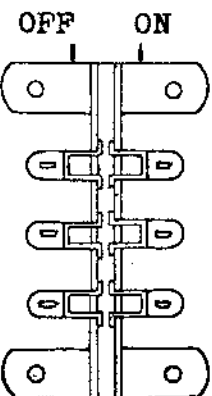

WARRANTY

THE MOTORS IN ALL NEW WILLIAMS PRODUCTS ARE UN-CONDITIONALLY GUARANTEED FOR 6 MONTHS FROM DATE OF PURCHASE.

ANY DEFECTIVE MOTORS RETURNED DURING THE WARRANTY PERIOD WILL BE REPLACED FREE OF CHARGE BY YOUR WILLIAMS DISTRIBUTOR.

IMPORTANT NOTICE

WHEN ORDERING PARTS ALWAYS SPECIFY NAME OF UNIT, GAME AND SERIAL NUMBER, IN ADDITION TO A CLEAR DESCRIPTION OF THE PART AND PART NUMBER IF POSSIBLE.

UNIT PARTS LIST

UNIT NAME	CONTACT DISC	WIPER ASSEMBLY	RATCHET GEAR ASSEMBLY	MOTORS
REPLAY	-----	-----	A-6400-1	
BALL COUNT	C-6414	B-7456-4	A-6402-5	
NO. MATCH	C-6417	C-6521	A-6403	
PLAYER	C-6417	C-6521	A-6404-3	
COIN	C-6414	B-7456-9	A-6402-3	
BONUS	C-6417	B-7456-33	A-6402-10	SCORE MOTOR
10 POINT	B-7253	A-6294	3C-7272	14A-7883 (60 CYCLE)
100 POINT	-----	-----	3C-7272	14A-7884 (50 CYCLE)
1000 POINT	B-7253	A-6294	3C-7272	
10000 POINT	B-7253	A-6294	3C-7272	
ALTERNATOR	-----	-----	3C-7272	

"STRATO FLITE" COIL CHART

NOTICE:

THIS GAME OPERATES ON 24 VOLTS. WHEN ORDERING REPLACEMENT TRANSFORMERS, MOTORS, COILS OR METERS ... MAKE SURE TO SPECIFY CORRECT PART NUMBER.

NUMBER	DESCRIPTION	LOCATION
14 A-7883	CONTROL MOTOR - 60 CYCLE	MECH. PANEL
14 A-7884	CONTROL MOTOR - 50 CYCLE	MECH. PANEL
15 A-6771	TRANSFORMER - 60 CYCLE	MECH. PANEL
15 A-6782-1	TRANSFORMER - 50 CYCLE	MECH. PANEL
B 6396	METER - 24 VOLT	MECH. PANEL
<u>SOLENOID COILS</u>		
A 22-550	COIN UNIT STEP UP BONUS UNIT STEP UP PLAYER UNIT STEP UP BALL RELEASE	MECH. PANEL PLAYFIELD INSERT PLAYFIELD
A 23-600	BALL COUNT UNIT STEP UP REPLAY UNIT STEP UP NUMBER MATCH UNIT STEP UP	MECH. PANEL INSERT INSERT
A 2-23-750	KNOCKER	CABINET
A 2-26-1300	CHIME COILS ... (3 req'd.)	CABINET
B 1-26-800	BALL COUNT UNIT RESET COIN UNIT RESET ALTERNATOR UNIT STEP UP PLAYER UNIT RESET REPLAY UNIT RESET SCORE DRUM UNITS ... (16 req'd.) BONUS UNIT RESET	MECH. PANEL MECH. PANEL MECH. PANEL INSERT INSERT INSERT PLAYFIELD
FL 20-300/ 28-400	FLIPPERS ... (2 req'd.)	PLAYFIELD
G 23-750 D.C.	JET BUMPER COILS ... (3 req'd.) AUTOMATIC KICKERS ... (2 req'd.)	PLAYFIELD PLAYFIELD
G 23-750	EJECT COIL	PLAYFIELD
M 29-900	1 - 2 RESET RELAY 3 - 4 RESET RELAY	INSERT INSERT
M 29-1000	GAME OVER RELAY TRIP RESET RELAY	MECH. PANEL MECH. PANEL
M 29-1100	10 PT. RELAY 100 PT. RELAY 1,000 PT. RELAY ADVANCE RELAY SPECIAL RELAY 50 PT. RELAY 5,000 PT. RELAY BONUS RELAY 5¢ RELAY 10¢ RELAY 25¢ RELAY	INSERT INSERT INSERT PLAYFIELD PLAYFIELD PLAYFIELD PLAYFIELD PLAYFIELD MECH. PANEL MECH. PANEL MECH. PANEL
M 1-31-1500	COIN LOCKOUT COIL	FRONT DOOR
XM 27-675	TOTAL PLAY METER COIL	MECH. PANEL
Z 27-1000	GAME OVER RELAY LATCH PLAYER RESET RELAY REPLAY RELAY COIN RELAY OUTHOLE RELAY EJECT RELAY	MECH. PANEL MECH. PANEL MECH. PANEL MECH. PANEL MECH. PANEL MECH. PANEL
Z 28-1150	TILT RELAY BALL INDEX RELAY EXTRA BALL RELAY	MECH. PANEL MECH. PANEL MECH. PANEL
Z 29-1250	LOCK RELAY	MECH. PANEL
D 1-22-1150	BANK RESET COIL	PLAYFIELD
S 27-500	BANK TRIP COIL (15 req'd.)	PLAYFIELD
Z 28-1200	BOTTOM GATE RELAY TOP GATE RELAY	PLAYFIELD PLAYFIELD
M 30-1300	COIN SET UP RELAY	MECH. PANEL

IMPORTANT NOTICE

KINDLY INFORM LOCATIONS THAT THEY CAN TURN DISPLAY LIGHTS ON BY PRESSING LEFT FLIPPER BUTTON. MACHINE CAN STILL BE SHUT OFF BY TAPPING BOTTOM OF CABINET.

MASTER SWITCH (ON-OFF) IS LOCATED UNDERNEATH FRONT PART OF CABINET.

CAUTION!

The playboard on this machine has an improved finish with excellent wearing properties. Do not under any circumstances clean the board with water, water soap solutions or harsh abrasives. Avoid such things as steel wool, kitchen cleansers or abrasive hand soap. Water will weaken the adhering of the paint to the board and abrasives shorten the board life by many thousand plays. A wax base cleaner with negligible abrasive qualities used lightly, but frequently, will extend the board life to its full capabilities.

SERVICEMAN TO REMOVE BACKGLASS:

- WITH BACK DOOR REMOVED, PULL BACK ON BRACKETS AT INSIDE TOP OF LITE BOX.
- FROM THE FRONT OF GAME, LIFT GLASS UP AND OUT.

"STRATO-FLITE"-POST ADJUSTMENT SHEET

TO MAKE GAME MORE CONSERVATIVE OR LIBERAL MOVE POST 3/16 AS SHOWN IN SKETCH BELOW SPOTTING HOLES ARE PROVIDED AND CAN BE SEEN ON REMOVAL OF POSTS.

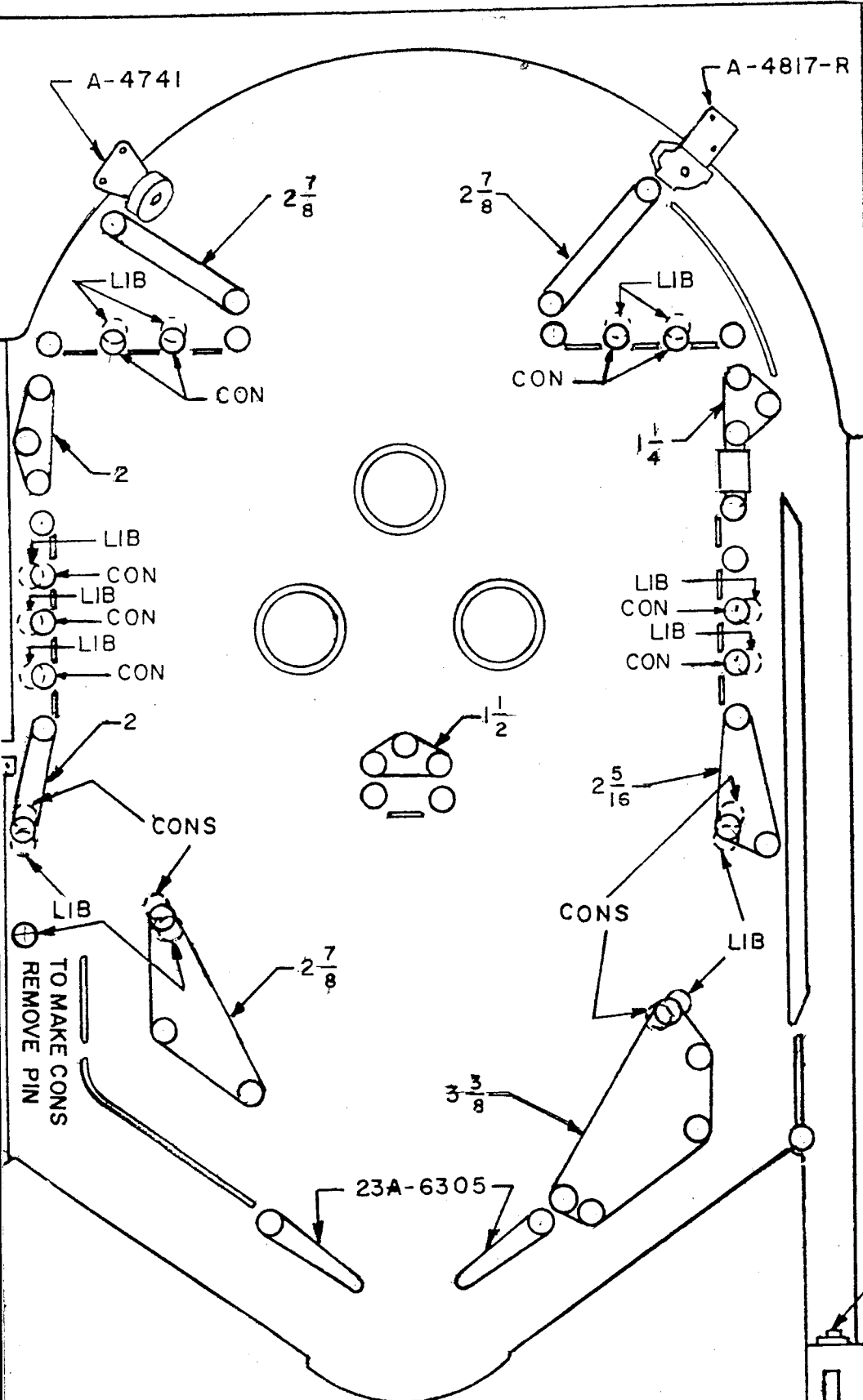

ABBREVIATIONS:
 CONS - CONSERVATIVE
 LIB - LIBERAL

RUBBER RING NUMBERS

23A-6300	5/16" I.D.
23A-6303	1 1/4 I.D.
23A-6304	1 1/2 I.D.
23A-6305	2" I.D.
23A-6306	2 5/16 I.D.
23A-6307	2 7/8 I.D.
23A-6308	3 3/8 I.D.
23A-6309	3 7/8 I.D.

A-4741 REBOUND ASS'Y
 A-4817-R BALL GATE ASS'Y

23A-6327 BALL SHOOTER
 RUBBER TIP

DIMENSIONS INDICATED BY ARROWS ARE FOR SIZES
 10 OF RUBBER RINGS.

JACK LAYOUT

GAME STRATO - FLITE

POSITION PAN - P.F. SIZE 22

	<u>B-</u>	<u>G/W-3 BONUS RE.</u>
1	<u>FEED</u>	<u>B/</u>
2	<u>"</u>	<u>BLU-1 OUTHOLE RE.</u>
3	<u>"</u>	<u>W/R-1</u>
4	<u>EX-BALL RE.</u>	<u>BLU</u>
5	<u>SHOOT AGAIN</u>	<u>W-4 BALL RELEASE</u>
6	<u>LITE</u>	<u>Y/R-2 TILT RE.</u>
7	<u>BONUS PRESET</u>	<u>Y-</u>
8	<u>"</u>	<u>W-4 R.P.S.U.</u>
9	<u>"</u>	<u>W-</u>
10	<u>BONUS S.U.</u>	<u>Y/BR-5 BONUS S.U.</u>
11	<u>FEED</u>	<u>BLU</u>
	<u>BLU.</u>	<u>Y/W-1 FEED</u>
		<u>Y/BLU-3 TOP GATE RE.</u>

JACK LAYOUT

GAME STRATO - FLITE

POSITION PAN - P.F. SIZE 18

	<u>BR-10</u>	<u>G/O-3 EJECT RE.</u>
1	<u>BANK RESET</u>	<u>GAY</u>
2	<u>"</u>	<u>O-4</u>
3	<u>1000 PT. RE.</u>	<u>O/G</u>
4	<u>"</u>	<u>BR</u>
5	<u>"</u>	<u>W-5 X-FILIPPIAN</u>
6	<u>"</u>	<u>BR</u>
7	<u>"</u>	<u>W-5 R-</u>
8	<u>"</u>	<u>R/O-3 R.P.S.U.</u>
9	<u>"</u>	<u>R/BR. 50-PT. RE.</u>
	<u>R.P.</u>	<u>R/</u>
	<u>CONTRAL RE.</u>	<u>BLU-4 EJECT COIL</u>
	<u>PRESET RE.</u>	<u>W/</u>
		<u>BR-4 TOP GATE RE.</u>

JACK LAYOUT

GAME STRATO - FLITE

POSITION PAN - INS. SIZE 24

1	FEED	BR-1	Y-1	BALL COUNT S.U.	GRY Y-1
2	"	BR-1	G-1	"	1ST. PLAYER BRU-2
3	COIN	BR-4	BR	PLAYER S.U.	2ND. PLAYER BR
4	LOCKOUT	BR-4	BR	PLAYER S.U.	3RD. PLAYER BR
5	REPLAY RE.	W/O	Y	PLAYER RESET	4TH. PLAYER BR
6	"	W/BR-1	BR-5	EX-BALL RE.	MATCH Y-5
7	"	W/BR-1	B/O-1	RESET RE.	GRY BR-2
8	KNOCKER	BR/W	GRY	BR-5	LARGE CHIME G-3
9	RESET RE.	BRU-1	Y-	FEED	TILT LITE BRU-2
10	BALL COUNT S.U.	BRU-1	W/G-4	SHOOT AGAIN LITE	BALL IND. RE. BR
11	No. 1	BR-1	BR	NO. 2	BR Y
12	BALL LITE	BR-5	Y-6	BALL LITE	BR P.P. RESET
	FEED	BR.	BR/BLU.	RESET RE.	
	BLANK			BLANK	

JACK LAYOUT

GAME STRATO - FLITE

POSITION PAN - INS. SIZE 20

1	GRY W-3	1-CAN PLAY LITE
2	Y/G-1	2-11
3	W/O	3-11
4	O/R-3	4-11
5	R/W	BALL COUNT S.U.
6	BLU/R-4	G-O-RE.
7	Y-U	" 4
8	BLU/R-4	" 11
9	GRY/G-2	NO. 4 BALL LITE
10	GRY/BR-2	NO. 5 BALL LITE

BALL COUNT UNIT DISC

THIS UNIT RESETS AT THE START OF A NEW GAME, (DURING RESET CYCLE). IT ADVANCES ONE STEP EACH TIME THE LAST PLAYER COMPLETES HIS TURN.

View looking at WIPER FINGER side with WIPER in ZERO position.

DIAGRAM LOCATION
↓

TRIPS GAME OVER RELAY IN 5 BALL GAME.

TRIPS GAME OVER RELAY IN 3 BALL GAME.

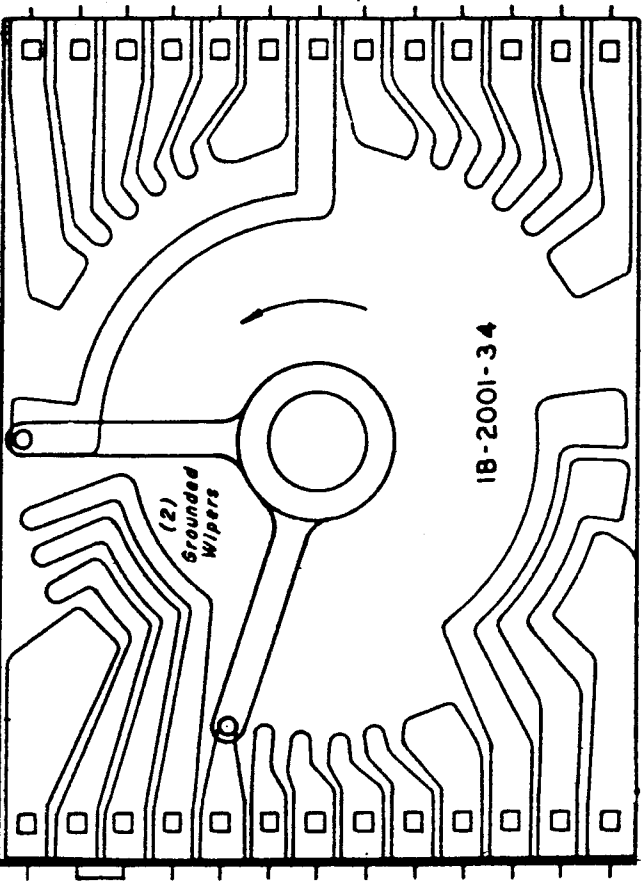
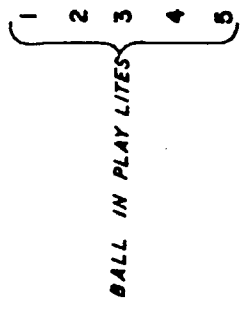

COIN S. U. DISC

THIS UNIT RESETS AT START OF A GAME (DURING RESET CYCLE). IT THEN ADVANCES ONE STEP EACH TIME THE COIN RELAY IS PULSED.

View looking at WIPER FINGER side with WIPER in RESET position

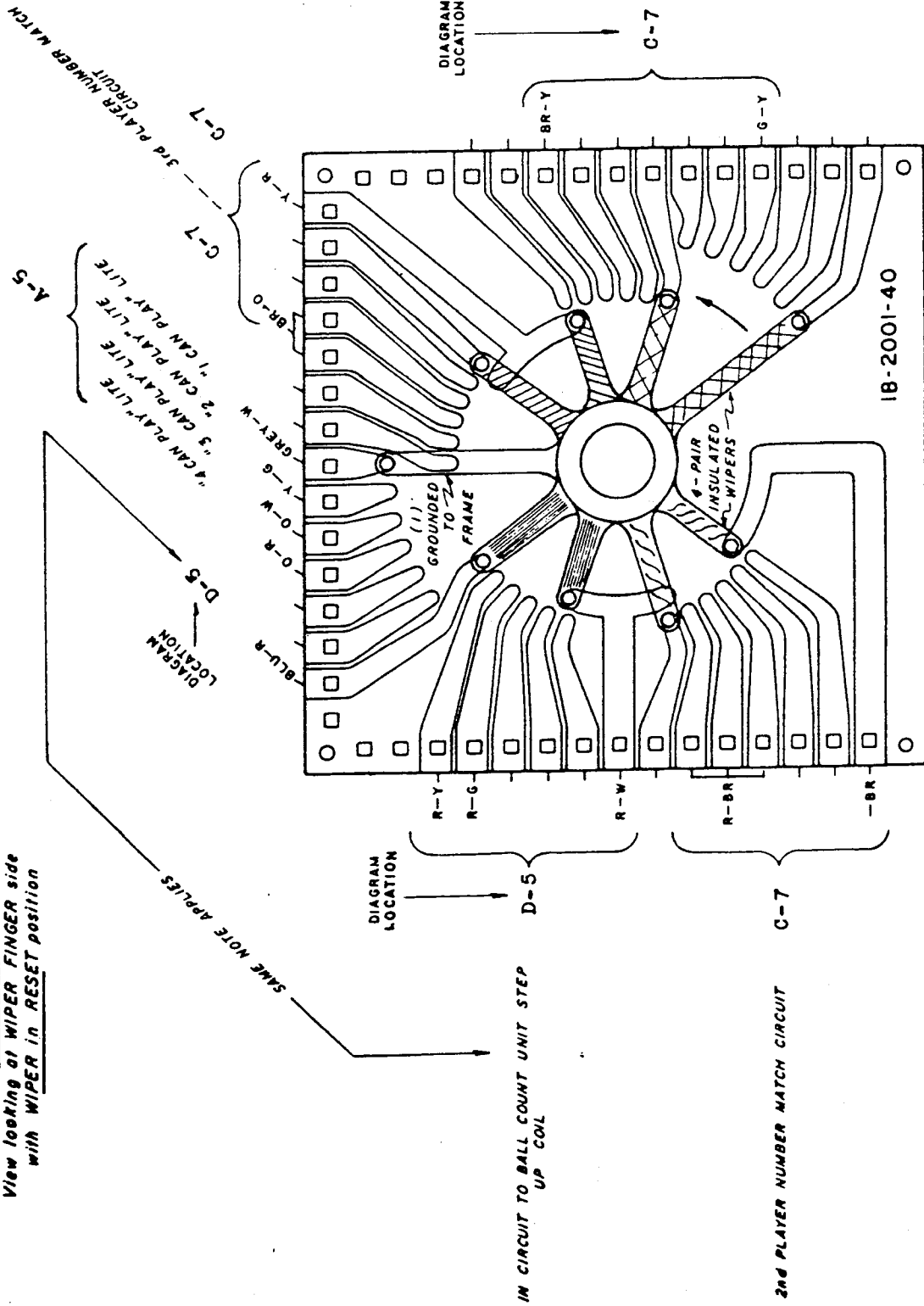

IN CIRCUIT TO BALL COUNT UNIT STEP UP COIL

2nd PLAYER NUMBER MATCH CIRCUIT

4th PLAYER NUMBER MATCH CIRCUIT

PLAYER UNIT DISC

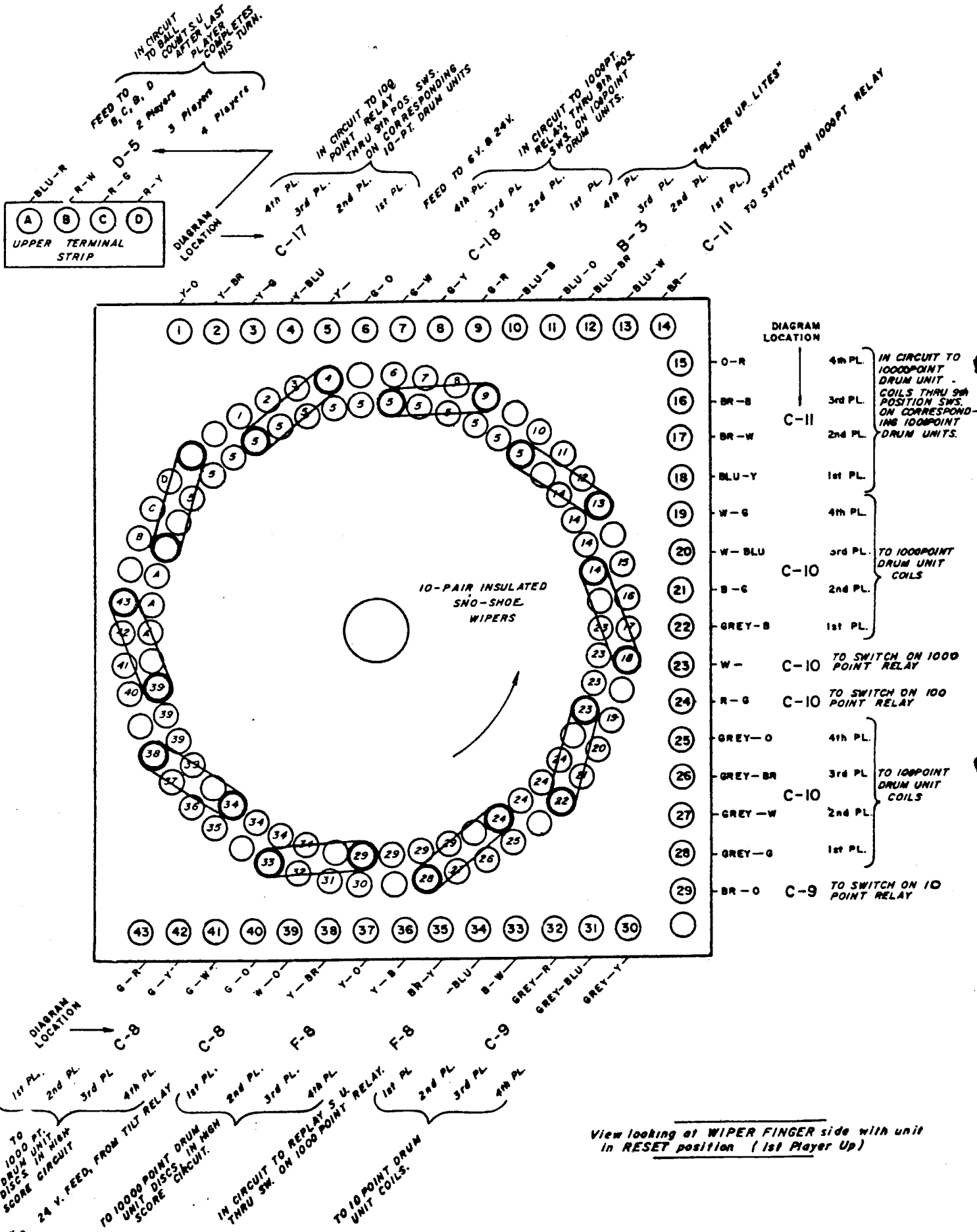

View looking at WIPER FINGER side with unit in RESET position (1st Player Up)

BONUS UNIT

THIS UNIT STEPS UP EACH TIME THE ADVANCE RELAY OR EJECT RELAY IS ENERGIZED.

ALSO, AFTER THIS UNIT HAS BEEN RESET TO ZERO, THE STEP-UP COIL IS ENERGIZED ONCE BY SCORE MOTOR CAM SWITCH 6A, THRU BONUS UNIT WIPER FINGERS. THE RESET COIL IS ENERGIZED BY BONUS RELAY, THRU DOUBLE BONUS RELAY AND SCORE MOTOR CAM SWITCH 4C OR IMPULSE CAM SWITCH A.

A-9	1000	R-Y
	2000	R-G
	3000	R-W
	4000	R-BR
	5000	R-O
	6000	R-B
	7000	-BLU
	8000	BLU-R
	9000	O-W
A-10	10,000	BLU-B
		BLU-BR
		Y-BR
		B-BLU
D-12		
D-13		

TO BONUS UNIT S.U. COIL THRU CAM SWITCH 6A.

PULSES OUTHOLE RELAY AT CAM SWITCH 6B.

D-13 SEE #1 (B-BLU)

VIEW LOOKING AT WIPER FINGER SIDE, WITH WIPER IN ZERO POSITION.

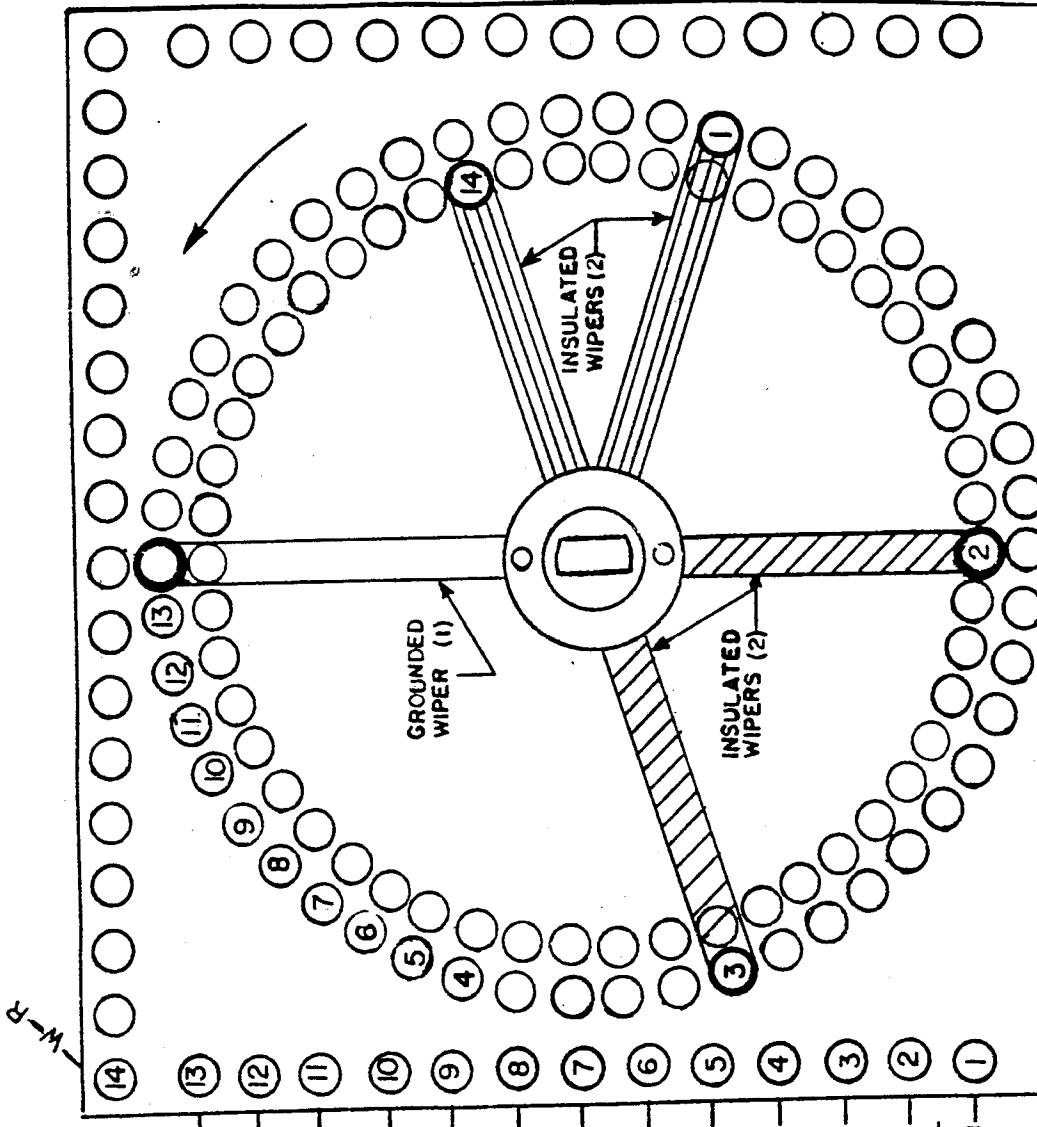

PLAYER UNIT DISC

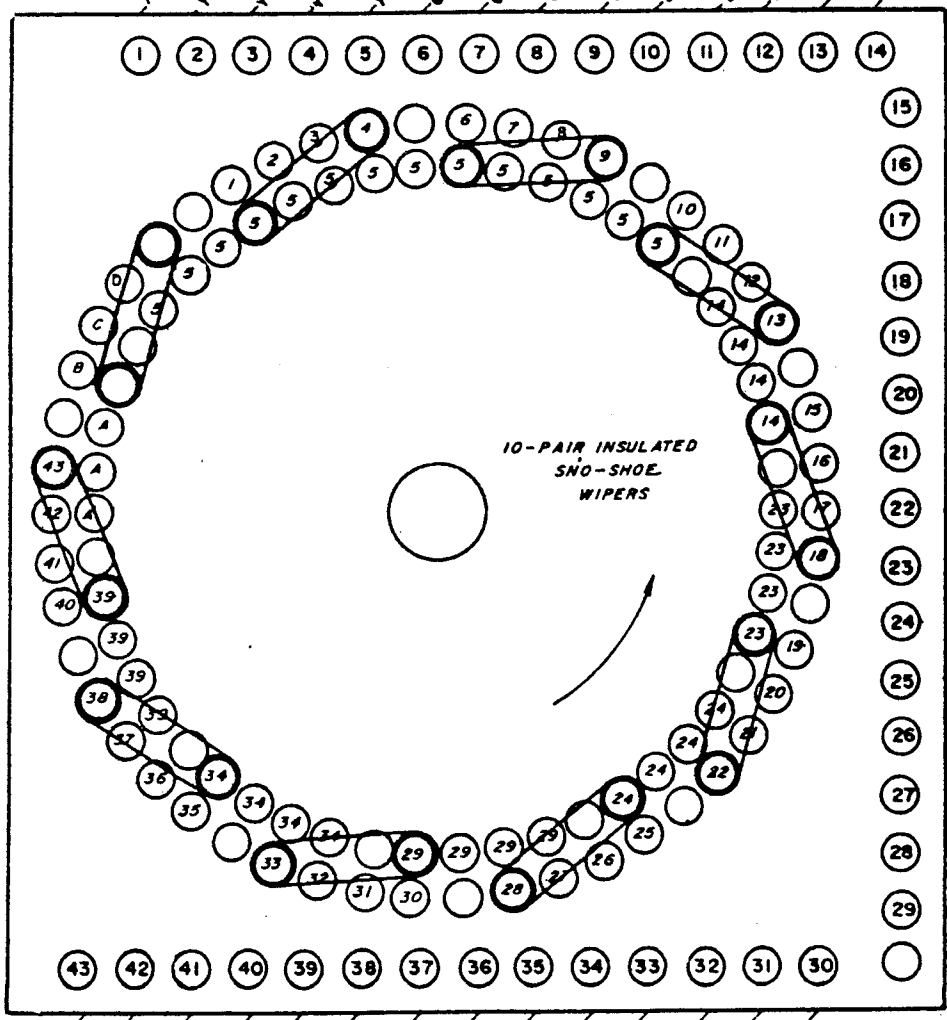
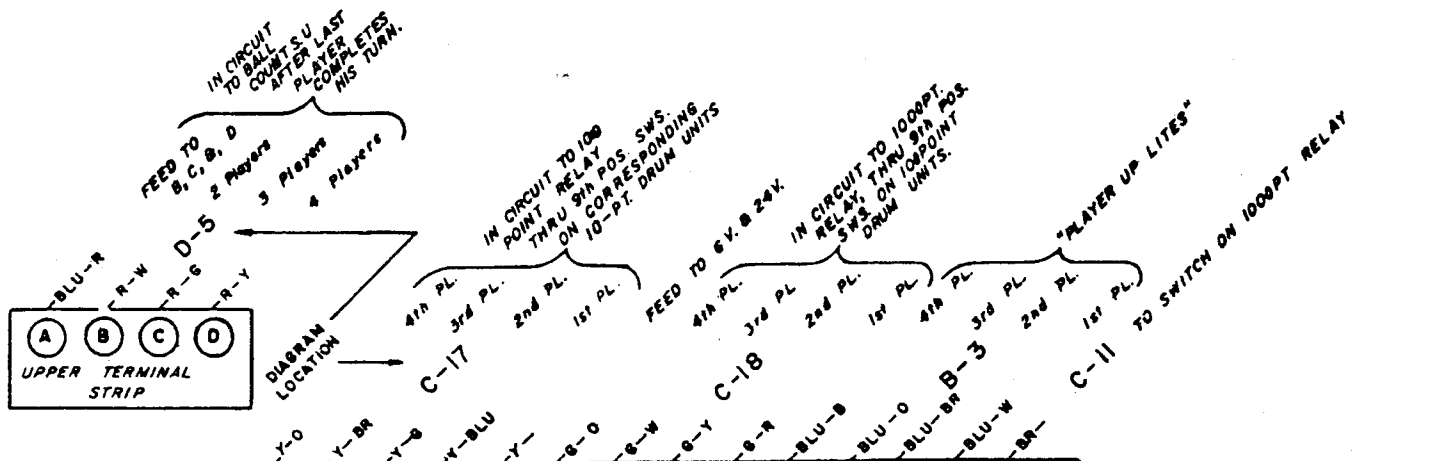
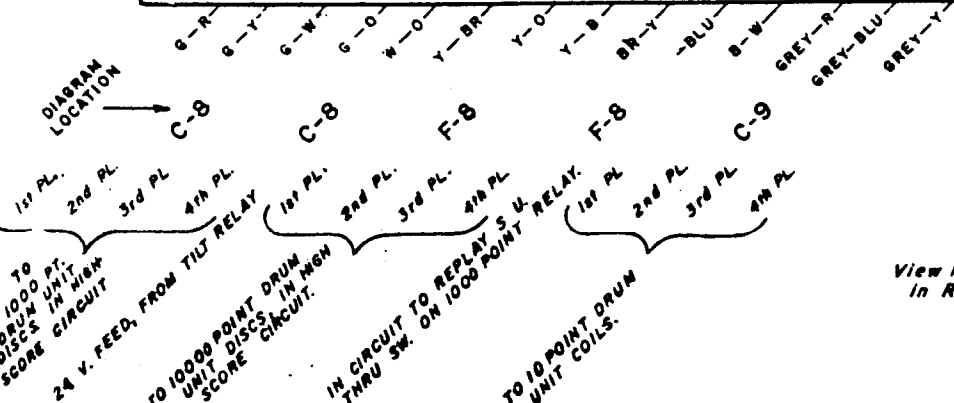

DIAGRAM LOCATION	PL.	Notes
O-R	4th PL.	IN CIRCUIT TO 1000POINT DRUM UNIT - COILS THRU 9th POSITION SWS. ON CORRESPONDING 1000POINT DRUM UNITS.
BR-B	3rd PL.	
BR-W	2nd PL.	
BLU-Y	1st PL.	
W-G	4th PL.	TO 1000POINT DRUM UNIT COILS
W-BLU	3rd PL.	
B-G	2nd PL.	
GREY-B	1st PL.	
W-	C-10	TO SWITCH ON 1000 POINT RELAY
R-G	C-10	TO SWITCH ON 100 POINT RELAY
GREY-O	4th PL.	TO 1000POINT DRUM UNIT COILS
GREY-BR	3rd PL.	
GREY-W	2nd PL.	
GREY-G	1st PL.	
BR-O	C-9	TO SWITCH ON 100 POINT RELAY



View looking at WIPER FINGER side with unit in RESET position (1st Player Up)

RELAY	SW.	WIRE COLORS	DIAG. LOC.	TYPE	SWITCH OPERATION
1-A RELAY	1D	GRAY-G -J-	C-20	N.O.	IN SERIES WITH SWITCH 3D ON 2-A RELAY.
	1C	-J- -Y-	C-19	N.O.	IN SERIES WITH SWITCH 3C ON 2-A RELAY.
	1B	-Y- -J-	C-20	N.O.	IN SERIES WITH SWITCH 3B ON 2-A RELAY.
	1A	O-R -W-	A-6	N.O.	TO 1-A TARGET LITE. ALSO IN SERIES WITH SW. 3A ON 2-A RELAY.
	2C	-J- R-BLU Y-B	E-15	M&B	OPENS TO COIL ON THIS RELAY AND CLOSES TO 50 POINT RELAY (WHEN BALL HITS 1-A TARGET SWITCH).
	2B	-J- -J-	D-20	N.O.	IN SERIES WITH SWITCH 4B ON 2-A RELAY.
	2A	-J- B-G	B-7	N.O.	TO "SPECIAL" TARGET LITE. CIRCUIT ORIGINATES AT SWITCH 23A ON 3-D RELAY.
2-A RELAY	3D	-J- -J-	C-20	N.O.	IN SERIES WITH SWITCH 5D ON 3-A RELAY.
	3C	-J- -J-	D-19	N.O.	IN SERIES WITH SWITCH 5C ON 3-A RELAY.
	3B	-J- -J-	C-20	N.O.	IN SERIES WITH SWITCH 5B ON 3-A RELAY.
	3A	O-R -J-	A-6	N.O.	IN SERIES WITH SWITCH 5A ON 3-A RELAY.
	4D	-J- R-W Y-B	E-15	M&B	OPENS TO COIL ON THIS RELAY AND CLOSES TO 50 POINT RELAY. (WHEN BALL HITS 2-A TARGET SW.).
	4C	GRAY-B -W-	A-7	N.O.	TO 2-A TARGET LITE.
	4B	-J- -J-	D-20	N.O.	IN SERIES WITH SWITCH 6B ON 3-A RELAY.
3-A RELAY	4A	-J- -J-	B-7	N.O.	IN SERIES WITH SWITCH 2A ON 1-A RELAY.
	5L	-J- -J-	C-20	N.O.	IN SERIES WITH SWITCH 7D ON 1-B RELAY.

RELAY	SW.	WIRE COLORS	DIAG. LOC.	TYPE	SWITCH OPERATION
3-A RELAY	5C	-J- -J-	D-19	N.O.	IN CIRCUIT TO DOUBLE BONUS RELAY. (SEE SWITCH 1C ON 1-A RELAY).
	5B	-J- -J-	C-20	N.O.	IN SERIES WITH SWITCH 7B ON 1-B RELAY AND SWITCH 19.B ON 1-D RELAY.
	5A	-O- -J-	B-6	N.O.	TO "A" STAR LITE.
	6D	-J- R-O Y-B	E-15	M&B	OPENS TO COIL ON THIS RELAY AND CLOSSES TO 50 POINT RELAY. (WHEN BALL HITS 3-A TARGET SW.).
	6C	GRAY-O -W-	A-7	N.O.	TO 3-A TARGET LITE.
	6B	-J- -J-	E-20	N.O.	IN SERIES WITH SWITCH 30B ON TRIPLE BONUS RELAY.
	6A	-J- -J-	A-7	N.O.	IN SERIES WITH SWITCH 4A ON 2-A RELAY.
1-B RELAY	7D	-J- -J-	D-20	N.O.	IN SERIES WITH SWITCH 9D ON 2-B RELAY.
	7C	-J- -Y-	C-19	N.O.	IN SERIES WITH SWITCH 9C ON 2-B RELAY.
	7B	-J- -J-	D-20	N.O.	IN SERIES WITH SWITCH 9B ON 2-B RELAY.
	7A	-W- O-G	A-6	N.O.	TO 1-B TARGET LITE. ALSO IN SERIES WITH SW. 9A ON 2-B RELAY.
	8C	-J- R-B W-R	E-15	M&B	OPENS TO COIL ON THIS RELAY AND CLOSSES TO 100 POINT RELAY. (WHEN BALL HITS 1-B TARGET SW.).
	8B	-Y- -J-	C-20	N.O.	IN SERIES WITH SWITCH 10B ON 2-B RELAY.
	8A	-J- -J-	A-7	N.O.	IN SERIES WITH SWITCH 6A ON 3-A RELAY.
2-B RELAY	9D	-J- -J-	D-20	N.O.	IN SERIES WITH SWITCH 11D ON 3-B RELAY.
	9C	-J- -J-	D-19	N.O.	IN SERIES WITH SWITCH 11C ON 3-B RELAY.
	9B	-J- -J-	D-20	N.O.	IN SERIES WITH SWITCH 11B ON 3-B RELAY.

RELAY	SW.	WIRE COLORS	DIAG. LOC.	TYPE	SWITCH OPERATION
2-B RELAY	9A	-J- O-G	A-6	N.O.	IN SERIES WITH SWITCH 11A ON 3-B RELAY.
	10D	-J- BLU-R W-R	E-15	M&B	OPENS TO COIL ON THIS RELAY AND CLOSSES TO 100 POINT RELAY. (WHEN BALL HITS 2-B TARGET SW.).
	10C	R-Y -W-	A-7	N.O.	TO 2-B TARGET LITE.
	10B	-J- -J-	C-20	N.O.	IN SERIES WITH SWITCH 12B ON 3-B RELAY.
	10A	-J- -J-	A-7	N.O.	IN SERIES WITH SWITCH 8A ON 1-B RELAY.
3-B RELAY	11D	-J- -J-	D-20	N.O.	IN SERIES WITH SWITCH 13 D ON 1-C RELAY.
	11C	-J- -J-	D-19	N.O.	IN CIRCUIT TO DOUBLE BONUS RELAY. (SEE SWITCH 7C ON 1-B RELAY).
	11B	-J- -J-	E-20	N.O.	IN SERIES WITH SWITCH 30B ON TRIPLE BONUS RELAY.
	11A	-J- O-BLU	B-6	N.O.	TO "B" STAR LITE.
	12D	-J- BLU-Y W-R	E-15	M&B	OPENS TO COIL ON THIS RELAY AND CLOSSES TO 100 POINT RELAY. (WHEN BALL HITS 3-B TARGET SW.).
	12C	G-W -W-	A-7	N.O.	TO 3-B TARGET LITE.
	12B	-J- -J-	C-20	N.O.	IN SERIES WITH SWITCH 13B ON 1C RELAY AND 20B ON 1-D RELAY.
	12A	-J- -J-	A-7	N.O.	IN SERIES WITH SWITCH 10A ON 2-B RELAY.
1-C RELAY	13D	-J- -J-	D-20	N.O.	IN SERIES WITH SWITCH 15D ON 2-C RELAY.
	13C	-J- -Y-	C-19	N.O.	IN SERIES WITH SWITCH 15C ON 2-C RELAY.
	13B	-J- -J-	D-20	N.O.	IN SERIES WITH SWITCH 15B ON 2-C RELAY.

RELAY	SW.	WIRE COLORS	DIAG. LOC.	TYPE	SWITCH OPERATION
1-C RELAY	13A	-W- O-B	A-6	N.O.	TO 1-C TARGET LITE. ALSO IN SERIES WITH SWITCH 15A ON 2-C RELAY.
	14C	-J- BLU-O W-R	E-16	M&B	OPEN TO COIL ON THIS RELAY AND CLOSES TO 100 POINT RELAY. (WHEN BALL HITS 1-C TARGET SW.).
	14B	-Y- -J-	C-20	N.O.	IN SERIES WITH SWITCH 16B ON 2-C RELAY.
	14A	-J- -J-	A-7	N.O.	IN SERIES WITH SWITCH 12A ON 3-B RELAY.
2-C	15D	-J- -J-	D-20	N.O.	IN SERIES WITH SWITCH 17D ON 3-C RELAY.
	15C	-J- -J-	D-19	N.O.	IN SERIES WITH SWITCH 17C ON 3-C RELAY.
	15B	-J- -J-	D-20	N.O.	IN SERIES WITH SWITCH 17B ON 3-C RELAY.
	15A	-J- O-B	A-6	N.O.	IN SERIES WITH SWITCH 17A ON 3-C RELAY.
	16D	-J- BLU-B W-R	E-16	N.O.	OPENS TO COIL ON THIS RELAY AND CLOSES TO 100 POINT RELAY. (WHEN BALL HITS 2-C TARGET SW.).
	16C	W-O -W-	A-7	N.O.	TO 2-C TARGET LITE.
	16B	-J- -J-	C-20	N.O.	IN SERIES WITH SWITCH 18B ON 3-C RELAY.
	16A	-J- -J-	A-7	N.O.	IN SERIES WITH SWITCH 14A ON 1-C RELAY.
3-C RELAY	17D	-J- -J-	D-20	N.O.	IN SERIES WITH SWITCH 19D ON 1-D RELAY.
	17C	-J- -J-	D-19	N.O.	IN CIRCUIT TO DOUBLE BONUS RELAY. (SEE SWITCH 13C ON 1-C RELAY).
	17B	-J- -J-	E-20	N.O.	IN SERIES WITH SWITCH 30P ON TRIPLE BONUS RELAY.
	17A	-J- O-W	B-6	N.O.	TO "C" STAR LITE.

RELAY	SW.	WIRE COLORS	DIAG. LOC.	TYPE	SWITCH OPERATION
3-C RELAY	18D	-J- Y-R W-R	E-16	M&B	OPENS TO COIL ON THIS RELAY AND CLOSES TO 100 POINT RELAY. (WHEN BALL HITS 3-C TARGET SW.).
	18C	O-G -W-	A-7	N.O.	TO 3-C TARGET LITE.
	18B	-J- -J-	C-20	N.O.	IN SERIES WITH SWITCH 2B ON 1-A RELAY AND 20A ON 1-D RELAY.
	18A	-J- -J-	B-7	N.O.	IN SERIES WITH SWITCH 16A ON 2-C RELAY.
1-D RELAY	19D	-J- -J-	E-20	N.O.	IN SERIES WITH SWITCH 21D ON 2-D RELAY.
	19C	-J- -Y-	C-19	N.O.	IN SERIES WITH SWITCH 21C ON 2-D RELAY.
	19B	-J- -J-	D-20	N.O.	IN SERIES WITH SWITCH 21B-ON 2-D RELAY.
	19A	-J- B-R	B-7	N.O.	TO "D" STAR LITE. ALSO IN SERIES WITH SWITCH 25B ON REPLAY CONTROL RELAY.
	20D	-J- Y-BLU Y-B	E-16	M&B	OPENS TO COIL ON THIS RELAY AND CLOSES TO 50 POINT RELAY. (WHEN BALL HITS 1-D TARGET SW.).
	20C	B-BLU -W-	A-8	N.O.	TO 1-D TARGET LITE.
	20B	-J- -J-	D-20	N.O.	IN SERIES WITH SWITCH 22B ON 2-D RELAY.
	20A	-J- -J-	D-20	N.O.	IN SERIES WITH SWITCH 22A ON 2-D RELAY.
2-D RELAY	21D	-J- -J-	E-20	N.O.	IN SERIES WITH SWITCH 23D ON 3-D RELAY.
	21C	-J- -J-	D-19	N.O.	IN SERIES WITH SWITCH 23C ON 3-D RELAY.
	21B	-J- -J-	D-20	N.O.	IN SERIES WITH SWITCH 23B ON 3-D RELAY.
	21A	-J- B-Y	A-7	N.O.	IN SERIES WITH SWITCH 19A ON 1-D RELAY.

RELAY	SW.	WIRE COLORS	DIAG. LOC.	TYPE	SWITCH OPERATION
2-D RELAY	22D	-J- Y-G Y-B	E-16	M&B	OPENS TO COIL ON THIS RELAY AND CLOSES TO 50 POINT RELAY. (WHEN BALL HITS 2-D TARGET SW.).
	22C	B-W -W-	A-8	N.O.	TO 2-D TARGET LITE.
	22B	-J- -J-	D-20	N.O.	IN SERIES WITH SWITCH 24B ON 3-D RELAY.
	22A	-J- -J-	D-20	N.O.	IN SERIES WITH SWITCH 24A ON 3-D RELAY.
3-D RELAY	23D	-J- -J-	E-20	N.O.	IN SERIES WITH SWITCH 25A ON REPLAY CONTROL RELAY.
	23C	-J- -J-	D-19	N.O.	IN CIRCUIT TO DOUBLE BONUS RELAY. (SEE SWITCH 19C ON 1-D RELAY.)
	23B	-J- -J-	E-20	N.O.	IN SERIES WITH SWITCH 30B ON TRIPLE BONUS RELAY.
	23A	-W- B-Y	A-7	N.O.	TO 3-D TARGET LITE. ALSO IN SERIES WITH 21A ON 2-D RELAY.
	24C	-J- Y-O Y-B	E-16	M&B	OPENS TO COIL ON THIS RELAY AND CLOSES TO 50 POINT RELAY. (WHEN BALL HITS 3-D TARGET SW.).
	24B	-J- -J-	E-20	N.O.	IN SERIES WITH SWITCH 30B ON TRIPLE BONUS RELAY.
	24A	-J- -J-	E-20	N.O.	IN SERIES WITH SWITCH 30B ON TRIPLE BONUS RELAY.
REPLAY CONTROL RELAY	25B	-J- B-R	B-7	N.C.	IN SERIES WITH SWITCH 18A ON 3-C RELAY.
	25A	B-R -J-	E-20	N.C.	TO SPECIAL RELAY COIL. CIRCUIT ORIGINATES AT SWITCH 1D ON 1-A RELAY.
DOUBLE BONUS RELAY	27B	R-B BLU-R R-BLU	D-12	M&B	IN CIRCUIT TO BONUS UNIT RESET COIL.
	27A	O-R -J-	B-8	N.O.	TO "DOUBLE BONUS" LITE, THRU SW. ON TRIPLE BONUS RELAY.
	28B	-O- O-B O-BLU	D-19	M&B	IN CIRCUIT TO 1,000 POINT RELAY (WHEN COLLECTING BONUS).

RELAY	SW.	WIRE COLORS	DIAG. LOC.	TYPE	SWITCH OPERATION
DOUBLE BONUS RELAY	28A	-J- -J-	E-19	N.C.	TO COIL ON THIS RELAY. (4 DIFFERENT CIRCUITS TO THIS SWITCH ORIGINATE AT SWITCHES 1C, 7C, 13C AND 19C).
TRIPLE BONUS RELAY	29A	Y-B GRAY-BR	E-14	N.O.	ENERGIZES EXTRA BALL RELAY, THRU LEFT BOTTOM (INSIDE) ROLLOVER SW.
	30C	-J- -W- B-Y	A-8	M&B	OPENS IN SERIES WITH SWITCH 27A ON DOUBLE BONUS RELAY AND CLOSSES TO "TRIPLE BONUS" LITE AND "EXTRA BALL WHEN LIT" LITE.
	30B	-J- -J-	E-20	N.C.	TO COIL ON THIS RELAY. (6 DIFFERENT CIRCUITS TO THIS SWITCH ORIGINATE AT 1B, 8B AND 14B).
	30A	O-W O-BLU	D-19	N.O.	IN CIRCUIT TO 1,000 POINT RELAY (WHEN COLLECTING BONUS).

RELAYS & SWITCHES

LOCATED ON MECHANISM PANEL

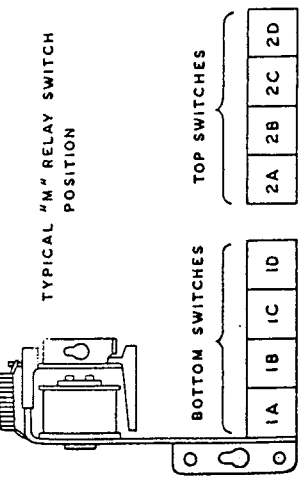

LOCK

IS ENERGIZED BY 5/4 RELAY, LEFT FLIPPER SWITCH OR SCORE MOTOR CAM SWITCH 5A.

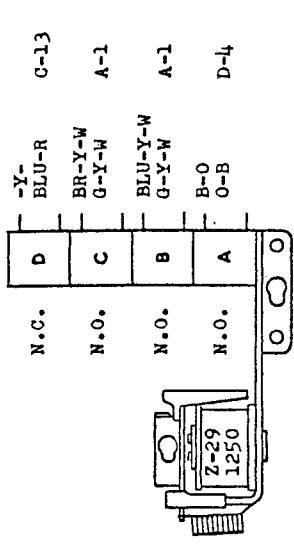

ENERGIZES GAME-OVER RELAY (TRIP COIL).
6 VOLTS FROM TRANSFORMER TO LITES.
6 VOLTS FROM TRANSFORMER TO LITES.
HOLD CIRCUIT TO THIS RELAY, THRU CABINET BOTTOM KICK-OFF SWITCH.

OUTHOLE

IS ENERGIZED BY SCORE MOTOR CAM SWITCH 6B, THRU BONUS UNIT DISC (IN ZERO POSITION).

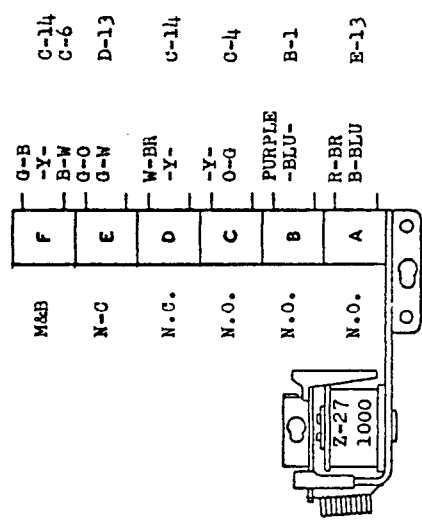

OPENS IN HOLD CIRCUIT TO BALL INDEX RELAY AND CLOSSES IN SERIES WITH SWITCH C ON EXTRA BALL RELAY.
IN CIRCUIT TO BONUS RELAY.
IN CIRCUIT TO TILT RELAY.
RUNS SCORE MOTOR.
ENERGIZES 115 VOLT RELAY BANK RESET COIL, THRU CAM SWITCH 3A.
IN HOLD CIRCUIT TO THIS RELAY.

PLAYER RESET

IS ENERGIZED BY BALL COUNT UNIT END-OF-STROKE SWITCH. IT THEN HOLDS IN THRU SCORE MOTOR INDEX CAM SWITCH D.

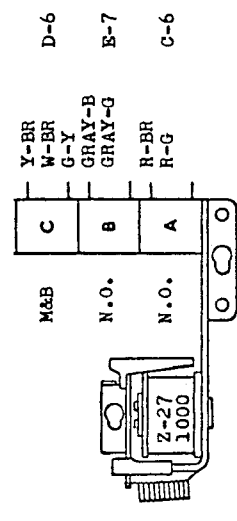

OPENS IN CIRCUIT TO PLAYER UNIT S.U. COIL AND CLOSSES TO PLAYER UNIT RESET COIL.
IN NUMBER MATCH CIRCUIT TO REPLAY S.U. COIL.
IN HOLD CIRCUIT TO THIS RELAY.

RESET

IS ENERGIZED BY COIN RELAY, THRU SWITCH ON GAME-OVER RELAY.

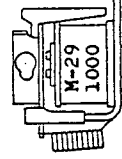
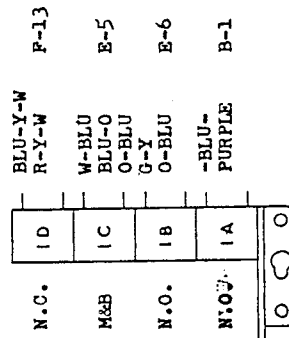
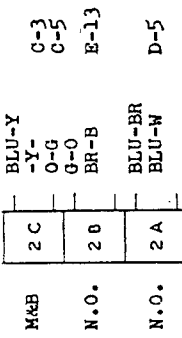

REPLAY

IS ENERGIZED BY REPLAY BUTTON, THRU ZERO SWITCH ON REPLAY UNIT.

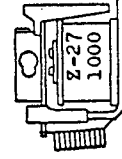
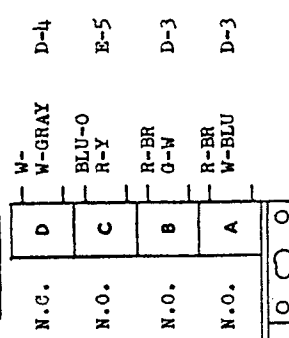

COIN

IS ENERGIZED BY COIN SWITCH OR REPLAY RELAY--ALSO BY 5¢ RELAY, THRU SWITCH ON ALTERNATOR UNIT--ALSO BY 25¢ RELAY, IF GAME IS ADJUSTED TO "6 PLAYS FOR 25¢".

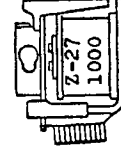
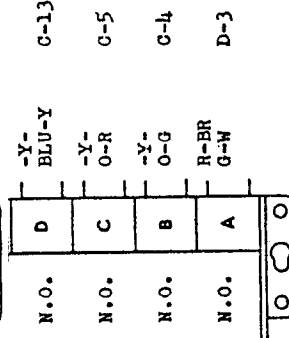

EJECT

IS ENERGIZED BY EJECT POCKET SWITCH, THRU SCORE MOTOR INDEX CAM SWITCH D.

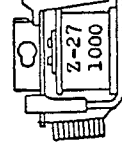
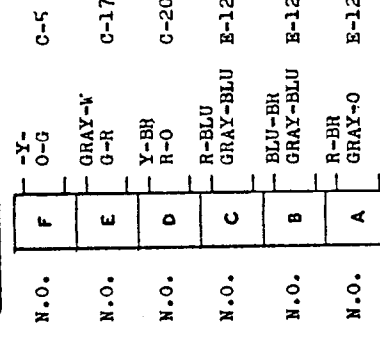

OPENS IN CIRCUIT TO REPLAY RELAY AND COIN LOCKOUT COIL--CLOSERS TO RUN SCORE MOTOR.

ENERGIZES BONUS RELAY, THRU INDEX CAM SWITCH D.

IN HOLD CIRCUIT TO THIS RELAY.

OPENS MOST CIRCUITS TO PLAYFIELD SWITCHES.

OPENS IN CIRCUIT TO COIN UNIT S.U. COIL AND CLOSERS TO RESET COILS ON COIN, BALL COUNT AND GAME-OVER.

IN CIRCUIT TO PLAYER UNIT RESET COIL.

ENERGIZES 115 VOLT RELAY BANK RESET COIL, THRU SCORE MOTOR CAM SWITCH 3A.

OPENS CIRCUIT TO COIN LOCKOUT COIL.

PULSES REPLAY UNIT RESET COIL, THRU CAM SWITCH 1B.

ENERGIZES COIN RELAY.

IN HOLD CIRCUIT TO THIS RELAY.

TRIPS GAME-OVER RELAY, THRU ZERO SWITCH ON PLAYER UNIT OR BALL COUNT UNIT.

ENERGIZES RESET RELAY, THRU SWITCH C ON GAME-OVER RELAY.

RUNS SCORE MOTOR.

IN HOLD CIRCUIT TO THIS RELAY.

RUNS SCORE MOTOR.

IN CIRCUIT TO PULSE 100 OR 1,000 POINT RELAY, THRU NUMBER MATCH UNIT DISC.

IN CIRCUIT TO ENERGIZE TOP GATE RELAY OR BOTTOM GATE RELAY, THRU NUMBER MATCH UNIT DISC.

PULSES EJECT COIL, THRU CAM SWITCH 4B.

ENERGIZES BONUS UNIT S.U. COIL, THRU CAM SWITCH 4B.

IN HOLD CIRCUIT TO THIS RELAY.

EXTRA BALL

IS ENERGIZED BY TRIPLE BONUS RELAY, THRU LEFT BOTTOM (INSIDE) ROLLER SWITCH--- ALSO BY HI-SCORE CIRCUIT, THRU "REPLAY-EXTRA BALL" ADJUSTMENT JACK.

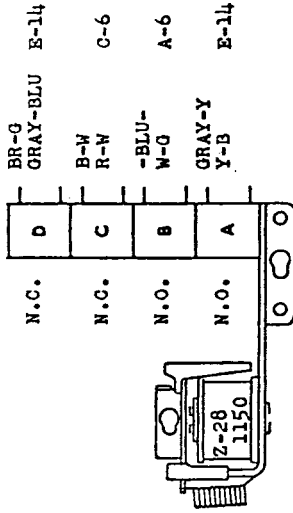

IN CIRCUIT TO ENERGIZE BALL INDEX RELAY.

IN SERIES WITH SWITCH B ON BALL INDEX RELAY.

TO "SHOOT AGAIN" LITES.

IN HOLD CIRCUIT TO THIS RELAY.

GAME-OVER INTERLOCK

LATCH COIL IS ENERGIZED BY SCORE MOTOR GAM SWITCH 1B, THRU COIN RELAY AND RESET RELAY. TRIP COIL IS ENERGIZED BY LOCK RELAY OR WIPER FINGER ON BALL COUNT UNIT---ALSO BY COIN RELAY, THRU A ZERO SWITCH ON EITHER THE BALL COUNT UNIT OR PLAYER UNIT.

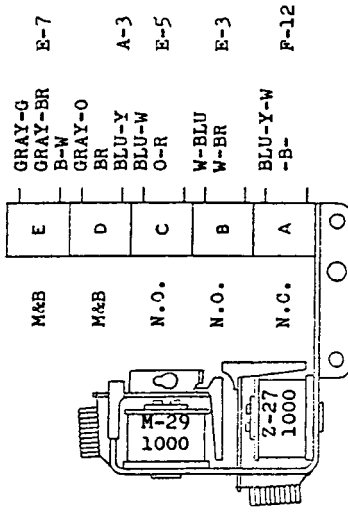

OPENS IN HI-SCORE CIRCUITS AND CLOSSES TO NUMBER MATCH CIRCUITS.

OPENS TO "PLAYER UP" LITES AND CLOSSES TO "GAME-OVER" AND "NUMBER MATCH" LITES.

IN CIRCUIT TO RESET RELAY, THRU SWITCH ON COIN RELAY.

IN CIRCUIT TO REPLAY RELAY.

OPENS MOST CIRCUITS TO PLAYFIELD SWITCHES.

BALL INDEX

IS ENERGIZED BY 10 POINT, 100 POINT OR 1,000 POINT RELAY, THRU SWITCH ON EXTRA BALL RELAY---ALSO BY TILT RELAY.

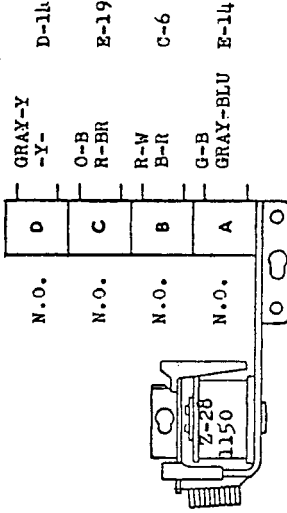

IN SERIES WITH SWITCH A ON EXTRA BALL RELAY.

IN CIRCUIT TO 1,000 POINT RELAY WHEN COLLECTING BONUS.

IN CIRCUIT TO BALL COUNT S.U. COIL---ALSO IN SERIES WITH SWITCH C ON PLAYER RESET RELAY.

IN HOLD CIRCUIT TO THIS RELAY.

TILT

IS ENERGIZED BY PLUMB BOB TILT, BALL ROLLOVER TILT OR PLAYFIELD VIBRATION TILT SWITCH.

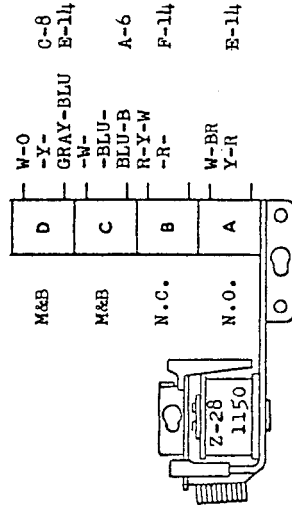

OPENS IN HI-SCORE CIRCUIT TO REPLAY S.U. AND CLOSSES TO ENERGIZE BALL INDEX RELAY.

OPENS IN CIRCUIT TO MOST PLAYFIELD LITES AND CLOSSES TO "TILT" LITE.

OPENS CIRCUITS TO MOST PLAYFIELD SWITCHES.

HOLD CIRCUIT TO THIS RELAY, THRU SWITCH ON OUTHOLE RELAY.

25¢

IS ENERGIZED BY 25¢ COIN SWITCH.

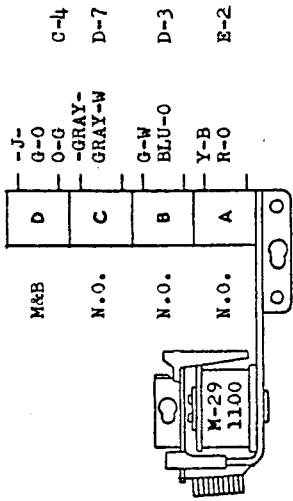

OPENS IN CIRCUIT TO KNOCKER COIL AND CLOSSES TO RUN SCORE MOTOR.
 PULSES REPLAY S.U. COIL, THRU IMPULSE CAM SWITCH B.
 ENERGIZES COIN RELAY IN "6 PLAYS FOR 25¢" ADJUSTMENT.
 IN HOLD CIRCUIT TO THIS RELAY.

10¢

IS ENERGIZED BY 10¢ COIN SWITCH, IF 10¢ ADJUSTMENT JACK IS IN "2 PLAYS" OR "3 PLAYS" ADJUSTMENT JACK.

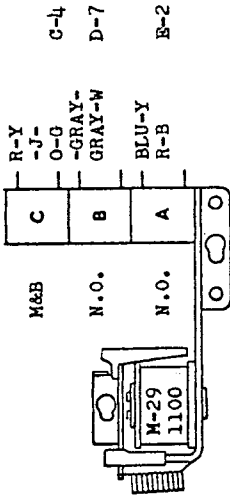

OPENS IN CIRCUIT TO KNOCKER COIL AND CLOSSES TO RUN SCORE MOTOR.
 PULSES REPLAY S.U. COIL, THRU IMPULSE CAM SWITCH B.
 IN HOLD CIRCUIT TO THIS RELAY.

5¢

IS ENERGIZED BY 5¢ COIN SWITCH.

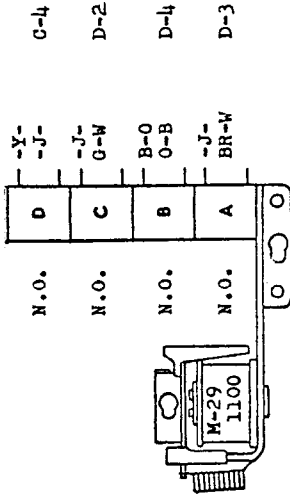

ENERGIZES ALTERNATOR UNIT S.U. COIL.
 ENERGIZES COIN RELAY, THRU SWITCH ON ALTERNATOR UNIT.
 ENERGIZES LOCK RELAY.
 IN HOLD CIRCUIT TO THIS RELAY.

BOTTOM GATE

IS ENERGIZED BY EJECT RELAY, THRU NUMBER MATCH UNIT DISC AND CAM SWITCH 1E.

LOCATED ON PLAYFIELD.

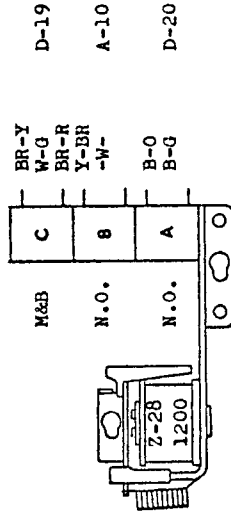

OPENS IN CIRCUIT TO 1,000 POINT RELAY AND CLOSSES TO 5,000 RELAY (WHEN MAKING RIGHT BOTTOM ROLLOVER SW.).
 TO "BOTTOM GATE" LITE.
 HOLD CIRCUIT TO THIS RELAY, THRU BOTTOM TROUGH SWITCH.

50 POINT

IS ENERGIZED BY TARGET SWITCHES 1A, 2A, 3A, 1D, 2D OR 3D.

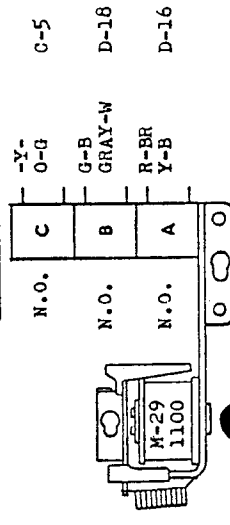

RUNS SCORE MOTOR.
 IN CIRCUIT TO PULSE 10 POINT RELAY.
 IN HOLD CIRCUIT TO THIS RELAY.

5000

IS ENERGIZED BY TOP TROUGH SWITCH, THRU TOP GATE RELAY---ALSO BY RIGHT BOTTOM ROLLOVER SWITCH, THRU BOTTOM GATE RELAY.

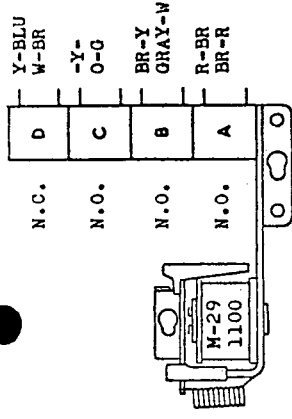

ADVANCE

IS ENERGIZED BY LEFT SIDE, RIGHT SIDE OR CENTER TARGET SWITCH---ALSO BY RIGHT TOP STAND-UP SWITCH.

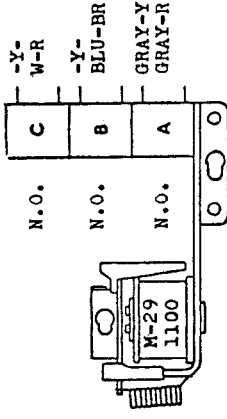

SPECIAL

IS ENERGIZED BY CENTER TARGET SWITCH, THRU 12 SWITCHES IN SERIES ON 1, 2 AND 3-A, B, C AND D RELAYS AND SWITCH ON REPLAY CONTROL RELAY.

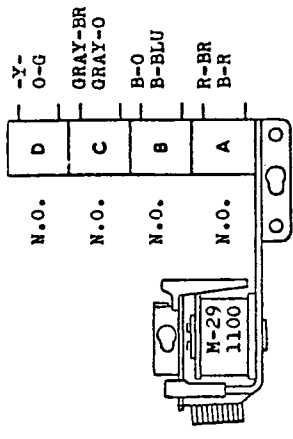

BONUS

IS ENERGIZED BY RESET RELAY, THRU INDEX CAM SWITCH D---ALSO BY OUTHOLE SWITCH, THRU OUTHOLE RELAY AND INDEX CAM SWITCH D.

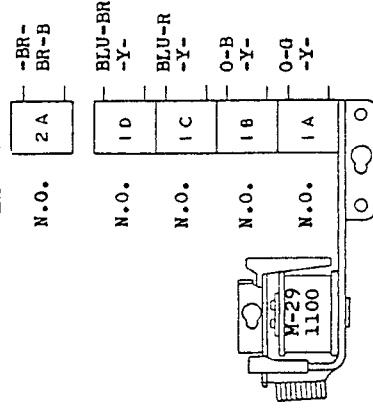

TOP GATE

IS ENERGIZED BY EJECT RELAY, THRU NUMBER MATCH UNIT DISC AND CAM SWITCH 1E.

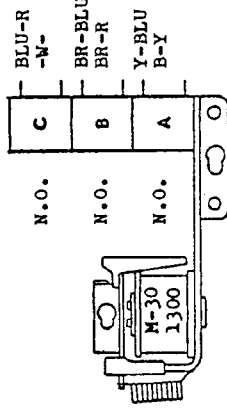

IN HOLD CIRCUIT TO TOP GATE RELAY.

RUNS SCORE MOTOR.

IN CIRCUIT TO PULSE 1,000 POINT RELAY.

HOLD CIRCUIT TO THIS RELAY, THRU CAM SWITCH 5B.

PULSES 100 POINT RELAY.

ENERGIZES BONUS UNIT S.U. COIL.

HOLD CIRCUIT TO THIS RELAY, THRU END-OF-STROKE SWITCH ON BONUS UNIT.

RUNS SCORE MOTOR.

IN CIRCUIT TO SCORE A REPLAY OR EXTRA BALL, THRU "CENTER TARGET ADJUSTMENT JACK".

ENERGIZES "REPLAY CONTROL RELAY", THRU SCORE MOTOR CAM SWITCH 3A.

IN HOLD CIRCUIT TO THIS RELAY.

HOLD CIRCUIT TO THIS RELAY, THRU ZERO POSITION SWITCH ON BONUS UNIT.

IN HOLD CIRCUIT TO RESET RELAY.

IN SERIES WITH SWITCH 27B ON DOUBLE BONUS RELAY (ON RELAY BANK).

IN SERIES WITH SWITCH 28B ON DOUBLE BONUS RELAY.

RUNS SCORE MOTOR.

TO "TOP GATE" LITE.

ENERGIZES 5,000 RELAY, THRU TOP TROUGH SWITCH.

IN HOLD CIRCUIT TO THIS RELAY.

10 POINT

IS PULSED BY:

1. STAND-UP SWITCHES.
2. KICKER SWITCHES.
3. 50 POINT RELAY.

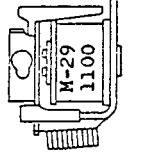

IN SERIES WITH SWITCH A ON EXTRA BALL RELAY.

IN HOLD CIRCUIT TO THIS RELAY.

PULSES 10 POINT DRUM UNITS, THRU PLAYER UP UNIT DISC.

ENERGIZES MEDIUM CHIME COIL.

IN SERIES WITH SWITCH D ON EXTRA BALL RELAY.

PULSES 100 POINT RELAY, THRU 9TH POSITION SWITCHES ON 10 POINT DRUM UNITS.

100 POINT

IS PULSED BY:

1. ADVANCE RELAY.
2. EJECT RELAY, THRU NUMBER MATCH UNIT DISC.
3. TARGET SWITCHES 1B, 2B, 3B, 1C, 2C AND 3C.
4. (3) JET BUMPER SWITCHES.

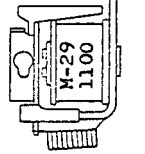

IN SERIES WITH SWITCH 2B ON 10 POINT RELAY.

IN SERIES WITH SWITCH D ON EXTRA BALL RELAY.

IN HOLD CIRCUIT TO THIS RELAY.

PULSES 100 POINT DRUM UNITS, THRU PLAYER UP DISC.

PULSES NUMBER MATCH S.U. COIL, THRU SCORE MOTOR INDEX CAM SWITCH C.

ENERGIZES SMALL CHIME COIL.

PULSES 1,000 POINT RELAY, THRU 9TH POSITION SWITCHES ON 100 POINT DRUM UNITS.

1000 POINT

IS PULSED BY:

1. EJECT RELAY THRU NUMBER MATCH UNIT DISC.
2. 5,000 RELAY.
3. LEFT BOTTOM (INSIDE) ROLLOVER SWITCH.
4. LEFT BOTTOM (OUTSIDE) ROLLOVER SWITCH.
5. RIGHT BOTTOM ROLLOVER SWITCH, THRU BOTTOM GATE RELAY.
6. BONUS RELAY, THRU SWITCH ON DOUBLE BONUS RELAY (WHEN COLLECTING BONUS).

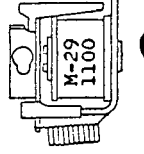

OPENS IN SERIES WITH SWITCH 2C ON 100 POINT RELAY AND CLOSES IN SERIES WITH SWITCH D ON EXTRA BALL RELAY.

IN HOLD CIRCUIT TO THIS RELAY.

PULSES 1,000 POINT DRUM UNITS, THRU PLAYER UP DISC.

PULSES 10,000 POINT DRUM UNITS, THRU 9TH POSITION SWITCHES ON 1,000 POINT DRUM UNITS.

ENERGIZES LARGE CHIME COIL.

IN HI-SCORE CIRCUIT TO REPLAY S.U. COIL OR EXTRA BALL RELAY.

N.C.	2 B	-J- GRAY-Y	E-14
N.O.	2 A	W-BLU G-B	E-18

N.O.	1 D	BR-O W-O	C-9
N.O.	1 C	-O- -Y-	C-22
N.O.	1 B	-Y- BR-G	C-14
N.O.	1 A	B-G W-R	E-17

N.C.	2 C	-J- -J-	D-14
N.O.	2 B	-Y- BR-G	C-14
N.O.	2 A	W-B W-R	E-17

N.O.	1 D	R-G W-O	C-10
N.O.	1 C	BLU-W BR-B	D-22
N.O.	1 B	O-R -Y-	C-22
N.O.	1 A	BR-Y O-BLU	E-18

M&B	2 B	-J- -Y-	C-14 C-14
N.O.	2 A	BLU-R BR-Y	E-18

N.O.	1 D	-W- W-O	C-11
N.O.	1 C	-BR- W-O	C-11
N.O.	1 B	-Y- B-G	C-22
N.O.	1 A	-BLU- B-W	F-8

1 1/2 RESET

IS PULSED BY IMPULSE CAM SWITCH F, THRU SWITCH 2A ON RESET RELAY.

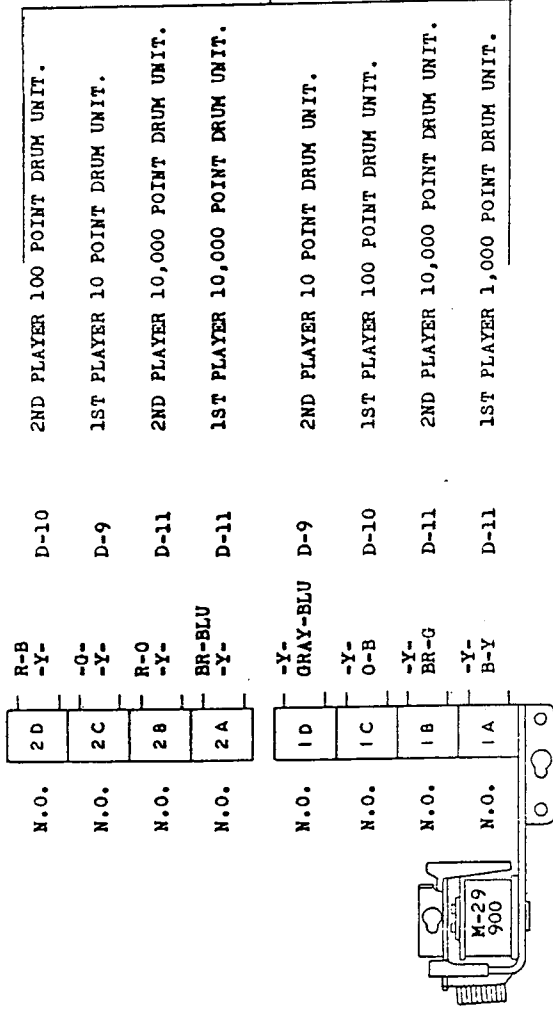

THESE SWITCHES PULSE THE INDICATED DRUM UNIT, THRU ZERO SWITCH ON THAT UNIT.

3 1/4 RESET

IS PULSED BY IMPULSE CAM SWITCH A, THRU SWITCH 2A ON RESET RELAY.

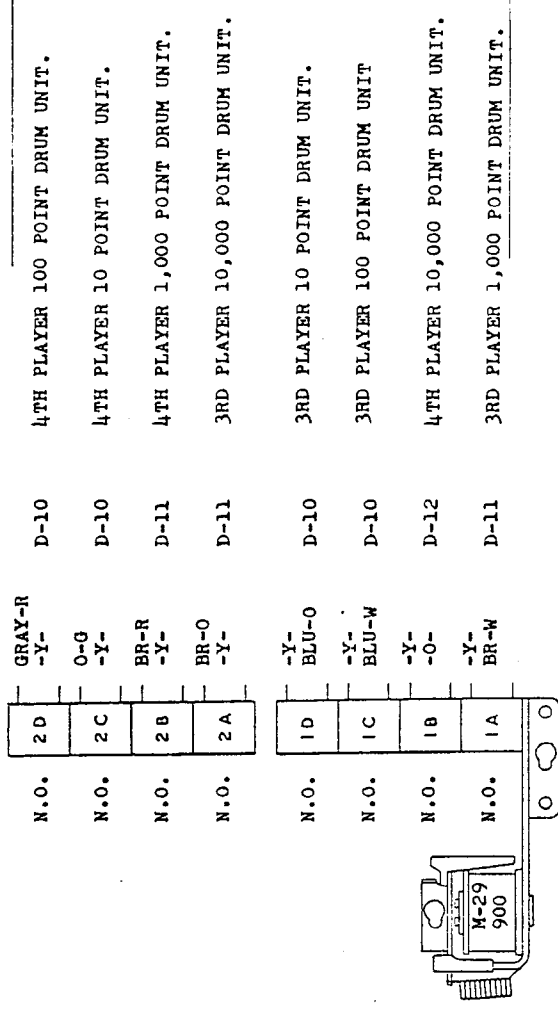

THESE SWITCHES PULSE THE INDICATED DRUM UNIT, THRU ZERO SWITCH ON THAT UNIT.

CATALOG
SUPPLEMENT "J-J-J"

WITH
NEW PARTS & UNITS

FOR
STRATO-FLITE
&
SUPER-FLITE



Williams[®] ELECTRONICS

A DIVISION OF THE SEEBURG CORPORATION OF DELAWARE

3401 N. California Ave.
(312) 267-2240

AUGUST
1974

Chicago, Ill. 60618, U.S.A.
Cable Address: Wilcoin

PRICE LISTARRANGED IN NUMERICAL ORDER

<u>PART NO.</u>	<u>DESCRIPTION</u>	<u>PRICE</u>
1A-624	Mounting Bracket.....	.10
1A-2048	Switch Cover Plate.....	.03
1A-2646	Target Switch Plate.....	.14
1B-3233	"J" Relay Mounting Frame.....	.97
1A-3863	Mounting Bracket-Relay.....	.76
1A-3864	Mounting Bracket - Gate.....	.56
1A-6106	Spacer for Playfield Plastic.....	.72
3A-7264-6	Plastic Target - Yellow.....	.18
11D-192-DD-A	Wood Playfield Arch.....	5.20
12A-6368	Wireform No. 1 - Link.....	.29
12A-6369	Wireform No. 2 - Gate.....	.66
30C-445	Playfield Plastics - "Strato-Flite" set of 7....	20.70
M-30-1300	"M" Relay Coil.....	2.10
SW-1M-1S	Make Switch.....	.70
SW-1M-3S	Make Switch.....	.70
SW-10A-42	Target Switch.....	1.00
A-6515	"J" Relay Armature Assembly.....	1.38
B-6607-2	Ball Gate Assembly Complete.....	12.20
A-7518-1	Target Switch Assembly.....	1.74
	#5 x 7/8 Flat Head Woodscrew - Phillips.....	.01

B-6607-2
BALL GATE ASSEMBLY

