

JAMECO[®]

ELECTRONICS

Volume 233
August 2003

99% In-Stock

Low-Price
Guarantee

Popular and
Hard-to-Find
Items

**Your Power
Connection to
Electronic Values**

1-800-831-4242

www.Jameco.com

Medical Power Supplies

65-Watt Open Frame Low Leakage

MPS-65 Series: Single Output

The Mean Well MPS-65 series of medical power supplies are low cost, high reliability open-frame power supplies that feature a low leakage current of 0.3mA@264VAC. These power supplies feature universal input of 88-264VAC, as well as 120-370VDC for battery-powered applications. Full rated power is available with 18 CFM forced air convection. Safety protections include short-circuit, overload, and over-voltage. They are approved by UL and TUV, and carry a CE mark for use worldwide.

- 100% full load burn-in test
- -10°C to + 60°C working temperature
- High-efficiency, low working temperature
- Soft-start circuit limits AC surge current
- Universal AC input
- 105°C output capacitor
- 2.4 watts/in³
- Three-year warranty



Detailed specs & complete line of Medical Power Supplies on pages 32-33.

Part No.	Description	1	10
221188CD	Medical Power Supply	\$36.95	\$31.99

Be sure to see our many new high-performance, cost-effective test instruments.

For Jameco's complete selection of test & measurement equipment see, pages 138-154.

To get the job done right you need the right instrument! We've expanded our lines of digital multimeters, time/temperature/environmental meters, scopes and all the test leads and accessories needed for any purpose.



The brand names you recognize and trust



Whether you need a \$2,500 o'scope or a \$9.95 digital multimeter, you can find great new values at Jameco Electronics.

Shopping for a new DMM?

Check our easy-to-use reference guide on page 142.

Jameco continues to expand its line of connectors, wire and cable.



See pages 124-135 for our latest selection.

Get Connected with Name-Brand Quality

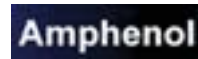

Now you can get AMP, AMPHENOL and MOLEX connectors from Jameco. We've expanded our line of D-SUB, UHF, BNC, and power connectors from these leading connector manufacturers. So whether you need data, RF or power connectors, be sure to thumb through pages 124 - 135. You'll find a wide range of connectors, including zinc and tin plated D-SUB connectors with or without grounding indents. We have crimp and solder-cup wire shells, as well as various crimp pins that can accept different wire gauges. Plus, you'll also find Amphenol UHF and BNC connectors for different applications and cables, and MOLEX .062" and .093" power connectors with various circuit designs and crimps pins. For more detailed spec sheets, visit our website at www.Jameco.com

New! Cat 6 Networking Cables



Why cable your building with antiquated wire whose bandwidth is stressed in today's common networking applications? Use Category 6 cables and connectors so you won't have to rewire your business tomorrow! Cat 6 compliant products will likely be the emerging 10GBASE-T networking specification's standard, and cables/connectors are now readily available. So be sure to visit our network cable section on pages 190-195. And don't forget to visit our website at www.Jameco.com for our latest Cat 6 connector offerings.

Complete line of Category 6 Cables on page 193.

Pro-Video Editing Controller

CommandPost is a pro-quality video-editing controller for your favorite video/multimedia applications at a new breakthrough special purchase price. Working with your favorite video/multimedia applications has never been easier or faster. Now the most popular controls such as jog wheel, fader, etc., from professional non-linear editors, DVEs and DDRs are brought to your desktop. Includes a free copy of VideoWave Version 4.0 video editing software plus templates for most popular video and graphics applications, including Videonics Effetto Pronto, Apple iMovie, Apple Final Cut Pro, Adobe Premiere, Adobe After Effects, and Digital Origin EditDV.



Just \$29.95

P/N 220329CD – See page 175 for complete specifications.

New Products & New Lines

Based on customer feedback, we continue to add new products and product lines to our catalog. In this issue, you'll find the latest Cat 6 networking cables, new hand and power tools, name brand connectors, medical power supplies and more.

Get the New Products You Need!

Our merchandising department is growing, and now we're able to add more of the products you want. Your feedback will help us provide you with a complete electronic components solution, shortening your buying time and allowing more time with the technology. So please take a few minutes and visit our web site today at www.Jameco.com/CorpProducts.

Office Products

Power Supplies



Test Equipment



Tools



Cat 6 Cables



Personal Security



Connectors

See detailed Product Index on pages 219-221 & Manufacturer's Index on page 222.

Power Products5-59

Fans & Heat Sinks.....60-63

Motors & Motion Control.....64-67

Integrated Circuits.....68-77

Transistors, Diodes & Heat Sinks77-82

Surface Mount Components.....83-85

Electronic Components86-92

Optoelectronic Components.....93-99

Electromechanical Components ..100-111

Electronic Design.....112-120

Interconnect & Hardware.....121-135

Audio.....136-137

Test Equipment138-154

Soldering Equipment.....155-159

Tools160-168

Computer & Security169-199

Educational Kits200-213

Books214-216

Order Info, Order Form, Product & Manufacturers' Index 217-222

New Products, Late Additions 1-3, 223-225

PRICES

Prices are effective 7-14-03.
Prices and discounts are subject to change without notice.



Remotely Activated Surge Suppression



Remote control mounts neatly to the side of your monitor

Limited Quantities!
Only \$39.95
Suggested Retail \$169.95

Use our remotely controlled surge suppressor and stop crawling under your desk or flipping on your equipment power with your toe. Just place the small remote control strip anywhere easily at hand, up to 6 feet away from the base unit. Attach the remote to the side of your monitor with the enclosed adhesive strips if you like to keep your desktop clear. Then power up 4 plugs, or turn off specific outlets with a touch of a button. One plug stays live continuously. The extra long power cord lets you place the base unit up to 9 feet from your wall outlet.

Free \$25,000 Equipment Protection Policy

Kensington is so sure their product will protect both your equipment and phones that they back it up with The Kensington Limited Lifetime Warranty that protects your equipment for up to \$25,000 against damage (see package for details).

- EMI/RFI filtering: attenuation up to 40dB with frequency range of 600kHz-26MHz • Energy rating: 420 joules (140 each line)
- Clamping voltage: 330V; telephone protection @ 465V
- Size: (outlet strip) 12.5"L x 3.0"W x 3.5"H; (remote) 6.5"L x 2.0"W x 1.0"H
- Current peak: 39,000A • 15A circuit breaker • UL listed
- 5 outlets/3 switches • Failure indicator light • Wt.: 2 lbs.

Part No.	Description	1	5
211203CD	Surge suppressor with remote	\$39.95	\$35.95

Give Your Eyes A Break!



Glare-Free Computer Light



Glare-Free Document Light

Finally, a lamp that lets you work hours longer without eye fatigue or overheating. The ingeniously designed Eclipse Computer Light provides the soft, cool, glare-free light recommended by optometrists. The secret is a bulb concealed in the base, and an airfoil-shaped hood that reflects light softly, so you see your work, but not the light. The cool 13-watt bulb lasts 10,000 hours and can be replaced at most hardware or lighting stores. Mounts securely with double-sided foam tape. Compact mounting pad even fits flat-panel monitors. 8"H x 10"W x 4"D. For glare-free illumination of your documents, add the Glare-Free Document Light & Copyholder. Mounts on either side of your monitor and flips back when not in use. Both include AC power cords with adapter and a 5-year manufacturer's guarantee!

Part No.	Description	Price
224303CD	Glare free eclipse executive computer light	\$38.49
224311CD	Glare free document light and holder	29.95

Low-Leakage Medical Power Supplies

Does your application require Medical and/or low leakage current Power Supplies? Jameco just added 24 medical-grade power supplies to its line, all

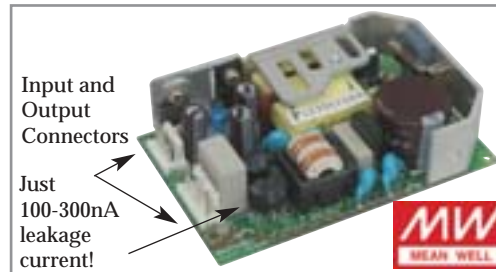

Input and Output Connectors
Just 100-300nA leakage current!

featuring low (100-300 nA) leakage currents. Now you can save money on these high-reliability power supplies and get them from a name trusted for over 28 years. And since over 99% of our products are in-stock, you know you'll get them delivered to your project quickly and effortlessly. Our complete line is featured on pages 32-33. And of course, you can always visit www.Jameco.com for our latest offerings.

5MHz Handheld Oscilloscope with Multimeter

An alternative to lugging a heavy oscilloscope wherever you work!

Now you can carry a scope with you wherever you go! This practical handheld DMM with true RMS can be

P/N 221962CD
See page 139 for complete specifications.



used together with the built-in 5MHz oscilloscope, so you can view actual signals too! View the noise levels on network and other communications cables, and visually assess waveform distortion without having to carry a cumbersome device. Plus, the included RS-232C interface allows you to download measurements into a notebook or laptop PC for later analysis.

Retractable USB and Firewire Cables



Starting at Just \$11.95

For our latest selection of ZipLinq Cables see page 183.

Carrying all those extra cables for your computer peripherals such as printers, cameras, zip drives and external hard drives, adds weight and gets tangled in your computer bag. With these retractable USB and Firewire cables, you can easily store them in an inside

pocket of your bag; plus it is tangle free. Just pull the cable on both ends of the spool and you have a high quality cable that extends to over 2'. Simply pull again and it retracts back into its housing.

Powerful Cordless Screwdriver Set

Complete set includes: crewdriver, 2 magnetic bit holders, 11-piece bit set and power supply.



Save time and your wrist with those stubborn screws. This 4.8 volt rechargeable cordless screwdriver features a spindle lock for greater control and a 180 RPM motor that produces 40 in./lb. of torque for starting and finishing screws. Comes with 2 magnetic bit holders, 11-piece bit set (5 slotted, 3 Phillips, 3 torque), and power supply; all at no extra cost.

- Narrow nose for extended reach in tight places
- Construction grade quality
- Size: 10.5"
- Recharges in 7 - 9 hours
- Weight: 1.38 lbs.

Part No.	Description	1	5
211254CD	Cordless screwdriver	\$18.95	\$17.95

Improve Quality of SMT Repair

Engineered to meet the demanding needs of today's electronic industry such as technician service, repair centers, and assembly work. Now you can replace surface mount devices or dual-in-line components in a snap. It not only increases productivity in SMT assembly and repair, but achieves a new standard of quality, superior performance, and ease of operation.

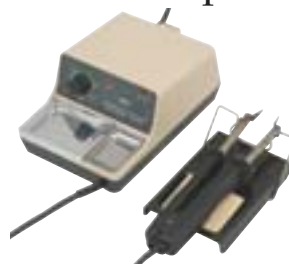

- High-performance, inexpensive, versatile
- Adjustable temperature: 250°C - 450°C (482°F - 842°F)
- Thermocouple sensor for stable temperature
- 40W station, 25W ceramic element
- Long-life ceramic heating element
- Rapid heat-up and recovery
- Size: 7.4"L x 5.0"W x 3.3"H
- Weight: 2.6 lbs.

Includes: Base power unit, sponge, stand, surface mount tweezer iron & stand

Part No.	Description	1	10	25
224629CD	SMT rework station	\$89.95	\$80.99	\$72.85

Jacob Jensen Designed Phones By Enzer

"Phones must be functional, but who said they should not look great?"

Enzer Electronics has positioned itself as a leader in the telecommunications technology industry that emphasizes the beauty and design of its products. The perfect blend between technology and visual arts will satisfy both your senses and your emotions. They offer more than just technology - it's about innovation and intelligent ideas that defy your expectations! Jacob Jensen, the world famous designer who has won over 100 international prizes and 18 of his works exhibited at the Museum of Modern Art in New York has teamed up with Enzer to bring you beauty and functionality in phones for your business or home office.



Image of Jacob and son



227125CD

227125CD 2 one-touch memory, 10 two-touch memory, mute/flash/pause function, ringer volume (Hi/Low), last number redial, desktop/wall mountable

227141CD One-touch memory, ringer melody control (3 melodies), 10 two-touch memory, mute/flash/pause function, ringer volume (Hi/Low), last number redial, desktop/wall mountable

227133CD 10-digit LCD display, 3 one-touch memory, 10 two-touch memory, mute/flash/pause function, ringer volume (Hi/Low), last number redial, desktop/wall mountable



227133CD

227150CD 3-line alphanumeric LCD backlight display; Caller ID; 3 direct and 10 redial memory; last number redial; 66 caller ID memory; 77 phone book memory; display of caller's phone number, time, and date simultaneously; 11 language operation; two-way speaker phone; FSK/DTMF/Dual mode selectable; desktop/wall mountable



227141CD



227150CD

Part No.	Description	Price
227125CD	Desktop/wall mountable phone	\$79.95
227133CD	Desktop/wall mountable phone w/ LCD	109.95

Part No.	Description	Price
227141CD	Desktop/wall mountable phone (3 ringer melodies)	\$59.95
227150CD	Desktop/wall mountable phone w/ LCD and Caller ID	99.95

Noise Canceling Headphones and Cell Phone Headset

Our new noise-canceling headphones eliminate "acoustic junk" noise from cars and machines that causes stress and leads to anxiety and problems with concentration. The NoiseGard system filters out that fatiguing, annoying noise and really lets you enjoy your favorite music.

Also, our new MAB-18 cell phone headsets are the first in-ear system for mobile telephones. It offers a flexible microphone arm, cable clip and the possibility of left or right wearing style. It comes with a 2.5mm jack plug that is compatible with most mobile phones.

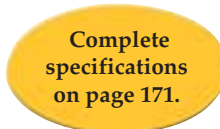

Noise Canceling Headphones P/N 227088CD

Cell Phone Headset P/N 227096CD



The Jameco Advantage Same Day Shipping – FREE!

99% of all orders placed by 6 PM EST are shipped the same day, so you can have it quicker at no additional cost!

Low-Price Commitment

We'll match the printed ad price of any like product in this catalog. Just call us. It's that simple!

Around-the-Clock Ordering

Call us any time, day or night, weekday, weekend or holiday; at 1-800-831-4242 to place your order. Of course, you can order on the web too! www.Jameco.com



Help Avoid Duplicate Catalogs

While we don't intend to send multiple catalogs to the same person, on occasion we do make mistakes. If you're incorrectly receiving multiple catalogs, please visit our web site at www.Jameco.com/DupCats and we'll remove the duplicates. Alternatively, you can mail the duplicate back-covers/mailling label(s) to us:



Jameco Electronics - Duplicate Catalogs
1355 Shoreway Rd., Belmont, CA 94002

Open an Account Today!

It's easy to open an account at Jameco. Simply call us or visit www.Jameco.com and we'll take the information over the phone. If it's more convenient, we can fax you a credit application right away. And don't worry about time. Most applications are processed within minutes.



Just in Time Stocking – Get It at Jameco

Take advantage of our "Just In Time" fast delivery. Jameco has stocking levels that guarantee 99% in-stock availability, without the exceptions others may impose. Place your order any weekday before 6:00 PM EST, and you can be assured your order is on its way that day!



Our Low-Price Guarantee

Doesn't Get Much Use...

... and we like it that way! But it is offered for a good reason. We take our pricing and product sourcing seriously, searching around the world to identify sources for the lowest prices and highest quality products.



We've Added Resources

Many of the products we offer have free technical documents online, so you don't have to wait for snail mail. And in addition to placing orders on the web, you can also request RMAs. For more information visit www.Jameco.com today!



Contact Information

Order Desk 24/7, 365 Days a Year
Phone: 1-800-831-4242
Fax: 1-800-237-6948
E-mail: sales@Jameco.com

Website www.Jameco.com

International Order Desk
Phone: 650-592-8097
Fax: 650-592-2503
E-mail: international@Jameco.com

Technical Support
Phone: 1-800-831-4242
E-mail: tech@Jameco.com

Customer Service
Phone: 1-800-831-4242
E-mail: custservice@Jameco.com

Credit Department
Phone: 650-592-8097
E-mail: credit@Jameco.com

International Toll-Free Fax Numbers
Columbia: 980-9-136748
Mexico: 001-800-593-1449
Indonesia: 1-803-015-237-6948
Brazil: 000-817-455-6119
New Zealand: 080-044-0470

Identify Products Faster!

Looking for new products or great savings? Now you can find both faster with our simplified legend!



Find New Products Quickly



Look for the part numbers in red. We've added a complete line of power products, as well as hundreds of other products.

Part No.	Product No.
182991	RMH08LP

Save with Quantity Discounts



Buy in quantity and save! Corporate buyers will especially appreciate savings up to 54% off single unit prices. Look for products highlighted in green.

Part No.	Description	1	10
156785	Soldering station	\$69.95	\$62.95
156814	Sharp conical tip	4.95	4.49
134633	Replacement sponge	2.99	2.49

Save on Sale Items!

Sale products are highlighted in yellow, so you can identify items whose prices have been reduced in all quantities.



Part No.	Product No.	Qty	Description	1	10
44222	7402	14	Quad 2 Input NAND gate	1.49	1.39
40538	7402	14	Quad 2 Input NAND gate	19	14
44221	7404	14	Hex Inverter (CD4069)	.89	.85

Last Chance Opportunities

Unfortunately we're not always able to restock certain hard-to-find products. In this case we'll print blue part numbers, so if we know there's limited stock, you'll also know.

Part No.	Product No.
155643	DC603F1

Hard-to-Find Products

Some products are no longer produced, and yet we know you need them. That's why we occasionally offer pulled or refurbished products. Pulled part numbers are clearly printed in purple and refurbished in brown. Each is backed by our standard Jameco warranty.

Part No.	Product No.
121232	AW10D1GA

Part No.	Product No.
25101	MC146818

Switching Power Supplies for Every Application

Computer Power Supplies are on page 169.

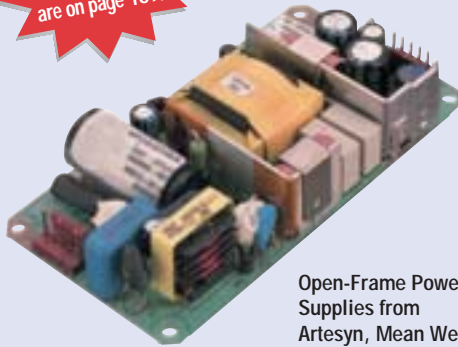

Open-Frame Power Supplies from Artesyn, Mean Well and many others.

For many years, Jameco has been known as a leading source of power supply products. Jameco specializes in providing high levels of personalized service to customers with modest quantity requirements.

Jameco continues to expand its commitment to switching power supplies. In addition to recently offering 29 new pages of power products, new name brands and great savings, we're providing more of the

information you need to make good engineering decisions. And if you have on-going needs, be sure to ask for an Inside Sales representative. Your personal sales rep will be familiar with your unique requirements each time you call.

New Medical Power Supplies are on pages 32-33.



Enclosed Power Supplies from 10 to 1,000 Watts.

Name Brands You Can Trust

Jameco has greatly expanded its line of switching power supplies to better serve your needs. Not only have we signed a new distribution agreement with U.S. branded Artesyn Technologies, one of the world's top suppliers of high quality power products, we have also significantly expanded our value-priced, high-performance line from Mean Well.

Now you can get immediate delivery of many popular Artesyn products and avoid the hassles of going through "large company" distribution channels. Be sure to see pages 6-33 for Artesyn's and Mean Well's switching power supplies, and pages 35-45 for Artesyn's and Mean Well's world-renowned DC-to-DC converters.

Save More in Larger Quantities!

Looking to save even more? We already guarantee the lowest prices, but you can save even more when you purchase from Jameco in larger quantities! Our Inside Sales reps are available at 1-800-831-4242 to get you the best value on your quantity purchases.

Save with Limited Supply Items

In addition to providing you with products suitable for long-term production runs, Jameco also continues to offer limited-supply products at great savings. We've negotiated great deals for these limited availability supplies, and you can be assured we're passing the savings on to you.

New



Qty. Save

SAVE

Make Technical Selections from the Catalog

As part of our commitment to expanding our power supply offering, we have added additional information to help you make informed technical decisions. This includes output derating curves, package dimensions and specifications including output ripple, regulation, certifications, and more. Plus, the charts in this catalog allow you to easily compare specifications of different products.

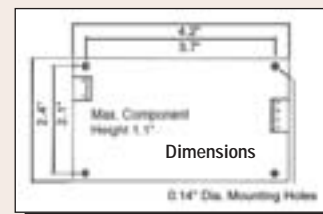
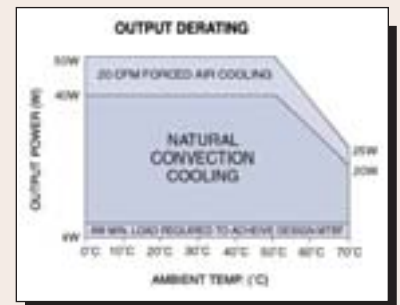

Need more help deciding? You can always call our toll-free tech support hot-line at 1-800-831-4242. Our senior technicians are available to help solve your power supply challenges.

Not sure of the meaning of a power supply term? We've featured numerous explanations throughout the power section offering the definition of the terms used in this catalog and the industry.

UNDERSTANDING POWER SUPPLIES #10 & 11

ISOLATION VOLTAGE: The maximum AC or DC voltage which may be continuously applied from input to output and/or chassis of a power supply.

LEAKAGE CURRENT: The AC or DC current flowing from input to output and/or chassis of an isolated power supply at a specified range.



65-Watt Open Frame with Power Factor Correction

NLP65-96 Series: Single & Triple Outputs

- 100% full-load burn-in
- No minimum load required
- 75 watts with 20 CFM of air
- 1U Package: 5" x 3" x 1.3"
- Mating connectors: P/Ns 104432CD & 104731CD, pg 135
- 0° to +70°C working temperature (see output derating)
- Universal AC input
- 3.3 watts/in³
- Two-year warranty
- Power Factor Correction

Detailed in blue below, the Artesyn NLP65 series are on a 5" x 3" card with maximum component height of 1.26" – one of the smallest in the industry and perfect for 1U applications. With just 20 CFM of air, the power can be boosted 15% to 75 watts from the free-air power of 65 watts. The NLP65 series, with full international safety approvals, and the CE mark, meets conducted and radiated emissions EN55022; and complies to EN61000-4-2/3/4/5/6 immunity standards. The Artesyn NLP65-96 models provide input harmonic current correction (Power Factor Correction) to satisfy EN61000-3-2. If Power Factor Correction is not required, the Artesyn NLP65-76 series is also available in the same package (see pages 12-13).

The NLP65 is designed for use in low power data networking, computer and telecom applications such as hubs, routers POS terminals, internet servers, cable modems and PBXs; as well as many industrial applications.

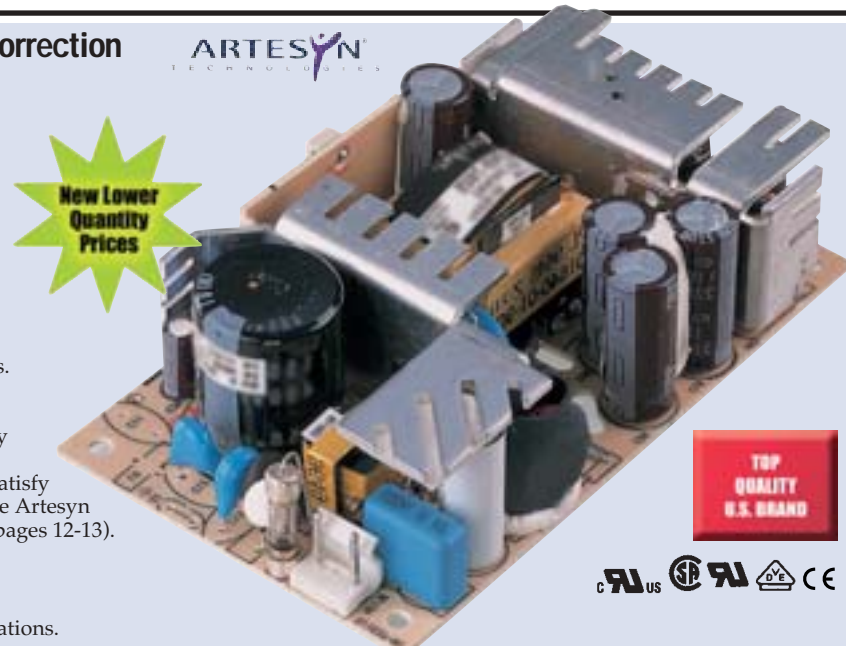

UNDERSTANDING POWER SUPPLIES #6
P.F.C. POWER FACTOR CORRECTION:
 Standard AC/DC converters draw line current in pulses around the peaks in line voltage. This may be undesirable for several reasons. PFC circuits ensure that the line current is drawn sinusoidally and in phase with the sinusoidal line voltage.

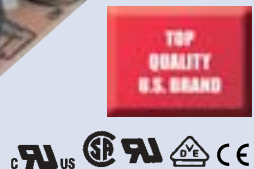
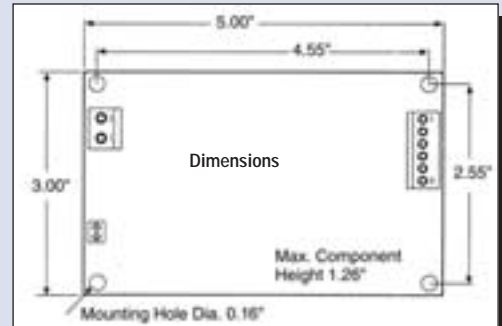
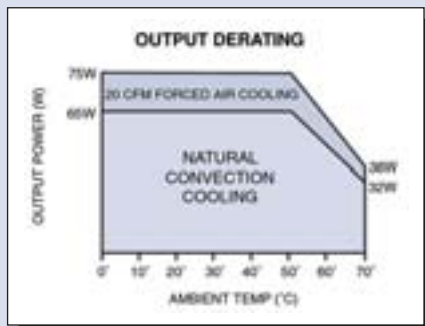

75-Watt Enclosed with Power Factor Correction

SP-75 Series: Single Output

- 100% full-load burn-in
- No minimum load required
- 105°C output capacitor
- Power Factor Correction
- Mating connectors: P/N 103587CD, pg 123
- -10°C to +60°C working temperature (see output derating)
- For mounting accessories see page 224
- Universal AC input
- 2.1 watts/in³
- Three-year warranty

Highlighted in tan below, the Mean Well SP-75 series features input Power Factor Correction that meets EN61000-3-2, required in Europe for power supplies 75 watts and above. They are approved by UL and TUV, and carry the CE mark for use worldwide. The high-density enclosed packaging results in a profile of only 1.3" and a power density of 2.1 watts per inch³. As with all Mean Well power products, every SP-75 product is subjected to 100% full-load burn-in testing. This rigorous production procedure detects infant product failures, contributing to Mean Well's world-class reliability. Protection includes short-circuit, overload and over-voltage.



UNDERSTANDING POWER SUPPLIES #7 & 8
THERMAL PROTECTION: An internal safeguard circuit in a power supply which shuts down the unit in the event of excess internal temperature.
SHORT-CIRCUIT PROTECTION: A feature which limits the output current of a power supply under short-circuit conditions so that the supply will not be damaged.

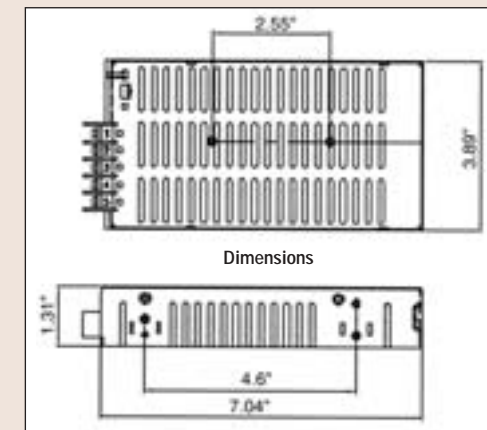
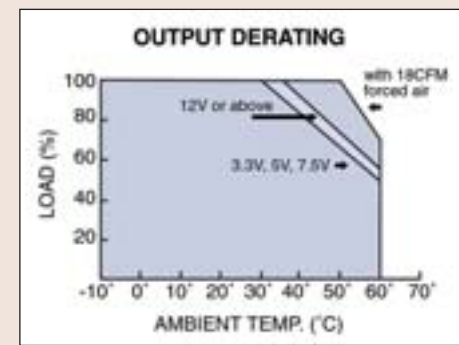

	Manufacturer	Manufacturer Product Number	Output		Input (VAC @ Hz)	PFC	Size Inches (LxWxH)	Mounting Holes Inches (LxWxDia.)	Power Density (W/in ³)	Ripple & Noise (mV p-p)*	Load Reg. (±%)*	Line Reg. (±%)*	Inrush Curr. (A@120VAC)	Isolation Voltage (VAC)	Leakage Current (mA@240V)	Rise Time (ms)	Hold-up Time (ms)	Vibration	Voltage Adjustment (%)*	Efficiency (%)	MTBF (hours)	Weight (lbs.)	Certification	Jameco Part No.	Price		
			Voltage@Current (min-max)	Power																					1	10	25
Open Frame	Artesyn	NLP65-9612	+12V@0-5.4A	64.8W	85-264@47-63	✓	5.00x3.00x1.26	4.55x2.55x0.16	3.32	120	2.0	2.0	17	3,000	0.7	1000	16	5-500Hz; 2.4G	—	72	150,000	0.6	UL/CUL/CSA/VDE/CE	218595CD	\$79.19	\$67.69	\$63.69
	Artesyn	NLP65-9624	+24V@0-2.7A	64.8W	85-264@47-63	✓	5.00x3.00x1.26	4.55x2.55x0.16	3.32	240	2.0	2.0	17	3,000	0.7	1000	16	5-500Hz; 2.4G	—	72	150,000	0.6	UL/CUL/CSA/VDE/CE	218608CD	79.19	67.69	63.69
	Artesyn	NLP65-9608	+5V@0-7.5A; +12V@0-2.5A; -12V@0-0.65A	75.3W	85-264@47-63	✓	5.00x3.00x1.26	4.55x2.55x0.16	3.86	50	2.0	2.0	17	3,000	0.7	1000	16	5-500Hz; 2.4G	—	72	150,000	0.6	UL/CUL/CSA/VDE/CE	218616CD	79.19	67.69	63.69
Enclosed	Mean Well	SP75-5	+5V@0-15A	75.0W	85-264@47-63	✓	see diagram	see diagram	2.11	80	1.0	0.5	40	3,000	2.0	60	20	10-500Hz; 2G	10	72	208,800	1.2	UL/CUL/TUV/CE	194829CD	75.95	55.49	48.99
	Mean Well	SP75-12	+12V@0-6.3A	75.6W	85-264@47-63	✓	see diagram	see diagram	2.13	80	0.5	0.5	40	3,000	2.0	60	20	10-500Hz; 2G	10	77	208,800	1.2	UL/CUL/TUV/CE	194837CD	75.95	55.49	48.99
	Mean Well	SP75-15	+15V@0-5A	75.0W	85-264@47-63	✓	see diagram	see diagram	2.11	80	0.5	0.5	40	3,000	2.0	60	20	10-500Hz; 2G	10	79	208,800	1.2	UL/CUL/TUV/CE	194845CD	75.95	55.49	48.99
	Mean Well	SP75-24	+24V@0-3.2A	76.8W	85-264@47-63	✓	see diagram	see diagram	2.16	100	0.5	0.5	40	3,000	2.0	60	20	10-500Hz; 2G	10	80	208,800	1.2	UL/CUL/TUV/CE	194853CD	75.95	55.49	48.99
	Mean Well	SP75-48	+48V@0-1.6A	76.8W	85-264@47-63	✓	see diagram	see diagram	2.16	100	0.5	0.5	40	3,000	2.0	60	20	10-500Hz; 2G	10	80	208,800	1.2	UL/CUL/TUV/CE	216805CD	75.95	55.49	48.99

* Primary Output

Limited Supply – Special Offers – 90-Day Warranty																											
	Manufacturer	Manufacturer Product Number	Output		Input (VAC @ Hz)	PFC	Size Inches (LxWxH)	Mounting Holes Inches (LxWxDia.)	Power Density (W/in ³)	Ripple & Noise (mV p-p)*	Load Reg. (±%)*	Line Reg. (±%)*	Inrush Curr. (A@120VAC)	Isolation Voltage (VAC)	Leakage Current (mA@240V)	Rise Time (ms)	Hold-up Time (ms)	Vibration	Voltage Adjustment (%)*	Efficiency (%)	MTBF (hours)	Weight (lbs.)	Certification	Jameco Part No.	Price		
			Voltage@Current (min-max)	Power																					1	10	25
Open Frame	Artesyn	NLP70-9693	+3.3@10.5A; +5V@10.5A; +12V@0.65A	70.0W	100-240@50-60	✓	5.5x3.0x1.3	4.6x2.6x0.16	3.26	—	2.0	2.0	17	3,000	0.7	—	16	5-500Hz; 2.4G	—	70	150,000	0.8	UL/CSA/VDE/CE	182916CD	\$3.95	\$3.55	\$3.25
	Delta	DPS-60MPB	+3.3V@0.8-8A; +5V@1-9A; +12V@0-1A; -12V@0-0.2A	65.0W	90-270@47-63	—	5.8x3.3x1.4	—	2.24	50	2.0	2.0	40	—	2.0	100	16	—	—	65	—	1.0	UL/CUL/TUV	171731CD	7.95	6.79	5.09
	Autec	UPS61-1004-T	+3.3V@4A; +5V@2A; +12V@3A; +32V@0.5A	65.0W	115/230@50-60	—	5.0x3.5x1.8	—	1.90	—	—	—	—	—	—	—	—	—	—	—	—	0.8	CSA/CE	189966CD	\$4.95	3.69	3.29
Enclosed	ETA	WRC48SX-U	+48V@1.6A	75.0W	85-264@47-440	—	6.9x3.7x1.5	—	1.95	480	0.9	0.8	20	3,000	—	800	15	10-50Hz; 2G	10	85	—	1.4	UL/CSA/VDE/CE	203529CD	24.95	22.49	22.49
	Volgen	ESK70U-0524WA	+5V@2.5A; +24V@2.5A	72.5W	115/220@50-60	—	8.7x3.9x1.5	—	1.42	—	—	—	—	—	—	—	—	—	—	—	—	1.3	—	205989CD	24.95	22.49	20.25
	Volgen	PRK70U-1515	+5V@5A; +15V@2A; -15V@1A	70.0W	100/120@50-60	—	8.7x4.1x2.8	6.9x3.4x0.08	0.70	80	0.8	0.4	35	1,500	0.5	100	20	10-55Hz; 20G	5	73	—	1.0	UL/CSA	205698CD	24.95	22.49	20.25
	Volgen	ESK80U-1515	+5V@10A; +15V@0.8A; -15V@0.8A	74.0W	115/220@50-60	—	8.7x5.0x1.5	—	1.13	—	—	—	—	—	—	—	—	—	—	—	—	1.9	UL/CSA	205840CD	24.95	22.49	20.25
	Volgen	JRK-115B	+5V@4.5A; +15V@3.5A; +24V@0.4A; -5V@1.6A; -15V@1.5A	75.0W	100/240@50-60	—	10.5x5.0x2.5	—	0.36	—	—	—	—	—	—	—	—	—	—	—	—	2.4	—	205858CD	\$4.95	24.95	22.49

* Primary Output

100-Watt Open Frame With Power Factor Correction



New Lower Quantity Prices

- LPP-100 Series: Single Output
• 100% full-load burn-in
• Auto-switch AC input
• No minimum load required
• 3.4 watts/in³
• 105°C output capacitor
• Three-year warranty
• Power Factor Correction
• Mating connectors: P/Ns 215950CD & 215976CD, pg 135
• -10°C to +60°C working temp (see output derating)

Detailed below in blue, one of Mean Well's newest and most modern designs, the open-frame LPP100 series features input Power Factor Correction that meets EN61000-3-2, required in Europe for power supplies 75 watts and above. Couple this with their full range universal input ranges of 85-264VAC and 120-370VDC, and these switchers are ready for use worldwide.



VALUE PRICES & PERFORMANCE

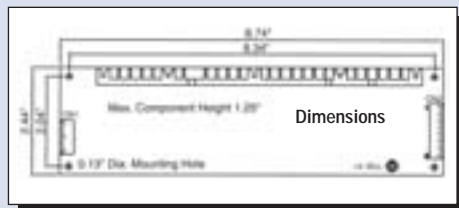
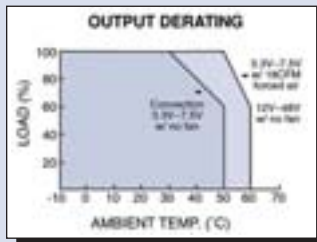

100-Watt Open Frame with Power Factor Correction



- PPQ-1003 & PPQ-100 Series: Quad Outputs
• 100% full-load burn-in
• Auto-switch AC input
• 4.2 watts/in³
• Power Factor Corrected
• 105°C output capacitor
• Three-year warranty
• Mating connectors: PPQ1003-P/Ns 104766CD & two 104432CD, pg 135; PPQ100-P/Ns 104715CD & two 104723CD, pg 135;
• -10°C to +60°C working temp (see output derating)

Shown below in buff color, for applications requiring 3.3VDC and a total of four outputs, these series offer excellent performance, high reliability and surprisingly low cost.



SALE

New Lower Quantity Prices



VALUE PRICES & PERFORMANCE

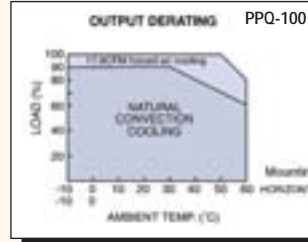
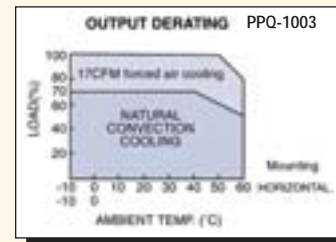

100-Watt Enclosed With Power Factor Correction



- SP-100, TP-100 & QP-100 Series: Single, Triple & Quad Outputs
• 100% full-load burn-in
• Universal AC input
• 2.0 watts/in³
• Power Factor Correction
• 105°C output capacitor
• Three-year warranty
• Mating connectors: 103587CD, pg 123
• -10°C to +60°C working temp. (see output derating)
• For mounting accessories see page 224

Highlighted below in tan, this Mean Well family of 100-watt enclosed switchers feature input Power Factor Correction of 0.98 at 115VAC that complies with EN61000-3-2, required in Europe for power supplies 75 watts and above.

VALUE PRICES & PERFORMANCE



New Lower Quantity Prices

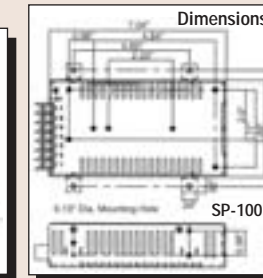
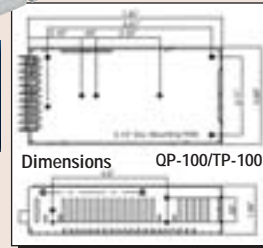
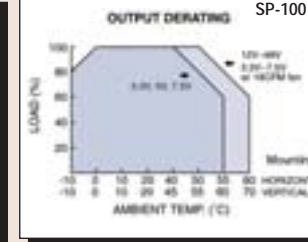
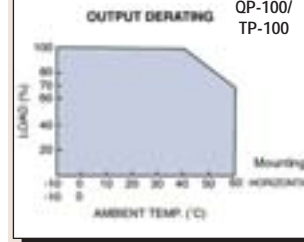

Table with 27 columns: Manufacturer, Product Number, Output (Voltage@Current), Power, Input (VAC @ Hz), PFC, Size Inches (LxWxH), Mounting Holes Inches (LxWxDia.), Power Density (W/in³), Ripple & Noise (mV p-p)*, Load Reg. (±%)*, Line Reg. (±%)*, Inrush Curr. (A@120VAC), Isolation Voltage (VAC), Leakage Current (mA@240V), Rise Time (ms), Hold-up Time (ms), Vibration, Voltage Adjustment (%)*, Efficiency (%), MTBF (hours), Weight (lbs.), Certification, Jameco Part No., and Price (1, 10, 25). Rows include LPP-100, PPQ-100, SP-100, TP-100, and QP-100 series.



110-Watt Open Frame

NFS110-76 Series: Single & Quad Outputs

- 100% full-load burn-in
- Universal AC input
- 110W with 20 CFM of air
- 2.1 watts/in³
- 1U Package: 7" x 4.25" x 1.8"
- Two-year warranty
- Mating connectors: P/Ns 104723CD, 104766CD & 104432CD, pg 135
- 0°C to +70°C working temp. (see output derating)

Detailed below in blue, the Artesyn NFS110 series are 110 watt universal-input power supplies on a 7" x 4.25" x 1.8" card. The NFS110-76 models have proven to be highly reliable and versatile for a wide range of communication and industrial applications, with a very high peak current capability on each output for drive and motor applications. The NFS110-76 series is popular in low power data networking, computer, telecom and industrial applications such as servers, thermal printers, storage devices, vending machines and POS equipment.

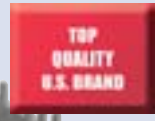

110-Watt Open Frame With Power Factor Correction

NLP110 Series: Single & Triple Outputs

- 100% full-load burn-in
- Universal AC input
- Power Factor Corrected
- 4.4 watts/in³
- 105°C output capacitor
- Two-year warranty
- 1U package: 6.5" x 3" x 1.3"
- 110W with 20 CFM of air
- Mating connectors: P/Ns 104432CD & 2 ea. 104731CD, pg 135
- 0°C to +70°C working temp. (see output derating)

Shown below in buff color, the Artesyn NLP110 series is Power Factor Corrected to meet EN61000-3-2. The multiple output models can deliver equal amounts of current on multiple low voltage outputs to support designs that still span the industry transition from 5-volt to 3.3-volt logic. The NLP110's high power density results in a package only 1.5" longer than the 65-watt Artesyn NLP-65. The NLP110 series, with full international safety approvals, and the CE mark, meets conducted and radiated emissions EN55022 and complies to EN61000-4-2/3/4/5/6 immunity standards. The NLP110 is primarily designed for networking applications in 1U shelves or boxes that have a heavy logic content such as access concentrators, midrange routers, LAN switchers and shared media hubs.

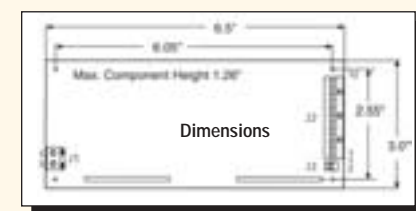
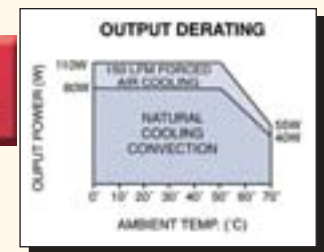

120-Watt Enclosed

D-120 & Q-120 Series: Dual & Quad Outputs

- 100% full-load burn-in
- 1.8 watts/in³
- 105°C output capacitor
- Two-year warranty
- Mating connectors: 103587CD, pg 123
- -10°C to +60°C working temp. (see output derating)
- For mounting accessories see page 224

Highlighted below in tan, the workhorse D-120 and Q-120 have long been amongst the most popular Mean Well series of enclosed switching power supplies. Their efficiency and low working temperature contribute to their very high MTBF of 272,000 hours. Full 120 watts of power is available over the ambient temperature range of 0°C to 50°C. With derating (see below) the range extends to -10°C to 60°C. The solid, reliable, low-cost design features overload protection to 135% of rated load with auto-recovery, and over-voltage protection to 135% of rated output voltage. Additional protection includes short-circuit and a soft-start circuit that limits the AC surge current to a safe value.

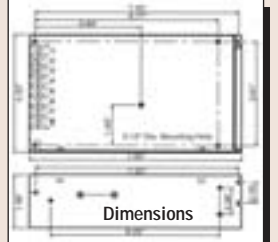
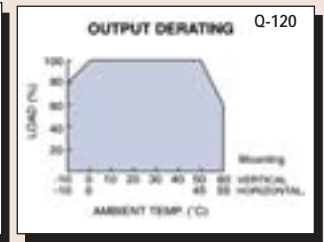
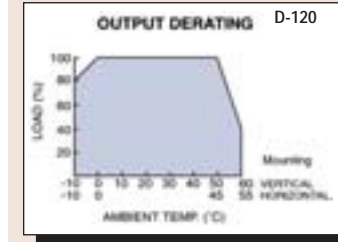

Manufacturer	Product Number	Output		Input (VAC @ Hz)	PFC	Size Inches (LxWxH)	Mounting Holes (LxWxDia.)	Power Density (W/in ³)	Ripple & Noise (mV p-p)*	Load Reg. (±%)*	Line Reg. (±%)*	Inrush Curr. (A@120VAC)	Isolation Voltage (VAC)	Leakage Current (mA@240V)	Rise Time (ms)	Hold-up Time (ms)	Vibration	Voltage Adjustment (%)*	Efficiency (%)	MTBF (hours)	Weight (lbs.)	Certification	Jameco Part No.	Price		
		Voltage@Current (min-max)	Power																					1	10	25
Artesyn	NFS110-7612	+12V@0-7A	84.0W	85-264@47-440	—	7.0x4.25x1.8	6.6x3.75x0.16	1.67	120	2.0	0.1	35	3,000	0.2	—	17	5-500Hz; 2.4G	3	72	125,000	1.2	UL/CUL/CSA/VDE/CE	218982CD	\$111.95	\$100.79	\$90.69
Artesyn	NFS110-7624	+24V@0-3.5A	84.0W	85-264@47-440	—	7.0x4.25x1.8	6.6x3.75x0.16	1.67	240	2.0	0.1	35	3,000	0.2	—	17	5-500Hz; 2.4G	3	75	125,000	1.2	UL/CUL/CSA/VDE/CE	218974CD	111.95	100.79	90.69
Artesyn	NFS110-7602P	+5.1V@0-8A; +12V@0-4.5A; -5V@0-0.5A; -12V@0-0.5A	103.3W	85-264@47-440	—	7.0x4.25x1.8	6.6x3.75x0.16	2.60	50	2.0	0.1	35	3,000	0.2	—	17	5-500Hz; 2.4G	3	70	125,000	1.3	UL/CUL/CSA/VDE/CE	218966CD	111.95	100.79	90.69
Artesyn	NFS110-7604	+5.1V@0-8A; +15V@0-4A; -5V@0-0.5A; -15V@0-0.5A	110.6W	85-264@47-440	—	7.0x4.25x1.8	6.6x3.75x0.16	2.78	50	2.0	0.1	35	3,000	0.2	—	17	5-500Hz; 2.4G	3	70	125,000	1.3	UL/CUL/CSA/VDE/CE	220231CD	115.95	104.39	93.95
Artesyn	NLP110-9605	+5V@0.5-15A	75.0W	90-264@47-63	✓	6.5x3.0x1.26	6.05x2.55x—	2.96	50	2.0	2.0	18	3,000	0.45	1000	16.7	5-500Hz; 2.4G	3	75	220,000	0.6	UL/CUL/CSA/VDE	218915CD	107.65	96.65	90.95
Artesyn	NLP110-9612	+12V@0.3-6.4A	76.8W	90-264@47-63	✓	6.5x3.0x1.26	6.05x2.55x—	3.03	120	2.0	2.0	18	3,000	0.45	1000	16.7	5-500Hz; 2.4G	3	75	220,000	0.6	UL/CUL/CSA/VDE	218923CD	107.65	96.65	90.95
Artesyn	NLP110-9624	+24V@0.2-3.2A	76.8W	90-264@47-63	✓	6.5x3.0x1.26	6.05x2.55x—	3.03	240	2.0	2.0	18	3,000	0.45	1000	16.7	5-500Hz; 2.4G	3	75	220,000	0.6	UL/CUL/CSA/VDE	218931CD	107.65	96.65	90.95
Artesyn	NLP110-9693	+3.3V@0.2-13A; +5V@0.5-13A; +12V@0-0.65A	110.0W	90-264@47-63	✓	6.5x3.0x1.26	6.05x2.55x—	4.56	50	2.0	2.0	18	3,000	0.45	1000	16.7	5-500Hz; 2.4G	3	75	220,000	0.6	UL/CUL/CSA/VDE	218940CD	107.65	96.65	90.95
Artesyn	NLP110-9608	+5V@0.2-13A; +12V@0.2-6.5A; -12V@0-0.65A	110.0W	90-264@47-63	✓	6.5x3.0x1.26	6.05x2.55x—	5.95	120	2.0	2.0	18	3,000	0.45	1000	16.7	5-500Hz; 2.4G	3	75	220,000	0.6	UL/CUL/CSA/VDE	218958CD	107.65	96.65	90.95
Mean Well	D-120A	+5V@2-12A; +12V@0.5-5A	120.0W	88-132/176-264@47-63	—	see diagram	see diagram	1.79	60	0.5	0.5	35	3,000	3.5	50	20	10-500Hz; 2G	10	78	272,000	1.9	UL/CUL/TUV/CE	132409CD	76.95	52.99	46.99
Mean Well	D-120B	+5V@2-6A; +24V@0.4-4A	126.0W	88-132/176-264@47-63	—	see diagram	see diagram	1.88	60	0.5	0.5	35	3,000	3.5	50	20	10-500Hz; 2G	10	80	272,000	1.9	UL/CUL/TUV/CE	132396CD	76.95	52.99	46.99
Mean Well	Q-120B	+5V@2-11A; +12V@0.2-1A; 12V@0.5-4A; -12V@0.2-1A	120.0W	88-132/176-264@47-63	—	see diagram	see diagram	1.79	80	0.5	0.5	35	3,000	3.5	50	20	10-500Hz; 2G	10	77	261,000	1.9	UL/CUL/TUV/CE	132388CD	82.95	57.99	50.99
Mean Well	Q-120D	+5V@2-8A; +24V@0.2-2A; +12V@0.2-2A; -12V@0.2-1A	124.0W	88-132/176-264@47-63	—	see diagram	see diagram	1.85	80	0.5	0.5	35	3,000	3.5	50	20	10-500Hz; 2G	10	80	261,000	1.9	UL/CUL/TUV/CE	132370CD	82.95	57.99	50.99



* Primary Output



Limited Supply – Special Offers – 90-Day Warranty

Manufacturer	Product Number	Output		Input (VAC @ Hz)	PFC	Size Inches (LxWxH)	Mounting Holes (LxWxDia.)	Power Density (W/in ³)	Ripple & Noise (mV p-p)*	Load Reg. (±%)*	Line Reg. (±%)*	Inrush Curr. (A@120VAC)	Isolation Voltage (VAC)	Leakage Current (mA@240V)	Rise Time (ms)	Hold-up Time (ms)	Vibration	Voltage Adjustment (%)*	Efficiency (%)	MTBF (hours)	Weight (lbs.)	Certification	Jameco Part No.	Price		
		Voltage@Current (min-max)	Power																					1	10	25
Astec	AA20140	+5V@1-20A; +12V@0.2-2A	120.0W	100-240@50-60	✓	7.0x4.2x1.5	6.5x3.8x0.17	2.72	50	—	—	40	—	2.0	—	15	32-2kHz; 1G	5	65	200,000	1.1	UL/CSA/VDE	190422CD	\$6.39	\$5.85	\$5.29
Power-One	MAP110-4300	+3.3V@15A; +5V@8A; +12V@1A; -12V@1A	110.0W	85-264@47-63	—	7.0x4.3x2.0	6.5x2.8x0.17	1.83	30	0.7	0.3	41	2,600	0.75	20	—	—	10	75	134,000	1.6	UL/CSA/TUV/CE	211297CD	29.95	26.95	24.25
Power-One	MAP110-4000P	+5V@12A; +12V@5A; -5V@1A; -12V@1A	110.0W	85-264@47-63	—	7.0x4.3x1.9	6.5x3.8x0.17	1.92	50	0.5	0.2	41	2,600	0.75	20	20	—	—	75	134,000	1.6	UL/CSA/TUV/CE	202868CD	29.95	26.99	24.29
IPD Power	SRW-115-4001	+5V@12A; +12V@4A; -5V@4A; -12V@2A	115.0W	85-264@47-63	—	7.0x4.3x1.2	6.0x3.8x0.16	3.18	—	1.0	—	40	4,250	—	1000	16	—	10	72	150,000	1.3	UL/CUL/TUV/CE	204505CD	29.95	25.49	19.09
IPD Power	SRW-115-4001-48	+5V@15A; +12V@1A; -5V@3A; -48V@1A	115.0W	85-264@47-63	—	7.0x4.3x1.2	6.0x3.8x0.16	3.18	—	1.0	—	40	4,250	—	1000	16	—	10	72	150,000	1.3	UL/CUL/TUV/CE	204450CD	29.95	26.99	24.29
Volgen	EXU-482R2	+48V@2.2A	105.0W	100/120@50-60	—	6.9x3.7x1.8	4.6x3.2x0.12	2.28	—	0.8	0.4	30	2,000	0.5	200	—	10-55Hz; 20G	10	86	—	0.6	UL	205786CD	31.95	28.79	25.89

* Primary Output



Limited Supply – Special Offers – 90-Day Warranty





200-Watt Enclosed With Power Factor Correction



SP-200 Series: Single Output

- 100% full-load burn-in
- Universal AC input
- No minimum load required
- Power Factor Correction
- Three-year warranty
- 105°C output capacitor
- 3.3 watts/in³
- Built-in fan cooling
- Mating connectors: P/Ns 103587CD, pg 123
- -10° to +60°C working temperature (see output derating)
- For mounting accessories see page 224



New Lower Quantity Prices

VALUE PRICES & PERFORMANCE



Highlighted below in blue, this advanced switcher line is part of Mean Well's family of premium power supplies that carry an unusually long three-year warranty. Their performance, reliability and low cost result from a modern state-of-the-art design using highly integrated components. The SP-200 offers input Power Factor Correction that meets EN61000-3-2, required in Europe for power supplies 75 watts and above. Assured to operate correctly anywhere in the world, these open-frame switchers feature universal voltage input ranges of 85-264VAC and 120-370VDC. The built-in cooling fan operates automatically from both thermal and load-based sensors. These products are approved by UL, CUL, and TUV; and carry the CE mark, for use worldwide. The EMC standards met are EN55022 Class B and EN61000-4-2/3/4/5/6/8/11.

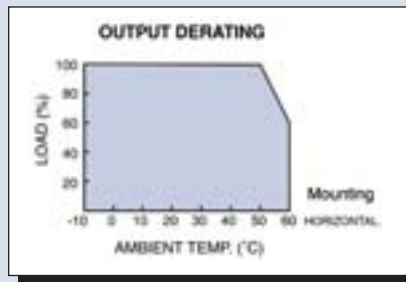
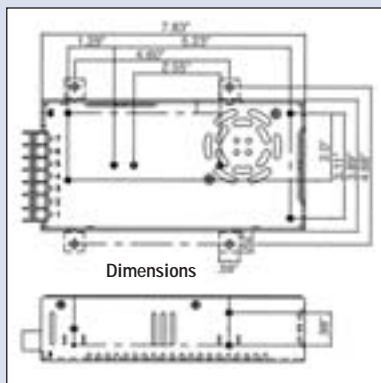

UNDERSTANDING POWER SUPPLIES #14
RADIATED EMI: Also called radio-frequency interference (RFI), EMI is unwanted high-frequency energy caused by the switching transistors, output rectifiers, and zener diodes in switching power supplies. That portion that is radiated through space is known as Radiated EMI. Most radiated EMI measurements are done between 30MHz and 300MHz.

200-Watt Enclosed With Power Factor Correction



QP-200 Series: Quad Output

- 100% full-load burn-in
- Remote sense
- 105°C output capacitor
- Built-in fan cooling
- Mating connectors: P/Ns 103587CD, pg 123
- -10° to +60°C working temperature (see output derating)
- For mounting accessories see page 224
- Universal AC input
- Power Factor Correction
- Three-year warranty
- 3.3 watts/in³



New Lower Quantity Prices

VALUE PRICES & PERFORMANCE



Shown below in buff color, the Mean Well QP-200 quad-output, enclosed switcher features remote sensing for precise point-of-load voltage control on V1 and V2, and full isolation on V4. The built-in cooling fan assures safe operation at full power output over the ambient temperature range of -10°C to 50°C, with derating to 60°C (see below). The impressive performance, reliability and low-cost of the QP-200 series results from a modern state-of-the-art design using highly integrated components. It offers input Power Factor Correction that meets EN61000-3-2, required in Europe for power supplies 75 watts and above. Assured to operate correctly anywhere in the world, these open-frame switchers feature universal voltage input ranges of 90-264VAC and 127-370VDC. These products are approved by UL, CUL, and TUV; and carry the CE mark, for worldwide use. The QP-200 series meets EMC standards EN55022 Class B and EN61000-4-2/3/4/5/6/8/11.

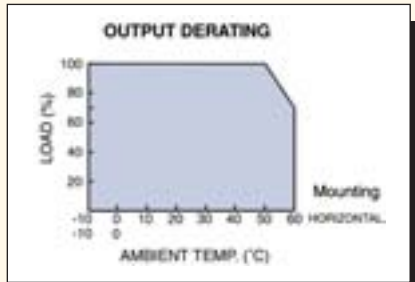
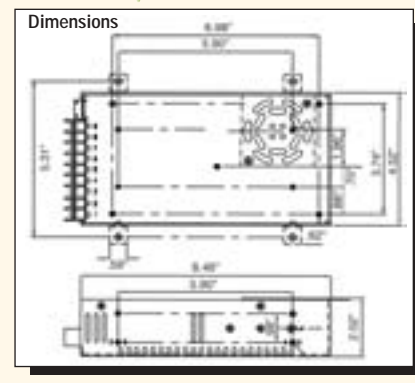

UNDERSTANDING POWER SUPPLIES #15
REMOTE SENSING: A technique of regulating the output voltage of a power supply at the load by means of high-impedance, low-current sensing leads which go from the load back to the regulator. This compensates for voltage drops in the load leads.

240-Watt Enclosed



S-240 Series: Single Output

- 100% full-load burn-in
- No minimum load required
- 105°C output capacitor
- Auto cooling fan
- Two-year warranty
- Mating connectors: 103587CD, pg 123
- -10°C to +60°C working temp. (see output derating)
- For mounting accessories see page 224
- Auto-switch AC input
- 3.3 watts/in³



VALUE PRICES & PERFORMANCE



Highlighted below in tan, with a built-in cooling fan that operates from an automatic thermal switch, the workhorse Mean Well S-240 produces 240 watts of power from 0°C to 50°C, and is derated to -10°C and 60°C (see below). The input features an auto-sensing circuit that switches between 88-132VAC and 176-264VAC. The impressive reliability derives from a conservative design, the exclusive use of high-quality components, and 100% full-load burn-in. Protection includes short-circuit, overload and over-voltage. A novel soft-start circuit limits the AC surge current. Guaranteed safety standards comprise UL1950 and TUV EN60950, and these products carry the European CE mark. The DC output voltage can be adjusted ±10% of nominal rating.

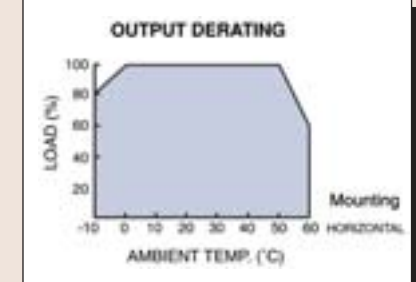
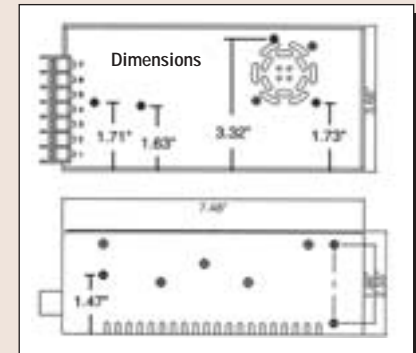

UNDERSTANDING POWER SUPPLIES #16
OUTPUT CURRENT LIMITING: An output protection feature which limits the output current to a predetermined value in order to prevent damage to the power supply or the load under overload conditions. The supply is automatically restored to normal operation following removal of the overload.

Manufacturer	Product Number	Output		Input (VAC @ Hz)	PFC	Size Inches (LxWxH)	Mounting Holes Inches (LxWxDia.)	Power Density (W/in ³)	Ripple & Noise (mV p-p)*	Load Reg. (±%)*	Line Reg. (±%)*	Inrush Curr. (A@120VAC)	Isolation Voltage (VAC)	Leakage Current (mA@240V)	Rise Time (ms)	Hold-up Time (ms)	Vibration	Voltage Adjustment (%)*	Efficiency (%)	MTBF (hours)	Weight (lbs.)	Certification	Jameco Number	Price		
		Voltage@Current (min-max)	Power																					1	10	25
Mean Well	SP-200-3.3	+3.3V@0-40A	132.0W	85-264@47-63	✓	see diagram	see diagram	2.17	100	1.0	0.5	40	3,000	2.0	30	20	10-500Hz: 2G	10	65	183,000	1.9	UL/CUL/TUV/CE	212417CD	\$109.95	\$77.99	\$67.99
Mean Well	SP-200-5	+5V@0-40A	200.0W	85-264@47-63	✓	see diagram	see diagram	3.29	100	1.0	0.5	40	3,000	2.0	30	20	10-500Hz: 2G	10	71	183,000	1.9	UL/CUL/TUV/CE	202041CD	109.95	77.99	67.99
Mean Well	SP-200-12	+12V@0-16.7A	200.4W	85-264@47-63	✓	see diagram	see diagram	3.29	100	0.5	0.5	40	3,000	2.0	30	20	10-500Hz: 2G	10	79	183,000	1.9	UL/CUL/TUV/CE	194773CD	109.95	77.99	67.99
Mean Well	SP-200-13.5	+13.5V@0-14.9A	201.1W	85-264@47-63	✓	see diagram	see diagram	3.31	100	0.5	0.5	40	3,000	2.0	30	20	10-500Hz: 2G	10	80	183,000	1.9	UL/CUL/TUV/CE	212409CD	109.95	77.99	67.99
Mean Well	SP-200-15	+15V@0-13.4A	201.0W	85-264@47-63	✓	see diagram	see diagram	3.30	100	0.5	0.5	40	3,000	2.0	30	20	10-500Hz: 2G	10	81	183,000	1.9	UL/CUL/TUV/CE	202059CD	109.95	77.99	67.99
Mean Well	SP-200-24	+24V@0-8.4A	201.6W	85-264@47-63	✓	see diagram	see diagram	3.31	150	0.5	0.5	40	3,000	2.0	30	20	10-500Hz: 2G	10	83	183,000	1.9	UL/CUL/TUV/CE	194781CD	109.95	77.99	67.99
Mean Well	SP-200-48	+48V@0-4.2A	201.6W	85-264@47-63	✓	see diagram	see diagram	3.31	250	0.5	0.5	40	3,000	2.0	30	20	10-500Hz: 2G	10	84	183,000	1.9	UL/CUL/TUV/CE	202067CD	109.95	77.99	67.99
Mean Well	QP-200-3B	+3.3V@0-15A; +5V@3-15A; +12V@0.5-6A; -12V@0-0.7A	204.9W	90-264@47-63	✓	see diagram	see diagram	2.50	100	2.0	1.0	45	3,000	2.0	50	16	10-500Hz: 2G	10	72	160,600	2.4	UL/CUL/TUV/CE	213743CD	156.95	127.99	112.99
Mean Well	QP-200-3D	+3.3V@0-15A; +5V@3-10A; +24V@0.4-4A; -12V@0-0.7A	203.9W	90-264@47-63	✓	see diagram	see diagram	2.49	100	2.0	1.0	45	3,000	2.0	50	16	10-500Hz: 2G	10	74	160,600	2.4	UL/CUL/TUV/CE	213735CD	156.95	127.99	112.99
Mean Well	QP-200D	+5V@3-15A; +12V@0-4A; +24V@0.4-3A; -12V@0-0.7A	203.4W	90-264@47-63	✓	see diagram	see diagram	2.40	100	2.0	1.0	45	3,000	2.0	50	16	10-500Hz: 2G	10	75	160,600	2.4	UL/CUL/TUV/CE	213751CD	156.95	127.99	112.99
Mean Well	S-240-5	+5V@0-40A	200.0W	88-132/176-264@47-63	—	see diagram	see diagram	2.60	150	1.0	0.5	18	3,000	1.2	20	20	10-500Hz: 2G	10	78	179,000	2.5	UL/CUL/TUV/CE	202083CD	103.95	91.99	80.99
Mean Well	S-240-12	+12V@0-18A	216.0W	88-132/176-264@47-63	—	see diagram	see diagram	2.81	150	0.5	0.5	18	3,000	1.2	20	20	10-500Hz: 2G	10	82	179,000	2.5	UL/CUL/TUV/CE	137648CD	103.95	91.99	80.99
Mean Well	S-240-15	+15V@0-15A	225.0W	88-132/176-264@47-63	—	see diagram	see diagram	2.92	150	0.5	0.5	18	3,000	1.2	20	20	10-500Hz: 2G	10	83	179,000	2.5	UL/CUL/TUV/CE	202075CD	103.95	91.99	80.99
Mean Well	S-240-24	+24V@0-10A	240.0W	88-132/176-264@47-63	—	see diagram	see diagram	3.12	180	0.5	0.5	18	3,000	1.2	20	20	10-500Hz: 2G	10	84	179,000	2.5	UL/CUL/TUV/CE	137656CD	103.95	91.99	80.99
Mean Well	S-240-48	+48V@0-5A	240.0W	88-132/176-264@47-63	—	see diagram	see diagram	3.12	240	1.0	1.0	18	3,000	1.2	20	20	10-500Hz: 2G	10	87	179,000	2.5	UL/CUL/TUV/CE	167337CD	103.95	91.99	80.99

* Primary Output

500-Watt Enclosed
With Power Factor Correction
SP-500 Series: Single Output

- 100% full-load burn-in
- No minimum load required
- Power Factor Correction
- 105°C output capacitor
- Remote control
- Mating connectors: P/Ns 103587CD pg 123
- -10° to +60°C working temp. (see output derating)
- Universal AC input
- 3.6 watts/in³
- Auto cooling fan
- Three-year warranty

Detailed below in blue, this advanced switcher line is part of Mean Well's family of premium power supplies that carry an unusually long three-year manufacturers warranty. Their performance, reliability and low cost result from a modern state-of-the-art design using highly integrated components. The SP-500 offers input Power Factor Correction of 0.98 at 115VAC that meets EN61000-3-2, required in Europe for power supplies 75 watts and above. Assured to operate correctly anywhere in the world, these enclosed switchers feature universal voltage input ranges of 88-264VAC and 124-370VDC. The SP-500 is cooled with an automatic internal fan. These products are approved by UL, CUL, and TUV; and carry the CE mark, for use worldwide. EMC standards met are EN55022 Class B and EN61000-4-2/3/4/5/6/8/11.

UNDERSTANDING POWER SUPPLIES #17
PARALLEL OPERATION (CURRENT SHARING):
The connection of the outputs of two or more power supplies of the same output voltage to obtain a higher output current than from either supply alone. This requires power supplies specifically designed to share the load.

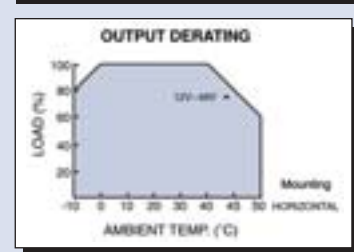
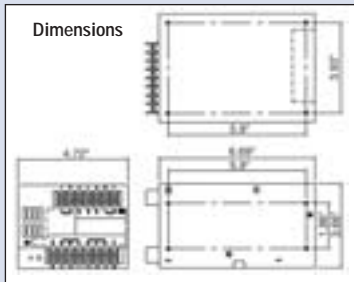

500 & 1000-Watt Enclosed
With Power Factor Correction
& Current Sharing
PSP-500 & PSP-1000 Series: Single Output

- 100% full-load burn-in
- No minimum load required
- 105°C output capacitor
- Parallel operation (current sharing)
- Remote sense and control
- Power Factor Correction
- Mating connectors: P/Ns 103587CD, pg 123
- -10° to +60°C working temp. (see output derating for PSP-500; for PSP-1000 see www.Jameco.com)
- Universal AC input
- 3.6 watts/in³
- Three-year warranty
- Auto cooling fan

Highlighted below in buff color, these families of feature rich, high-quality, low-cost switchers provide parallel operation to 2000 watts, Power Factor Correction of 0.98 at 115VAC that complies with EN61000-3-2, remote sensing for precise point-of-load voltage control, and ON-OFF remote control. Greater versatility results from availability of a "power good/fail signal". Cooling is provided by an integral forced air fan (two in the PSP-1000) that assures safe operation at full power output over the ambient temperature range of 0°C to 50°C, with derating -10°C and 60°C at 80% of load. Protection includes short-circuit, overload over-voltage; and a novel soft-start circuit limits the AC surge current. Guaranteed safety standards comprise UL1950 and TUV EN60950, and they carry the European CE mark. The PSP-500 and the PSP-1000 series meet EMC standards EN55022 Class B and EN61000-4-2/3/4/5/6/8/11.

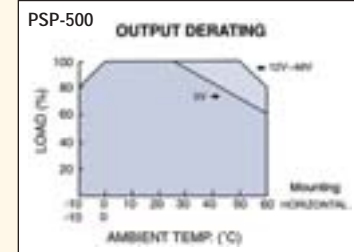
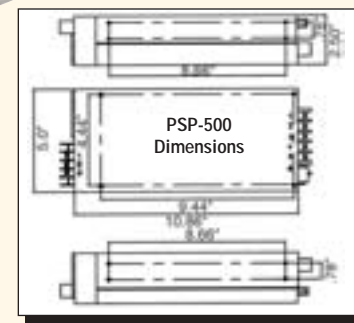

600-Watt Enclosed With Current Sharing
SCN-600 Series: Single Output

- 100% full-load burn-in
- Auto cooling fan
- No minimum load required
- 4.2 watts/in³
- 105°C output capacitor
- Two-year warranty
- Parallel operation (current sharing)
- Remote sense and control
- Mating connectors: P/Ns 103587CD, pg 123
- -10° to +65°C working temperature; (+50° to -65°C @ 50% load)
- For mounting accessories see page 224

Shown below in tan, the SCN-600 family of 600-watt enclosed switchers offer advanced N+1 parallel operation, remote sensing for precise point-of-load voltage control and built-in remote ON-OFF control. Also, a unique capability allows output voltage adjustment from 10-100% of rated value with an external 1-5VDC signal. The input can be switch selected for voltage ranges of 100-130VAC and 200-260VAC. The DC output voltage can be adjusted ±5% of nominal rating. The solid, reliable, low-cost design features overload protection to 135% of rated load with auto-recovery, and over-voltage protection to 145% of rated output voltage. Additional protection includes short-circuit and a soft-start circuit that limits the AC surge current to a safe value. Meeting the requirements of UL1950 and TUV EN60950, these products are approved by UL, CUL and TUV; and carry the CE mark.

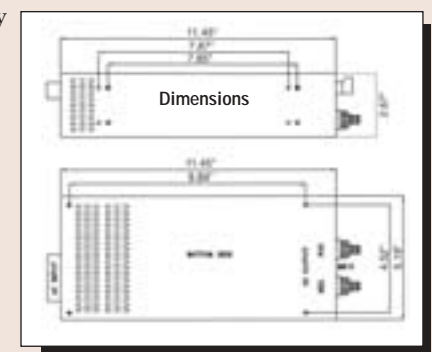

Manufacturer	Manufacturer Product Number	Output		Input (VAC @ Hz)	PFC	Size Inches (LxWxH)	Mounting Holes Inches (LxWxDia.)	Power Density (W/in ³)	Ripple & Noise (mV p-p)*	Load Reg. (±%)*	Line Reg. (±%)*	Inrush Curr. (A@ 120VAC)	Isolation Voltage (VAC)	Leakage Current (mA@240V)	Rise Time (ms)	Hold-up Time (ms)	Vibration	Voltage Adjustment (%)*	Efficiency (%)	MTBF (hours)	Weight (lbs.)	Certification	Jameco Number	Price		
		Voltage@Current (min-max)	Power																					1	10	25
Mean Well	SP500-12	+12V@0-40A	480.0W	100-240@50-60	✓	see diagram	see diagram	3.60	240	0.5	0.5	18	3,000	3.5	50	20	10-500Hz; 2G	10	84	133,000	4.2	UL/CUL/TUV/CE	190692CD	\$259.95	\$173.99	\$152.99
Mean Well	SP500-13.5	+13.5V@0-36A	486.0W	100-240@50-60	✓	see diagram	see diagram	3.65	240	0.5	0.5	18	3,000	3.5	50	20	10-500Hz; 2G	10	84	133,000	4.2	UL/CUL/TUV/CE	212388CD	259.95	173.99	152.99
Mean Well	SP500-15	+15V@0-32A	480.0W	100-240@50-60	✓	see diagram	see diagram	3.60	240	0.5	0.5	18	3,000	3.5	50	20	10-500Hz; 2G	10	83	133,000	4.2	UL/CUL/TUV/CE	213604CD	259.95	173.99	152.99
Mean Well	SP500-24	+24V@0-20A	480.0W	100-240@50-60	✓	see diagram	see diagram	3.60	240	0.5	0.5	18	3,000	3.5	50	20	10-500Hz; 2G	10	85.5	133,000	4.2	UL/CUL/TUV/CE	147053CD	259.95	173.99	152.99
Mean Well	SP500-27	+27V@0-18A	486.0W	100-240@50-60	✓	see diagram	see diagram	3.65	200	0.5	0.5	18	3,000	3.5	50	20	10-500Hz; 2G	10	86.5	133,000	4.2	UL/CUL/TUV/CE	190705CD	259.95	173.99	152.99
Mean Well	SP500-48	+48V@0-10A	480.0W	100-240@50-60	✓	see diagram	see diagram	3.60	300	0.5	0.5	18	3,000	3.5	50	20	10-500Hz; 2G	10	87	133,000	4.2	UL/CUL/TUV/CE	161795CD	259.95	173.99	152.99
Mean Well	PSP-500-5	+5V@0-80A	400.0W	90-264@47-63	✓	see diagram	see diagram	2.91	100	2.0	0.5	20	3,000	1.0	50	15	10-500Hz; 2G	10	76	130,100	5.5	UL/CUL/TUV/CE	202112CD	261.95	210.99	196.99
Mean Well	PSP-500-12	+12V@0-41.5A	498.0W	90-264@47-63	✓	see diagram	see diagram	3.62	150	0.5	0.3	20	3,000	1.0	50	15	10-500Hz; 2G	10	82	130,100	5.5	UL/CUL/TUV/CE	190713CD	261.95	210.99	196.99
Mean Well	PSP-500-15	+15V@0-33A	498.0W	90-264@47-63	✓	see diagram	see diagram	3.60	150	0.5	0.3	20	3,000	1.0	50	15	10-500Hz; 2G	10	82	130,100	5.5	UL/CUL/TUV/CE	202121CD	261.95	210.99	196.99
Mean Well	PSP-500-24	+24V@0-20.8A	499.2W	90-264@47-63	✓	see diagram	see diagram	3.63	150	0.5	0.2	20	3,000	1.0	50	15	10-500Hz; 2G	10	84	130,100	5.5	UL/CUL/TUV/CE	190721CD	261.95	210.99	196.99
Mean Well	PSP-500-27	+27V@0-18.5A	499.5W	90-264@47-63	✓	see diagram	see diagram	3.63	150	0.5	0.2	20	3,000	1.0	50	15	10-500Hz; 2G	10	84	130,100	5.5	UL/CUL/TUV/CE	190730CD	261.95	210.99	196.99
Mean Well	PSP-500-48	+48V@0-10.5A	504.0W	90-264@47-63	✓	see diagram	see diagram	3.67	200	0.5	0.2	20	3,000	1.0	50	15	10-500Hz; 2G	10	86	130,100	5.5	UL/CUL/TUV/CE	190748CD	261.95	210.99	196.99
Mean Well	PSP-1000-5	+5V@0-145A	725.0W	90-264@47-63	✓	see www.Jameco.com	see diagram	2.61	100	2.0	0.5	35	3,000	2.0	50	15	10-500Hz; 2G	10	76	—	10.4	UL/CUL/TUV/CE	217373CD	523.95	401.99	365.99
Mean Well	PSP-1000-12	+12V@0-75A	900.0W	90-264@47-63	✓	see www.Jameco.com	see diagram	3.24	150	0.5	0.3	35	3,000	2.0	50	15	10-500Hz; 2G	10	82	—	10.4	UL/CUL/TUV/CE	217365CD	523.95	401.99	365.99
Mean Well	PSP-1000-24	+24V@0-37.6A	902.4W	90-264@47-63	✓	see www.Jameco.com	see diagram	3.25	150	0.5	0.2	35	3,000	2.0	50	15	10-500Hz; 2G	10	84	—	10.4	UL/CUL/TUV/CE	217357CD	523.95	401.99	365.99
Mean Well	PSP-1000-48	+48V@0-19A	912.0W	90-264@47-63	✓	see www.Jameco.com	see diagram	3.28	200	0.5	0.2	35	3,000	2.0	50	15	10-500Hz; 2G	10	86	—	10.4	UL/CUL/TUV/CE	217349CD	523.95	401.99	365.99
Mean Well	SCN-600-05	+5V@0-100A	500.0W	90-130/180-260@47-63	—	see diagram	see diagram	3.10	100	2.0	0.5	60	1,500	3.5	50	16	10-200Hz; 2G	5	77	—	5.7	UL/CUL	220249CD	273.95	213.99	197.99
Mean Well	SCN-600-12	+12V@0-50A	600.0W	90-130/180-260@47-63	—	see diagram	see diagram	3.72	120	1.0	0.5	60	1,500	3.5	50	16	10-200Hz; 2G	5	80	—	5.7	UL/CUL	220257CD	273.95	213.99	197.99
Mean Well	SCN-600-24	+24V@0-25A	600.0W	90-130/180-260@47-63	—	see diagram	see diagram	3.72	240	1.0	0.5	60	1,500	3.5	50	16	10-200Hz; 2G	5	85	—	5.7	UL/CUL	220265CD	273.95	213.99	197.99

Manufacturer	Manufacturer Product Number	Output		Input (VAC @ Hz)	PFC	Size Inches (LxWxH)	Mounting Holes Inches (LxWxDia.)	Power Density (W/in ³)	Ripple & Noise (mV p-p)*	Load Reg. (±%)*	Line Reg. (±%)*	Inrush Curr. (A@ 120VAC)	Isolation Voltage (VAC)	Leakage Current (mA@240V)	Rise Time (ms)	Hold-up Time (ms)	Vibration	Voltage Adjustment (%)*	Efficiency (%)	MTBF (hours)	Weight (lbs.)	Certification	Jameco Number	Price		
		Voltage@Current (min-max)	Power																					1	10	25
Power-One	PFC-500-1024	24V@0.6-21A	500.0W	85-264@47-63	✓	9.0x5.0x2.6	6.6x3.9x0.13	4.27	240	0.2	0.5	35	2,600	2.0	10	20	5-2kHz; 1G	10	75	—	4.4	UL/CSA/TUV/CE	202905CD	\$69.95	\$62.99	\$56.69
Power-One	PFC-500-1048	48V@1.2-10.4A	500.0W	85-264@47-63	✓	9.0x5.0x2.6	6.6x3.9x0.13	4.27	480	0.5	0.5	35	2,600	2.0	10	20	5-2kHz; 1G	10	75	—	3.7	UL/CSA/TUV/CE	202913CD	69.95	62.99	56.69

Just Added! World-Class DC-to-DC Converters

Power



New

Jameco has greatly expanded its DC-to-DC converter line by entering into a distribution agreement with Artesyn Technologies and expanding its breadth of Mean Well converters. Artesyn, a US brand, is a world leader in high-quality power conversion products for systems employing Distributed Power Architectures (DPA). And for value-pricing, Mean Well offers a broad line of high-performance products.



Now you can avoid the hassles of "large company" distribution channels and get immediate delivery of products from some of the world's top power products manufacturers. Be sure to see pages 35-45 for our complete line of DC-to-DC converters.

Power Products from a Name You Trust



Jameco continues to expand its commitment to DC-to-DC converters and switching power supplies. In addition to offering 11 converter product pages, new name brands and great savings, we're providing more of the information you

need to make good technical choices. And if you have on-going needs, be sure to ask for an Inside Sales representative. Your personal sales rep will be familiar with your unique requirements, order after order.



Save More in Larger Quantities!

Looking to save even more? We already guarantee the lowest prices, but you can save even more when you purchase from Jameco in larger quantities! Our Inside Sales reps are available at 1-800-831-4242 to get you the best value on your quantity purchases.



Save with Limited Supply Items

In addition to providing you with products suitable for long-term production runs, Jameco also continues to offer limited-supply products at great savings. We've negotiated great deals for these limited availability supplies, and you can be assured we're passing the savings on to you.

Easily Make Technical Selections from the Catalog

Now as part of our commitment to the expanding DC-to-DC converter line, we have added information to help you make informed technical decisions. You have more in-depth information, including output derating curves and specifications including output ripple, regulation, certifications, and more. Plus,

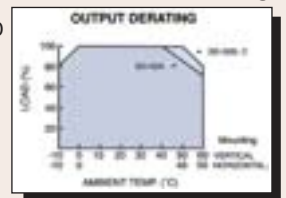

the charts in this catalog allow you to easily compare specifications of multiple manufacturers' products. Need more help deciding? You can always call our toll-free tech support hot-line at 1-800-831-4242. Our senior technicians are available to help solve your power supply challenges.

Not sure of the meaning of a converter term? We've featured numerous explanations throughout the power section offering the definition of the terms used in this catalog and the industry.

Ease of Ordering

Whether you need to buy 1, 10 or 100 products, you'll find ordering is easy at Jameco Electronics. You can call us any time of day or night, 365 days a year at 1-800-831-4242, fax your order to 1-800-237-6948 or place your order online at www.Jameco.com/power. We'll be ready to process your order. And remember, 99% of orders placed before 6 pm EST go out the same day, so you know you'll get your order quicker!

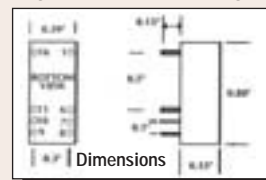

UNDERSTANDING CONVERTERS #1

PI-FILTER: A commonly used filter at the input of a switching supply or DC/DC converter to reduce reflected ripple current. The filter usually consists of two parallel capacitors and a series of inductance and is generally built into supply.

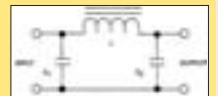

Artesyn 6 to 30-Amp Non-Isolated, Point-of-Load DC-to-DC Converters

6-Amp SIL06C Series



- Ultra-wide trim range
- Horizontal and vertical models
- "Power good" signal
- Protection: over-current & short-circuit
- Working temperature: 0° to +80°C (derated above 50°C)



Highlighted below in blue, the SIL06C series are new high-density, open-frame, non-isolated DC-to-DC converters for space-sensitive applications.

An external resistor adjusts the output voltage from its pre-set value of 0.9V to any value up to the 3.3V maximum. The SIL06C series offers remote ON/OFF and over-current protection as standard. With full international safety approval including EN60950 and UL60950, the SIL06C reduces compliance costs and time to market.

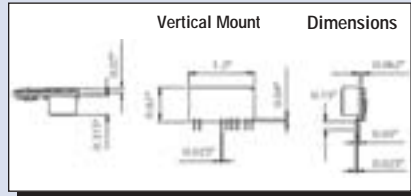
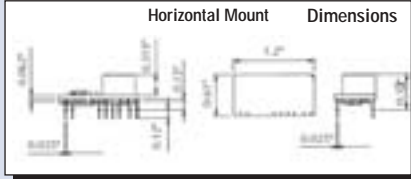

10-Amp SIL10E Series

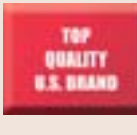

- Highest power density: 107W/in³
- Remote sense
- 96% efficiency at 3.3V
- Protection: thermal & short-circuit
- Working temperature: -40° to +100°C (derated above 70°C)

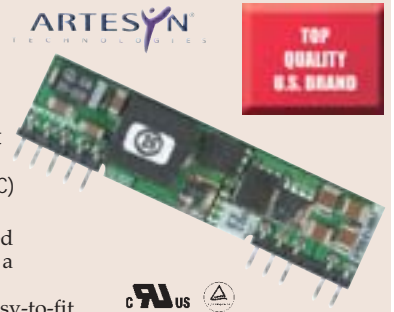

Detailed below in tan, the SIL10E series are non-isolated DC/DC converters packaged in a single-in-line footprint giving designers a cost-effective and easy-to-fit solution for conversion from either a 3.3V or 5V input voltage to an output voltage in the range of 0.8V-3.6V. The SIL10E offers both fixed outputs and wide output trim range, which allows maximum design flexibility and a pathway for future upgrades. The SIL10E is designed for applications that include distributed power, workstations, optical network and wireless applications.

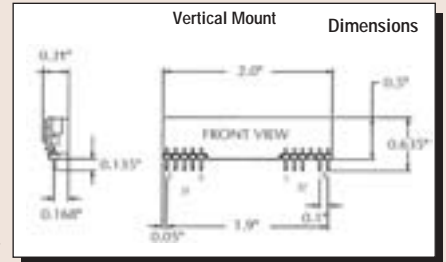

15-Amp SIL15C Series

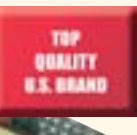

- 91% efficiency
- Ultra-wide trim range
- "Power good" signal
- Protection: over-current & short-circuit
- Working temperature: 0° to +80°C (derated above 50°C)



Highlighted below in buff color, the SIL15C series are new high-density, open frame, non-isolated DC/DC converters for space-sensitive applications. Each model has a wide input range (4.5-5.5V or 10.2-13.8V) and offers a wide output voltage range of either 0.9-3.3V or 0.9-5V with a 15A load.

An external resistor adjusts the output voltage from its pre-set value of 0.9V to any value up to the maximum allowed value for the model. With full international safety approval including EN60950 and UL/CUL60950, the SIL15C Series reduces compliance costs and time to market.

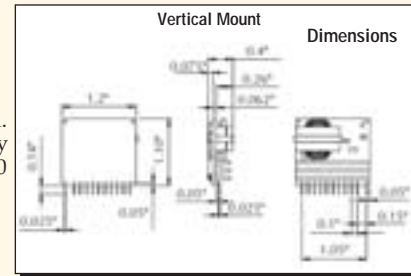

30-Amp SIL30C Series

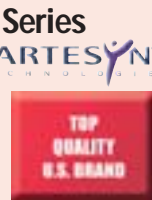

- 91% efficiency
- Ultra-wide trim range
- Horizontal & vertical models
- "Power good" signal
- Protection: over-current, over-temperature & short-circuit
- Working temperature: 0° to +80°C (derated above 50°C)



Highlighted below in rose color, the SIL30C series are new high-density, open-frame, non-isolated DC/DC converters for space sensitive applications. The converters have a wide input range (10.2-13.8VDC) and offer a wide 0.9-5V output voltage range with a 30A load.

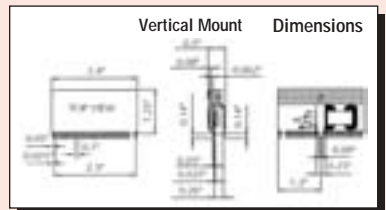
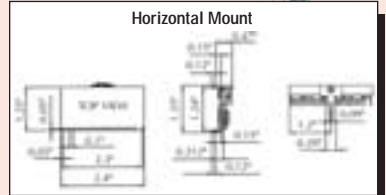

The SIL Series Converters above also have the following features:

- dl/dt: 10A/μs
- 100% burn-in test
- No minimum load
- Planar magnetics technology
- Very high MTBF
- Remote ON/OFF
- Two-year warranty

Mfr.	Manufacturer Product Number*	Input Range	Output		Size Inches (LxWxH)	Pins	Line Reg. (%)	Load Reg. (%)	Temp. °C	Efficiency (%)	MTBF (hours)	Jameco Number	Price			
			Voltage@Current	Power									1	10	25	100
Artesyn	SIL06C-05SADJ-V	4.5V-5.5V	0.9-3.3V@6A	20W	1.20x0.61x0.07	8	0.2	0.5	0 to +80	89	1,300,000	219150CD	\$12.35	\$11.69	\$11.15	\$10.59
Artesyn	SIL06C-05SADJ-H	4.5V-5.5V	0.9-3.3V@6A	20W	1.20x0.61x0.53	8	0.2	0.5	0 to +80	89	1,300,000	219168CD	12.35	11.69	11.15	10.59
Artesyn	SIL10E-05S1V8-V	3.0V-5.5V	1.8V@10A	18W	2.00x0.50x0.31	11	1.0	1.0	-40 to +100	92	7,042,000	219141CD	23.85	22.65	21.55	20.47
Artesyn	SIL10E-05S2V5-V	3.0V-5.5V	2.5V@10A	25W	2.00x0.50x0.31	11	1.0	1.0	-40 to +100	94	7,042,000	219133CD	23.85	22.65	21.55	20.47
Artesyn	SIL10E-05W3V3-V	4.5V-5.5V	0.8-3.6V@10A	33W	2.00x0.50x0.31	11	1.0	1.0	-40 to +100	95	7,042,000	219117CD	23.85	22.65	21.55	20.47
Artesyn	SIL10E-05S3V3-V	4.5V-5.5V	3.3V@10A	33W	2.00x0.50x0.31	11	1.0	1.0	-40 to +100	95	7,042,000	219125CD	23.85	22.65	21.55	20.47
Artesyn	SIL15C-05SADJ-V	4.5V-5.5V	0.9V-3.3V@15A	50W	1.20x1.10x0.40	13	0.2	0.5	0 to +80	89	7,817,000	218886CD	17.19	16.35	15.55	14.75
Artesyn	SIL15C-12SADJ-V	10.2V-13.8V	0.9V-5V@15A	75W	1.20x1.10x0.40	13	0.2	0.5	0 to +80	91	7,817,000	218878CD	17.19	16.35	15.55	14.75
Artesyn	SIL30C-12SADJ-V	10.2V-13.8V	0.9V-5V@30A	150W	2.40x1.25x0.47	24	0.2	1.0	0 to +80	91	129,000	218860CD	26.95	25.59	24.35	23.15
Artesyn	SIL30C-12SADJ-H	10.2V-13.8V	0.9V-5V@30A	150W	2.40x1.25x0.50	24	0.2	1.0	0 to +80	91	129,000	218851CD	26.95	25.59	24.35	23.15

* Suffix: V=Vertical; H=Horizontal





0.5 & 1-Watt Regulated Encapsulated

SRS05 & SPR01 Series: Single Output

- 1000VDC isolation
- Protection: short-circuit
- 100% burn-in test
- Very high MTBF
- Working temperature: -15 to +60°C @ full load
-25 to +71°C @ 80% load
- Input filter: capacitor type
- No external components needed
- One-year warranty



VALUE PRICES & PERFORMANCE

Detailed below in blue, the Mean Well SRS05 and SPR01 series are low-cost, highly reliable, low-power, regulated 0.5-watt and 1.0-watt DC-to-DC converters that are easy to use because no external components are required. Internally they employ high-density SMD technology and are packaged in a non-conductive plastic case for safety. The input-to-output isolation is an impressive 1000VDC, with I/O isolation resistance of 100MΩ and capacitance of 80pF maximum. Short-circuit protection is a standard feature and electrical noise is minimized with a capacitor-type input filter. Line and load regulation are both ±1%.

UNDERSTANDING CONVERTERS #1

PI-FILTER: A commonly used filter at the input of a switching supply or DC/DC converter to reduce reflected ripple current. The filter usually consists of two parallel capacitors and a series of inductance and is generally built into supply.

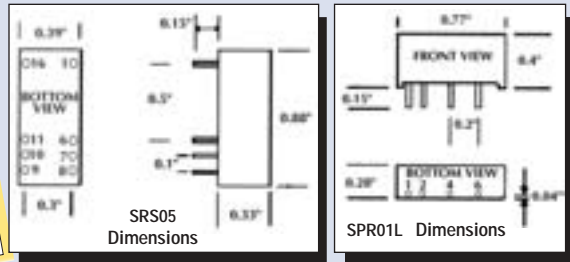

1-Watt Unregulated Encapsulated

SUS01 Series: Single Output

- 1000VDC isolation
- Input filter: capacitor type
- Protection: short-circuit
- No external components needed
- 100% burn-in test
- One-year warranty
- Very high MTBF
- Working temperature: -15 to +60°C @ full load
-25 to +71°C @ 80% load



VALUE PRICES & PERFORMANCE

Shown below in buff color, our lowest price Mean Well DC-to-DC converter is the unregulated 1.0-watt SUS01. It requires no external components and features a capacitor-type input filter for minimum noise. SMD technology is employed for superior reliability and small size. The input-to-output isolation is an impressive 1000VDC, with I/O isolation resistance of 100MΩ and capacitance of 80pF maximum. Adequate for many applications, line regulation is ±1.2% and load regulation from 20% to 100% of full load is ±8%. The dual-in-line non-conductive plastic package makes the SUS01 easy to design in. The working temperature is -15°C to +60°C with no derating and -25°C to +71°C at 80% load.

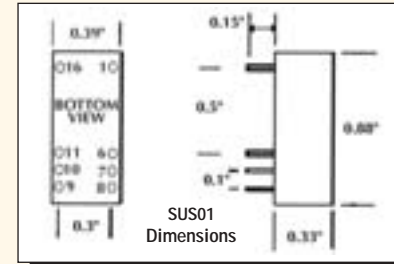

3 & 5-Watt Regulated Encapsulated

DCW03, SCW03, DLW05 & SLW05 Series: Single & Dual Outputs

- 1000VDC isolation
- No external components needed
- 2:1 wide input range
- 100% burn-in test
- Free-air convection cooling
- Protection: short-circuit & overload
- Working temperature: -15 to +60°C @ full load
-25 to +71°C @ 80% load
- Input filter: Pi network
- Industry standard package
- Shielded metal case
- One-year warranty
- Very high MTBF

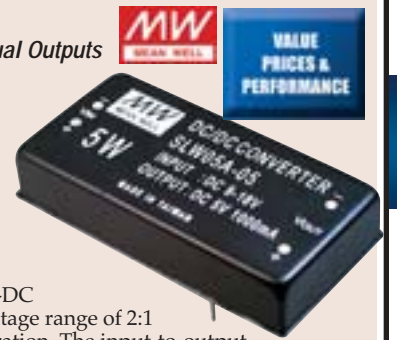

VALUE PRICES & PERFORMANCE

Highlighted below in tan, these popular regulated DC-to-DC converters performance features include a wide input voltage range of 2:1 and the use of a pi-network input filter for low noise operation. The input-to-output isolation is an impressive 1000VDC, with I/O isolation resistance of 100MΩ.

The Mean Well SCW03 and DCW03 families include single and dual-output 3-watt configurations packaged in five-sided shielded metal cases. The industry-standard package size supports full power with free-air convection.

Offering both single and dual outputs, the Mean Well SLW05 & DLW05 5-watt series are very popular because of their low-cost, reliability, and industry-standard package comprised of a six-sided shielded metal case. Continuous short-circuit protection and overload protection, both with auto-recovery, are standard features.

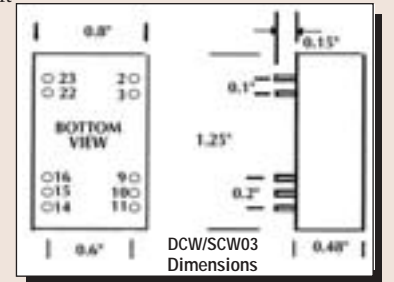
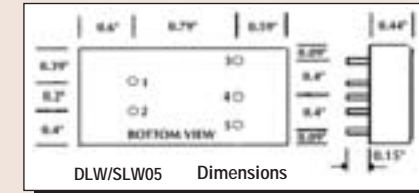

Manufacturer	Manufacturer Product Number	Input Range	Output		Size Inches (LxWxH)	Power Density (W/in ²)	Pins	Ripple & Noise (mV p-p)	Line Reg. (±%)	Load Reg. (±%)	Switching Frequency (Hz)	Isolation Voltage	Temperature °C	Efficiency (%)	MTBF (hours)	Weight (lbs.)	Jameco Number	Price			
			Voltage@Current	Power														1	10	25	100
Mean Well	SRS-0505	4.5-5.5V	+5V@100mA	0.5W	0.88x0.39x0.33	4.63	8	100	1.0	1.0	500k	1,000	-15 to +60	62	600,000	0.01	213225CD	\$9.95	\$8.95	\$8.09	\$7.28
Mean Well	SPR01L-05	4.5-5.5V	+5V@200mA	1.0W	0.77x0.28x0.4	17.86	4	100	1.0	1.0	100k	1,000	-15 to +60	57	800,000	0.01	213313CD	9.95	8.95	8.09	7.28
Mean Well	SPR01L-12	4.5-5.5V	+12V@84mA	1.0W	0.77x0.28x0.4	17.86	4	100	1.0	1.0	100k	1,000	-15 to +60	61	800,000	0.01	216830CD	9.95	8.95	8.09	7.28
Mean Well	SPR01L-15	4.5-5.5V	+15V@67mA	1.0W	0.77x0.28x0.4	17.86	4	100	1.0	1.0	100k	1,000	-15 to +60	62	800,000	0.01	216848CD	9.95	8.95	8.09	7.28
Mean Well	SPR01N-05	21.6-26.4V	+5V@200mA	1.0W	0.77x0.28x0.4	17.86	4	100	1.0	1.0	100k	1,000	-15 to +60	62	800,000	0.01	213250CD	9.95	8.95	8.09	7.28
Mean Well	SUS01L-05	4.5-5.5V	+5V@200mA	1.0W	0.88x0.39x0.33	9.26	8	100	8.0	1.2	100k	1,000	-15 to +60	73	700,000	0.01	213241CD	7.95	7.29	6.49	5.85
Mean Well	SCW03A-05	9-18V	+5V@600mA	3.0W	1.25x0.8x0.48	2.08	10	100	1.0	0.5	25k	1,000	-15 to +60	74	350,000	0.03	213268CD	15.49	13.95	12.59	11.29
Mean Well	SCW03B-05	18-36V	+5V@600mA	3.0W	1.25x0.8x0.48	6.25	10	100	1.0	0.5	25k	1,000	-15 to +60	75	350,000	0.03	213217CD	15.49	13.95	12.59	11.29
Mean Well	DCW03A-05	9-18V	+5V@300mA; -5V@300mA	3.0W	1.25x0.8x0.48	7.14	10	100	1.0	0.5	25k	1,000	-15 to +60	74	350,000	0.03	155918CD	20.95	18.89	16.99	15.29
Mean Well	DCW03A-12	9-18V	+12V@125mA; -12V@125mA	3.0W	1.25x0.8x0.48	5.77	10	100	1.0	0.5	25k	1,000	-15 to +60	80	350,000	0.03	161701CD	20.95	18.89	16.99	15.29
Mean Well	SLW05L-12	4.5-9V	+12V@417mA	5.0W	1.98x0.99x0.44	6.25	5	100	0.2	0.5	50k	1,000	-15 to +60	70	—	0.07	220388CD	24.95	22.49	20.25	18.25
Mean Well	SLW05L-15	4.5-9V	+15V@333mA	5.0W	1.98x0.99x0.44	6.25	5	100	0.2	0.5	50k	1,000	-15 to +60	72	—	0.07	220370CD	24.95	22.49	20.25	18.25
Mean Well	SLW05A-033	9-18V	+3.3V@1500mA	5.0W	1.98x0.99x0.44	6.25	5	100	0.2	0.5	50k	1,000	-15 to +60	70	—	0.07	220353CD	24.95	22.49	20.25	18.25
Mean Well	SLW05A-05	9-18V	+5V@1000mA	5.0W	1.98x0.99x0.44	6.25	5	100	1.0	0.2	50k	1,000	-15 to +60	75	500,000	0.07	216928CD	24.95	22.49	20.25	18.25
Mean Well	SLW05A-12	9-18V	+12V@417mA	5.0W	1.98x0.99x0.44	6.25	5	100	1.0	0.2	50k	1,000	-15 to +60	80	500,000	0.07	216899CD	24.95	22.49	20.25	18.25
Mean Well	SLW05A-15	9-18V	+15V@333mA	5.0W	1.98x0.99x0.44	6.25	5	100	1.0	0.2	50k	1,000	-15 to +60	81	500,000	0.07	216881CD	24.95	22.49	20.25	18.25
Mean Well	SLW05B-033	18-36V	+3.3V@1500mA	5.0W	1.98x0.99x0.44	6.25	5	100	0.2	0.5	50k	1,000	-15 to +60	71	—	0.07	220361CD	24.95	22.49	20.25	18.25
Mean Well	SLW05B-05	18-36V	+5V@1000mA	5.0W	1.98x0.99x0.44	6.25	5	100	1.0	0.2	50k	1,000	-15 to +60	77	500,000	0.07	216936CD	24.95	22.49	20.25	18.25
Mean Well	SLW05B-12	18-36V	+12V@417mA	5.0W	1.98x0.99x0.44	6.25	5	100	1.0	0.2	50k	1,000	-15 to +60	82	500,000	0.07	216910CD	24.95	22.49	20.25	18.25
Mean Well	SLW05B-15	18-36V	+15V@333mA	5.0W	1.98x0.99x0.44	6.25	5	100	1.0	0.2	50k	1,000	-15 to +60	83	500,000	0.07	216872CD	24.95	22.49	20.25	18.25
Mean Well	SLW05C-05	36-72V	+5V@1000mA	5.0W	1.98x0.99x0.44	6.25	5	100	1.0	0.2	50k	1,000	-15 to +60	77	500,000	0.07	213233CD	24.95	22.49	20.25	18.25
Mean Well	SLW05C-12	36-72V	+12V@417mA	5.0W	1.98x0.99x0.44	6.25	5	100	1.0	0.2	50k	1,000	-15 to +60	83	500,000	0.07	216901CD	24.95	22.49	20.25	18.25
Mean Well	DLW05A-12	9-18V	+12V@208mA; -12V@208mA	5.0W	1.98x0.99x0.44	6.25	5	100	2.0	0.2	50k	1,000	-15 to +60	80	500,000	0.07	216856CD	28.95	26.09	23.15	20.85
Mean Well	DLW05B-12	18-36V	+12V@208mA; -12V@208mA	5.0W	1.98x0.99x0.44	6.25	5	100	2.0	0.2	50k	1,000	-15 to +60	82	500,000	0.07	216864CD	28.95	26.09	23.15	20.85

Limited Supply – Special Offers – 90-Day Warranty

Limited Supply – Special Offers – 90-Day Warranty

Manufacturer	Manufacturer Product Number	Input Range	Output		Size Inches (LxWxH)	Power Density (W/in ²)	Pins	Ripple & Noise (mV p-p)	Line Reg. (±%)	Load Reg. (±%)	Switching Frequency (Hz)	Isolation Voltage	Temperature °C	Efficiency (%)	MTBF (hours)	Weight (lbs.)	Jameco Number	Price			
			Voltage@Current	Power														1	10	25	100
Trimag	TDB4W-4805S	36-72V	+5V@500mA	3.0W	1.2x0.8x0.5	6.25	12	50	1.0	1.0	25k	500	-25 to +70	70	400,000	0.03	206076CD	\$9.95	\$8.99	\$8.09	\$7.25
Universal Microelectronics	UM1014	36-72V	+5V@250mA; -5V@250mA	3.0W	1.2x0.8x0.4	7.81	14	100	0.5	0.2	200k	1,000	-25 to +71	77	—	0.03	206092CD	9.95	8.99	8.09	7.25





25-Watt Enclosed

SD25 Series: Single Output



New Lower Quantity Prices

VALUE PRICES & PERFORMANCE

- 1000VDC isolation
- Input filter: Pi-network
- Protection: short-circuit, overload & over-voltage
- Free-air convection cooling
- 2:1 wide input range
- Industry standard package
- Shielded metal case
- 105°C output capacitor
- 100% burn-in test
- One-year warranty
- Very high MTBF
- Working temperature: -10° to +60°C (see derating curve)

Highlighted below in blue and well known for its reliability and low cost, the Mean Well SD-25 family of enclosed DC-to-DC converters offers wide 2:1 input voltage ranges. The physical ruggedness is complemented by the many electrical protections; short-circuit, overload with auto-recovery, and over-voltage to 165% of rated output. The input-to-output isolation is 500VDC and the isolation resistance is 100MΩ at 500VDC. The highly-efficient, low-temperature design provides full power from 0°C to 40°C, with derating to -10°C and +60°C (see derating curve). The line and load regulation are both ±0.5% maximum. The Mean Well SD-25 series complies with EMC standards EN55022 class B and EN61000-4-2/3/4/6/8.

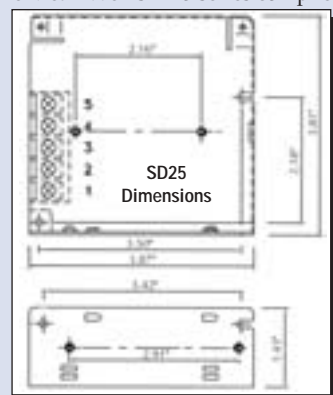
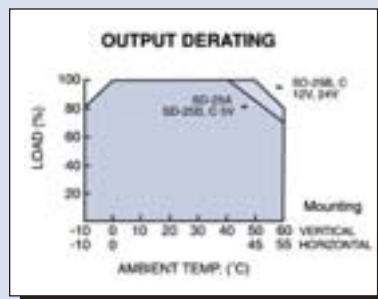

30-Watt Encapsulated

DKA30 & TKA30 Series: Dual & Triple Output



VALUE PRICES & PERFORMANCE

- ±0.2% regulation
- 1000VDC isolation
- Input filter: Pi-network
- Protection: short-circuit & overload
- Free-air convection cooling
- 2:1 wide input range
- Industry standard package
- Shielded metal case
- Remote ON/OFF
- 100% burn-in test
- One-year warranty
- Very high MTBF
- Output trim
- Working temperature: -40° to +71°C

Detailed below in buff color, the Mean Well DKA30 & TKA30 families of regulated 30-watt DC-to-DC converters include popular dual and triple-output configurations packaged in six-sided, shielded metal cases. Line and load regulation are both an outstanding ±0.2%. Load regulation applies for a load change of 10% to full load for both dual and triple-outputs. The industry-standard package supports full power with free-air convection over the ambient temperature range of -40°C to 71°C. Performance features include a wide input voltage range of 2:1 and the use of a pi-network input filter for low noise operation. The input-to-output isolation is an impressive 1000VDC, with I/O isolation resistance of 1000MΩ. Short-circuit and over-voltage protection is included. For ease of use, the DKA30 & TKA30 units require no external components and provide both voltage trim and remote ON/OFF capability.

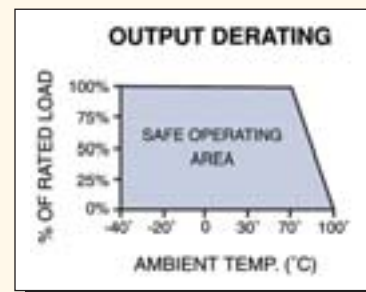
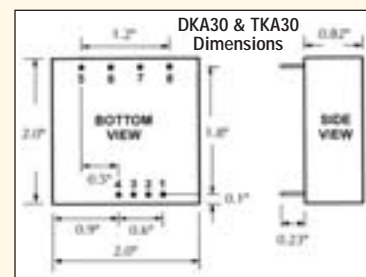

30-Watt Regulated Encapsulated

SDM30 Series: Single Output

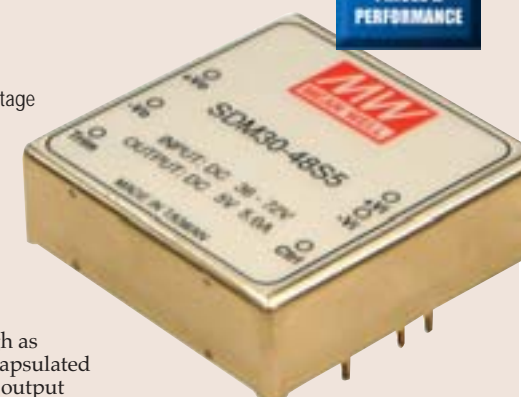

VALUE PRICES & PERFORMANCE

- 1000VDC isolation
- Input filter: Pi-network
- Protection: short-circuit, overload & over-voltage
- Free-air convection cooling
- Industry standard package
- 2:1 wide input range
- Shielded metal case
- Remote ON/OFF
- 100% burn-in test
- One-year warranty
- Very high MTBF
- Output trim
- Working temperature: -25° to +85°C

Shown below in tan, with efficiency as high as 85%, this impressive family of 30-watt encapsulated DC-to-DC converters provides full power output with free-air convection cooling. The compact size of 2.0"x2.0"x0.63" and the 6-sided shielded metal case lend to its easy adaptability to numerous types of applications. Input voltage ranges are a full 2:1. The line and load regulation are both a solid ±1%. Protection includes short-circuit, overload to 105% with auto-recovery, and over-voltage to 150% of rated output. The isolation voltage is 1000VDC and the resistance is 100MΩ at 500VDC. The SDM30 series features ±10% trimming output and remote ON/OFF control. They completely comply with EN55022 class B, FCC part 15J and EN60950 safety and EMI requirements.

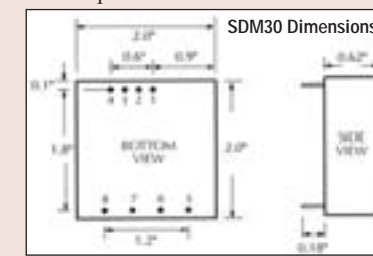
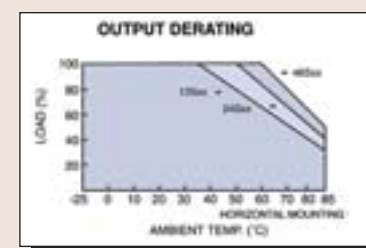

	Manufacturer	Manufacturer Product Number	Input Range	Output		Size Inches (LxWxH)	Power Density (W/in ²)	Pins	Ripple & Noise (mV p-p)	Line Reg. (±%)	Load Reg. (±%)	Switching Frequency (Hz)	Isolation Voltage	Temperature °C	Efficiency (%)	MTBF (hours)	Weight (lbs.)	Jameco Number	Price			
				Voltage@Current	Power														1	10	25	100
Enclosed	Mean Well	SD-25A-5	9-18V	+5V@5000mA	25.0W	see diagram	1.2	5	100	0.5	0.5	—	500	-10 to +60	71	—	0.80	175661CD	\$40.95	\$30.99	\$28.99	\$24.99
	Mean Well	SD-25A-12	9-18V	+12V@2100mA	25.2W	see diagram	1.2	5	120	0.3	0.3	—	500	-10 to +60	72	—	0.80	175804CD	40.95	30.99	28.99	24.99
	Mean Well	SD-25A-24	9-18V	+24V@1100mA	26.4W	see diagram	1.2	5	150	0.2	0.2	—	500	-10 to +60	75	—	0.80	175812CD	40.95	30.99	28.99	24.99
	Mean Well	SD-25B-5	19-36V	+5V@5000mA	25.0W	see diagram	1.2	5	100	0.5	0.5	—	500	-10 to +60	72	—	0.80	212556CD	40.95	30.99	28.99	24.99
	Mean Well	SD-25C-5	36-72V	+5V@5000mA	25.0W	see diagram	1.2	5	100	0.5	0.5	—	500	-10 to +60	74	—	0.80	216629CD	40.95	30.99	28.99	24.99
Encapsulated	Mean Well	DKA30A-12	9-18V	+12V@1250mA; -12V@1250mA	30.0W	2.0x2.0x0.82	9.4	8	100	0.2	0.2	100k	1,000	-40 to +71	80	700,000	0.25	217701CD	64.95	58.45	52.59	47.35
	Mean Well	DKA30B-12	18-36V	+12V@1250mA; -12V@1250mA	30.0W	2.0x2.0x0.82	9.4	8	100	0.2	0.2	100k	1,000	-40 to +71	85	700,000	0.25	218544CD	64.95	58.45	52.59	47.35
	Mean Well	DKA30C-12	36-72V	+12V@1250mA; -12V@1250mA	30.0W	2.0x2.0x0.82	9.4	8	100	0.2	0.2	100k	1,000	-40 to +71	82	700,000	0.25	217699CD	64.95	58.45	52.59	47.35
	Mean Well	TKA30A-B	9-18V	+5V@3500mA; +12V@310mA; -12V@310mA	25.0W	2.0x2.0x0.82	7.8	8	100	0.2	0.2	100k	1,000	-40 to +71	80	700,000	0.25	217736CD	69.65	62.65	56.39	50.75
	Mean Well	TKA30B-C	18-36V	+5V@3500mA; +15V@250mA; -15V@250mA	25.0W	2.0x2.0x0.82	7.8	8	100	0.2	0.2	100k	1,000	-40 to +71	82	700,000	0.25	217728CD	69.65	62.65	56.39	50.75
	Mean Well	TKA30C-B	36-72V	+5V@3500mA; +12V@310mA; -12V@310mA	25.0W	2.0x2.0x0.82	7.8	8	100	0.2	0.2	100k	1,000	-40 to +71	82	700,000	0.25	217681CD	69.65	62.65	56.39	50.75
	Mean Well	SDM30-12S05	9-18V	+5V@5000mA	25.0W	2.0x1.8x0.62	10.4	8	75	1.0	1.0	—	1,000	-25 to +85	77	—	0.22	217200CD	45.95	41.35	37.25	33.55
	Mean Well	SDM30-12S12	9-18V	+12V@2100mA	25.2W	2.0x1.8x0.62	10.5	8	100	1.0	1.0	—	1,000	-25 to +85	80	—	0.22	217234CD	45.95	41.35	37.25	33.55
	Mean Well	SDM30-12S15	9-18V	+15V@1700mA	25.5W	2.0x1.8x0.62	10.5	8	100	1.0	1.0	—	1,000	-25 to +85	80	—	0.22	217189CD	45.95	41.35	37.25	33.55
	Mean Well	SDM30-24S05	18-36V	+5V@5000mA	25.0W	2.0x1.8x0.62	10.4	8	75	1.0	1.0	—	1,000	-25 to +85	79	—	0.22	217218CD	45.95	41.35	37.25	33.55
	Mean Well	SDM30-24S12	18-36V	+12V@2500mA	30.0W	2.0x1.8x0.62	12.5	8	100	1.0	1.0	—	1,000	-25 to +85	82	—	0.22	217242CD	45.95	41.35	37.25	33.55
	Mean Well	SDM30-24S15	18-36V	+15V@2000mA	30.0W	2.0x1.8x0.62	12.5	8	100	1.0	1.0	—	1,000	-25 to +85	83	—	0.22	217171CD	45.95	41.35	37.25	33.55
	Mean Well	SDM30-48S05	36-72V	+5V@5000mA	25.0W	2.0x1.8x0.62	10.4	8	75	1.0	1.0	—	1,000	-25 to +85	80	—	0.22	217226CD	45.95	41.35	37.25	33.55
	Mean Well	SDM30-48S12	36-72V	+12V@2500mA	30.0W	2.0x1.8x0.62	12.5	8	100	1.0	1.0	—	1,000	-25 to +85	84	—	0.22	217251CD	45.95	41.35	37.25	33.55
	Mean Well	SDM30-48S15	36-72V	+15V@2000mA	30.0W	2.0x1.8x0.62	12.5	8	100	1.0	1.0	—	1,000	-25 to +85	85	—	0.22	217197CD	45.95	41.35	37.25	33.55

Other Versions Available: Call 800-831-4242

Limited Supply – Special Offers – 90-Day Warranty

	Manufacturer	Manufacturer Product Number	Input Range	Output		Size Inches (LxWxH)	Power Density (W/in ²)	Pins	Ripple & Noise (mV p-p)	Line Reg. (±%)	Load Reg. (±%)	Switching Frequency (Hz)	Isolation Voltage	Temperature °C	Efficiency (%)	MTBF (hours)	Weight (lbs.)	Jameco Number	Price			
				Voltage@Current	Power														1	10	25	100
Encapsulated	Universal Microelectronics	UM1106	9-18V	+5V@3000mA; +12V@450mA; -12V@450mA	25.0W	4.5x2.6x0.8	2.7	8	75	1.0	5.0	—	500	-25 to +71	74	—	0.60	206084CD	\$19.95	\$17.99	\$16.19	\$14.55





60-Watt Open Frame

EXQ60 Series Dual Outputs

- 1500VDC isolation
- Industry standard footprint
- Protection: short-circuit, over-current & over-voltage
- 100% burn-in test
- Two-year warranty
- Very high MTBF
- Remote ON/OFF
- No minimum load
- 91% efficiency at 5V & 3.3V
- Output trim
- Planar magnetics technology
- Working temperature: -40 to +100°C

Detailed below in blue, the EXQ60 is a new dual-output, high-efficiency, open-frame, isolated 60-watt DC-to-DC converter series in an industry-standard quarter-brick footprint. The EXQ60 delivers very high output current at low voltages, and excellent useable power density for today's high-end applications. The models offered feature an input voltage range of 33 to 75VDC and are available in output voltages of 2.5V/3.3V and 3.3V/5V. The output voltage on each model is adjustable from 90% to 110% of the nominal value. Typical efficiencies for the models are 90% for the 2.5V/3.3V and 91% for the 3.3V/5V versions. The EXQ60 Series also has a remote ON/OFF capability. Over-current and over-voltage protection features are included as standard. With full international safety approval including EN60950 and UL1950, the EXQ60 reduces compliance cost and time to market.

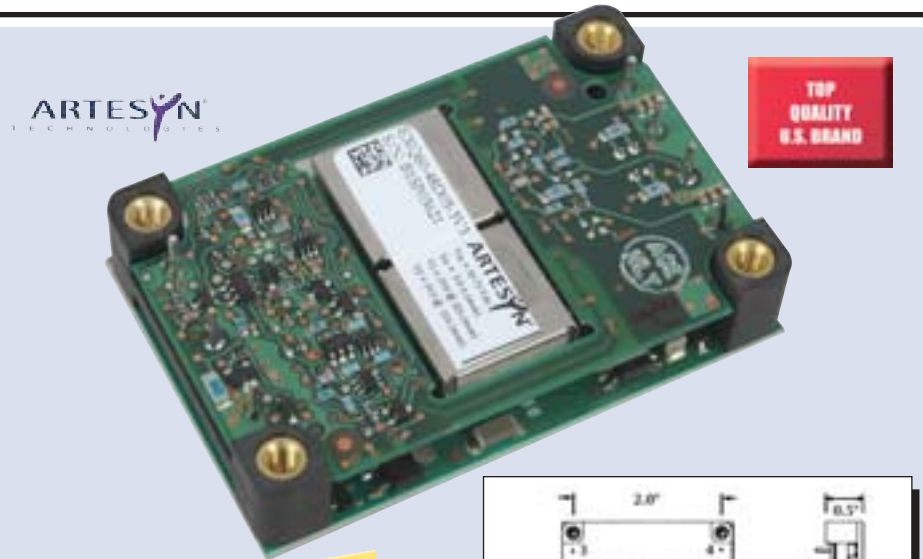

UNDERSTANDING CONVERTERS #4
PLANAR MAGNETICS: Planar magnetics use high volume manufacturing processes and technologies to replace conventional wire windings in magnetic components with patterned conductors formed on single or multilayer substrates. Planar magnetics offer tremendous advantages in terms of cost, reliability, manufacturability and predictable electrical parameters.

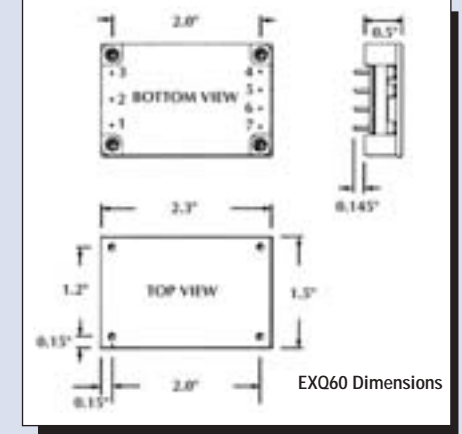

50, 100 & 150-Watt Enclosed

SD50, SD100 & SD150 Series: Single Output

- 1000VDC isolation
- Protection: short-circuit, overload & over-voltage
- 100% burn-in test
- Very high MTBF
- Free-air convection cooling
- 2:1 wide input range
- Working temperature: -10° to +60°C (see derating curve)
- Input filter: Pi-network
- One-year warranty
- Shielded metal case
- Industry standard package
- 105°C output capacitor

Highlighted below in tan, the Mean Well SD families of enclosed DC-to-DC converters are known for their reliability and low cost. The physical ruggedness is complemented by the many electrical protections; short-circuit, overload with auto-recovery, and over-voltage to 165% of rated output. These converters offer wide 2:1 input voltage ranges of 9-18VDC and 36-72VDC. The input-to-output isolation is 500VDC and the isolation resistance is 100MΩ at 500VDC. The highly-efficient, low-temperature design provides full power from 0°C to 40°C, with derating to -10°C and +60°C (see derating curve). The line and load regulation are both ±0.5% maximum. The Mean Well SD series complies with EMC standards EN55022 class B and EN61000-4-2/3/4/6/8.

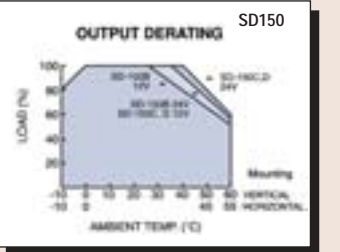
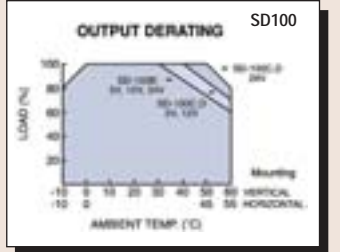
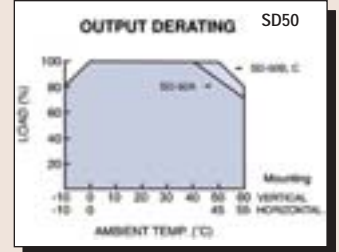
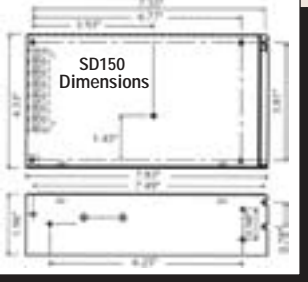
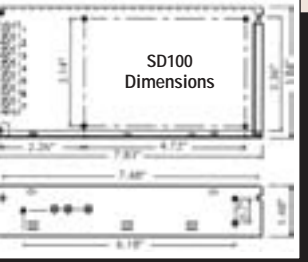
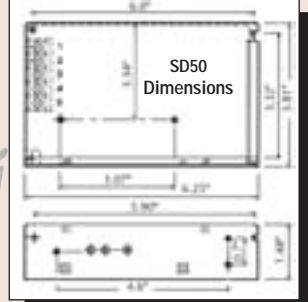

	Manufacturer	Manufacturer Product Number	Input Range	Output		Size Inches (LxWxH)	Power Density (W/in ²)	Pins	Ripple & Noise (mV p-p)		Line Reg. (±%)	Load Reg. (±%)	Switching Frequency (Hz)	Isolation Voltage	Temperature °C	Efficiency (%)	MTBF (hours)	Weight (lbs.)	Certification	Jameco Number	Price				
				Voltage@Current	Power																1	10	25	100	
Open Frame	Artesyn	EXQ60-48D3V3-2V5-R	33-75V	+2.5V@16A; +3.3V@12A	40.0W	2.3x1.5x0.5	46.4	7	60		—	—	325k	1,500	-40 to +100	90.5	270,000	0.10	UL/CUL/TUV	218894CD	\$134.95	\$115.35	\$108.59	\$103.59	Open Frame
	Artesyn	EXQ60-48D05-3V3-R	33-75V	+3.3V@15A; +5V@12A	60.0W	2.3x1.5x0.5	63.8	7	60		—	—	400k	1,500	-40 to +100	91.5	270,000	0.10	UL/CUL/TUV	218907CD	134.95	115.35	108.59	103.59	
Enclosed	Mean Well	SD-50A-5	9-18V	+5V@10A	50.0W	see diagram	1.4	5	100		0.5	0.5	—	1,500	-10 to +60	70	—	1.10	—	212548CD	51.95	39.99	36.99	32.99	Enclosed
	Mean Well	SD-50B-5	19-36V	+5V@10A	50.0W	see diagram	1.4	5	100	↔	0.5	0.5	—	1,500	-10 to +60	73	—	1.10	—	212521CD	51.95	39.99	36.99	32.99	
	Mean Well	SD-50B-12	19-36V	+12V@4.2A	50.4W	see diagram	1.4	5	120		0.3	0.3	—	1,500	-10 to +60	75	—	1.10	—	212530CD	51.95	39.99	36.99	32.99	
	Mean Well	SD-50B-24	19-36V	+24V@2.1A	50.4W	see diagram	1.4	5	150		0.2	0.2	—	1,500	-10 to +60	80	—	1.10	—	212513CD	51.95	39.99	36.99	32.99	
	Mean Well	SD-50C-5	36-72V	+5V@10A	50.0W	see diagram	1.4	5	100		0.5	0.5	—	1,500	-10 to +60	76	—	1.10	—	216602CD	51.95	39.99	36.99	32.99	
	Mean Well	SD-50C-12	36-72V	+12V@4.2A	50.4W	see diagram	1.4	5	120		0.3	0.3	—	1,500	-10 to +60	78	—	1.10	—	212505CD	51.95	39.99	36.99	32.99	
	Mean Well	SD-50C-24	36-72V	+24V@2.1A	50.4W	see diagram	1.4	5	150		0.2	0.2	—	1,500	-10 to +60	83	—	1.10	—	212492CD	51.95	39.99	36.99	32.99	
	Mean Well	SD-100B-5	19-36V	+5V@20A	100.0W	see diagram	2.3	7	100		0.5	0.5	—	1,500	-10 to +60	74	—	1.30	—	212476CD	72.95	53.99	50.99	44.99	
	Mean Well	SD-100B-12	19-36V	+12V@8.5A	102.0W	see diagram	2.3	7	120	↔	0.3	0.3	—	1,500	-10 to +60	75	—	1.30	—	216565CD	72.95	53.99	50.99	44.99	
	Mean Well	SD-100C-5	36-72V	+5V@20A	100.0W	see diagram	2.3	7	100		0.5	0.5	—	1,500	-10 to +60	75	—	1.30	—	212484CD	72.95	53.99	50.99	44.99	
	Mean Well	SD-100C-12	36-72V	+12V@8.5A	102.0W	see diagram	2.3	7	120		0.3	0.3	—	1,500	-10 to +60	77	—	1.30	—	212468CD	72.95	53.99	50.99	44.99	
	Mean Well	SD-150B-12	19-36V	+12V@12.5A	150.0W	see diagram	2.5	7	120		0.5	0.5	—	1,500	-10 to +60	75	—	1.90	—	217269CD	82.95	70.99	65.99	57.99	

Limited Supply - Special Offers - 90-Day Warranty																									
	Manufacturer	Manufacturer Product Number	Input Range	Output		Size Inches (LxWxH)	Power Density (W/in ²)	Pins	Ripple & Noise (mV p-p)		Line Reg. (±%)	Load Reg. (±%)	Switching Frequency (Hz)	Isolation Voltage	Temperature °C	Efficiency (%)	MTBF (hours)	Weight (lbs.)	Certification	Jameco Number	Price				
				Voltage@Current	Power																1	10	25	100	
Encapsulated	Shindengen	HGE05024	20-32V	+5V@24A	120.0W	4.5x2.3x0.5	23.2	13	400		0.01	0.05	—	—	-10 to +80	80	—	—	—	206105CD	\$29.95	\$26.99	\$24.29	\$21.89	Encapsulated
	Power One	HBD0602GE-A1V1	34-75V	+3.3V@15A; +5V@12A	60.0W	2.3x2.4x0.5	21.7	10	75/100	↔	0.2	0.5	500k	1,500	-40 to +100	79	1,300,000	0.15	UL/CUL/VDE	203561CD	19.95	17.99	16.19	14.59	
	Datel	BCP-5/15-3.3/15-D48	36-75V	+3.3V@15A; +5V@15A	75.0W	2.3x2.4x0.5	27.2	10	50		0.2	0.5	350k	1,500	-40 to +45	88	1,720,000	0.26	UL/VDE	206113CD	24.95	22.49	20.25	18.25	
	Astec	AK60C048L050F20G	36-75V	+5V@20A	100.0W	2.3x2.4x0.5	36.2	9	1		0.2	0.2	—	2,100	-40 to +100	—	—	—	UL/CSA/VDE/CE	188197CD	19.95	17.99	16.19	14.59	
	Power Cube	PD150-048-05-PC	36-76V	+5V@30A	150.0W	2.3x2.4x0.5	54.3	9	50		0.05	0.05	375k	3,000	—	80	1,000,000	0.16	UL/CUL/VDE	206041CD	29.95	26.99	24.29	21.89	
	Power Cube	PD300-300-15-PC	200-300V	+15V@20A	300.0W	4.6x2.4x0.5	54.3	11	150	↔	0.05	0.05	375k	3,000	—	80	1,000,000	0.37	UL/CUL/VDE	206033CD	39.95	35.99	32.39	29.15	
Lambda	PH300F-280-3	200-400V	+3V@60A	180.0W	5.8x3.4x0.5	18.3	12	100		0.4	0.8	3k	3,000	-20 to +85	73	5,000,000	0.56	UL/CSA/CE	206121CD	32.95	29.69	26.69	24.25		



- Low cost, high reliability
- International AC input range
- Soft-start circuit, limiting AC surge current
- Short-circuit, overload, over-voltage protected
- Built in EMI filter, low ripple noise
- 100% full-load burn-in test
- For DIN-Rail terminal blocks see page 133

UL-508



SALE



192698CD



212273CD



212290CD

New



221891CD

Part No.	Product No.	Power (W)	Output Volts@Current	Input Voltage (VAC @ Hz/VDC)	Input Current @ Maximum Load	Size (L" x W" x H")	Wt. (lbs.)	1	10	25
212302CD	DR4505	25	5VDC @ 5A	85-264 @ 47-63/120-370	1.5A(115V)/750mA(230V)	3.0 x 2.6 x 3.6	0.9	\$45.95	\$31.99	\$29.99
192698CD	DR4512	42	12VDC @ 3.5A	85-264 @ 47-63/120-370	1.5A(115V)/750mA(230V)	3.0 x 2.6 x 3.6	0.7	45.95	31.99	29.99
221874CD	DR4515	42	15VDC @ 2.8A	85-264 @ 47-63/120-370	1.5A(115V)/750mA(230V)	3.0 x 2.6 x 3.6	0.9	45.95	31.99	29.99
192680CD	DR4524	48	24VDC @ 2A	85-264 @ 47-63/120-370	1.5A(115V)/750mA(230V)	3.0 x 2.6 x 3.6	0.7	45.95	31.99	29.99
212290CD	DR7512	75	12VDC @ 6.3A	85-264 @ 47-63/120-370	2.0A(115V)/1.2A(230V)	3.9 x 2.1 x 4.9	1.2	73.95	50.99	46.99
212281CD	DR7524	75	24VDC @ 3.2A	85-264 @ 47-63/120-370	2.0A(115V)/1.2A(230V)	3.9 x 2.1 x 4.9	1.2	73.95	50.99	46.99
221866CD	DR7548	76.8	48VDC @ 1.6A	85-264 @ 47-63/120-370	2.0A(115V)/1.2A(230V)	3.9 x 2.1 x 4.9	1.2	73.95	50.99	46.99
212273CD	DR12012	120	12VDC @ 10A	88-132/176-264* @ 47-63	2.8A(115V)/1.7A(230V)	2.6 x 3.9 x 4.9	1.4	85.95	58.99	54.99
212265CD	DR12024	120	24VDC @ 5A	88-132/176-264* @ 47-63	2.8A(115V)/1.7A(230V)	2.6 x 3.9 x 4.9	1.4	85.95	58.99	54.99
221903CD	DR12048	120	48VDC @ 2.5A	88-132/176-264* @ 47-63	2.8A(115V)/1.7A(230V)	2.6 x 3.9 x 4.9	1.4	85.95	58.99	54.99
221891CD	DRP24024	240	24VDC @ 10A	85-264 @ 47-63/120-370	3.5A(115V)/1.8A(230V)	3.9 x 4.9 x 4.9	2.4	156.95	101.99	94.99
221882CD	DRP24048	240	48VDC @ 5.0A	85-264 @ 47-63/120-370	3.5A(115V)/1.8A(230V)	3.9 x 4.9 x 4.9	2.4	156.95	101.99	94.99

* Switch selectable

Din Mounting Rail

DIN rail enables easy installation of components such as fuseable terminal blocks & power supplies configured for DIN mounting.

- Sold in 1 meter (39") length

Additional Mounting Rails see page 224

185965CD



Part No.	Product No.	Description	Material	Type	Length	1	10	100
185965CD	017322005	Prepunched	Zinc bichromate plate steel	PR30	1 meter (39")	\$5.95	\$5.35	\$4.79

13.8VDC Precision Regulated Linear Power Supplies

- Output voltage: 13.8VDC
- Input voltage: 115VAC @ 60Hz
- Illuminated rocker switch
- Heavy duty 5'8" 3-prong power cord
- Short-circuit protection • Fuse protected
- Output terminals: see page 59 for mating cigarette plugs and page 151 for mating banana terminal plugs

135845CD
Banana & Cigarette



136581CD
Banana terminal



138667CD
Banana terminal (rear)



Part No.	Model No.	Power (W)	Output Current (A)	Output Terminals	Size (L" x W" x H")	Wt. (lbs.)	1	10	25
135845CD	RPS1204	55.2	4	Banana terminals / cigarette plug	6.7 x 5.2 x 3.2	5.5	\$29.95	\$26.95	\$23.95
136581CD	RPS1207†	96.6	7	Banana terminals	8.7 x 5.7 x 3.6	8.5	59.95	53.95	48.95
138667CD	38-381	138.0	10	Banana terminals (rear)	7.0 x 6.6 x 4.3	10.0	69.95	62.95	56.95
138675CD	52-192012	276.0	20	Banana terminals	10.0 x 7.8 x 4.4	15.9	109.95	99.95	89.95

† P/N 136581CD includes overheating protection



Linear Power Supplies

- Input voltage: 100/120/220/240VAC @ 47-63Hz
- Input connector: 0.119" solder terminals
- Output connector: solder post
- MTBF rating: greater than 300,000 hours
- Ripple and noise: 5.0mVp-p • Efficiency: 45%
- Over-voltage, over-current, short-circuit protection, remote sensing and 100% burn-in



202884CD: Output voltage: +5VDC @ 1.5A; -5VDC @ 1.5A
202892CD: Output voltage: +5VDC @ 3.0A; -5VDC @ 3.0A

Part No.	Product No.	Power	Size (L x W x H)	Weight (lbs.)	1	10	50
202884CD	HAA5-1.5/OVP-A	15W	6.5" x 4.0" x 1.6"	2.6	\$14.95	\$11.25	\$8.45
202892CD	HBB5-3/OVP-A	30W	7.0" x 4.9" x 2.5"	4.7	17.95	15.29	11.45

ACDC Electronics

45-Watt Linear Power Supply

- Output voltage: 15V @ 3A
- Input voltage: 115VAC @ 50-60Hz
- Input connector: 0.173" solder terminals
- Output connector: solder studs
- Size: 5.6"L x 5.0"W x 3.0"H • Weight: 4.0 lbs.



Part No.	Product No.	1	10	25
214615CD	ECV15N3	\$39.95	\$35.95	\$32.49

Current Sensing Transformers

Class 1 Current Transformer

This series can be applied to test, control, display, and record the running of electrical equipment, and to protect the equipment against damage in the AC circuit.

- Maximum voltage: 660VAC
- Size: 3.0"L x 3.2"W x 1.6" thick
- Frequency: 50-60Hz
- Weight: 1.1 lbs.

Includes: Mounting bracket and hardware



Current Sensing Transformer

- Inductance: 5mH • Turns: 60
- Sensitivity current (I_{in}): 1A
- Max. current: 300mA
- Freq. range: 10-50 kHz
- Sensitivity voltage (V_{out}): 1V
- Terminating resistor: 50Ω
- Size: 0.8"H x 0.7"W x 0.4"T



Part No.	Mfr. Cross Ref. No.	Power	Ratio	1	10	100
174887CD	MSQ30	5VA	200A/5A; 5VA	\$4.25	\$3.82	\$3.44

Part No.	Mfr. Cross Ref. No.	1	10	100
164718CD	MTC30101	\$2.15	\$1.95	\$1.75

Split-Bobbin Power Transformers

Non-concentrically wound with primaries and secondaries side-by-side providing low capacitive coupling.

- Primary: 115/230VAC, 50-60Hz
- PC terminal pin spacing for accurate placement

Part Number	Mfr. Cross Ref. No.	Triad Cross	Input Voltage	VA Cap	Individual Output	Parallel Output	Series Output	Dimensions			Wt. (lbs.)	Pricing		
								L"	W"	H"		1	10	100
221292CD	DSW-312	FS12200	115/230	2.5	6.3V @ .20A	6.3V @ .40A	12.6VCT @ .20A	1.38	1.13	1.19	0.3	\$5.95	\$4.95	\$4.25
102533CD	XFR1205SB	FS12500	115/230	6.3	6.3V @ .50A	6.3V @ 1.0A	12.6VCT @ .50A	1.31	1.62	1.30	0.4	7.29	6.49	5.75
102517CD	XFR1602SB	FS16150	115/230	2.4	8V @ .15A	8V @ .30A	16VCT @ .15A	1.17	1.38	1.20	0.3	6.95	6.25	5.59
221284CD	DSW-316	FS16150	115/230	2.5	8V @ .15A	8V @ .30A	16VCT @ .15A	1.38	1.13	1.19	0.3	5.95	4.95	4.25
210921CD	14A-10-ZOB21	—	115/230	10.0	10V @ .05A	10V @ 1.0A	20VCT @ 0.5A	1.88	1.56	1.38	0.5	7.49	6.75	6.09
210948CD	DPC20-60B13	—	115/230	1.2	10V @ .06A	10V @ .12A	20VCT @ .06A	1.63	1.25	1.38	0.2	5.79	5.19	4.69
210956CD	DST2-24-845	—	115/230	1.1	12V @ .045A	12V @ .09A	24VCT @ .045A	1.13	1.13	0.94	0.2	6.49	5.85	5.25
221305CD	DSW-324	FS24100	115/230	2.5	12V @ .10A	12V @ .20A	24VCT @ .10A	1.38	1.13	1.19	0.3	5.95	4.95	4.25
176090CD	SPT41240-120	FS24250	115/230	6.0	12V @ .25A	12V @ .50A	24VCT @ .25A	1.33	1.63	1.59	0.5	6.95	6.25	5.59
102592CD	XFR2405SB	FS24500	115/230	12.0	12V @ .50A	12V @ 1.0A	24VCT @ .50A	1.58	1.90	1.46	0.7	8.79	7.95	5.49
210930CD	PC34-35-B21	—	115	1.2	17V @ .035A	17V @ .07A	34VCT @ .035A	1.38	1.13	1.19	0.2	6.79	6.09	5.49
210964CD	LP40-300-B14	—	115/230	12.0	20V @ .30A	20V @ 0.6A	40VCT @ 0.3A	2.50	2.00	1.07	0.7	9.95	8.95	7.95
209015CD	ST-6-48	—	115	19.2	24V @ .40A	24V @ .80A	48VCT @ .40A	1.88	2.25	1.40	0.8	8.95	8.09	7.25
203318CD	P8616	—	115/230	24.0	24V @ .50A	24V @ 1.0A	48VCT @ .50A	1.96	2.25	2.70	1.5	6.95	6.25	5.59

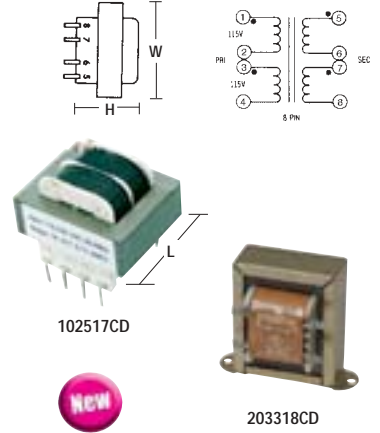

Quick-Connect Power Transformers

- Quick-connect transformers are bobbin wound for smaller size and reduced electrostatic shielding requirements
- Terminals: quick connect, solder
- Input voltage: 115/230VAC, 50-60Hz

Part Number	Mfr. Cross Ref. No.	Triad Cross	Fig.	Input Voltage	Output Voltage	VA Cap	Size of Connect	Dimensions			Wt. (lbs.)	Pricing		
								L"	W"	H"		1	10	100
164110CD	241-3-10	F310	1	115VAC	10VCT @ 0.25A	2.4	0.187"	.59	1.45	2.00	0.2	\$4.95	\$4.39	\$3.69
104387CD	XFR1225Q	FD612	2	115/230VAC	12.6VCT @ 2.5A	31.5	0.187"	1.75	2.33	2.00	1.3	11.95	10.79	9.69
104408CD	XFR1635Q	FD716	2	115/230VAC	16VCT @ 3.5A	56.0	0.187"	2.00	2.70	2.30	1.8	12.95	11.69	10.49
101864CD	XFR2424Q	FD724	2	115/230VAC	24VCT @ 2.4A	57.6	0.187"	1.87	2.70	2.25	1.7	11.95	10.79	9.69
221364CD	P-8663	F193U	1	117VAC	24VCT @ 4A	96.0	0.187"	2.81	3.13	3.81	4.0	18.95	17.85	14.95
221410CD	P-8666	F226U	1	117VAC	24VCT @ 12A	288.0	0.187"	4.63	3.75	4.63	11.2	41.95	39.15	29.85
104416CD	XFR3615Q	FD736	2	115/230VAC	36VCT @ 1.5A	54.0	0.187"	1.90	2.70	2.30	1.8	9.95	8.99	8.09

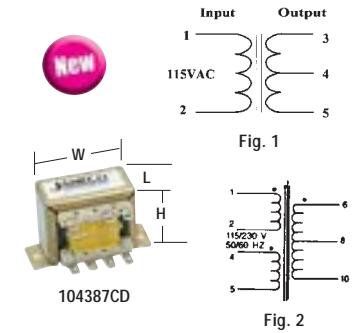

115VAC and 115/230VAC Power Transformers

Power transformers have both single and dual-voltage input and center-tapped outputs. This makes them the perfect choice for power supply design or for use in transformer, rectifier, and filter circuits.

- Primary: 115VAC or 115/230VAC, 50-60Hz

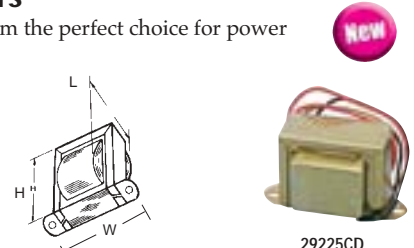
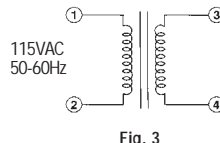
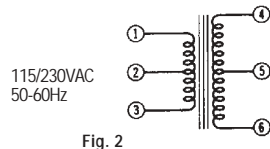
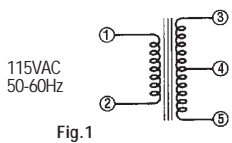

Part Number	Mfr. Cross Ref. No.	Triad Cross	Primary		VA Cap	Secondary			Lead Type	Fig.	Dimensions			Wt. (lbs.)	Pricing				
			Color Code	Color Code		Voltage	Color Code	Color Code			L"	W"	H"		1	10	100		
102162CD	XFR6102	F314X	Black	Yellow*	Red	7.6	6.3VCT @ 1.2A	White	Black*	White	Wire	2	1.56	1.96	1.67	0.8	\$8.49	\$7.65	\$6.89
105523CD	XFR0910	—	Black	White*	Red	9.0	9VCT @ 1A	Blue	Black*	Blue	Wire	2	1.79	1.96	1.66	0.7	6.95	6.25	5.59
221401CD	P-8391	F216X	Black	—	Black	4.2	12VAC @ 0.35A	White	—	White	Wire	3	1.38	2.38	1.38	0.4	5.95	5.59	4.69
221399CD	P-8657	F218X	Black	—	Black	24.0	12VAC @ 2A	White	—	White	Wire	3	2.13	3.25	2.00	1.3	9.15	8.49	7.15
221356CD	P-8658	F219X	Black	—	Black	48.0	12VAC @ 4A	White	—	White	Wire	3	2.25	4.00	2.63	2.3	12.95	11.95	9.95
29225CD	XFR122	F44X	Yellow	—	Yellow	25.2	12.6VCT @ 2A	Blue	Red*	Black	Wire	1	2.12	2.33	1.96	1.5	9.95	8.99	8.09
102154CD	XFR1220	F344X	Black	Yellow*	Red	25.2	12.6VCT @ 2A	White	Black*	White	Wire	2	2.35	2.32	1.97	1.5	10.95	9.89	8.89
149770CD	XFR1240	F3181U	Black	Red*	Yellow	50.4	12.6VCT @ 4A	White	Black*	White	Wire	2	2.45	2.70	2.24	2.2	12.95	11.69	10.49
102120CD	XFR124	F181U	Black	—	Black	50.4	12.6VCT @ 4A	White	Black*	White	Wire	1	2.53	3.08	2.61	2.7	12.95	11.69	10.49
105531CD	XFR1810	—	Blue	Red*	Black	18.0	18VCT @ 1A	Yellow	Black*	Yellow	Wire	2	2.32	2.05	1.90	1.2	6.95	4.55	3.55
149956CD	XFR1820	—	Black	Red*	Yellow	36.0	18VCT @ 2A	White	Black*	White	Wire	2	2.26	2.66	2.28	1.8	8.95	7.95	6.95
221381CD	P8396	—	Black	—	Black	9.6	24VCT @ 0.4A	White	Black*	White	Wire	1	1.63	2.8	1.5	0.6	7.25	6.69	5.59
102111CD	XFR2410	F346X	Black	Yellow*	Red	24.0	24VCT @ 1A	White	Black*	White	Wire	2	2.22	2.33	1.97	1.5	8.95	8.09	7.25
221372CD	P-8662	F192X	Black	—	Black	48.0	24VCT @ 2A	White	Black*	Ehite	Wire	1	2.38	4.00	2.62	2.3	11.95	10.95	9.19
112512CD	XFR242N	F229X	Black	—	Black	48.0	24VAC @ 2A	White	—	White	Wire	3	1.75	2.75	2.25	1.8	9.79	8.85	7.95
99653CD	XFR242	—	Red	—	Red	49.2	24.6VCT @ 2A	Blue	Yellow*	Blue	Wire	1	2.44	2.70	2.30	2.5	10.95	9.89	8.89
102103CD	XFR2520	F341X	Black	White*	Red	50.4	25.2VCT @ 2A	Orange	Black*	Orange	Wire	2	2.45	2.67	2.26	2.8	14.95	13.49	12.15
149796CD	XFR2820	F3185U	Black	Red*	Yellow	56.0	28VCT @ 2A	White	Black*	White	Wire	2	2.45	2.70	2.24	2.3	12.95	11.69	8.59

* Center tap





6VAC/9VAC Dual Output Power Transformer

12VA

- Input voltage: 120VAC
- Output voltage: 6VAC @ 500mA center tap (blue wires); 9VAC @ 1A center tap (yellow wires)
- Size: 2.1"L x 3.2"W x 2.0"H • Weight: 1.3 lbs.



Part No.	Mfr. Cross Ref. No.	1	10	100
183089CD	YS57H-099FAA	\$5.95	\$5.35	\$4.29

120VAC to 120VAC Isolation Transformer

300VA

- Input voltage: 120VAC @ 60Hz
- Input connector: 5.5" cord with 2-prong plug
- Output voltage: 120VAC @ 2.5A (isolated)
- Size: 4.2"H x 3.2"W x 4.6"D • Weight: 7.0 lbs.



Part No.	Mfr. Cross Ref. No.	1	10	100
181315CD	ITR300	\$39.95	\$35.99	\$32.39

EMI Suppression Cores with Case

Reduce Electro Magnetic Interference (EMI) with a snap of these suppression cores around a power cord or data cord. Easy to install and an affordable way to reduce EMI without redesigning your product.



Part No.	Size (OutDia. x InDia. x L)	1	10	100
218173CD	.64" x .20" x 1.15"	\$.99	\$.89	\$.79
217841CD	.78" x .34" x 1.40"	1.45	1.29	1.15

110VAC Variable AC Transformer

320VA

- Input voltage: 110VAC @ 60Hz (using pin 1-2) 110VAC @ 50Hz (using pin 1-4)
- Matching input/output terminals: P/N 103667CD and 109111CD (disconnect .25" solderless terminals), pg 123
- Maximum current: 2.5A • Panel mount
- Size: 2.8"Dia. x 2.1"H • Shaft length: 0.5"
- Weight: 2.5 lbs. • One-year warranty



Includes: 3 disconnect .25" solderless terminals

Part No.	Description	1	10	50
149323CD	320VA variable	\$53.95	\$48.59	\$43.75

110VAC Variable AC Transformer

550VA

- Input voltage: 110VAC @ 60Hz
- Output voltage: 0-140VAC
- Rated current: 5A • Panel mount
- Input/output terminals: binding post with 0.188" diameter post
- Size: 4.3"Dia. x 4.0"H
- Weight: 6.8 lbs. • One-year warranty



SALE

Part No.	Description	1	10	50
152936CD	550VA variable	\$64.95	\$58.49	\$52.65

AEEC 110VAC Variable AC Transformers

- Input voltage: 110VAC @ 60 Hz
- Power: 500 or 2000VA
- Output voltage: 0 to 130VAC
- Output analog voltmeter
- Input conn.: 3-prong plug w/ 5' cord
- Output conn.: 3-prong outlet type
- Lighted on/off power switch

169640CD: • 5A @ 250V fuse
 • Size: 8.3"L x 6.5"W x 7.0"H
 • Weight: 15.6 lbs.

169658CD: • 20A @ 250V fuse
 • Size: 9.8"L x 8.0"W x 7.0"H • Weight: 26.5 lbs.



Part No.	Description	1	10	50
169640CD	500VA transformer	\$84.95	\$76.49	\$68.85
169658CD	2000VA transformer	124.95	112.49	101.25

Variable AC Transformers

- Input: 110VAC or 220VAC
- Power: 500-2000VA
- Output: 0-240VAC
- Banana/screw input terminals
- Universal US/European output plugs
- Lighted on/off power switch

SALE



Part No.	Fuse	Size (L" x W" x H")	Wt. (lbs.)
121275CD	3A/250V (P/N 69438CD)	5.3 x 7.3 x 7.0	10.4
129007CD	5A/250V (P/N 10401CD)	9.4 x 6.5 x 7.7	14.8
152581CD	10A/250V (P/N 69462CD)	9.0 x 7.0 x 7.7	19.8

Part No.	Description	1	10	50
121275CD	500VA transformer	\$79.95	\$69.95	\$62.95
129007CD	1000VA transformer	164.95	148.49	133.65
152581CD	2000VA transformer	174.95	158.45	139.95

Opening an account is easy!!

Corporate Customers

Call 1-800-831-4242
for details today.

Power Entry Filters and AC Plug Connectors



Fig. 1 (146907CD)

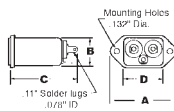

Fig. 2 (Solder Terminals)

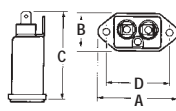

Fig. 3 (Fast-on Terminals)



Fig. 4 (210913CD)

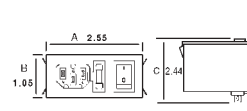

Fig. 5 (Cut out)

SALE

Fig. 6 (203140CD)



Fig. 7 (Male)



Fig. 8 (Female)



Fig. 9 (173770CD)



Fig. 10 (117444CD)



Fig. 11 (184903CD)

Part Number	Mfr. Cross Ref. No.	Corcom Cross	Description	Fig.	Current (A)	Voltage (VAC)	Terminals	Agency Approvals	Terminal Size	Dimension (Inches)				Pricing			
										A	B	C	D	1	10	100	500
146907CD	03DENG3B*	3EF1	Power entry filter (snap-in)	1	3	250	fast-on	UL/CSA/VDE	.25"	1.25	0.95	2.23	N/A	\$4.95	\$4.49	\$3.59	\$2.69
150615CD	03AC1	3EF1	Power entry filter, straight (flanged)	2	3	250	solder	UL/CSA/VDE	.16"	1.89	0.88	2.58	1.58	6.95	6.29	5.65	5.09
42454CD	06AC1	6EF1	Power entry filter, straight (flanged)	2	6	250	solder	UL/CSA/VDE	.16"	1.96	0.88	2.06	1.58	7.95	7.19	6.45	5.85
165016CD	SUP-J15G-E-2		Power entry filter, straight (flanged)	2	15	250	solder	UL/CSA/VDE	.16"	1.89	0.88	2.18	1.58	5.95	5.39	4.85	4.35
40601CD	03AE1*	3EF1F	Power entry filter, fused w/ switch (flanged)	3	3	250	fast-on	UL/CSA/VDE	.25"	1.97	0.90	2.16	1.58	7.49	6.69	5.99	5.39
63132CD	06AE1	6EF1F	Power entry filter, straight (flanged)	3	6	250	fast-on	UL/CSA/VDE	.16"	1.96	0.88	2.06	1.58	6.95	6.29	5.65	5.09
217744CD	10AE1	10EF1F	Power entry filter, straight (flanged)	3	10	250	fast-on	UL/CSA/VDE	.25"	1.96	0.89	2.23	1.58	9.95	8.95	8.09	7.29
220206CD	10GEEG3E		Power entry filter, straight (flanged)	3	10	250	solder	UL/CSA/VDE	.16"	1.96	0.87	2.16	1.58	8.49	7.65	6.89	6.19
210913CD	01GEEW3E		Power entry filter, straight (flanged)	4	1	250	wire	UL/CSA/VDE	4.1"	2.05	0.99	1.78	1.58	5.95	5.49	4.95	4.49
212206CD	A6-12S10E		Power entry filter, fused w/ switch (snap-in)	5	6	250	fast-on	UL/CSA/VDE	.25"	2.55	1.05	2.44	N/A	9.95	8.95	7.95	6.95
203140CD	F6-12S10E1		Power entry filter, fused w/ switch (snap-in)	6	6	250	fast-on	UL/CSA/VDE	.25"	2.55	1.05	2.82	N/A	11.95	10.95	9.95	8.95
147109CD	42R02		AC power inlet (male) snap-in	7	15	250	fast-on	UL/CSA/VDE	.25"	1.22	0.94	1.13	N/A	.26	.23	.21	.19
16651CD	JR101		AC power inlet (male) flanged	7	15	250	fast-on	UL/CSA/VDE	.187"	1.96	0.89	1.07	1.58	.79	.71	.57	.41
147900CD	P0707*		AC power inlet (male) flanged	7	15	250	solder	UL/CSA/VDE	.16"	1.96	0.89	1.04	1.58	.75	.68	.59	.55
218288CD	0708-1-CQ		AC power outlet (female) flanged	8	10	250	fast-on	UL/CSA/VDE	.189"	1.97	1.14	1.27	1.58	.89	.79	.72	.65
173770CD	6200-21		AC power inlet (male) fused (flanged)	9	10	250	fast-on	UL/CSA/VDE	.136"	1.73	1.34	1.00	1.41	.79	.69	.59	.39
117444CD	0717*		AC power inlet (male) fused (snap-in)	10	10	250	fast-on	UL/CSA/VDE	.187"	1.18	1.30	1.21	N/A	1.95	1.79	1.59	1.45
184903CD	42R363152IOU		AC power inlet (male) w/ switch (snap-in)	11	15	250	fast-on	UL/CSA/VDE	.25"	1.30	1.58	1.42	N/A	.40	.37	.33	.30

* Manufacturer may vary

1 High normal mode rejection

2 Includes spare fuse holder - Fuse type 5mm x 20mm (250V)

- Molded connectors
- Excellent resistance to jacket abrasion
- Temperature: -20°C to +60°C
- Voltage rating: 300 volts

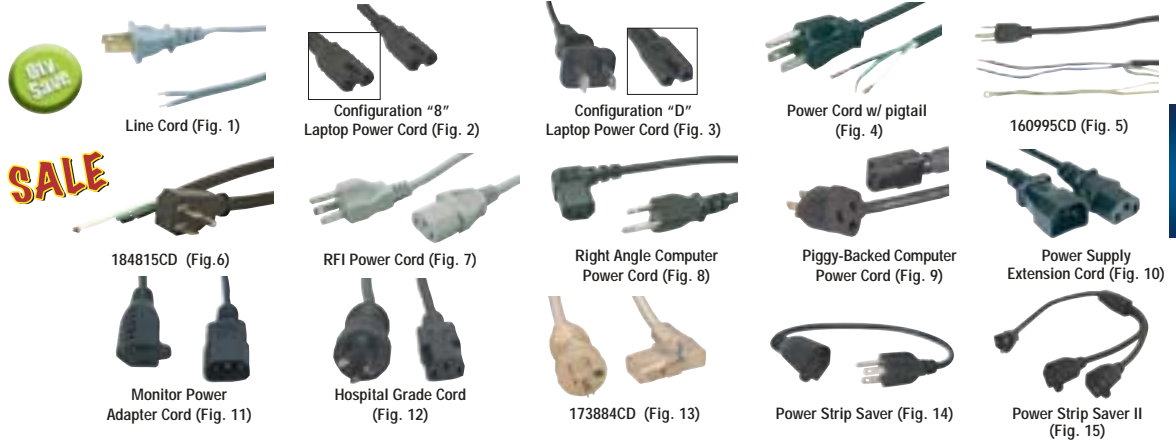

AWG	Volts	Amps	VA
18	125	10	1250
16	125	12	1500
14	125	15	1875

SALE



Part Number	Mfr. Cross Reference No.	Description	Weight (lbs.)	Agency Approvals	Plug Fig.	Length	Color	AWG	Cord Type*	Pricing			
										1	10	100	250
152186CD	17106BG	2-conductor power cord with pigtail	.20	UL/CSA	1	6'	Beige	18/2	SPT-2	\$1.09	\$.98	\$.78	\$.59
124433CD	ST008	2-conductor power cord with pigtail	.16	UL/CSA	1	6'	Black	18/2	SPT-2	1.15	.99	.89	.79
42041CD	17106	2-conductor power cord with pigtail with strain relief	.25	UL/CSA	1	6'	Black	18/2	SPT-2	1.15	.99	.89	.79
146309CD	PC182J6	2-conductor power cord with pigtail (round)	.31	UL/CSA	1	6'	Black	18/2	SJT	1.09	.98	.78	.59
189587CD	VW-1	2-conductor "8" style power cord for laptops and power supplies	.30	UL/CSA	2	6'	Black	18/2	SPT-2	2.95	2.49	2.15	1.79
200791CD	LL114039	2-conductor "D" style power cord for laptops and power supplies	.30	UL/CSA	3	6'	Black	18/2	SPT-2	2.95	2.49	2.15	1.59
38009CD	17237	3-conductor power cord with pigtail	.31	UL/CSA	4	6'	Gray	18/3	SVT	2.49	2.25	1.95	1.75
173809CD	17405	3-conductor power cord with pigtail	.39	UL/CSA	4	6'	Gray	18/3	SJT	2.95	2.49	2.25	1.95
37997CD	17236	3-conductor power cord with pigtail	.30	UL/CSA	4	6'	Black	18/3	SVT	2.79	2.32	2.11	1.99
159409CD	17405B	3-conductor power cord with pigtail	.37	UL/CSA	4	6'	Black	18/3	SJT	2.59	2.15	1.95	1.79
38025CD	17238	3-conductor power cord with pigtail	.39	UL/CSA	4	8'	Black	18/3	SVT	3.29	2.75	2.45	2.25
102007CD	17535B	3-conductor power cord with pigtail	.49	UL/CSA	4	10'	Black	18/3	SVT	3.25	2.75	2.49	2.25
196285CD	LL40378	3-conductor power cord with pigtail	.80	UL/CSA	4	10'	Black	16/3	SJT	3.49	2.79	2.09	1.49
166924CD	17516	3-conductor power cord with pigtail	.67	UL/CSA	4	6' 7"	Black	14/3	SJT	3.95	3.55	3.19	2.79
100271CD	17629B	3-conductor power cord with pigtail	.88	UL/CSA	4	9'	Black	14/3	SJT	4.25	3.55	3.25	2.89
160995CD	17720	3-conductor power cord with pigtail (shielded)	.44	UL/CSA	5	8'	Black	18/3	SVT	2.95	2.65	2.39	2.15
184815CD	17629BR	3-conductor right angle power cord with pigtail	.77	UL/CSA	6	7'	Black	14/3	SJT	2.15	1.89	1.69	1.55
103747CD	17248	3-conductor detachable power supply cord	.34	UL/CSA	7	6'	Gray	18/3	SVT	3.59	3.09	2.75	2.65
213874CD	17660BG	3-conductor detachable power supply cord (shielded)	.40	UL/CSA	7	6'	Beige	18/3	SVT	3.59	3.25	2.95	2.65
38041CD	17249	3-conductor detachable power supply cord	.37	UL/CSA	7	6'	Beige	18/3	SVT	3.49	3.15	2.79	2.49
38050CD	17250	3-conductor detachable power supply cord	.36	UL/CSA	7	6'	Black	18/3	SVT	3.75	3.25	2.75	2.49
161761CD	17742	3-conductor detachable power supply cord (shielded)	.40	UL/CSA	7	6'	Black	18/3	SVT	3.95	3.59	3.19	2.89
132118CD	17500	3-conductor detachable power supply cord	.44	UL/CSA	7	6'	Black	18/3	SJT	4.49	4.05	3.65	3.29
117583CD	17502	3-conductor detachable power supply cord	.37	UL/CSA	7	8'	Gray	18/3	SVT	3.49	3.15	2.79	2.49
171096CD	17758	3-conductor detachable power supply cord	.60	UL/CSA	7	8'	Black	18/3	SJT	3.95	3.55	3.19	2.89
102023CD	17501V	3-conductor detachable power supply cord	.55	UL/CSA	7	10'	Black	18/3	SVT	3.95	3.39	3.09	2.79
192727CD	17501J	3-conductor detachable power supply cord	.64	UL/CSA	7	10'	Black	18/3	SJT	3.95	3.59	2.89	2.15
190625CD	37805	3-conductor detachable power supply cord (shielded)	.75	UL/CSA	7	10'	Beige	18/3	SJT	3.95	3.59	2.89	2.15
163361CD	6952299	3-conductor detachable power supply cord	.33	UL/CSA	7	14'	Black	18/3	SJT	5.39	4.85	4.39	3.95
159361CD	17602	3-conductor detachable power supply cord	.57	UL/CSA	7	6'	Black	16/3	SJT	3.79	3.15	2.79	2.49
142607CD	17502	3-conductor detachable power supply cord (shielded)	.63	UL/CSA	7	6'	Black	16/3	SJT	4.19	3.79	3.39	3.05
125541CD	17504	3-conductor detachable power supply cord	.71	UL/CSA	7	6' 7"	Black	14/3	SJT	4.95	4.45	3.55	2.69
117356CD	8120-6177	3-conductor detachable right angle power supply cord	.41	UL/CSA	8	6'	Gray	18/3	SVT	3.95	3.59	3.25	2.89
38076CD	17250R	3-conductor detachable right angle power supply cord	.54	UL/CSA	8	6'	Black	18/3	SVT	3.49	3.15	2.85	2.55
173251CD	17250RS	3-conductor detachable right angle power supply cord (shielded)	.40	UL/CSA	8	6'	Black	18/3	SVT	3.29	2.99	2.69	2.39
177383CD	17507	3-conductor detachable right angle power supply cord	.66	UL/CSA	8	10'	Black	18/3	SJT	3.95	3.59	2.89	2.15
84937CD	17669-6	3-conductor detachable piggy backed computer power cord	.47	UL/CSA	9	6'	Black	18/3	SJT	6.95	6.29	5.05	3.79
28468CD	PEC	3-conductor computer power supply extension cord	.36	UL/CSA	10	6'	Black	18/3	SVT	4.39	3.95	3.59	3.25
121291CD	PEC2	3-conductor computer power supply extension cord	.55	UL/CSA	10	8'	Black	18/3	SJT	3.95	3.59	2.89	2.19
175855CD	PECUL10	3-conductor computer power supply extension cord	.53	UL/CSA	10	10'	Black	18/3	SVT	2.49	2.29	1.85	1.39
177447CD	MPC1	3-conductor monitor power adapter cord	.16	UL/CSA	11	1'	Black	18/3	SVT	2.95	2.49	2.15	1.79
26382CD	MPC6	3-conductor monitor power adapter cord	.40	UL/CSA	11	6'	Black	18/3	SVT	2.19	1.95	1.79	1.59
196277CD	E55333	3-conductor power cord w/ hospital grade male (green dot)	.56	UL/CSA	12	6' 6"	Gray	18/3	SJT	2.95	2.69	2.15	1.59
132011CD	17006G	3-conductor power cord w/ hospital grade male (green dot)	.82	UL/CSA	12	10'	Gray	16/3	SJT	8.45	7.65	6.15	4.59
115078CD	17006	3-conductor power cord w/ hospital grade male (green dot)	.84	UL/CSA	12	10'	Black	16/3	SJT	8.95	8.09	7.25	6.55
173884CD	3472WJ698G	3-conductor power cord w/ hospital grade male rt ang (green dot)	.85	UL/CSA	13	9'	Gray	16/3	SJT	7.95	7.19	5.75	4.35
199777CD	PSS-1	3-conductor power cord (power strip saver)	.16	UL/CSA	14	1'	Black	18/3	SVT	1.69	1.55	1.39	1.25
208338CD	SY0527BG	3-conductor power cord (power strip saver)	.16	UL/CSA	14	1'	Beige	18/3	SVT	1.69	1.45	1.09	1.09
208346CD	GPR-2006	3-conductor power cord ("Y" type power strip saver)	.38	UL/CSA	15	2'	Black	18/3	SVT	2.89	2.65	2.35	2.15

* Thermoplastic Cord Jacket Type: SPT-2 (Flat): Junior duty; SVT (Round): Light service; SJT (Round): Junior service



Voice/Data Coupling Transformer

- Pri./Sec. impedance: 600Ω
- Turns ratio: ±2%
- Resistance (Pri./Sec.): 63Ω/88Ω
- Frequency response: 300-3500Hz (±0.5dB)

PREM

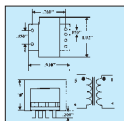

Part No.	Product No.	1	10	100
164128CD	SPT115	\$1.05	\$.94	\$.85

Modem Coupling Transformers

- Insulation resistance: 100MΩ
- Vacuum wax impregnated
- ±20% impedance matching
- ±20% DC resistance matching
- Core type: EI-14
- Hipot tested: 1000VAC

SALE

125356CD

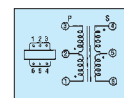
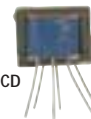

125356CD

Part No.	Mfr. Cross Reference No.	Impedance (Ω)		Resistance (Ω)		Pricing		
		Primary	Secondary	Primary	Secondary	1	10	100
125356CD	XFR6006A14	600CT	600CT	65	55	\$1.29	\$1.18	\$1.08
205962CD	60-282-0	1.2KCT	8	45	1.5	1.69	1.49	1.39

For Inductors see page 91

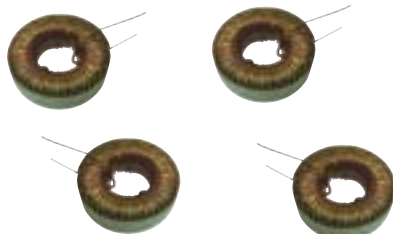

Modem Coupling Transformers

- Dielectric strength: 1250VAC



141621CD



SALE

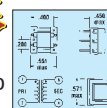

141621CD

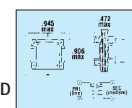

117760CD

Part Number	Mfr. Cross Ref. No.	Impedance (Ω)		Resistance (Ω)		Insertion Loss	Pricing		
		Primary	Secondary	Primary	Secondary		1	10	100
141621CD	671-8255	600	600	46.5	67.6	1.25dB @ 1kHz	\$1.95	\$1.79	\$1.35
199540CD	671-8079	600	301	150	150	3.00dB @ 1kHz	1.65	1.49	1.35
117760CD	671-8014	600	600	108	120	2.50dB @ 1kHz	2.15	1.95	1.75
206391CD	TTC-105	600	600	71	117	2.50dB max. @ 800Hz to 3.5kHz	2.95	2.59	1.95

See pages 46 - 48 for Current Sensing Transformers, Power Transformers and Variable Transformers

International Step-Up/Step-Down Auto and Isolation Transformers

- Wide selection to meet your power requirements

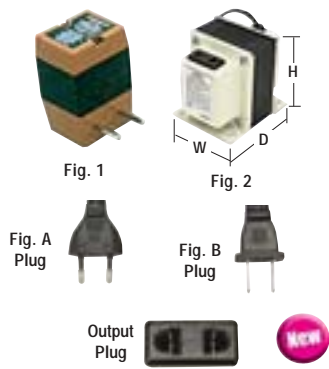

Part Number	Mfr. Cross Ref. No.*	Fig.	Type	Primary Voltage	Secondary Voltage	Power (VA)	Dimensions			Weight (lbs.)	Pricing		
							H"	W"	D"		1	10	100
99573CD	AC110V50	1/A	auto	220VAC	110VAC	50	2.50	1.63	1.33	0.7	\$9.95	\$8.99	\$8.00
85016CD	AC110V300	2/A	auto	220VAC	110VAC	300	3.50	3.05	3.95	4.8	27.95	24.95	22.49
111851CD	AC110V500	2/A	auto	220VAC	110VAC	500	3.99	3.60	4.84	8.5	34.95	31.49	28.95
221250CD	GSD-1000	2/A	auto	220VAC	110VAC	1000	4.63	3.81	6.06	17.0	83.95	74.95	60.89
142906CD	AC110V1500	2/A	auto	220VAC	110VAC	1500	5.25	4.50	5.75	15.2	79.95	71.95	64.95
99477CD	AC220V50	1/B	auto	110VAC	220VAC	50	2.50	1.63	1.33	0.7	8.95	8.09	7.25
221233CD	P8638	2/B	auto	110VAC	220VAC	125	3.13	2.50	3.00	3.0	28.95	26.55	22.35
85008CD	AC220V300	2/B	auto	110VAC	220VAC	300	3.50	3.05	3.95	4.8	27.95	24.95	22.49
221217CD	P8689	2/B	auto	110VAC	220VAC	1000	4.63	3.75	6.13	17.0	61.95	57.55	43.85
221313CD	G1SD-500	2/A	isolation	220VAC	110VAC	500	4.69	3.75	6.00	16.0	78.95	69.95	57.49
222092CD	G1SD-1000	2/A	isolation	220VAC	110VAC	1000	5.38	4.38	8.13	31.0	149.95	121.95	112.79
221348CD	G1S-250	2/B	isolation	110VAC	110VAC	250	4.69	3.75	4.38	9.0	68.95	63.49	49.65
221330CD	G1S-500	2/B	isolation	110VAC	110VAC	500	4.69	3.75	6.00	16.0	78.95	69.95	57.49
221321CD	G1S-1000	2/B	isolation	110VAC	110VAC	1000	5.38	4.38	8.13	31.0	149.95	121.95	112.79

* Manufacturer may vary

International Power Cords

- 3-conductor detachable power cords
- Voltage rating: 300 volts
- Excellent resistance to jacket abrasion
- BS1: British Standard Institution



SALE

Cord Configuration Chart – End 1



A

Cord Configuration Chart – End 2



117911CD (Fig. 1)



174633CD (Fig. 2)

Part Number	Mfr. Cross Reference No.*	Country	Agency Approvals	Cord Plug Fig.		Length	Cord Color	Conductors	Cord Type	Pricing			
				End 1	End 2					1	10	100	250
117911CD	PCVDE-6B	Europe	All in Fig. 3	A	1	6 ft.	Black	3/.75mm ²	H05VVF	\$5.49	\$4.95	\$4.45	\$4.05
138270CD	H05VVF	Europe	All in Fig. 3	A	1	6 ft.	Beige	3/1.0mm ²	H05VVF/HAR	3.05	2.79	2.55	2.29
174633CD	21071H5182	UK/Ireland	BSI	A	2	8 ft.	Black	3/1.0mm ²	H05VVF	6.95	6.29	5.05	3.79

* Manufacturer may vary

European Agency Approvals

Germany	VDE	
Austria	OVE	
Belgium	CEBEC	
Denmark	DEMKO	
Finland	FIMKO	
France	LCIE	
Netherlands	KEMA	
Norway	NEMKO	
Sweden	SEMKO	
Switzerland	SEV	

Fig. 3



Phone 1-800-831-4242

Fax 1-800-237-6948

Order Anytime 24x7x365

Online www.Jameco.com

AC-to-DC Regulated Linear Table-Top Power Supplies

See page 50 for International Power Cords



211060CD



116089CD



153752CD



107326CD



163969CD

SALE



Female



Male



DIN M



Stripped



Molex

Part Number	Mfr. ▲	Mfr. Cross Reference No. ▲	Output		Input VAC@Hz	Output Plug/Connector ID x OD/Plug Type/Polarity F = female; M = male	Pwr. Ind.	Color	Size (L" x W" x H")	Cords* (DC/AC)	Wt. (lbs.)	Agency Approvals	Pricing				
			Power (W)	Volts (VDC)/ Current (A)									1	10	50	100	
2-Wire AC Input																	
211060CD	Pacific Data	DV-51AAT	5	+5/1	120@60	2.1mm x 5.5mm rt angle F 2	No	Black	3.4 x 2.7 x 2.2	6'6"	1.7	UL/CSA	\$12.95	\$11.69	\$10.55	\$9.49	
116089CD	Atari	C070042	5	+5/1	115@60	7-pin DIN M	No	Black	3.4 x 2.7 x 2.3	6'6"	1.6	UL	8.39	7.55	6.05	4.55	
103173CD	Jameco	JE9100	9	+5/0.6, ±12/0.25	120@50-60	5-pin DIN M	No	Black	4.8 x 3.1 x 2.5	6'6"	2.3	UL/CSA	20.95	18.89	16.99	14.95	
174844CD	Jameco	DCR2410F12	24	+24/1	120@60	2.1mm x 5.5mm F 2	No	Black	4.4 x 3.0 x 2.5	6'6"	2.6	—	16.95	15.29	13.75	12.39	
174852CD	Jameco	DCR2410F52	24	+24/1	120@60	2.5mm x 5.5mm F 2	No	Black	4.4 x 3.0 x 2.5	6'6"	2.7	—	14.95	12.95	10.95	9.95	
173665CD	Skyнет	DND-3005	15	+30/0.5	120-127@60	2.5mm x 5.5mm F 2	No	Black	3.0 x 2.5 x 2.2	5'9"/3'2"	1.4	UL/CUL	13.29	11.99	9.59	7.24	
3-Wire AC Input																	
163969CD	Gatron	AH633N	3.75	+5/0.75	120@60	4-pin mini DIN M	No	Black	4.1 x 2.5 x 2.0	6'5/9"	1.5	UL/CSA	\$1.09	\$.98	\$.89	\$.81	
154624CD	Motorola	5712-305-4C3E †	5.6	+5/0.5, ±12/0.13	120@60	8-pin mini DIN M	No	Black	2.9 x 2.6 x 1.9	6'	1.2	UL/CSA	11.49	10.39	8.29	6.29	
153752CD	Skyнет	LVT-T022	8	+5/1.5, -5/0.1	115/230@50-60	5-pin mini DIN M	No	Black	5.5 x 2.9 x 1.5	6'2"	1.1	UL/CSA/TUV	12.95	11.69	9.35	6.99	
155651CD	Globtek	TR2V100MD8	12.2	+5/1, ±12/0.3	120@60	8-pin mini DIN M	No	Black	4.5 x 3.0 x 2.5	6'6"	2.6	UL	9.69	8.69	7.79	6.99	
203596CD	Elpac	WM150	15	+5/3	120@60	5-pin DIN M	No	Black	5.4 x 3.9 x 2.6	6'6"	3.5	UL/CSA	12.35	11.25	10.19	9.19	
107326CD	Kelltron	MPC2562	15.2	+5/2, +26/0.2	115@60	3-pin Molex F	No	Black	7.0 x 4.9 x 2.5	6'3/5"	3.1	UL	3.15	2.85	2.59	2.35	

† Wall-Mount * See accessory table-top power cord chart below when AC cord needed; refer to 1, 2 or 3 in Cord (DC/AC) column above for correct power cord ▲ Manufacturer and Product Number may vary

AC-to-DC Unregulated Wall Mount & Table-Top Power Supplies

SALE

Part Number	Mfr. ▲	Mfr. Cross Reference No. ▲	Output		Input VAC@Hz	Output Plug/Connector ID x OD/Plug Type/Polarity F = female; M = male	Pwr. Ind.	Color	Size (L" x W" x H")	Length Cords (DC/AC)	Wt. (lbs.)	Agency Approvals	Pricing				
			Power (W)	Volts (VDC)/ Current (A)									1	10	50	100	
2-Wire AC Input																	
190051CD	APS	APS48EA114	10	+7/1.5	120@60	2.5mm x 5.5mm female 2	No	Black	3.4 x 2.3 x 1.9	6'6"	1.9	UL/CUL	\$9.95	\$8.99	\$7.19	\$5.39	
136565CD	Jameco	DDC1210P	12	+12/1.0	120@60	Stripped & Tinned	No	Black	3.2 x 2.2 x 1.9	6'6"	1.2	—	13.95	12.59	11.39	10.19	
191898CD	Brother	A81807DM+	12.6	+18/0.7	127@60	2.1mm x 5.5mm female 1	No	Black	4.2 x 3.1 x 2.5	6'6"	2.6	—	3.85	3.49	3.09	2.79	
203511CD	LZR	AD1590 †	13.5	+15/0.9	120@60	6-pin mini DIN M	No	Black	2.6 x 2.3 x 1.9	6'	1.0	UL/CSA	4.29	3.89	3.55	3.25	
140880CD	Jameco	DC1215ST	18	+12/1.5	120@60	Stripped & Tinned	No	Black	3.1 x 2.1 x 1.9	6'6"	1.5	UL	10.95	9.95	8.95	7.95	
189211CD	ACI World	57-12-1500D †	18	+12/1.5	120@60	8-pin mini DIN M	No	Black	3.4 x 2.6 x 2.2	3'4"	1.7	UL/CUL	4.95	4.49	3.59	2.69	
220919CD	Jameco	EFU135170	23	+13.5/1.7	120@60	2.1mm x 5.5mm F 1	No	Black	3.4 x 2.7 x 2.1	6'6"	—	UL/CUL	17.49	16.35	14.39	13.69	
143714CD	—	DC1220F1	24	+12/2.0	120@60	2.1mm x 5.5mm female 2	No	Black	3.8 x 2.8 x 2.3	6'6"	2.2	—	14.95	13.49	12.19	10.99	
143722CD	Jameco	DC1220F5	24	+12/2.0	120@60	2.5mm x 5.5mm female 2	No	Black	3.8 x 2.8 x 2.3	6'6"	2.2	—	12.95	11.69	10.55	9.49	
143731CD	—	DC1220M3	24	+12/2.0	120@60	3.5mm M 2	No	Black	3.8 x 2.8 x 2.3	6'6"	1.9	—	12.95	11.49	10.49	9.49	
203182CD	Brother	A71222D	25	+11.5/2.2	120@60	2.1mm x 5.5mm female 1	No	Black	4.1 x 2.8 x 2.2	6'6"	2.0	UL/CSA	12.95	11.49	10.49	9.49	
139096CD	Jameco	DC2412F1	29	+24/1.2	120@60	2.1mm x 5.5mm female 2	No	Black	4.4 x 3.1 x 2.6	6'6"	2.5	—	14.95	13.49	12.15	10.95	
196947CD	Logitech	SCP60-201500	30	+20/1.5	120@60	2.1mm x 5.5mm female 2	No	Black	3.8 x 2.8 x 2.3	6'6"	1.2	UL/CUL	8.69	7.79	6.99	6.29	
205920CD	Skyнет	DND-3012	30	+30/1.0	120-127@50-60	2.5mm x 5.5mm female 2	No	Black	4.0 x 2.9 x 2.5	6'6"	1.7	UL/CUL	12.95	11.49	10.49	9.49	
3-Wire AC Input																	
157956CD	Everglow	PS571812D	18	+12/1.5	120@60	2.5mm x 5.5mm female 2	No	Black	3.4 x 2.7 x 2.2	6'6"	2.0	UL	\$10.95	\$9.95	\$8.95	\$7.95	
196306CD	—	A51813D	23	+18/1.3	120@60	2.5mm x 5.5mm female 2	No	Black	3.6 x 2.4 x 2.0	6'6"	1.8	UL/CSA	12.95	11.69	9.34	7.04	

† Wall-Mount ▲ Manufacturer may vary



38041CD

38050CD

** Accessory Power Input Cords



189587CD

Part No.	Ref. No.**	Description	Color	AWG	Certification	Cord Length	Wt. (lbs.)	Cord Type	1	10	100	250
38041CD	1	3-conductor power cord	Beige	18/3	UL/CSA	6'	0.4	SVT	\$3.49	\$3.15	\$2.79	\$2.49
38050CD	2	3-conductor power cord	Black	18/3	UL/CSA	6'	0.4	SVT	3.75	3.25	2.75	2.49
189587CD	3	2-conductor power cord	Black	18/2	UL/CSA	6'	0.3	SPT	2.95	2.49	2.15	1.79



AC-to-DC Regulated Wall Transformers (Adapters)



We specialize in Wall Transformers – Call for additional OEM PRICING.



164101CD



171301CD



We will change any power plug (pg 59) on any DC wall transformer listed (100 pc. minimum).



Female



Male



Stripped



216442CD



174879CD

SALE

Polarity 1 \oplus \ominus \ominus (center negative)

Polarity 2 \ominus \ominus \oplus (center positive)



2-Wire AC Input

Part Number	Mfr. Cross Reference No. *	Output Rating		Output Plug ID x OD Plug Type / Polarity F = female; M = male	Input VAC @ Hz	Size (+0%-20%) H" x W" x D"	Case Color	Output Cord Length	Weight (lbs.)	Agency Approvals	Pricing			
		Voltage (VDC)	Current (mA)								1	10	50	100
164101CD	DCR505F12	5	500	2.1mm x 5.5mm F 2	120@60	2.8 x 2.0 x 1.6	Black	6'	0.6	UL/CSA	\$8.95	\$8.09	\$7.25	\$6.55
220935CD	DDU050060	5	600	2.1mm x 5.5mm F 1	120@60	2.7 x 2.2 x 1.9	Black	6'	0.8	UL/CUL	13.25	12.35	10.58	10.35
171301CD	JOD48U08	5	1000	2.1mm x 5.5mm F 2	120@60	3.1 x 2.9 x 2.0	Black	6'	1.0	UL/CUL	9.95	8.95	7.95	6.95
196411CD	DCR510F12V	5	1000	2.1mm x 5.5mm F 2	120@60	3.3 x 2.2 x 1.9	Ivory	6'	1.0	UL/CUL	10.95	9.89	7.95	5.95
225995CD	ADP-5DB	5	1000	2.5mm X 5.5mm F 2	100-120@50-60	2.5 x 1.8 x 1.1	Black	6'	0.2	UL	10.95	9.89	8.89	7.99
168604CD	RWP480505	5	1000	2.5mm x 5.5mm F 2	120@60	3.3 x 2.2 x 1.9	Black	6'	1.2	UL/CSA	10.95	9.89	8.89	7.99
216442CD	AO5C1-05MP	5	1600	2.5mm x 5.5mm F 2	100-240@50-60	2.2 x 1.8 x 1.1	Black	6'	0.4	UL/CUL/CE	12.95	11.65	10.49	9.49
196314CD	SYS10891005LW2	5	2000	2.1mm x 5.5mm F 2	100-120@60	2.9 x 1.9 x 1.6	Black	6'	0.4	UL/CSA/CE	12.95	11.69	9.35	7.05
189190CD	EPA101MU-05B	5	2000	2.5mm x 5.5mm F 1	100-240@50-60	2.9 x 2.8 x 1.3	Black	6'	0.4	UL/CUL	12.95	11.69	9.35	6.99
210892CD	EPA101MU	5	2000	2.5mm x 5.5mm F 2	100-240@50-60	3.2 x 2.4 x 1.3	Black	6'	0.4	UL/CUL	12.95	11.69	9.35	6.99
196470CD	WR92A2400CCP †	5	2400	2.1mm x 5.5mm F 2	100-240@50-60	3.2 x 2.2 x 1.9	Black	6'	0.5	UL/CSA	11.95	9.59	7.19	5.09
161541CD	WA15050R	5	2500	2.1mm x 5.5mm F 2	100-120@60	2.9 x 2.0 x 1.6	Black	6'	0.4	UL/CSA	11.69	10.55	9.49	8.55
190511CD	SADB-0885	6	200	2.1mm x 5.5mm F 2	115@60	2.6 x 1.8 x 1.5	Black	6'	0.4	UL/CUL	5.95	5.39	4.35	3.25
206148CD	DSA-0151A-06A	6	2000	2.1mm x 5.5mm F 2	100-120@60	3.1 x 2.1 x 1.4	Black	6'	0.4	UL/CUL	12.95	11.69	9.35	6.99
190529CD	AD9123	9	250	2.5mm x 5.5mm right angle F 2	120@60	2.5 x 2.0 x 1.6	Black	12'	0.5	UL/CSA	5.69	5.15	4.55	3.95
161550CD	WA15090R	9	1670	2.1mm x 5.5mm F 2	100-120@60	2.9 x 2.0 x 1.6	Black	6'	0.4	UL/CUL	11.95	10.38	9.08	8.65
162996CD	DCR1205F12	12	500	2.1mm x 5.5mm F 2	120@60	3.2 x 2.2 x 1.9	Black	6'	0.9	—	8.95	8.09	7.25	6.55
170245CD	DCR1210F12	12	1000	2.1mm x 5.5mm F 2	120@60	3.2 x 2.3 x 2.0	Black	6'	1.2	—	13.95	12.59	11.35	10.19
220898CD	DCU120020	12	1200	2.1mm x 5.5mm F 1	120@60	2.5 x 2.0 x 1.7	Black	6'	0.5	UL/CUL	7.39	6.89	5.95	5.79
183433CD	WA15-120	12	1250	2.5mm x 5.5mm F 2	100-120@60	3.0 x 1.6 x 2.5	Black	6'	0.4	UL/CUL	16.95	15.29	13.75	12.39
210809CD	SC102TA1200-B02	12	1500	2.1mm x 5.5mm F 2	100-240@50-60	2.9 x 2.0 x 2.6	Black	10'6"	0.6	UL/CUL	12.95	11.69	9.35	6.99
169391CD	LISD15B-P1J	15	1000	2.1mm x 5.5mm F 2	100-120@60	2.9 x 1.9 x 1.6	Black	6'	0.5	UL/CUL	11.95	10.38	9.08	8.65
224590CD	LISD15B-P1J	15	1000	2.1mm x 5.5mm F 2	100-120@60	3.2 x 2.2 x 1.3	Black	6'	0.5	UL/CSA	12.29	11.09	9.95	8.95
168487CD	KWM020188	18	1000	2.1mm x 5.5mm F 2	100-240@50-60	2.9 x 1.9 x 1.6	Black	6'	0.4	UL/CUL	17.95	16.19	14.55	13.09
174861CD	DCR2405F12	24	500	2.1mm x 5.5mm F 2	120@60	3.4 x 2.7 x 2.2	Black	6'	1.3	—	11.95	10.79	9.69	8.75
174879CD	DCR2405F52	24	500	2.5mm x 5.5mm F 2	120@60	3.4 x 2.7 x 2.2	Black	6'	1.3	—	11.95	10.79	9.69	8.75

† 3-wire AC input

* Manufacturer may vary

AC-to-DC Unregulated Wall Transformers (Adapters)



112070CD



155601CD



We will change any power plug (pg 59) on any DC wall transformer listed (100 pc. minimum).

Input: 120VAC @ 60Hz



Female



Male



Stripped



219651CD



101266CD

Polarity 1 \oplus \ominus \ominus (center negative)

Polarity 2 \ominus \ominus \oplus (center positive)

2-Wire AC Input

Part Number	Mfr. Cross Reference No. *	Output Rating		Output Plug ID x OD Plug Type / Polarity F = female; M = male	Size (+0%-20%) H" x W" x D"	Case Color	Output Cord Length	Weight (lbs.)	Agency Approvals	Pricing			
		Voltage (VDC)	Current (mA)							1	10	50	100
112070CD	DC502F5	5	225	2.5mm x 5.5mm F 2	1.9 x 2.2 x 2.0	Black	7'	0.3	UL/CSA	\$7.29	\$6.59	\$5.95	\$5.35
155601CD	DC510F1	5	1000	2.1mm x 5.5mm F 2	2.6 x 2.0 x 1.7	Black	6'	0.7	UL/CSA	4.95	4.29	3.85	3.55
219651CD	FE4823-050E120	5	1200	2.5mm x 5.5mm F 2	3.5 x 2.4 x 1.9	Black	6'	1.2	UL/CUL	8.95	7.95	7.25	6.55
119255CD	DC605F11	6	500	2.1mm x 5.5mm F 1	2.3 x 1.8 x 1.8	Black	6'	0.6	UL/CUL	3.95	3.59	3.25	2.89
101266CD	DC605F12	6	500	2.1mm x 5.5mm F 2	2.4 x 1.9 x 1.6	Black	6'	0.4	UL/CSA	3.95	3.59	3.25	2.89
15544CD	DC605M3	6	500	3.5mm M 2	2.4 x 1.9 x 1.6	Black	6'	0.4	UL/CSA	3.95	3.59	3.25	2.89

* Manufacturer may vary

AC-to-DC Wall Transformers continued on page 55 - 57

AC-to-DC Unregulated Wall Transformers (Adapters) *continued*

We specialize in Wall Transformers – Call for additional OEM PRICING.



We will change any power plug (pg 59) on any DC wall transformer listed (100 pc. minimum).

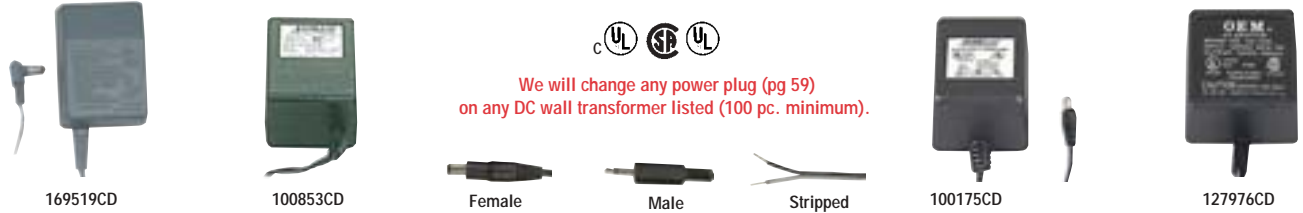

• Input: 120VAC @ 60Hz

SALE

2-Wire AC Input

Part Number	Mfr. Cross Reference No. *	Output Rating		Output Plug ID x OD Plug Type / Polarity F = female; M = male	Size (+0%-20%) H" x W" x D"	Case Color	Output Cord Length	Weight (lbs.)	Agency Approvals	Pricing			
		Voltage (VDC)	Current (mA)							1	10	50	100
201451CD	AP4733	6	700	2.1mm x 5.5mm F 2	2.6 x 1.9 x 1.4	Black	6'	0.5	UL/CUL	\$4.95	\$3.95	\$2.95	\$2.19
147707CD	DC608F1	6	800	2.1mm x 5.5mm F 2	2.3 x 2.0 x 1.6	Black	6'	0.6	UL/CSA	4.95	4.49	4.05	3.65
220943CD	DCU060120	6	1200	2.1mm x 5.5mm F 1	2.5 x 2.0 x 1.7	Black	6'	0.7	UL/CUL	7.85	7.25	6.59	6.25
220951CD	DCU075100	7.5	1000	2.1mm x 5.5mm F 1	2.5 x 2.0 x 1.7	Black	6'	0.6	UL/CUL	9.19	8.59	7.55	7.19
196761CD	8233	7.5	1100	2.1mm x 5.5mm F 2	2.1 x 1.9 x 1.0	Black	6'	0.2	UL/CSA	6.49	5.85	5.29	4.75
127511CD	DC810F1	8	1000	2.1mm x 5.5mm F 2	3.1 x 2.5 x 2.1	Black	6'	1.3	UL	8.95	8.09	7.25	6.55
134025CD	DC902F11	9	200	2.1mm x 5.5mm F 1	2.1 x 1.7 x 1.6	Black	6'	0.4	UL/CSA	4.95	4.49	3.95	3.59
100845CD	DC902F12	9	200	2.1mm x 5.5mm F 2	2.1 x 1.7 x 1.5	Black	6'	0.4	UL/CSA	3.95	3.59	2.89	2.19
170958CD	HKA0920EC	9	200	2.1mm x 5.5mm F 2 (230VAC input; Europe)	2.6 x 1.7 x 1.6	Black	6'	0.5	TUV/CE	1.25	.99	.75	.59
100837CD	DIA3590	9	200	3.5mm M 2	2.6 x 1.8 x 1.6	Black	6'	0.4	UL/CSA	3.95	3.59	3.25	2.95
191767CD	CTPS350903002CD	9	300	1.3mm x 3.5mm right angle F 2	2.3 x 1.8 x 1.5	Black	6'	0.4	UL/CSA	3.69	3.39	2.69	1.99
133891CD	DC903F1	9	300	2.1mm x 5.5mm F 2	2.0 x 1.5 x 1.5	Black	6'	0.4	UL/CSA	3.95	3.59	2.85	2.15
189237CD	35-9-300C	9	300	2.5mm x 5.5mm F 2	2.2 x 1.7 x 1.4	Black	6'	0.4	UL/CSA	4.25	3.59	2.95	2.35
216469CD	D350900300U	9	300	2.5mm x 5.5mm F 1	2.4 x 1.7 x 1.7	Black	6'	0.4	UL/CUL	4.49	3.95	3.55	3.19
169519CD	KX-TCA1	9	350	2.1mm x 5.5mm right angle F 1	2.7 x 1.7 x 1.6	Dk. Gray	6'	0.4	UL/CSA	4.49	4.05	3.25	2.45
202155CD	DC9035F12	9	350	2.1mm x 5.5mm F 2	3.2 x 2.4 x 2.0	Black	6'	0.3	UL/CUL	2.95	2.65	2.39	2.15
202163CD	DC904F12	9	400	2.1mm x 5.5mm F 2	3.3 x 2.9 x 2.3	Black	6'	0.5	UL/CUL	3.05	2.75	2.55	2.29
140636CD	DC904F5	9	400	2.5mm x 5.5mm F 2	2.6 x 2.0 x 2.0	Black	6'	0.6	UL/CSA	3.69	3.35	2.99	2.69
202171CD	DC9045F12	9	450	2.1mm x 5.5mm F 2	3.3 x 2.9 x 2.3	Black	6'	0.5	UL/CUL	3.55	3.25	2.95	2.65
163627CD	DC905F11	9	500	2.1mm x 5.5mm F 1	2.5 x 1.9 x 1.7	Black	6'	0.6	UL/CSA	5.49	4.95	4.45	3.95
170270CD	PQLV1	9	500	2.1mm x 5.5mm right angle F 1	2.7 x 1.9 x 1.8	Gray	6'	0.6	UL/CSA	3.49	3.15	2.85	2.55
100853CD	DC905F12	9	500	2.1mm x 5.5mm F 2	2.5 x 1.9 x 1.7	Black	6'	0.6	UL/CSA	4.49	4.05	3.65	3.29
147731CD	43-1125	9	500	2.1mm x 5.5mm F 2	2.6 x 2.0 x 1.7	Beige	6'	0.6	UL/CSA	5.39	4.65	4.15	3.85
180540CD	FZ1729A	9	500	2.5mm x 5.5mm right angle F 2	2.4 x 1.2 x 1.6	Black	6'	0.4	UL/CSA	4.49	4.05	3.65	3.29
15561CD	DC905M3	9	500	3.5mm M 2	2.5 x 2.0 x 1.6	Black	6'	0.5	UL/CSA	4.69	3.76	3.28	3.15
202180CD	DC906F12	9	600	2.1mm x 5.5mm F 2	3.3 x 2.9 x 2.3	Black	6'	0.6	UL/CUL	4.49	4.05	3.65	3.29
100175CD	DC906F5	9	600	2.5mm x 5.5mm F 2	2.5 x 1.9 x 1.8	Black	6'	0.6	UL/CSA	5.49	4.75	4.25	3.95
202198CD	DC908F12	9	800	2.1mm x 5.5mm F 2	3.3 x 2.9 x 2.3	Black	6'	0.6	UL/CUL	6.95	6.29	5.25	3.69
164929CD	48-9-900D	9	900	2.1mm x 5.5mm F 1	2.7 x 2.3 x 1.8	Black	6'	0.9	UL/CUL	6.95	6.29	5.05	3.79
100888CD	48-09-1000D	9	1000	2.1mm x 5.5mm F 2	2.6 x 2.4 x 2.0	Black	6'	1.0	UL/CSA	7.95	7.19	5.75	4.35
127503CD	DC910F5	9	1000	2.5mm x 5.5mm F 2	2.6 x 2.4 x 2.0	Black	6'	0.9	UL/CSA	7.49	6.75	5.39	4.05
15587CD	PAG1200	9	1000	3.5mm M 2	2.6 x 2.4 x 2.0	Black	6'	0.9	UL/CSA	7.95	7.19	5.75	4.29
130526CD	DC912F11	9	1200	2.1mm x 5.5mm F 1	2.4 x 2.0 x 1.8	Black	6'	1.0	UL/CSA	8.95	8.09	7.29	6.59
143693CD	DC915F1	9	1500	2.1mm x 5.5mm F 2	3.3 x 2.5 x 2.3	Black	6'	1.3	UL/CSA	9.95	8.99	7.19	5.39
163993CD	DC1202F11R	12	200	2.1mm x 5.5mm right angle F 1	2.4 x 1.7 x 1.6	Black	6'	0.4	UL/CSA	4.25	3.89	3.09	2.34
100095CD	DC1202F1	12	200	2.1mm x 5.5mm F 2	2.1 x 1.8 x 1.5	Black	6'	0.4	UL/CSA	3.95	3.49	3.06	2.75
158043CD	DC1202F12R	12	200	2.1mm x 5.5mm right angle F 2	2.2 x 1.7 x 1.5	Black	6'	0.4	UL/CSA	3.95	3.55	3.19	2.89
220433CD	DBU120020	12	200	2.5mm x 5.5mm right angle F 2	2.2 x 1.7 x 1.5	Lt. Gray	6'	0.4	UL/CSA	3.89	3.49	3.15	2.85
185658CD	DV1220DCB	12	200	2.5mm x 5.5mm right angle F 2	2.2 x 1.7 x 1.5	Black	6'	0.4	UL/CSA	4.25	3.89	3.09	2.35
211238CD	35D-12-250	12	250	2.5mm right angle M 2	2.2 x 1.7 x 1.5	Black	6'	0.4	UL/CSA	3.95	3.55	3.19	2.89
219601CD	DCU120025	12	250	Stripped & tinned	2.5 x 2.0 x 1.7	Dk. Gray	6'	0.4	UL/CUL	3.95	3.55	3.25	2.85
163491CD	AD1230	12	300	Connector end may vary	2.2 x 2.2 x 1.6	Black	6'	0.5	UL/CSA	4.29	3.89	3.49	3.09
201099CD	SPN4230A	12	300	1.3mm x 3.5mm right angle F 2	2.3 x 2.0 x 1.7	Black	6'	0.5	UL/CSA	4.49	4.09	3.29	2.45
127976CD	DC1203F12	12	300	2.1mm x 5.5mm F 2	2.6 x 1.8 x 1.6	Black	6'	0.7	UL/CSA	4.75	4.25	3.79	3.49
190043CD	41-2-15	12	300	2.5mm x 5.5mm right angle F 2	2.9 x 2.0 x 1.6	Black	6'	0.5	UL/CSA	4.49	4.09	3.29	2.45

* Manufacturer may vary

AC-to-DC Wall Transformers continued on page 54 - 57

Jameco Special Values! See the yellow and green highlighted items. Sale details are on page 4.

AC-to-DC Unregulated Wall Transformers (Adapters) *continued*



We specialize in Wall Transformers – Call for additional OEM PRICING.



15392CD



213559CD



Female



Male



Stripped



101291CD



211051CD

We will change any power plug (pg 59) on any DC wall transformer listed (100 pc. minimum).

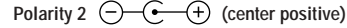
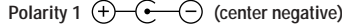

• Input: 120VAC @ 60Hz

SALE

2-Wire AC Input

Part Number	Mfr. Cross Reference No. *	Output Rating		Output Plug ID x OD Plug Type / Polarity F = female; M = male	Size (+0%-20%) H" x W" x D"	Case Color	Output Cord Length	Weight (lbs.)	Agency Approvals	Pricing			
		Voltage (VDC)	Current (mA)							1	10	50	100
190502CD	DV1140DC	12	400	2.1mm x 5.5mm right angle F 2	2.6 x 2.1 x 1.9	Black	6'	0.5	UL/CUL	\$5.95	\$5.39	\$4.85	\$4.35
114825CD	DC1205ST	12	500	Connector end may vary	2.5 x 2.0 x 1.7	Black	6'	0.6	CUL	4.75	4.35	3.45	2.59
15368CD	DC1205F11	12	500	2.1mm x 5.5mm F 1	2.5 x 1.9 x 1.6	Black	6'	0.6	UL/CSA	6.49	5.85	5.29	4.75
195741CD	DC1205F11RG	12	500	2.1mm x 5.5mm right angle F 1	2.5 x 2.0 x 1.7	Lt. Gray	6'	0.6	UL/CUL	5.95	5.39	4.69	4.19
102496CD	DC1205F12	12	500	2.1mm x 5.5mm F 2	2.5 x 1.9 x 1.6	Black	6'	0.6	UL/CSA	4.95	4.49	4.05	3.65
131300CD	SCP41	12	500	2.1mm x 5.5mm right angle F 2	2.6 x 1.9 x 1.7	Beige	6'	0.6	UL/CSA	4.95	4.49	4.05	3.65
200125CD	DV1250	12	500	2.5mm x 5.5mm F 1	2.4 x 2.0 x 1.6	Black	6'	1.0	UL/CSA	4.95	4.49	3.59	2.69
102277CD	DC1205F5	12	500	2.5mm x 5.5mm F 2	2.5 x 2.1 x 1.7	Black	6'	0.6	UL/CSA	4.95	4.49	4.05	3.65
17267CD	DC1205M3	12	500	3.5mm M 2	2.5 x 1.9 x 1.6	Black	6'	0.6	UL/CSA	4.95	4.49	4.05	3.65
202201CD	DC1206F12	12	600	2.1mm x 5.5mm F 2	3.3 x 2.9 x 2.3	Black	6'	0.6	UL/CUL	4.69	4.25	3.85	3.45
202219CD	DC120F12	12	700	2.1mm x 5.5mm F 2	3.3 x 2.9 x 2.3	Black	6'	0.6	UL/CUL	5.79	5.25	4.19	3.15
117479CD	DC1208F1	12	800	2.1mm x 5.5mm F 2	3.0 x 2.3 x 2.0	Black	6'	0.9	UL/CSA	6.49	5.85	5.29	4.75
181711CD	48D12800B	12	800	2.1mm x 5.5mm F 2 (240VAC input; UK Plug)	3.2 x 2.2 x 2.2	Black	6'	1.1	CE/TUV	3.95	3.55	3.19	2.89
129331CD	48-12-800	12	800	2.5mm x 5.5mm F 2	3.0 x 2.3 x 2.0	Black	6'	0.9	UL/CSA	5.49	4.95	4.45	4.05
211051CD	DV-1280 Dual	12	800	2.5mm x 5.5mm right angle F 2 w/ input switch	2.6 x 2.4 x 1.9	Black	6'	0.9	—	5.39	4.85	4.35	3.95
121232CD	DC1208M3	12	800	3.5mm M 2	2.6 x 2.4 x 2.0	Black	6'	0.9	UL/CSA	5.95	5.39	4.49	3.19
100870CD	DC1210F1	12	1000	2.1mm x 5.5mm F 2	3.1 x 2.4 x 2.0	Black	6'	0.9	UL/CSA	7.95	6.95	6.25	5.59
105478CD	DC1210F5	12	1000	2.5mm x 5.5mm F 2	3.1 x 2.4 x 2.0	Black	6'	1.0	UL/CSA	6.95	6.25	5.59	4.95
199566CD	WK1201A01DN	12	1000	2.5mm x 5.5mm F 2 (w/ RF filter)	3.2 x 2.2 x 2.0	Black	6'	1.2	UL/CSA	5.95	5.39	4.35	3.25
189579CD	BCU12100	12	1000	2.5mm x 5.5mm right angle F 2	3.2 x 2.2 x 1.9	Black	6'	1.0	UL/CSA	7.95	7.19	5.75	4.35
15392CD	DC1210M3	12	1000	3.5mm M 2	3.3 x 2.4 x 2.0	Black	6'	1.0	UL/CSA	7.19	6.49	5.85	5.25
213559CD	GPC-081	12	1000	Auto lighter power outlet	4.3 x 2.2 x 1.9	Black	—	1.1	UL/CUL	14.95	13.49	12.19	10.95
196779CD	D1212950	12	1200	2.5mm x 5.5mm F 2	3.0 x 2.3 x 1.9	Black	6'	1.0	UL/CUL	7.79	6.95	6.29	5.69
220687CD	L15D12B-PIJ	12	1250	2.1mm x 5.5mm F 2	3.1 x 2.2 x 1.2	Black	6'	0.4	UL/CSA/TUV	11.95	10.79	9.75	8.75
189325CD	57D12-1500	12	1500	Cut, stripped and tinned (w/ on-off switch)	3.4 x 2.6 x 2.2	Black	8'	1.5	UL	9.95	8.99	7.19	5.39
203035CD	A41215	12	1500	2.1mm x 5.5mm F 1	3.6 x 2.5 x 1.9	Black	6'	1.5	UL/CSA	11.95	10.79	8.65	6.49
136881CD	DC1215F1	12	1500	2.1mm x 5.5mm F 2	3.4 x 2.7 x 2.2	Black	6'	1.5	UL	12.95	11.69	10.55	9.45
101291CD	DC1215F5	12	1500	2.5mm x 5.5mm F 2	3.4 x 2.7 x 2.2	Black	6'	1.5	UL	9.95	8.99	8.09	7.25
192786CD	MK135100	13.5	1000	2.1mm x 5.5mm F 2	2.9 x 2.3 x 2.0	Black	6'	1.0	UL	8.95	8.09	6.45	4.85
210817CD	MK135100-1	13.5	1000	2.1mm x 5.5mm F 2	2.9 x 2.3 x 1.9	Black	6'	1.0	UL	9.95	8.99	7.19	5.39
212812CD	DC1402F12	14	200	2.1mm x 5.5mm F 2	2.2 x 1.7 x 1.5	Black	6'	0.8	UL/CUL	3.95	3.59	3.25	2.89
212821CD	DC1403F12	14	300	2.1mm x 5.5mm F 2	2.2 x 1.7 x 1.5	Black	6'	0.8	UL/CUL	4.95	4.49	3.95	3.59
129314CD	DV-1250	14	360	2.5mm x 5.5mm right angle F 2	2.3 x 2.0 x 1.6	Black	6'	0.6	UL/CSA	4.95	4.49	3.59	2.69
212839CD	DC1405F12	14	500	2.1mm x 5.5mm F 2	2.2 x 1.7 x 1.5	Black	6'	0.8	UL/CUL	5.95	5.35	4.79	4.29
123932CD	DC1407F1	14	700	2.1mm x 5.5mm F 2	2.6 x 2.4 x 2.0	Black	6'	1.0	UL/CSA	8.49	7.65	6.89	6.19
202243CD	DC1407F52	14	700	2.5mm x 5.5mm F 2	3.9 x 2.9 x 2.4	Black	6'	0.8	UL/CUL	5.19	4.69	4.19	3.79
202251CD	DC1408F12	14	850	2.1mm x 5.5mm F 2	3.9 x 2.9 x 2.4	Black	6'	0.8	UL/CUL	5.39	4.85	4.35	3.95
202260CD	DC1410F12	14	1000	2.1mm x 5.5mm F 2	3.9 x 2.9 x 2.4	Black	6'	0.9	UL/CUL	7.95	6.95	6.25	5.59
190001CD	DC1505F1	15	500	2.1mm x 5.5mm F 2	2.3 x 2.4 x 1.9	Black	6'	0.8	UL/CSA	6.95	6.29	5.65	5.09
189982CD	DC1505F5	15	500	2.5mm x 5.5mm F 2	2.3 x 2.4 x 1.9	Black	6'	0.8	UL/CSA	6.95	6.29	5.05	3.79
220927CD	DCU150080	15	600	2.1mm x 5.5mm F 1	2.9 x 2.3 x 1.9	Black	6'	0.8	UL/CUL	9.15	8.55	7.49	7.15
155803CD	DC1506F11	15	600	2.1mm x 5.5mm F 1	2.9 x 2.3 x 1.9	Black	6'	1.0	UL/CSA	7.95	7.19	6.45	5.85
203502CD	48150900	15	900	2.5mm x 5.5mm F 2	2.6 x 2.2 x 1.9	Black	6'	1.0	UL/CSA	6.95	6.25	5.49	4.75
151992CD	AD-SS-2	15	1000	2.1mm x 5.5mm F 1	3.1 x 2.0 x 1.9	Beige	6'	1.5	UL/CSA	9.69	8.69	7.85	6.19
191652CD	DC1510F12	15	1000	2.1mm x 5.5mm F 2	3.3 x 2.2 x 1.9	Black	6'	1.0	UL/CSA	9.59	8.65	7.79	6.99

* Manufacturer may vary

AC-to-DC Wall Transformers continued on page 54 - 57

Order Anytime 24x7x365

Phone 1-800-831-4242

Fax 1-800-237-6948

Online www.Jameco.com

AC-to-DC Unregulated Wall Transformers (Adapters) *continued*

We specialize in Wall Transformers – Call for additional OEM PRICING.



217541CD



163643CD



Female



Male



Stripped



117321CD



123158CD



We will change any power plug (pg 59) on any DC wall transformer listed (100 pc. minimum).

Polarity 1 ⊕ ⊖ (center negative)

Polarity 2 ⊖ ⊕ (center positive)

• Input: 120VAC @ 60Hz

2-Wire AC Input

Part Number	Mfr. Cross Reference No. *	Output Rating		Output Plug ID x OD Plug Type / Polarity F = female; M = male	Size (+0%-20%) H" x W" x D"	Case Color	Output Cord Length	Weight (lbs.)	Agency Approvals	Pricing			
		Voltage (VDC)	Current (mA)							1	10	50	100
162317CD	DC1605F1	16	500	2.1mm x 5.5mm F 2	2.2 x 2.4 x 1.9	Black	6'	0.8	UL/CSA	\$7.95	\$6.95	\$6.25	\$5.59
217541CD	FE4116168C030	16.8	300	2.5mm x 5.5mm F 2 w/ LED indicator	3.1 x 2.1 x 1.6	Black	6'	0.6	UL/CUL	5.95	5.35	4.85	4.35
181729CD	CXV18250	18	250	2.1mm x 5.5mm F 2	2.6 x 2.0 x 1.6	Black	6'	0.6	UL	5.95	5.39	4.85	4.39
217568CD	FE4126180P040	18	400	2.5mm x 2.5mm F 2 w/ LED indicator	3.5 x 2.1 x 1.6	Black	6'	0.8	UL/CUL	6.95	6.25	5.65	5.09
163272CD	48-18-500D	18	500	2.1mm x 5.5mm F 2	2.6 x 2.3 x 1.9	Black	6'	0.8	UL/CUL	9.95	8.99	8.09	7.25
206957CD	WD1H1000LCX	18	1000	2.5mm x 5.5mm F 2	3.4 x 2.6 x 2.1	Black	6'	1.4	---	9.95	8.99	7.19	5.39
203158CD	RJK-24251-N	24	250	2.1mm x 5.5mm F 2	3.2 x 2.2 x 1.9	Black	6'	1.3	---	6.95	6.25	5.59	4.95
102285CD	DC2404F1	24	400	2.1mm x 5.5mm F 2	3.0 x 2.3 x 2.0	Black	6'	0.9	UL/CUL	7.95	7.19	6.45	5.85
163635CD	DC2405F11	24	500	2.1mm x 5.5mm F 1	3.1 x 2.3 x 1.9	Black	6'	1.0	UL/CUL	8.95	8.09	7.25	6.55
191556CD	DC2405F5	24	500	2.5mm x 5.5mm F 2	3.1 x 2.3 x 1.9	Black	6'	1.0	UL/CUL	8.95	8.09	7.29	6.55
139088CD	DC2405M3	24	500	3.5mm M 2	3.1 x 2.3 x 1.9	Black	6'	1.0	UL/CUL	7.95	7.19	5.75	4.29
196322CD	P48240600A020G	24	600	2.1mm x 5.5mm F 2	3.3 x 2.3 x 1.9	Black	6'	1.1	UL/CSA	8.95	8.09	7.29	6.55
168495CD	DC2408F1	24	800	2.1mm x 5.5mm F 2	2.9 x 1.9 x 1.6	Black	6'	0.4	UL/CUL/TUV	9.95	8.99	7.19	5.39
220960CD	DFU240100	24	1000	2.1mm x 5.5mm F 1	3.4 x 2.7 x 2.2	Black	6'	1.6	UL/CUL	13.89	12.95	11.39	10.89
163651CD	DC2412F11	24	1200	2.1mm x 5.5mm F 1	3.8 x 3.0 x 2.6	Black	6'	2.0	---	14.95	13.49	10.79	8.09
163643CD	DC2412F12	24	1200	2.1mm x 5.5mm F 2	3.8 x 3.0 x 2.6	Black	6'	2.0	---	14.95	13.49	12.15	10.95
117321CD	DC2412F5	24	1200	2.5mm x 5.5mm F 2	3.8 x 3.0 x 2.6	Black	6'	2.0	---	14.95	13.49	12.15	10.95
121241CD	DC2412M3	24	1200	3.5mm M 2	3.4 x 2.7 x 2.2	Black	6'	2.0	---	12.95	11.49	9.95	8.95
199523CD	DDU300050	30	500	2.5mm x 5.5mm F 2	2.9 x 2.3 x 1.9	Black	6'	1.1	UL/CUL	9.95	8.95	7.95	6.95
215095CD	MW48-4800250	48	250	2.5mm x 5.5mm F 2	2.9 x 2.3 x 1.9	Black	6'	1.1	UL/CUL	7.95	7.15	6.49	5.79
215108CD	MW48-4800500	48	500	2.5mm x 5.5mm F 2	2.9 x 2.3 x 1.9	Black	6'	1.1	UL/CUL	10.95	9.85	8.85	7.95
15309CD	DCM05	3, 4.5, 6, 7.5, 9, 12	500	1.35 x 3.5, 2.1 x 5.0, 2.5 x 5.5 female 2.5, 3.5 male, 9V battery snap (LED ind.)	3.0 x 2.2 x 2.1	Black	6'	0.7	UL/CSA	8.95	7.95	6.95	6.25
190641CD	DCM08	3, 4.5, 6, 7.5, 9, 12	800	1.5 x 5.5, 2.1 x 5.0, 2.1 x 5.5, 2.5 x 5.5 fem 2.5, 3.5 male, polarity sw. (LED ind.)	3.9 x 2.7 x 2.3	Black	6'	0.9	UL/CSA	7.95	7.19	5.75	4.29
123158CD	DCM10 †	1.5, 3, 4.5, 6, 7.5, 9, 12	1000	1.35 x 3.5, 2.1 x 5.0, 2.5 x 5.5 female 2.5, 3.5 male, 9V battery snap (LED ind.)	3.7 x 2.2 x 2.5	Black	6'	0.9	---	9.95	8.95	7.95	6.95

* Manufacturer may vary † 120 to 220VAC

AC-to-DC Wall Transformers continued on pages 54 - 56

Table-Top AC-to-AC Transformers



176604CD

AC-to-AC Table-Top Step-Down Transformers

• Input voltage: 120VAC @ 60Hz • Attached AC cord

SALE



Part Number	Mfr. Cross Ref. No. *	Output			Output Plug ID x OD Plug Type	Color	Size (+0%-20%) (L" x W" x H")	Cord (AC/AC)	Wt. (lbs.)	Agency Approvals	Pricing			
		Volts (VAC)	Current (A)	Watts (W)							1	10	50	100
176604CD	TA661640	16	4.0	64	2.1mm x 5.5mm female	Black	3.7 x 2.9 x 2.5	6' / 6'	2.8	CSA	\$12.95	\$11.49	\$9.95	\$8.95
147310CD	0931RB	24	0.70	17	3-pin (0.156") female housing	Black	3.2 x 2.2 x 1.9	6' / 6'	1.1	UL	1.35	1.25	1.15	1.05
152135CD	100380-001	24	1.46	35	2.1mm x 5.5mm female	Black	3.6 x 2.7 x 2.1	3'5" / 5'6"	1.9	UL/CSA	3.15	2.85	2.59	2.35

* Manufacturer may vary

AC-to-AC Wall Transformers continued on page 58

30-Day Money-Back Guarantee

If you're not completely satisfied, we'll take it back! Details on page 217.

AC-to-AC Wall Transformers (Adapters)



We specialize in Wall Transformers – Call for additional OEM PRICING.



We will change any power plug (pg 59) on any wall transformer listed (100 pc. minimum).

• Input: 120VAC @ 60Hz



SALE

2-Wire AC Input

Part Number	Mfr. Cross Reference No. *	Output Rating		Output Plug		Size (+0%-20%) H" x W" x D"	Case Color	Output Cord Length	Weight (lbs.)	Agency Approvals	Pricing				
		Voltage (VDC)	Current (mA)	ID x OD Plug Type F = female; M = male							1	10	50	100	
101127CD	DFX10096B	7	1500	2.5mm x 5.5mm F		1.9 x 2.2 x 2.0	Black	7' 6"	0.8	UL/CSA	\$4.95	\$4.49	\$3.95	\$3.49	
219660CD	SLA40810	8	1000	2.1mm x 5.5mm F		2.2 x 2.1 x 1.6	Black	6'	0.7	UL/CSA	4.95	4.45	3.95	3.59	
211078CD	DV-8135A	8.5	1350	2.5mm x 5.5mm F		2.2 x 2.0 x 1.7	Black	6'	0.9	UL/CSA	4.95	4.49	3.95	3.65	
219619CD	ABU09005	9	50	2.1mm x 5.5mm F		2.2 x 1.8 x 1.5	Black	6'	0.3	UL/CSA	3.29	2.95	2.65	2.39	
210729CD	MKA35090300	9	300	2.1mm x 5.5mm F		2.2 x 1.7 x 1.5	Black	6'	0.4	UL/CUL	3.95	3.55	2.95	2.49	
184751CD	M/N40	9	450	2.1mm x 5.5mm right angle F		2.8 x 2.0 x 1.7	Black	6'	0.8	UL/CSA	4.95	4.49	3.59	2.69	
100061CD	AC905F1	9	500	2.1mm x 5.5mm F		2.4 x 2.0 x 1.6	Black	6'	0.6	UL/CUL	4.59	3.95	3.45	3.25	
226131CD	AA0950	9	500	2.5mm x 5.5mm F		2.5 x 2.1 x 1.7	Black	6'	0.5	UL/CSA	4.49	3.99	3.65	3.29	
119204CD	A41090800	9	800	2.1mm x 5.5mm F		2.6 x 1.9 x 1.7	Black	6'	0.6	UL	4.49	3.59	2.69	1.89	
120141CD	AC908M3	9	800	3.5mm M		2.6 x 1.9 x 1.7	Black	6'	0.5	UL	4.95	4.49	4.05	3.65	
102234CD	AC910F1	9	1000	2.1mm x 5.5mm F		3.2 x 2.2 x 1.9	Black	6'	0.6	UL/CSA	4.49	4.05	3.65	3.29	
157041CD	41A9-1000	9	1000	2.5mm x 5.5mm F		2.1 x 2.1 x 1.6	Black	6'	0.6	UL/CSA	6.95	6.29	5.65	5.09	
112336CD	AC915F5	9	1500	2.5mm x 5.5mm F		2.5 x 2.2 x 2.0	Black	6'	0.9	UL	9.95	8.99	8.09	7.29	
217550CD	FW6798	9	1900	Stripped and tinned		2.8 x 2.5 x 2.0	Black	6'8"	1.1	UL/CSA	8.95	8.09	7.25	6.55	
210745CD	A4110050T	10	500	2.1mm x 5.5mm F		3.0 x 2.1 x 1.7	Black	6'	0.6	UL/CSA	4.49	4.05	3.65	3.29	
101258CD	41A12-500	12	500	2.1mm x 5.5mm F		2.8 x 2.0 x 1.6	Black	6'	0.6	UL/CSA	4.59	4.15	3.65	3.29	
211271CD	AA-1250	12	500	2.5mm x 5.5mm F		2.3 x 2.1 x 1.6	Black	6'	0.6	UL/CSA	4.59	4.15	3.65	3.29	
189202CD	A41A12-830	12	830	2.1mm x 5.5mm F		2.0 x 2.1 x 1.6	Black	6'	0.7	UL/CSA	5.29	4.79	3.85	2.89	
10081CD	AC1210F1	12	1000	2.1mm x 5.5mm F		2.6 x 2.4 x 2.0	Black	6'	0.7	UL/CSA	4.95	4.49	3.99	3.59	
100167CD	AC1210F5	12	1000	2.5mm x 5.5mm F		3.2 x 2.4 x 2.0	Black	6'	0.7	UL/CSA	4.95	4.49	4.05	3.65	
10428CD	AC1210M3	12	1000	3.5mm M		2.6 x 2.4 x 2.0	Black	6'	0.6	UL/CUL	4.95	4.49	4.05	3.65	
167151CD	HET57116	12	1500	2.1mm x 5.5mm F		3.4 x 2.7 x 2.2	Black	6'	1.5	—	4.95	4.49	3.59	2.69	
206607CD	T48-121667-A030C	12	1600	2.5mm x 5.5mm F		2.5 x 2.2 x 2.0	Black	6'	0.9	UL/CUL	9.95	8.99	7.19	5.39	
153761CD	AC1216M3	12	1600	3.5mm male		2.5 x 2.2 x 1.9	Black	6'	0.9	UL	10.95	9.89	8.89	7.99	
206404CD	MGT1220	12	1670	Screw terminals		3.2 x 2.2 x 1.9	White	—	0.9	UL/CSA	8.95	8.09	7.25	6.55	
210737CD	PPI-1212UL	13	1200	2.1mm x 5.5mm F		3.3 x 2.4 x 2.0	Black	6'	0.9	UL/CUL	4.95	4.49	3.59	2.69	
171408CD	AC1405F1	14	500	2.1mm x 5.5mm F		2.8 x 2.0 x 1.6	Black	6'	0.6	UL/CSA	4.95	4.49	3.95	3.49	
171854CD	DV1485AC	14	850	2.5mm x 5.5mm right angle F		3.0 x 2.0 x 1.7	Black	6'	0.7	UL/CUL	6.95	6.29	5.04	3.79	
201101CD	SPN4340A	15	200	1.3mm x 3.5mm F		2.2 x 1.8 x 1.5	Black	6'	0.5	UL/CSA	1.69	1.55	1.39	1.29	
100108CD	AC1610F1	16	1000	2.1mm x 5.5mm F		2.5 x 2.2 x 1.9	Black	6'	0.9	UL/CSA	7.95	7.19	6.45	5.85	
163053CD	035-0165	16	1100	2.5mm x 5.5mm F		3.2 x 2.3 x 1.8	Black	6'	1.1	UL/CSA	8.95	8.09	6.49	4.85	
206412CD	MGT1620	16.5	1250	Screw terminals		3.2 x 2.2 x 1.9	White	—	0.9	UL/CSA	7.95	7.19	6.45	5.85	
121216CD	AC1810F1	18	1000	2.1mm x 5.5mm F		3.1 x 2.7 x 1.9	Black	6'	1.1	UL/CUL	8.95	8.09	6.49	4.89	
185439CD	T5182200-A020G	18	1850	2.1mm x 5.5mm right angle F		3.3 x 2.7 x 2.2	Black	6'	1.7	UL/CSA	7.95	7.19	6.49	5.85	
206421CD	MGT2410	24	420	Screw terminals		2.5 x 2.0 x 1.7	White	—	0.6	UL/CSA	8.49	7.65	6.89	6.19	
87581CD	AC2405F1	24	500	2.1mm x 5.5mm F		2.5 x 2.2 x 1.9	Black	6'	0.9	UL/CSA	56.95	4.95	4.49	3.99	3.65
206439CD	MGT2420	24	830	Screw terminals		3.2 x 2.2 x 1.9	White	—	0.9	UL/CSA	8.95	8.09	7.25	6.55	
140599CD	AC2410F1	24	1000	2.1mm x 5.5mm F		3.0 x 2.2 x 1.9	Black	6'	1.2	UL/CSA	8.95	8.09	6.49	4.89	
10102CD	AC2410M3	24	1000	3.5mm male		3.0 x 2.2 x 1.9	Black	6'	1.2	UL/CSA	7.95	7.19	6.45	5.85	
176356CD	WP573024	24	1250	2.1mm x 5.5mm F		3.4 x 2.7 x 2.2	Black	5'8"	1.6	UL/CSA	10.49	9.45	8.55	7.65	

* Manufacturer may vary

AC-to-DC Wall Transformers continued on pages 54-57

Wall Transformer Enclosures

- Enclosures include 3-prong power plug & cable strain relief
- Size: 3.4"H x 2.7"W x 2.3"D
- Material: noryl
- Color: black

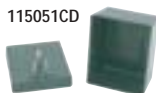

Part No.	Style	1	10	100
115051CD	Non-vented	\$2.25	\$1.95	\$1.69
115043CD	Vented	2.25	1.95	1.69



Don't worry about backorders.
Over 99% of our products are in stock!

We'll Send It Today!

Just place your order by 6PM EST
for same business day shipment

Male & Female Power Jacks

- Use with mating power plugs, below
- Dimensions do not include barrel

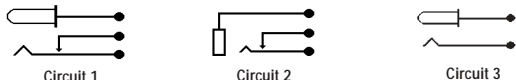

Mounting	Code
Panel	C
PCB	D
Panel & PCB	E
Cable	F

Terminals	Code
Solder eyelet	A
PC board	B

SALE

* Prepackaged: order in increments of 10, 100 or 1000

Part Number	Mfr. Cross Ref. No.	Dimensions H x W x D (mm)	Type/ Mount	Circuit/ Terminal	Mating Plug (below)	Pricing			
						1	10	100	1000
1.3 mm Male Jacks									
101194CD	PP024	6.0 x 6.0 x 9.0	9/D	1/B	1.3 mm female	\$.89	\$.80	\$.75	\$.65
2.1 mm Male Jacks									
101178CD	PP014	10.9 x 9.0 x 14.5	1/D	1/A	2.1 mm female	\$.59 .49	.44	.39	.35
137672CD	PP013	10.9 x 9.0 x 14.5	6/D	3/A	2.1 mm female	.49	.44	.40	.36
151589CD	DPJ-02IA	13.0 x 12.6 Dia.	8/C	1/A	2.1 mm female	1.09	.93	.70	.65
151554CD	DPJ-026	15.1 x 8.0 Dia.	7/E	1/A	2.1 mm female	1.49	1.25	1.05	.89
159610CD	PJ1014A	35.8 x 12.6 Dia.	11/F	3/A	2.1 mm female	1.49	1.25	1.09	.89
2.5 mm Male Jacks									
109428CD	PJ025PCB	8.0 x 12.0 x 9.6	5/D	1/B	2.5 mm female	.36	.32	.29	.26
207714CD	HEC0470	11.0 x 9.0 x 14.5	1/D	1/B	2.5 mm female	.45	.35	.29	.25
101186CD	PP014A	11.0 x 9.0 x 14.5	1/D	1/A	2.5 mm female	.65	.59	.55	.49
102091CD	PP15A	20.4 x 9.3 x 11.7	2/C	1/A	2.5 mm female	*	.07	.05	.04
151562CD	DPJ-026A	15.1 x 8.0 Dia.	7/E	1/A	2.5 mm female	1.49	1.24	1.13	.99
159505CD	PJ1015A	35.8 x 12.6 Dia.	11/F	3/A	2.5 mm female	1.49	1.35	1.19	.99
202358CD	HD2388	17.0 x 12.0 Dia.	8/C	3/A	2.5 mm female	.99	.85	.75	.59
3.5 mm Female Jacks									
101143CD	PJ0352	10.0 x 10.0 x 18.5	3/E	2/A	3.5 mm male	.22	.20	.18	.16
109495CD	PJ035PM	10.5 x 9.0 x 8.8	4/C	2/A	3.5 mm male	.45	.40	.36	.32
165729CD	PJ0354	8.9 x 5.7 Dia.	10/C	3/A	3.5 mm male	.69	.59	.49	.39

Male & Female Power Plugs

- Use with mating power jacks found in table, above
- Solder eyelets 1mm diameter
- Threaded screw-on housing (strain relief)
- Use with AC/DC wall transformers, pgs 54-58
- Shield crimp tabs
- Use 24 AWG 2 conductor wire, P/N 100280CD, to make custom length power cables, pg 121



Part Number	Mfr. Cross Ref. No.	Description Plug ID x OD (mm)	Dimensions (mm) S (shaft) x L x ID (strain relief)	Type	Pricing			
					1	10	100	1000
Female Plug								
71191CD	PP137	1.3 x 3.5	9.6 x 43.9 x 4.8 (black)	1/A	\$.69	\$.59	\$.49	\$.39
191484CD	PP049W	2.1 x 5.5	9.6 x 43.9 x 4.5 (white)	1/A	.79	.69	.59	.45
28759CD	PP049	2.1 x 5.5 (P205)	8.5 x 41.4 x 4.6 (black)	1/A	.59	.49	.39	.29
147328CD	PP049L	2.1 x 5.5 (P205L)	14.0 x 46.4 x 4.6 (black)	1/A	.69	.59	.49	.39
138587CD	PJ021R	2.1 x 5.5 rt. angle	12.0 x 22.5 x 3.9 (black)	1/B	.79	.63	.55	.49
190537CD	PP109S	2.5 x 5.5 (P206S)	9.0 x 43.5 x 4.8 (black)	1/A	.39	.32	.29	.19
28767CD	PP109	2.5 x 5.5 (P206)	10.1 x 45.4 x 4.3 (black)	1/A	.59	.49	.39	.33
191492CD	PP109W	2.5 x 5.5	10.1 x 45.4 x 4.5 (white)	1/A	.69	.62	.50	.37
147336CD	PP109L	2.5 x 5.5 (P206L)	13.6 x 47.5 x 4.8 (black)	1/A	.69	.59	.53	.45
168241CD	PP109N	2.5 x 5.5	13.7 x 36.5 x 3.9 (black)	1/C	.59	.49	.43	.35
Male Plug								
101135CD	PJ1025	2.5 (P201)	11.1 x 49.0 x 4.3 (black)	2/A	.69	.55	.41	.29
147459CD	PJ1025L	2.5 (P201L)	10.5 x 48.0 x 5.0 (black)	2/A	.45	.41	.36	.33
101151CD	PJ1035	3.5 (P202)	13.8 x 51.8 x 4.2 (black)	2/A	.55	.50	.44	.36
147344CD	PJ1035L	3.5 (P202L)	14.1 x 51.0 x 5.2 (black)	2/A	.59	.53	.48	.43

DC-AC Inverters **SALE**

Cobra

- Input voltage: 12VDC
- Output voltage: 115VAC ±5%
- Input connector: automobile power plug
- Overload and thermal protection
- Weight: 2.0 lbs.

202809CD: Size: 4.1"L x 1.5"W x 1.5"H
• Output conn.: 2-prong receptacle

202817CD: Size: 5.1"L x 2.5"W x 1.5"H
• Output conn.: 3-prong receptacle

Part No.	Prod. No.	Watts	1	10	25
202809CD	P2	80 \$29.79	\$27.09	\$24.65
202817CD	P4	140	\$44.95 39.95	35.95	32.35

140 & 270-Watt DC-AC Inverters

188293CD

- Input voltage: 10-15VDC
- Output voltage: 110VAC @ 60Hz
- Battery low shutdown
- Peak power surge capable
- Battery low shutdown
- Overload & thermal protection
- Wt.: 1.3 lbs.

188293CD: Size: 5.5"L x 2.6"W x 1.6"H

202016CD: Size: 9.3"L x 4.1"W x 2.2"H

Part No.	Description	1	10	25
188293CD	140W auto plug	\$49.95	\$42.49	\$31.89
202016CD	270W auto/battery clip	64.95	58.49	52.65

Automobile Power Plug & Cord Assembly **SALE**

- Screw assembly with strain relief
- Plugs directly into cigarette lighter
- Accepts .25" x 1.25" fuse

124759CD: 3' cord pigtail end 115001CD 124759CD

Part No.	Description	1	10	100
115001CD	W/ 5A/250VAC fuse	\$1.95	\$1.65	\$1.19
124759CD	W/ 3A/250VAC fuse	1.89	1.72	1.69

Automobile Power Plug Splitter

- Input: cigarette adapter; non-fused
- Splits out into two 5" female automobile type receptacles

Part No.	Description	1	10	50
123182CD	Power plug splitter	\$4.95	\$4.49	\$3.95

DC-to-DC Power Converter

A high quality 1000mA regulated DC adapter with the ability to convert power from your cigarette lighter plug in 1.5V increments from 1.5V to 9.0V. You may choose from a full range of universal plugs (2.1mm/2.5mm jack/1/8" jack/9V battery snaps) and output polarity (center + or -). Perfect for cassette players, CD players, radios, mini TV's and many other battery run appliances.

- Two DC output cigarette lighter outlets
- Built-in 10A mini blade fuse on plug
- Size: 4.9"W x 2.8"D x 1.8"H

Part No.	Description	1	10
218819CD	DC-to-DC Converter	\$14.49	\$12.99
218801CD	10' Extension cord	6.49	5.99

DC Brushless Fans



163475CD



102921CD

Call for additional OEM PRICING – we carry major manufacturers.

- Low profile
- Ball and sleeve bearings
- Power input by lead wires or terminals
- PBT black thermo plastic frame and impeller
- Agency approved
- Low power consumption
- Low acoustical noise rating



102939CD



104205CD

Fans

Part Number	Manufacturer	Product Number	Voltage (VDC)	Size (W" x H" x D")	Air Flow (CFM)	Bearing	Current (mA)	Power (Watts)	Agency Approvals	Noise (dBA)	Connection (Leads)	Pricing			
												1	10	50	100
163475CD	Nidec	C34427-55APP	5	1.00 x 1.00 x 0.40	0.5	Ball	90	0.45	---	22	2"	\$5.95	\$5.39	\$4.35	\$3.25
131246CD	Adda	AD0205LX-G50	5	1.00 x 1.00 x 0.40	1.8	Sleeve	100	0.5	UL/CSA/CE	15.6	5.5"	8.49	7.65	6.89	6.59
206156CD	Sunon	KDE0502PFB3-8	5	1.00 x 1.00 x 0.40	1.83	Ball	60	0.3	UL/CSA/TUV/CE	23	5"	11.95	10.95	9.95	8.95
196373CD	Sunon	KD0504PFB2-8	5	1.60 x 1.60 x 0.40	5.5	Ball	120	0.4	UL/CUL	23	12"	8.49	7.65	6.89	6.19
102921CD	Sunon	KD0504PFS2-8	5	1.60 x 1.60 x 0.40	6.3	Sleeve	120	0.6	UL/CUL	24.3	12"	7.95	6.95	6.25	5.59
171678CD	Delta	AFB0405HHD	5	1.60 x 1.60 x 0.80	8.6	Ball	700	2.0	---	36	2.5"	5.95	5.39	4.35	3.25
207061CD	Adda	AD0505MB-G90	5	2.00 x 2.00 x 0.40	10.5	Ball	120	0.7	UL/CSA/CE	24	11"	7.95	6.95	6.25	5.59
204433CD	Toyo	USTF802505HW	5	3.15 x 3.15 x 1.00	36	Ball	650	2.0	UL/VDE/CE	29	12"	8.95	8.09	7.25	6.55
212804CD	Sunon	KDE1202PFB3-8	12	1.00 x 1.00 x 0.40	1.3	Ball	40	0.5	UL/CUL/TUV/CE/VDE	26	5.9"	10.95	9.89	8.89	7.99
102912CD	Sunon	KD1202PFB2-8	12	1.00 x 1.00 x 0.40	2.0	Ball	60	0.7	UL/CSA/TUV	30	6"	11.95	8.59	7.95	7.49
212791CD	Sunon	KDE1202PFB1-8	12	1.00 x 1.00 x 0.40	2.4	Ball	80	1.0	UL/CUL/TUV/CE/VDE	33	5.9"	11.95	8.59	7.95	7.49
212767CD	Sunon	KDE1203PFB3-8	12	1.20 x 1.20 x 0.40	2.3	Ball	50	0.6	UL/CUL/TUV/CE/VDE	18.5	5.9"	11.95	8.59	7.98	7.49
203166CD	Adda	AD0312LX-G50	12	1.20 x 1.20 x 0.40	3.0	Sleeve	70	0.84	UL/CUL/TUV/CE	20	5.5"	6.15	5.59	5.09	4.65
212775CD	Sunon	KDE1203PFB2-8	12	1.20 x 1.20 x 0.40	3.0	Ball	60	0.8	UL/CUL/TUV/CE/VDE	25	5.9"	10.95	9.89	8.89	7.99
212783CD	Sunon	KDE1203PFB1-8	12	1.20 x 1.20 x 0.40	3.5	Ball	75	0.9	UL/CUL/TUV/CE/VDE	27	5.9"	11.95	8.59	7.95	7.49
212732CD	Sunon	KDE1235PFB3-8	12	1.40 x 1.40 x 0.40	3.2	Ball	50	0.6	UL/CUL/TUV/CE/VDE	18	5.9"	11.95	10.79	9.69	8.75
212741CD	Sunon	KDE1235PFB2-8	12	1.40 x 1.40 x 0.40	4.5	Ball	60	0.8	UL/CUL/TUV/CE/VDE	21	5.9"	12.95	9.95	9.49	8.95
212759CD	Sunon	KDE1235PFB1-8	12	1.40 x 1.40 x 0.40	5.2	Ball	80	1.0	UL/CUL/TUV/CE/VDE	25	5.9"	12.95	9.95	9.49	8.95
207052CD	Adda	AD0412MB-K90	12	1.60 x 1.60 x 0.25	5.5	Ball	60	0.72	UL/CSA/TUV/CE	25	5"	6.95	6.25	5.59	4.95
191476CD	Common Wealth	FP-108HX/DC	12	1.60 x 1.60 x 0.40	4.0	Sleeve	60	0.72	UL/CSA/TUV/CE	25	12"	5.95	4.79	3.59	2.55
210796CD	Sunon	KD1204PFB3H	12	1.60 x 1.60 x 0.40	4.7	Ball	50	0.6	UL/CUL/TUV/CE	24	14"	6.95	6.25	5.59	4.95
102939CD	Jamicon	JF0410S1H	12	1.60 x 1.60 x 0.40	6.3	Sleeve	110	1.3	UL/CSA/TUV/CE	34.7	10.5"	6.95	6.29	5.65	4.95
189691CD	Sunon	KD1204PFS2	12	1.60 x 1.60 x 0.40	6.3	Sleeve	70	0.9	UL/CSA/TUV	24	12"	7.95	7.19	5.75	4.35
161699CD	Sunon	KD1204PFB2-8	12	1.60 x 1.60 x 0.40	6.3	Ball	70	0.6	UL/CSA/TUV	30	12"	7.95	6.95	6.25	5.59
212716CD	Sunon	KDE1204PFB2-H	12	1.60 x 1.60 x 0.40	6.5	Ball	90	1.1	UL/CUL/TUV/CE/VDE	27	12"	6.95	4.95	4.49	4.29
213428CD	Adda ¹	AD0412HB-G76	12	1.60 x 1.60 x 0.40	6.7	Ball	100	1.2	CE	30.2	12"/3 leads	7.95	6.95	6.25	5.59
212724CD	Sunon	KDE1204PFB1-H	12	1.60 x 1.60 x 0.40	8.3	Ball	110	1.4	UL/CUL/TUV/CE/VDE	34.4	12"	6.95	4.95	4.49	4.29
174131CD	Jamicon	JF0413S1M	12	1.60 x 1.60 x 0.50	3.8	Sleeve	90	1.1	UL/CSA/TUV	29	14"	3.49	3.15	2.85	2.55
213891CD	Adda	AD0412MB-D50	12	1.60 x 1.60 x 0.60	8.1	Ball	100	1.2	UL/CUL/CE	31.8	11.5"	7.95	7.19	6.45	5.85
136178CD	Adda	AD0412MS-C70	12	1.60 x 1.60 x 0.80	5	Sleeve	110	1.32	UL/CSA	23	9"	5.49	4.99	3.99	2.99
195899CD	Sunon	KDE1204PKS2	12	1.60 x 1.60 x 0.80	6.5	Sleeve	70	0.9	UL/CSA/TUV	25.5	12"	7.95	7.19	5.75	4.29
75344CD	Delta	DFB0412M	12	1.60 x 1.60 x 0.80	7.3	Ball	80	0.8	UL/CSA/VDE/CE	28	4.5"	7.69	6.95	6.25	5.65
195881CD	Common Wealth	FP-108G/DC(S1)	12	1.60 x 1.60 x 0.80	7.6	Ball	160	1.92	UL/CSA/CE	32	12"	8.95	8.09	6.49	4.85
206447CD	Delta	DFB0412H	12	1.60 x 1.60 x 0.80	8.5	Ball	100	1.0	UL/CSA/VDE	32	8"	7.95	6.95	6.25	5.59
206164CD	Sunon	KDE1204PKBX-8	12	1.60 x 1.60 x 0.80	10	Ball	90	1.1	UL/TUV/CE	29.4	12"	8.95	7.95	6.95	5.95
212679CD	Sunon	KDE1245PFB3-H	12	1.80 x 1.80 x 0.40	6.1	Ball	60	0.7	UL/CUL/TUV/CE/VDE	23	12"	6.49	5.85	5.29	4.75
212687CD	Sunon	KDE1245PFB2-H	12	1.80 x 1.80 x 0.40	8.0	Ball	90	1.1	UL/CUL/TUV/CE/VDE	29	12"	6.49	5.85	5.29	4.75
212695CD	Sunon	KDE1245PFB1-H	12	1.80 x 1.80 x 0.40	9.5	Ball	110	1.4	UL/CUL/TUV/CE/VDE	33.8	12"	6.49	5.85	5.29	4.75
212644CD	Sunon	KDE1205PFB3-HG	12	2.00 x 2.00 x 0.40	8.5	Ball	60	0.7	UL/CUL/TUV/CE/VDE	26	12"	6.95	4.95	4.69	4.39
212652CD	Sunon	KDE1205PFB2-HG	12	2.00 x 2.00 x 0.40	10.6	Ball	80	1.0	UL/CUL/TUV/CE/VDE	31.5	12"	6.95	4.95	4.69	4.39
212661CD	Sunon	KDE1205PFB1-HG	12	2.00 x 2.00 x 0.40	12.5	Ball	110	1.4	UL/CUL/TUV/CE/VDE	36	12"	6.95	4.95	4.69	4.39
212628CD	Sunon	KDE1205PHB3-H	12	2.00 x 2.00 x 0.60	10.2	Ball	60	0.7	UL/CUL/TUV/CE/VDE	22.5	12"	8.95	7.95	6.95	6.25
206965CD	Adda	AD0512HB-D71	12	2.00 x 2.00 x 0.60	11.7	Ball	100	1.2	UL/CUL/TUV/CE	28.5	5"	8.95	7.95	6.95	6.25
139601CD	Adda	AD0512HS-D71	12	2.00 x 2.00 x 0.60	12	Sleeve	100	1.2	UL/CSA/CE	29	12"	8.95	8.09	7.25	6.55
206172CD	Sunon ²	KDE1205PHB2-TM	12	2.00 x 2.00 x 0.60	12.7	Ball	140	1.7	UL/CSA/CE	27.8	11"/3 leads	8.95	7.95	6.95	6.25
212636CD	Sunon	KDE1205PHB2-H	12	2.00 x 2.00 x 0.60	13	Ball	80	1.0	UL/CUL/TUV/CE/VDE	29.5	12"	8.49	7.65	6.89	6.19
147491CD	Shicoh	0610-12HH	12	2.36 x 2.36 x 0.40	16.2	Ball	150	1.8	---	38	5"	7.95	7.19	5.75	4.29
104205CD	Panaflo	FBA06T12L	12	2.36 x 2.36 x 0.60	12	Sleeve	130	1.1	---	24	6"	7.95	7.19	5.75	4.29
195944CD	Adda	AD612MS-D71GL	12	2.36 x 2.36 x 0.60	14.2	Sleeve	110	1.32	UL/CSA/TUV/CE	28.8	6"	6.95	6.29	5.05	3.79
151327CD	NMB	2406KL-04W-B40-L00	12	2.36 x 2.36 x 0.60	16	Ball	130	1.6	UL/CSA/VDE/CE	31	9"	9.49	8.55	7.69	6.95

¹ 213428CD: ATX PC type

² 206172CD: Locked rotor alarm

DC Brushless Fans continued on pages 61 & 62

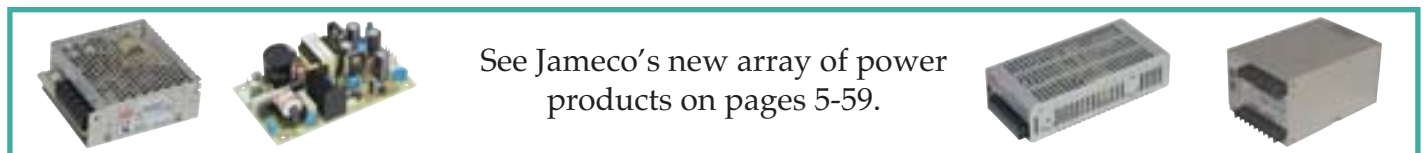

See Jameco's new array of power products on pages 5-59.

DC Brushless Fans (Continued)



Call for additional OEM PRICING – we carry major manufacturers.

- Low profile
- Ball and sleeve bearings
- Power input by lead wires or terminals
- Agency approved
- Low power consumption
- Low acoustical noise rating
- PBT black thermo plastic frame and impeller



SALE



191628CD

153411CD

Fans

Part Number	Manufacturer	Product Number	Voltage (VDC)	Size (W" x H" x D")	Air Flow (CFM)	Bearing	Current (mA)	Power (Watts)	Agency Approvals	Noise (dBA)	Connection (Leads)	Pricing			
												1	10	50	100
174941CD	Globe Motors ¹	D47-B15A-04T2-100	12	4.68 x 4.68 x 1.50	97	Ball	520	5.3	UL/CSA/TUV	40	terminals	\$3.69	\$3.35	\$2.99	\$2.69
174967CD	NMB ²	4715KL-04W-B29	12	4.68 x 4.68 x 1.50	97	Ball	520	4.8	UL/CSA/TUV/CE	40	12"/3 leads	6.95	6.29	5.05	3.79
159020CD	Sunon	KDE1212PMS1-6A	12	4.68 x 4.68 x 1.50	107	Sleeve	570	6.8	UL/CSA/TUV	41	12"	11.95	10.79	9.69	8.69
163601CD	Della (Smart Fan) ¹	WFC1212BE	12	4.68 x 4.68 x 1.50	108	Ball	650	6.6	UL/CSA/VDE	41.3	12"	10.95	9.89	7.95	5.95
94625CD	Sunon	KD1212PMB1-6A	12	4.68 x 4.68 x 1.50	108	Ball	570	6.8	UL/CSA/TUV/CE	42	12"	11.95	10.79	8.65	6.49
189851CD	Delta	WFB1212HE	12	4.68 x 4.68 x 1.50	108	Ball	490	5.9	UL/CSA/VDE/CE	41.3	12"	11.95	10.79	8.65	6.45
206201CD	Sunon	KDE2404PKB3	24	1.60 x 1.60 x 0.80	6	Ball	30	0.7	UL/CSA/TUV/CE	24	12"	7.49	6.79	6.09	5.49
100909CD	Sunon	KD2404PKS2	24	1.60 x 1.60 x 0.80	6.5	Sleeve	50	1.2	UL/CSA/TUV/CE	25.5	12"	7.95	7.19	5.75	4.19
140661CD	NMB	2408NL-05W-B60	24	2.36 x 2.36 x 0.80	18.4	Ball	100	2.4	---	31	2"	5.95	5.39	4.34	3.24
174107CD	Jamicon	JF0625S2M	24	2.36 x 2.36 x 1.00	18	Sleeve	130	3.1	UL/TUV	28.5	10"	4.95	4.49	3.59	2.69
189860CD	Jamicon	JF0625B2M	24	2.36 x 2.36 x 1.00	18	Ball	130	3.1	UL/CSA/TUV/CE	28.5	10"	7.95	7.19	6.45	5.85
227248CD	Mechatronics	F6025E24B	24	2.36 x 2.36 x 1.00	24	Ball	125	3.0	UL/CUL/TUV	36	12"	8.95	8.09	7.29	6.59
174078CD	Jamicon	JF0825S2M	24	3.15 x 3.15 x 1.00	32	Sleeve	130	3.1	UL/CUL/TUV	28	10"	4.55	4.09	3.29	2.45
162923CD	Jamicon	JF0825S2H	24	3.15 x 3.15 x 1.00	39.2	Sleeve	150	3.6	UL/CSA/TUV	31	10"	2.75	2.39	2.15	1.95
136160CD	Jamicon	JF0825B2H	24	3.15 x 3.15 x 1.00	39.2	Ball	150	3.6	UL/CSA/TUV	31	12"	9.49	8.55	7.69	6.95
189878CD	Sunon	KD2408PTB1-6A	24	3.15 x 3.15 x 1.00	42.5	Ball	220	2.6	UL/CSA/TUV/CE	36.5	12"	9.95	8.99	7.19	5.39
191628CD	Roltron Comair ³	WT24B6X	24	3.15 x 3.15 x 1.25	15	Ball	190	4.6	---	51.4	21"	16.95	15.29	12.25	9.19
189886CD	NMB	3610KL-05W-B30	24	3.63 x 3.63 x 1.00	40.6	Ball	87	2.1	UL/CSA/VDE	34	12"	7.95	7.19	5.75	4.29
174094CD	Jamicon	JF0925S2H	24	3.63 x 3.63 x 1.00	52	Sleeve	190	4.6	UL/CUL	37	10"	7.95	7.19	5.75	4.35
206210CD	Sunon	KDE2412PTS3-6A	24	4.68 x 4.68 x 1.00	67	Sleeve	130	3.1	UL/CSA	35	12"	9.95	8.99	8.09	7.25
175281CD	Globe Motors	D47B10A05W2000	24	4.68 x 4.68 x 1.00	70	Ball	160	2.9	UL/CSA/TUV/CE	34	12"	12.95	11.69	9.35	6.99
206228CD	Sunon ⁴	KDE2412PMS1-6A	24	4.68 x 4.68 x 1.00	107	Sleeve	310	7.4	UL/CSA/TUV/CE	41	11"/3 leads	14.95	13.95	12.95	11.95
100968CD	Sunon	KDE2412PMB3-6A	24	4.68 x 4.68 x 1.50	83	Ball	140	3.4	UL/CSA/TUV/CE	35	12"	12.95	11.69	9.35	6.99
153411CD	Sunon	KD2412PMB2-6A	24	4.68 x 4.68 x 1.50	98	Ball	230	5.5	UL/CSA/TUV	36.5	12"	12.59	11.35	10.25	9.19
166730CD	Mechatronics	A9225H48B	48	3.63 x 3.63 x 1.00	51	Ball	100	4.8	UL/CSA/TUV	36	13"	8.79	7.85	6.99	6.19
175468CD	NMB	5920PL-07W-B30	48	6.75 x 5.90 x 1.50	210	Ball	400	14.4	UL/CSA	51	12.5"	7.59	6.85	6.15	5.55
196710CD	PABST ⁵	7118N/12	48	6.75 x 5.90 x 1.50	212	Ball	250	12	UL/CSA/VDE/CE	55	13"/3 leads	6.45	5.85	5.35	4.85

¹ 174941CD: Locked rotor protected ² 174967CD: Locked rotor alarm ³ 191628CD: Blower ⁴ 206228CD: Locked rotor alarm ⁵ 196710CD: Speed sensor † Temperature control: 35°C

AC Tube Axial Fans

Call for additional OEM PRICING – we carry major manufacturers.



111915CD



16977CD



- Rating 115 & 220VAC @ 50-60Hz
- Low acoustical noise rating
- Agency approved fans
- Ball and sleeve bearings
- Air flow from 10.2 to 226 CFM



102904CD



75432CD

Part Number	Manufacturer	Product Number	Voltage (VAC)	Size (W" x H" x D")	Air Flow (CFM)	Bearing	Current (mA)	Power (Watts)	Agency Approvals	Noise (dBA)	Connection (Leads)	Pricing			
												1	10	50	100
162704CD	Toyto	USTF60301153W	115	2.36 x 2.36 x 1.18	11	Ball	38	4	UL/CSA/CE	29	12" leads	\$15.95	\$14.39	\$12.95	\$11.65
213866CD	Fulltech	UF60D11H	115	2.36 x 2.36 x 1.18	10.2	Ball	35	4	UL/CUL/VDE/CE	28	12" leads	15.95	14.39	12.95	11.65
146077CD	Common Wealth	FP108AX-S1-B	115	3.15 x 3.15 x 1.00	23	Ball	140	14	UL/CE	29	12" leads	14.95	13.49	12.15	10.95
75408CD	Fulltech	UF80B12SWH	115	3.15 x 3.15 x 1.00	24	Sleeve	140	14	UL/CSA/TUV/CE	35	12" leads	14.95	13.49	12.15	10.95
212610CD	Fulltech	UF80B12BTH	115	3.15 x 3.15 x 1.00	24	Ball	140	14	UL/CSA/TUV/CE	35	terminals	12.95	11.95	10.95	9.95
111915CD	Fulltech	UF80A12SWL	115	3.15 x 3.15 x 1.50	25	Sleeve	110	12	UL/CSA/TUV/CE	32	12" leads	11.95	10.95	9.95	8.95
16977CD	Fulltech	UF80A12BWL	115	3.15 x 3.15 x 1.50	25	Ball	110	11	UL/CSA/TUV/CE	32	12" leads	13.95	12.59	11.35	10.19
16969CD	Fulltech	UF80A12BTL	115	3.15 x 3.15 x 1.50	25	Ball	110	12	UL/CSA/TUV/CE	32	terminals	14.95	11.99	8.99	8.59
102904CD	Fulltech	UF80A12BWH	115	3.15 x 3.15 x 1.50	29	Ball	120	12	UL/CSA/TUV/CE	36	12" leads	14.95	13.49	12.15	10.95
212601CD	Fulltech	UF80A12BTH	115	3.15 x 3.15 x 1.50	30	Ball	120	12	UL/CSA/TUV/CE	36	terminals	13.95	12.95	11.95	10.95
191564CD	Nidec	TA300AC-AC30477	115	3.15 x 3.15 x 1.50	32	Ball	104	9	UL/CSA/TUV	51	terminals	15.95	12.79	9.59	6.75
75432CD	Sunon	SF11592A-1092HSL	115	3.63 x 3.63 x 1.00	36	Sleeve	130	12	UL/CSA/TUV/CE	39	12" leads	14.95	13.49	12.15	10.95
75459CD	Sunon	SF11592A-1092HBT	115	3.63 x 3.63 x 1.00	37	Ball	110	12	UL/CSA/TUV/CE	40	terminals	15.95	14.39	12.95	11.65

Order Anytime 24x7x365

Phone 1-800-831-4242

Fax 1-800-237-6948

AC Tube Axial Fans

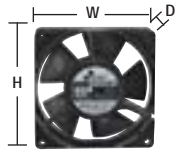

Call for additional OEM PRICING – we carry major manufacturers.

- Rating 115 & 220VAC @ 50-60Hz
- Low acoustical noise rating
- Agency approved fans
- Ball and sleeve bearings
- Air flow from 11 to 226 CFM



Part Number	Manufacturer	Product Number	Voltage (VAC)	Dimensions (W" x H" x D")	Air Flow (CFM)	Bearing	Current (mA)	Power (Watts)	Agency Approvals	Noise (dBA)	Connection (Leads)	Pricing			
												1	10	50	100
124062CD	Sunon	SP101AT1122HBT	115	4.68 x 4.68 x 1.00	78	Ball	180	18	CSA/TUV/CE	46	terminals	\$14.95	\$13.49	\$12.15	\$10.95
118965CD	Fulltech	UF12A12BTL1	115	4.68 x 4.68 x 1.50	64	Ball	80	15	UL/CSA/TUV/CE	37	terminals	14.95	13.49	12.15	10.95
109874CD	Fulltech	UF12A12STL	115	4.68 x 4.68 x 1.50	81	Sleeve	150	15	UL/CSA/TUV/CE	38	terminals	12.95	11.69	10.55	9.49
111894CD	Common Wealth	FP108-1-S1/W	115	4.68 x 4.68 x 1.50	105	Sleeve	180	17	UL/CSA/CE	47	12" leads	13.95	12.59	11.35	10.19
106585CD	Common Wealth	FP108-1-S1/T	115	4.68 x 4.68 x 1.50	105	Sleeve	180	12	UL/CSA/CE	47	terminals	14.95	13.49	12.15	10.95
16934CD	Common Wealth	FP108-1-S1-B	115	4.68 x 4.68 x 1.50	105	Ball	200	17	UL/CSA/TUV/CE	47	terminals	16.95	15.29	13.75	12.39
212599CD	Fulltech	UF12A12BWH	115	4.68 x 4.68 x 1.50	106	Ball	190	15	UL/CSA/TUV/CE	46	12" leads	12.95	11.95	10.95	9.95
206308CD	Adda	AA1281UB-AT	115	4.68 x 4.68 x 1.50	107	Ball	230	24	CE	48	terminals	14.95	13.49	12.15	10.95
102883CD	Sunon	SP100A-1123XBT	115	4.68 x 4.68 x 1.50	117	Ball	240	20	UL/CSA/TUV/CE	50	terminals	14.95	13.95	12.95	11.95
108724CD	Fulltech	UF15AC12BTH	115	6.75 x 5.90 x 1.50	211	Ball	230	28	UL/CSA/TUV/CE	58	terminals	29.95	26.95	23.95	21.49
212564CD	Fulltech	UF15PC12BTL	115	6.75 x 5.90 x 2.00	113	Ball	260	30	UL/CSA/TUV/CE	41	terminals	27.95	25.19	22.65	20.39
212572CD	Fulltech	UF15PC12BWL	115	6.75 x 5.90 x 2.00	113	Ball	260	30	UL/CSA/TUV/CE	41	12" leads	29.95	26.95	23.95	21.49
212581CD	Fulltech	UF15PC12BWH	115	6.75 x 5.90 x 2.00	226	Ball	250	30	UL/CSA/TUV/CE	58	12" leads	29.95	26.95	23.95	21.49
189683CD	Fulltech	UF15PC12BTH	115	6.75 x 5.90 x 2.00	226	Ball	250	30	CSA	58	terminals	29.95	26.95	24.29	21.79
174932CD	NMB	3115FS-23T-B10	220	3.15 x 3.15 x 1.50	25	Ball	30	4.6	UL/CSA/TUV/CE	25	terminals	12.99	11.69	9.35	6.99
100917CD	Sunon	SF23080A/2083HSL	220	3.15 x 3.15 x 1.50	30	Sleeve	60	13.5	UL/CSA/TUV/CE	35	12" leads	13.95	12.59	10.09	7.59
209365CD	Innovative	4C-230LB	220	4.68 x 4.68 x 1.50	63	Ball	60	9	TUV/CE	34	10" leads	12.95	11.69	10.49	9.45
102891CD	Sunon	DP200A-2123XBT	220	4.68 x 4.68 x 1.50	117	Ball	120	21	UL/CSA/TUV/CE	50	terminals	15.95	14.39	12.95	11.65

Fan Guards, Filters & Cords

Compatible with DC and AC Fans – pages 60 - 63

- All guards and filters fit all fans by matching the size dimension.
Example: P/N 75408CD fan (3.15") matches P/N 31923CD metal guard (3.15").



123502CD



120037CD



31923CD/123511CD



25734CD



138561CD/196816CD



138579CD/192874CD
130104CD

Part No.	Description	1	10	100	250
123502CD	1.60" metal (chrome) guard	\$.63	\$.49	\$.42	\$.39
163432CD	2.00" metal (chrome) guard	.79	.71	.64	.58
120037CD	2.36" metal (chrome) guard	.99	.85	.69	.59
31923CD	3.15" metal (chrome) guard	.79	.65	.52	.49
123511CD	3.63" metal (chrome) guard	.89	.75	.59	.55
25734CD	4.68" metal (chrome) guard	1.09	.89	.69	.65
138561CD	3.15" plastic guard with mesh	1.39	1.19	1.05	.95
196816CD	4.68" plastic guard with mesh	1.95	1.75	1.49	1.25
138579CD	3.15" alum. washable filter	2.95	2.65	2.39	2.15
192874CD	3.63" alum. washable filter	1.85	1.65	1.49	1.35
130104CD	4.68" alum. washable filter	3.49	3.25	2.95	2.65

Fan Power Cords: 24" Straight and Right-Angle

- Cord type: SPT-1 (2) conductor black • Voltage rating: 300V • Temperature range: 60°C • Fits all terminal fans

Part No.	Description	Length	1	10	100	250
28564CD	Straight socket cord	24"	\$.89	\$.75	\$.69	\$.65
104192CD	90° angle socket cord	24"	1.19	1.09	.96	.87



28564CD



104192CD

CPU Heat Sinks and Fans

See page 77 for Heat Sink Compounds



- Excellent for avoiding CPU overheating during extended system on-time
- High efficiency cooling fans
- Easy installation – just snap it in

See page 171 for detailed specifications and prices!

12-Bit Analog/Digital DAC and Stepper Motor Control Board

- High speed serial port interface up to 230.4kbps
- 4 channels with precision signal conditioning – 100mV, 2.5V and 5.0V inputs
- 24 digital I/O (TTL) and 11 analog channels with 12-bit resolution
- PWM, period measurement and stepper motor functions
- Free 32-bit DLL, OCX and Labview driver for rapid system development
- Size: 6.0"L x 2.6"W • Weight: 0.7 lbs.

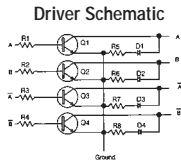

SALE

Requires: External driver circuit parts kit (P/N 208573CD, below) – consisting of 5 ea. 1kΩ 1/4W resistors, 5 ea. 330Ω 1/4W resistors, 5 ea. MJE 3055T transistors, and 5 ea. 1N4003 diodes

Part No.	Description	1	10
109911CD	Analog/digital DAC board....	\$129.95	\$116.99
208573CD	Unipolar circuit parts kit	3.49	3.15

PONTECH Servo Controller Board

- Controls 1 to 8 servos per board, 8-bit precision
- Interface to PC through RS-232 port @ 2400-19,200bps
- 5 channel, 8-bit A/D input port for reading 0 to 5V
- IR-receiver & transmitter feature
- Source/sink: 25mA per pin • 8k EEPROM
- Size: 1.7"L x 1.4"W (main board); 1.1"L x 0.9"W (infrared board)



Includes: Manual, supplement & sample code software

Part No.	Description	1	10
153648CD	Servo controller board	\$89.95	\$80.95

Scott Edwards Electronics, Inc.

Mini SSC II Module (Serial Servo Controller)

- Controls 8 pulse-proportional servos
- Receives serially at 2400 or 9600 baud
- Module is addressable, allowing two units to share the same line to control a total of 16 servos
- Connections to serial input can be established using a modular jack (P/N 115553CD, pg 195) or modular adapter from DB9 to RJ11 (P/N 114737CD, pg 195)
- Size (PCB): 1.9"L x 1.4"W • One-year warranty



Part No.	Description	1	10
151001CD	Serial servo controller module	\$49.95	\$42.95



32-Bit Stepper Motor Controller

One Axis

- Controls one bipolar stepper motor with 32-bit absolute position
- Interface to PC through RS232 or RS485 @ 2400-19,200 bps
- Full, half or wave step modes
- Multiple boards may share same serial line (RS485 only)
- 2 channel general purpose 8-bit A/D input port for reading 0 to 5V
- 4-bit digital input for home limits
- Addressable up to 255 boards
- Size: 4.4"L x 2.3"H • Weight: 0.7 lbs.



Part No.	Description	1	10
153621CD	32-bit controller	\$159.95	\$149.95

rmv electronics Multi-Stepper Motor Control Board

- Simultaneous/independent control of up to 16 stepper motors through a single serial port
- High speed serial communication interface 9.6kbps-230.4kbps
- 11 analog channels, A/D converter, 10 or 12 bits resolution
- 24-bit position register; can be read while motor is moving
- Linear acceleration/deceleration capability up to 8500 step/sec.
- Full step (monophasic and biphasic), half step and external driver modes
- Current-mode coil driver up to 2A/45V
- Automatic power down prevents motor overheating
- External driver control outputs: step, direction and power control
- 26 digital I/O and two SPI interfaces for control of external devices
- 32 bits DDL interface for Windows® 9X, NT & Linux
- Internal FIFO RAM (128 bytes) allows customized motion profiles
- Size: 7.7"L x 5.0"W x 1.0"H • Weight: 0.7 lbs.

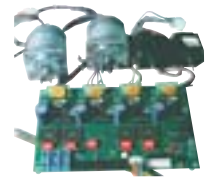

Shown w/ motors – not included

Part No.	Description	1	10
168727CD	Stepper motor control brd	\$399.95	\$379.95



Don't worry about backorders. Over 99% of our products are in stock!

We'll Send It Today!

Just place your order by 6PM EST for same business day shipment

KAE

Industrial Motion Controllers for Brush, Brushless and Stepper Motors

All JR Kerr Automation Engineering controllers include integrated power amplifiers. Up to 32 controllers can be daisy-chained from a single full-duplex RS485 port. For RS-232 to RS-485 adapter see P/N 184971CD (below).

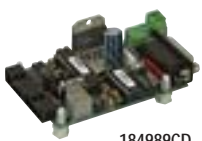

184989CD



185009CD



184971CD

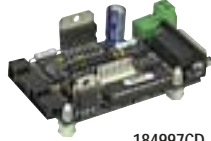

184997CD



184962CD



184954CD

184989CD: PIC-SERVO motor control board

- For brush-type DC motors with 2 or 3 channel incremental encoders
- P.I.D. Servo control, trapezoidal position profiling, velocity mode, 32-bit resolution
- Integrated 12 to 48VDC supply power amplifier @ 3A continuous, 6A peak
- Limit switch inputs, general purpose analog input, PWM, DIR output for use with external amps

185009CD: PIC-SERVO 3PH motor control board for brush or brushless motors

- For 3-phase brushless motors with hall effect sensors or conventional DC brush-type motors
- High current amplifier: 7A continuous, 10A peak, 12 to 48VDC supply
- Same features as 184989CD above but with support for linear & circular interpolation using the PIC-SERVO CMC chipset

184971CD: Z232-485 serial port adapter

- Lets you operate the controllers above from any standard RS-232 port

Part No.	Description	Size (L" x W" x H")	1	10
184989CD	PIC-SERVO	3.1 x 2.1 x 0.9	\$179.95	\$161.95
185009CD	PIC-SERVO 3PH	3.1 x 3.1 x 1.0	239.95	215.95
184971CD	Z232-485	3.1 x 2.1 x 0.5	59.95	53.95

184997CD: PIC-STEP motor control board

- Integrated indexer and driver for 2 or 4 phase stepper motors
- Full/half step bipolar chopper drive, 2A per phase, 7.5 to 46VDC supply
- Trapezoidal position profiling, velocity mode, up to 50,000 steps per second
- Limit switch inputs, general purpose outputs, step/dir outputs for use with external drivers

184962CD: PIC-I/O multifunction I/O control board

- 12 I/O bits software configurable as inputs or outputs
- One counter input
- Three 8-bit analog inputs, two PWM outputs with high current drivers

184954CD: Simple sequencer stand-alone controller

- Programmable master controller for building stand-alone systems with the controllers above
- Plugs into a socket on the Z232-485 board (P/N 184971CD, left)

Part No.	Description	Size (L" x W" x H")	1	10
184997CD	PIC-STEP	3.1 x 2.1 x 0.9	\$159.95	\$143.95
184962CD	PIC-I/O	3.1 x 2.1 x 0.6	99.95	89.95
184954CD	Simple sequencer	2.1 x 1.0 x 0.4	59.95	53.95

12VDC Bipolar Stepper Motor

3.6° / Step

- No. of phases: 2
- Detent torque: 80 g-cm
- Holding torque: 600 g-cm
- Phase resistance: 25Ω
- Phase inductance: 31mH
- Current: 480mA
- Mounting hole size: 0.11"
- Shaft size: 0.43"L x 0.197"Dia.
- Motor size: 1.66"Dia. x 1.31"H



12VDC Geared Unipolar Stepper Motor

.09° / Step

- No. of phases: 4
- Detent torque: 400 g-cm
- Holding torque: 400 g-cm
- Phase resistance: 200Ω
- Phase inductance: 49.5mH
- Current: 60mA
- Mounting hole size: 0.14"
- Shaft size: 0.36"L x 0.194"Dia.
- Motor size: 1.18"Dia. x 0.68"H



5VDC Unipolar Stepper Motor

7.5° / Step

- No. of phases: 4
- Detent torque: 90 g-cm
- Holding torque: 750 g-cm
- Phase resistance: 9Ω
- Phase inductance: 10mH
- Current: 550mA
- Mounting hole size: 0.13"
- Shaft size: 0.40"L x 0.117"Dia.
- Motor size: 1.65"Dia. x 0.83"H



Part No.	Mfr. Cross Ref. No.	1	10	50
105881CD	SM4203	\$6.49	\$5.85	\$5.29

Part No.	Mfr. Cross Ref. No.	1	10	50
173180CD	30BYJ02AH	\$12.99	\$11.69	\$10.49

Part No.	Mfr. Cross Ref. No.	1	10	50
151861CD	C42M048A04	\$6.19	\$5.59	\$5.05

Bipolar and Unipolar Stepper Motors



Fig. 1 Fig. 2 Fig. 3 Fig. 4 Fig. 5 Fig. 6 Fig. 7 Fig. 8

- Excellent for precision control
- Can be operated in forward/reverse mode
- See pages 6-11 for compatible power supplies

Part Number	Mfr. Cross Ref. No.	Fig.	Step Angle	No. of Phases	Drive System	Volt. (VDC)	Phase Resis. (Ohms)	Curr. (mA)	Phase Inductance (mH)	Detent Torque (g-cm)	Holding Torque (g-cm)	Mounting Hole Space Diagonal (in.)	Mounting Holes (in.)	Shaft Dia. (in.)	Shaft Length (in.)	Motor Dia. (in.)	Motor Height (in.)	Pricing		
																		1	10	50
117954CD	LB82773-M1	1	7.5°	2	Bipolar	5	6	800	7	100	1080	2.60	1.95	0.250	0.75	2.25	1.00	\$4.29	\$3.89	\$3.09
163395CD	5017-935 ¹	2	0.9°	2	Bipolar	8.4	30	280	25	36	791	1.73	0.15	0.155	0.29	1.64	1.20	5.59	4.79	3.59
163408CD	4017-806 ¹	2	1.8°	2	Bipolar	9.2	38	240	52	36	664	1.73	0.15	0.155	0.23	1.66	1.25	2.49	2.15	1.65
105881CD	SM4203 ^{2/3}	3	3.6°	2	Bipolar	12	25	480	31	80	600	1.73	0.11	0.197	0.43	1.66	1.31	6.49	5.85	5.29
164056CD	M82101-P1	1	7.5°	3	Unipolar	5	20	255	5	9	94	1.4	0.13	0.078	0.35	1.00	0.46	1.85	1.69	1.55
151861CD	C42M048A04	4	7.5°	4	Unipolar	5	9	550	10	90	750	1.94	0.13	0.117	0.40	1.65	0.83	6.19	5.59	5.05
171601CD	PF35T48L4 ⁴	1	3.6°	4	Unipolar	7	20	350	9	40	680	1.68	0.14	0.078	0.47	1.38	0.58	4.99	4.25	3.19
166705CD	PM42S-096	1	3.8°	4	Unipolar	12	84	140	16	60	450	1.95	0.13	0.117	0.40	1.66	1.64	3.95	3.39	2.55
213321CD	35BY48-27	7	7.5°	4	Unipolar	12	15	800	68	90	460	1.96	0.13	0.078	0.25	1.38	8.30	12.95	11.69	10.49
173180CD	30BYJ02AH ⁵	6	.09°	4	Unipolar	12	200	60	49.5	400	400	1.42	0.14	0.194	0.36	1.18	0.68	12.99	11.69	10.49
192794CD	PM425048 ⁶	5	7.5°	4	Unipolar	24	45	500	17.5	39	570	1.97	0.09	0.117	0.33	1.66	0.54	2.05	1.85	1.69
210382CD	5620	1	7.5°	4	Unipolar	24	100	436	60	40	380	1.67	0.13	0.078	0.40	1.38	0.58	4.95	4.49	4.05
210391CD	STP42N196S	8	3.75°	4	Unipolar	24	110	436	60	60	600	1.95	0.13	0.118	0.42	1.65	0.54	4.95	4.49	4.05

¹ 163395CD/163408CD: Dual shaft

² 105881CD: P/N 25216CD (IC, MC3479P, pg 76) biphaser stepper motor driver can be used to operate

³ 105881CD: Use P/N 161998CD for shaft coupler, see page 204

⁴ 171601CD: Dual shaft w/ 10 tooth gear

⁵ 173180CD: Motor step angle 7.5°; gear ratio 85.25:1

⁶ 192794CD: Single shaft w/ 12 tooth gear

GBM Bipolar and Unipolar Stepper Motors

- Bearing type: ball
- Dielectric strength: 500V, 50Hz/minute
- 18" lead wires
- Step angle: 1.8°
- Ambient temperature: -10°C to +55°C
- Insulation resistance: 100MΩ @ 500VDC
- Use P/N 161998CD, pg 204, for shaft coupler

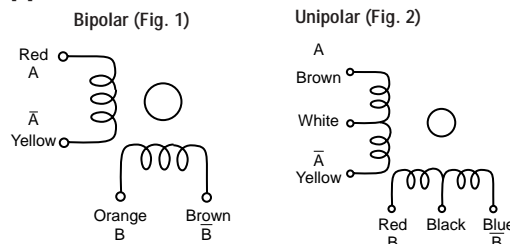

GBM is an ISO-9001 Certified Company



Part Number	Product Number	Fig.	NEMA† Form	No. of Phases	Drive System	Voltage (VDC)	Phase Resistance (Ohms)	Current (mA)	Phase Inductance (mH)	Detent Torque (g-cm)	Holding Torque (g-cm)	Mounting Hole Space Diagonal (in.)	Mounting Holes (in.)	Shaft Diameter (in.)	Shaft Length (in.)	Motor Diameter (in.)	Motor Height (in.)	Weight (lbs.)	Pricing		
																			1	10	50
224021CD	42BYG016	2	17	4	Unipolar	12	75	160	54	200	900	1.73	0.1	.197	0.7	1.7	1.3	0.5	\$16.95	\$15.25	\$13.75
155459CD	42BYG023*	1	17	2	Bipolar	12	30	400	36	220	2,100	1.73	0.1	0.197	0.6	1.7	1.3	0.5	17.95	16.29	14.59
172646CD	42BYG205	2	17	4	Unipolar	9.6	75	480	15	220	2,300	1.73	0.1	0.197	0.9	1.7	1.4	0.5	17.95	16.19	14.55
155432CD	42BYG228	2	17	4	Unipolar	12	30	400	23	220	2,000	1.73	0.1	0.197	0.9	1.7	1.5	0.5	17.95	16.29	14.59
162026CD	57BYG084	2	23	4	Unipolar	12	20	600	22	725	6,000	2.65	0.2	0.250	1.0	2.2	2.0	1.3	26.95	24.29	21.85
223870CD	57BYG070	2	23	4	Unipolar	5.4	3.6	1500	6.0	980	9,000	2.65	0.2	0.250	0.8	2.2	2.2	2.0	49.95	44.95	40.49

* dual shaft



3-150VDC Motors

MITSUMI

NMB

NICHIBO MOTOR

star motor

JOHNSON ELECTRIC



154915CD/154923CD



211246CD



177498CD



181411CD



192807CD



153656CD



174991CD



181112CD



174692CD



162579CD



206949CD



181964CD

Part Number	Manufacturer Cross Reference No.	Manufacturer	Nominal Voltage (VDC)	Voltage Range (VDC)	Current (Amps)	RPM (max.)	Torque (g-cm)	Terminal Type	Shaft Dia.	Shaft Length	Size (D" x L")	Pricing		
												1	10	100
154915CD	ST-130-12240 ¹	Star Motor	3	1.5-3	0.070	5200	4.0	.09"/solder	0.08"	0.32"	0.79 x 1.13	\$1.29	\$1.09	\$.84
154923CD	ST-130-22770 ¹	Star Motor	3	1.5-3	0.240	16000	8.3	.09/solder	0.08"	0.32"	0.79 x 1.13	.99	.89	.79
211246CD	RC-260RA-2670	Mabuchi	4.5	3.0-4.5	0.30	18500	21.8	0.11"/Solder	0.08"	0.28"	0.93x1.06	1.95	1.75	1.59
177498CD	RC280RA-2485	Mabuchi Motor	4.5	3-14	0.150	10300	33.3	11"/solder	0.08"	0.43"	0.95 x 1.20	1.75	1.55	1.39
181411CD	HC685G-61810	Johnson Electric	5.0	3-14	0.470	10000	18.8	.187"/solder	0.13"	0.54"	1.40 x 1.98	2.95	2.55	1.89
192807CD	RF500TB	Mabuchi Motor	6.0	1.5-9	0.028	3700	14.5	.08"/solder	0.08"	0.35"	1.25 x 0.76	1.99	1.69	1.29
153656CD	RS550PF ²	Mabuchi Motor	12	6-15	1.400	6500	44.1	.15"/solder	0.13"	0.66"	1.45 x 2.25	3.29	2.99	2.69
174991CD	6424CL09WB20	NMB	10	8-12	0.430	4100	—	8" wires	0.12"	0.64"	1.62 x 0.64	1.85	1.65	1.49
181112CD	M25N-2	Mitsumi	12	5-15	0.018	3000	18	11"/solder	0.08"	0.26"	0.97 x 1.30	1.99	1.69	1.29
174692CD	21226-384221	Johnson Electric	12	9-14	0.015	3000	—	.11"/solder	0.08"	0.69"	0.97 x 1.19	1.65	1.49	1.35
162579CD	TID20E	Operating Tech T&I	12	9-14	0.025	2150	—	.20"/solder	0.12"	0.48"	1.48 x 1.42	1.55	1.29	.99
206949CD	QJT360S14280	Nichibo	12	9-30	0.350	4930	44.5	.11"/solder	0.09"	0.45"	1.09 x 1.30	1.69	1.45	1.09
181964CD	NF203G12	Johnson Electric	12	9-14	0.030	5000	—	.07"/solder	0.08"	0.57"	0.95 x 1.20	1.55	1.29	.99
173681CD	HC610F ³	Johnson Electric	12	9-14	0.950	6600	20.0	.187"/fast on	0.12"	0.92"	1.40 x 1.80	1.69	1.55	1.39
190035CD	HC685L	Johnson Electric	15	7.2-24	0.720	7800	23.2	.187"/solder	0.13"	0.38"	1.47 x 2.25	1.49	1.35	1.19
161082CD	84055	Johnson Electric	150	145-152	0.168	6500	305.9	.187"/fast on	0.16	0.55"	2.48 x 1.51	1.45	1.29	1.19

¹ 154915CD/154923CD: Use bushing P/N 162392CD, pg 204

² Manufacturer may vary

³ 173681CD: Eccentric gear



173681CD



190035CD



161082CD

Vibrating Motors

1.3VDC 8,500 RPM Vibrating Motor

- Typical applications: cellular phones, pagers, and toys
- Rated RPM: 8,500 @ 1.3VDC
- Direction of rotation: clockwise
- Operating voltage: 1.3V @ 65mA (typical)
- Lead length: 0.75"
- Size: (motor) 0.16"Dia. x 0.55"L (shaft) 0.15"Dia. x 0.23"L



Part No.	Description	1	10	100
175396CD	Vibrating motor	\$6.49	\$5.89	\$5.29

3VDC 4,500 RPM Vibrating Motor

- Typical applications: beepers, small toys, cellular phones
- Rated RPM: 4,500 or more @ 3VDC
- Direction of rotation: dual
- Operating voltage: 3VDC @ 45mA
- Operating voltage range: 2.5 – 3.8VDC
- Starting current @ operating voltage: 60mA or less
- Size: 0.55"Dia. x 0.13"Thick



Part No.	Description	1	10	100
185228CD	Vibrating motor	\$3.35	\$2.99	\$2.69

Electric Motors and Control Techniques

TAB Publishing

Explains how different types of motors operate, and how electronic control devices can be used to improve efficiency in a wide range of applications. (294 pages, 1994)



• Size: 7.3" x 9.2" • Weight: 1.1 lbs.

Part No.	Description	1	10
137162CD	Electric Motors & Control ...	\$19.99	\$17.99

1.3VDC 7,500 RPM Vibrating Motor

- Typical applications: cellular phones, pagers and toys
- Rated RPM: 7,500 @ 1.3VDC
- Clock-wise rotation
- 1.1" lead wires
- Operating voltage: 1.3VDC @ 80mA
- Size: (motor) 0.47"L x 0.24"Dia. (shaft) 0.22"L x 0.10"Dia.



Part No.	Description	1	10	100
190078CD	Vibrating motor	\$5.95	\$5.35	\$4.79

1.3VDC 7,000 RPM Vibrating Motor

- Typical applications: cellular phones, pagers, and toys
- Rated RPM: 7,000 @ 1.3VDC
- Lead length: 0.7"
- Stall current: 112mA @ 1.3VDC
- Direction of rotation: clockwise
- Operating voltage: 1.3VDC @ 62mA
- Operating voltage range: 0.7 – 1.6VDC
- Size: (motor) 0.28"Dia. x 0.67"L (shaft) 0.10"Dia. x 0.18"L



Part No.	Description	1	10	100
175062CD	Vibrating motor	\$4.95	\$4.49	\$3.95

See page 207 for our selection of Motor Kits.

Jameco's Low-Price Guarantee

We'll match the advertised price of any like product. It's that simple!



12 and 24VDC Reversible Gear Head Motors

- Solder-type terminal
- High torque construction
- Oil bearing design for long service life
- Insulation resistance: 10MΩ
- Dielectric strength: 300VDC



167038CD



159417CD



155011CD

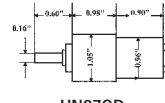

HN27GD Series

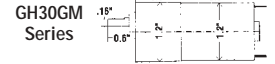

HN27GD Series

Part Number	Product Number	Rated Voltage (VDC)	Operating Range (VDC)	No Load		Started Torque (kg-cm)	Gear Ratio	Gear Size Dia. x Lgth (in.)	Motor Size Dia. x Lgth (in.)	Shaft Size Dia. x Lgth (in.)	Pricing		
				Current (mA)	Speed (rpm)						1	10	50
167038CD	GH12-0953Y	12	4.5 - 24	45	14	1.2	188:1	1.0 x 0.9	1.1 x 1.0	.16 x .60	\$16.49	\$14.85	\$13.39
167046CD	GH12-1828Y	12	4.5 - 24	95	37	1.3	90:1	1.1 x 1.3	1.1 x 0.8	.16 x .60	21.95	19.79	17.79

GH30GM Series

170641CD	GH12-1828Y-10	12	6.0 - 24	45	10	3.5	332:1	1.2 x 1.2	1.2 x 0.9	.16 x .70	\$23.95	\$21.59	\$19.49
153437CD	GH12-1045Y	12	3.0 - 12	35	15	0.8	200:1	0.9 x 1.0	1.1 x 0.6	.16 x .70	18.95	17.09	15.35
159417CD	GH12-1921Y	12	4.5 - 12	150	42	8	132:1	1.2 x 1.2	1.2 x 0.9	.16 x .70	21.95	19.79	17.79
162190CD	GH12-1324Y225	12	4.5 - 12	65	225	0.7	30:1	1.0 x 0.9	1.1 x 0.6	.16 x .70	16.95	15.25	13.75

GH35GM Series

155011CD	GH12-1926	12	4.5 - 12	55	2	15	3000:1	1.3 x 0.9	1.5 x 1.1	.23 x .90	\$21.95	\$19.79	\$17.79
155820CD	GH12-1830Y-P	12	4.5 - 12	50	4.5	13	1000:1	1.3 x 0.9	1.5 x 1.0	.23 x .90	21.95	19.79	17.79
155838CD	GH12-1641T-L	12	3.0 - 12	65	20	10	270:1	1.3 x 0.9	1.5 x 0.8	.23 x .90	23.95	21.59	19.45
152910CD	GH12-1926Y	12	4.5 - 12	48	44	11.8	100:1	1.3 x 1.0	1.5 x 0.7	.24 x .90	21.95	19.75	17.75
151440CD	GH12-1632TI	12	4.5 - 12	75	69	11	100:1	1.3 x 0.9	1.5 x 0.7	.23 x .90	21.95	18.55	16.69
155854CD	GH12-1641T-F	12	3.0 - 12	65	87	7	60:1	1.3 x 0.9	1.4 x 0.9	.23 x .90	21.95	19.79	17.79
155862CD	GH12-1926Y-F	12	4.5 - 12	60	100	5	60:1	1.3 x 0.9	1.4 x 0.9	.23 x .90	21.95	19.79	17.79
161373CD	GH12-1345T	12	4.5 - 12	69	150	3	30:1	1.3 x 0.9	1.5 x 0.7	.23 x .90	23.95	21.59	19.45
161381CD	GH12-1634T	12	4.5 - 12	111	200	3.6	30:1	1.3 x 0.9	1.4 x 0.7	.23 x .90	21.95	19.79	17.79
164785CD	GH12-1640Y	12	4.5 - 24	45	300	0.8	10:1	1.3 x 0.9	1.4 x 0.7	.23 x .90	23.95	21.59	19.45
176049CD	GH12-1640Y00	24	12 - 24	140	2	6	3000:1	1.3 x 0.9	1.5 x 1.1	.23 x .90	22.95	19.55	15.59
176031CD	GH24-1640Y06	24	12 - 24	140	65	2	90:1	1.3 x 0.9	1.4 x 0.7	.23 x .90	21.95	19.79	17.79
176022CD	GH24-1640Y19	24	12 - 24	140	193	1.0	30:1	1.3 x 0.9	1.4 x 0.7	.23 x .90	21.95	19.79	17.79

Solenoids and AC Gear Motor

12VDC Continuous Tubular Push, Pull and Push/Pull Solenoids

- 12VDC nominal voltage continuous
- Life expectancy: 2,000,000 cycles

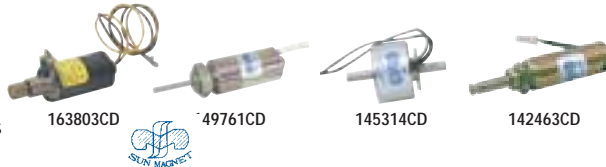

Part No.	Type	Coil Res. (±10%)	Power Consum.	Holding Force (lbs. @ 20°C)	Wires (in.)	Size (ins.) (L x Dia.)	Shaft Dia. (in.)	Wt. (lbs.)	Pricing		
									1	10	100
163803CD	Push*	42.8Ω	3.4W	0.75	9.0	2.00 x .60	0.156	0.10	\$6.95	\$6.29	\$5.65
149753CD	Push	36Ω	4.0W	0.75	7.0	1.90 x .50	0.063	0.05	9.95	8.95	7.95
149761CD	Push	20.7Ω	7.0W	1.50	7.0	2.50 x .60	0.098	0.10	9.95	8.95	7.95
145314CD	Push/Pull	89Ω	2.0W	1.12	3.5	1.24 x .73	0.110	0.05	8.95	7.95	6.95
142463CD	Pull	36Ω	4.0W	0.63	2.0	1.63 x .43	0.150	0.04	5.95	5.35	4.79

* Guardian Mfr. # A420-067074-1

Shindengen 24VDC Continuous Tubular Pull Solenoid

- Holding force: 3 lbs.
- Typical coil resistance: 131Ω
- Power: 8 watts
- 2" lead wires
- Size: 3.1"L x 1.0"Dia.
- Weight: 2.8 lbs.



Part No.	Description	1	10	100
128575CD	24VDC solenoid	\$8.49	\$7.65	\$6.89

12VDC Solenoid Valve

- Operating voltage: 12VDC
- Operational temperature: -29°C to 85°C
- Current: 350mA
- Air leakage: 1c.c./min. max. 4psi
- 0.250" quick disconnect terminals
- Size: 1.2"L x 0.92"Dia
- Weight: 0.1 lbs.

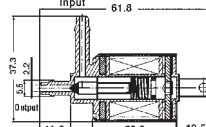

Part No.	Description	1	10	100
169834CD	Solenoid valve	\$6.95	\$6.25	\$5.59

120VAC Gear Motor

6.0 RPM - 2.9 Watt

- Operating Voltage: 120VAC @ 60Hz
- Torque: >3.6 kg-cm
- Connector: 12" wires
- Screw down tabs for mounting (2.3" diagonal mounting hole space)
- Shaft diameter: 0.27" • Shaft length: 0.65"
- Typical applications: air conditioner turnleaf motor, microwave turnplate motor
- Overall size: 2.0" Dia. x 1.0" Thick



Part No.	Prod. No.	Description	1	10	100
213487CD	50TYZ	Gear motor	\$19.95	\$17.95	\$16.25



24VDC Tubular Pull Solenoid

- Holding force: 4.0 lbs. @ 20°C
- Typical coil resistance: 60Ω
- 1" stroke
- Power: 10 watts
- 9" lead wires
- Size: 3.0"L x 1.0" Dia. • Weight: 0.4 lbs.



Part No.	Description	1	10	100
215141CD	24VDC pull solenoid	\$9.95	\$8.95	\$7.95

30-Day Money-Back Guarantee

If you're not satisfied we'll take it back!



Call for pricing on quantities over 100 – we carry major manufacturers. We will special order any IC – 100 Piece Minimum

EPROM

Part No.	Cross Ref.	Pins	Description	Dual-In-Line		
				1	10	100
39909CD	2708	24	1k x 8 8kB 450ns (±5V, +12V)	\$4.95	\$4.25	\$3.19
40002CD	2716	24	2k x 8 16kB 450ns (25V)	3.99	3.59	3.19
40011CD	2716-1	24	2k x 8 16kB 350ns (25V)	6.49	5.89	5.39
39706CD	27C16	24	2k x 8 16kB 450ns (25V) CMOS	7.25	6.55	5.99
114876CD	2732B	24	4k x 8 32kB 450ns (12.5V)	4.15	3.75	3.39
33591CD	TMS2532A	24	4k x 8 32kB 450ns (21V)	3.95	3.55	3.19
40096CD	2732	24	4k x 8 32kB 450ns (25V)	6.49	5.49	4.10
40109CD	2732A-20	24	4k x 8 32kB 200ns (21V)	6.49	5.99	5.49
40125CD	2732A-25	24	4k x 8 32kB 250ns (21V)	4.99	4.49	3.99
40133CD	2732A-45	24	4k x 8 32kB 450ns (21V)	3.99	3.69	3.29
39765CD	27C32	24	4k x 8 32kB 450ns (25V) CMOS	5.49	4.15	2.89
40192CD	2764-20	28	8k x 8 64kB 200ns (21V)	5.25	4.49	3.35
40205CD	2764-25	28	8k x 8 64kB 250ns (21V)	5.25	4.75	4.25
40230CD	2764A-20	28	8k x 8 64kB 200ns (12.5V)	4.49	4.05	3.65
40248CD	2764A-25	28	8k x 8 64kB 250ns (12.5V)	3.49	3.15	2.85
105304CD	27C64-12	28	8k x 8 64kB 120ns (12.5V) CMOS	6.49	5.99	5.49
39829CD	27C64-15	28	8k x 8 64kB 150ns (12.5V) CMOS	5.49	4.99	4.49
74608CD	27C64-20	28	8k x 8 64kB 200ns (12.5V) CMOS	4.69	4.29	3.79
39845CD	27C64-25	28	8k x 8 64kB 250ns (12.5V) CMOS	4.49	4.09	3.79
39933CD	27128-25	28	16k x 8 128kB 250ns (21V)	5.95	5.09	3.85
39950CD	27128A-15	28	16k x 8 128kB 150ns (12.5V)	4.49	3.95	3.55
39968CD	27128A-20	28	16k x 8 128kB 200ns (12.5V)	4.69	4.19	3.79
39984CD	27128A-25	28	16k x 8 128kB 250ns (12.5V)	4.49	4.05	3.69
87935CD	27C128-12	28	16k x 8 128kB 120ns (12.5V) CMOS	4.49	3.99	3.59
39677CD	27C128-15	28	16k x 8 128kB 150ns (12.5V) CMOS	4.29	3.85	3.45
101101CD	27C128-20	28	16k x 8 128kB 200ns (12.5V) CMOS	3.99	3.69	3.29
39685CD	27C128-25	28	16k x 8 128kB 250ns (12.5V) CMOS	3.99	3.59	3.25
40037CD	27256-15	28	32k x 8 256kB 150ns (12.5V)	3.25	3.09	2.75
40045CD	27256-20	28	32k x 8 256kB 200ns (12.5V)	3.15	3.05	2.75
40061CD	27256-25	28	32k x 8 256kB 250ns (12.5V)	3.15	2.95	2.65
140476CD	27C256-70	28	32k x 8 256kB 70ns (12.5V) CMOS	3.59	3.39	3.09
112740CD	27C256-10	28	32k x 8 256kB 100ns (12.5V) CMOS	3.35	3.15	2.85
65904CD	27C256-12	28	32k x 8 256kB 120ns (12.5V) CMOS	3.25	3.15	2.79
39714CD	27C256-15	28	32k x 8 256kB 150ns (12.5V) CMOS	3.25	3.09	2.75
39722CD	27C256-20	28	32k x 8 256kB 200ns (12.5V) CMOS	3.15	3.05	2.75
39731CD	27C256-25	28	32k x 8 256kB 250ns (12.5V) CMOS	3.15	2.95	2.65
40150CD	27512-20	28	64k x 8 512kB 200ns (12.5V)	2.75	2.45	2.25
40168CD	27512-25	28	64k x 8 512kB 250ns (12.5V)	2.55	2.35	2.14
203617CD	27C512-45	28	64k x 8 512kB 45ns (12.5V) CMOS	3.99	3.68	3.37
203625CD	27C512-70	28	64k x 8 512kB 70ns (12.5V) CMOS	3.69	3.49	3.15
175206CD	27C512-90	28	64k x 8 512kB 90ns (12.5V) CMOS	3.45	3.25	2.95
203730CD	27C512-10 PLCC	32	64k x 8 512kB 100ns (12.5V) CMOS	2.25	2.10	1.89
131959CD	27C512-10	28	64k x 8 512kB 100ns (12.5V) CMOS	3.39	3.15	2.85
39773CD	27C512-12	28	64k x 8 512kB 120ns (12.5V) CMOS	3.35	3.15	2.79
203692CD	27C512-12 OTP	28	64k x 8 512kB 120ns (12.5V) CMOS	2.25	1.89	1.79
39781CD	27C512-15	28	64k x 8 512kB 150ns (12.5V) CMOS	3.25	3.05	2.75
39790CD	27C512-20	28	64k x 8 512kB 200ns (12.5V) CMOS	3.15	2.95	2.65
39802CD	27C512-25	28	64k x 8 512kB 250ns (12.5V) CMOS	3.05	2.95	2.65
203633CD	27C1024-80	40	64k x 16 1024kB 80ns (12.5V) CMOS	4.99	4.49	3.99
203641CD	27C1024-12	40	64k x 16 1024kB 120ns (12.5V) CMOS	6.05	5.65	5.15
118148CD	27C1024-15	40	64k x 16 1024kB 150ns (12.5V) CMOS	5.95	5.55	4.99
137701CD	27C010-45	32	128k x 8 1024kB 45ns (12.5V) CMOS	6.09	5.49	4.99
146149CD	27C010-70	32	128k x 8 1024kB 70ns (12.5V) CMOS	5.55	5.15	4.69
137699CD	27C010-80	32	128k x 8 1024kB 80ns (12.5V) CMOS	5.12	4.61	4.09
203705CD	27C010-10 OTP	32	128k x 8 1024kB 100ns (12.5V) CMOS	2.55	2.35	2.15
203748CD	27C010-10 PLCC	32	128k x 8 1024kB 100ns (12.5V) CMOS	2.55	2.35	2.15
79231CD	27C010-10	32	128k x 8 1024kB 100ns (12.5V) CMOS	4.09	3.58	3.17
74624CD	27C010-12	32	128k x 8 1024kB 120ns (12.5V) CMOS	3.89	3.68	3.38
39651CD	27C010-15	32	128k x 8 1024kB 150ns (12.5V) CMOS	3.89	3.68	3.38
39669CD	27C010-20	32	128k x 8 1024kB 200ns (12.5V) CMOS	3.89	3.68	3.38
203650CD	27C020-80	32	256k x 8 2048kB 80ns (12.5V) CMOS	7.17	6.41	5.80
203713CD	27C020-10 OTP	32	256k x 8 2048kB 100ns (12.5V) CMOS	4.15	3.80	3.45
203756CD	27C020-10 PLCC	32	256k x 8 2048kB 100ns (12.5V) CMOS	3.99	3.75	3.49
156267CD	27C020-10	32	256k x 8 2048kB 100ns (12.5V) CMOS	5.63	5.22	4.71
78852CD	27C020-12	32	256k x 8 2048kB 120ns (12.5V) CMOS	5.63	5.22	4.71
65699CD	27C020-15	32	256k x 8 2048kB 150ns (12.5V) CMOS	5.63	5.22	4.71
65681CD	27C020-20	32	256k x 8 2048kB 200ns (12.5V) CMOS	5.63	5.22	4.71

EPROM (Continued)

Part No.	Cross Ref.	Pins	Description	Dual-In-Line		
				1	10	100
127933CD	27C4096-12	40	256k x 16 4096kB 120ns (12.5V) CMOS	\$9.22	\$8.60	\$7.85
203676CD	27C040-80	32	512k x 8 4096kB 80ns (12.5V) CMOS	12.29	11.27	10.24
203764CD	27C040-10 PLCC	32	512k x 8 4096kB 100ns (12.5V) CMOS	5.99	5.59	5.20
111780CD	27C040-10	32	512k x 8 4096kB 100ns (12.5V) CMOS	6.92	6.41	5.90
203721CD	27C040-12 OTP	32	512k x 8 4096kB 120ns (12.5V) CMOS	6.75	6.40	5.85
102293CD	27C040-12	32	512k x 8 4096kB 120ns (12.5V) CMOS	6.92	6.41	5.90
85462CD	27C040-15	32	512k x 8 4096kB 150ns (12.5V) CMOS	6.92	6.41	5.90
203668CD	27C040-45	32	512k x 8 4096kB 45ns (12.5V) CMOS	12.99	11.99	10.99
203684CD	27C080-90	32	1M x 8 8192kB 90ns (12.5V) CMOS	12.91	11.99	10.96
156275CD	27C080-10	32	1M x 8 8192kB 100ns (12.5V) CMOS	12.91	11.99	10.96
140003CD	27C080-12	32	1M x 8 8192kB 120ns (12.5V) CMOS	12.91	11.99	10.96
156283CD	27C160-10	42	2M x 8 16384kB 100ns (12.5V) CMOS	20.45	18.95	17.31

See EPROM programmers and erasers on page 116

EPROM Accessories

Part No.	Cross Ref.	Description	1	10
206922CD	EPTD	1.1" x 0.46" EPROM & DIP window labels UV opaque, accepts ink or pencil (168 labels per pack)	\$6.95	\$5.95
13864CD	CF2	Conductive foam (12" x 24" x .25") hard black	7.95	6.95
66042CD	DE1	UVP portable EPROM eraser, pg 116	64.95	58.95
15712CD	DE4	8-chip UV-EPROM eraser, pg 116	109.95	104.95

EEPROM

Part No.	Cross Ref.	Pins	Description	Dual-In-Line		
				1	10	100
108839CD	24C02P	8	256 x 8 2048-bit serial (CMOS)	\$0.79	\$0.69	\$0.62
108847CD	24C04P	8	512 x 8 4096-bit serial (CMOS)89	.79	.69
200547CD	24C08-10	8	1k x 8 1024-bit serial (CMOS)99	.89	.80
200555CD	24C16-10	8	2k x 8 16k serial (CMOS)	1.19	1.09	.95
200563CD	24C32-10	8	4k x 8 32k serial (CMOS)	1.75	1.69	1.45
200627CD	24C44	8	16 x 16 256-bit serial (CMOS)	2.49	1.79	1.55
200619CD	24C65	8	8k x 8 64k serial (CMOS)	1.89	1.69	1.49
200571CD	24C128-10	8	16k x 8 128k serial (CMOS)	3.75	3.10	2.79
200580CD	24C256-10	8	32k x 8 256k serial (CMOS)	3.59	2.35	2.15
74691CD	28C16A-25	24	2k x 8 16k 250ns (5V) CMOS	3.99	3.69	3.39
40416CD	2817A-25	28	2k x 8 16k 250ns 5V read/write	7.95	7.15	6.49
74827CD	28C64A-25	28	8k x 8 64k 250ns (5V) CMOS	4.49	4.05	3.65
40475CD	2865A	28	8k x 8 64k 250ns 5V read/write	4.95	4.49	4.05
74843CD	28C256-15	28	32k x 8 256k 150ns CMOS	8.95	6.95	6.25
74878CD	28C256-25	28	32k x 8 256k 250ns CMOS	8.75	6.85	6.05
102058CD	93C46	8	64 x 16 1024-bit serial (5V)59	.49	.45
108855CD	93C56	8	128 x 16 2048-bit serial (5V)69	.59	.49
200598CD	93C66	8	256 x 16 4096-bit serial (5V)69	.62	.55
200601CD	93C86	8	1k x 16 16k serial (5V)	1.39	1.25	1.15

PROM

Part No.	Cross Ref.	Pins	Description	Dual-In-Line		
				1	10	100
48531CD	74S188	16	32 x 8 Open collector (27S18)	\$4.95	\$4.25	\$3.19
48696CD	74S287	16	256 x 4 Tri-state (TBP24S10N)	6.95	6.25	5.65
48717CD	74S288	16	32 x 8 Tri-state (27S19/TBP18S030N)	2.99	2.55	1.95
48910CD	74S571	16	512 x 4 Tri-state (27S13)	5.99	5.69	5.39
48928CD	74S573	18	1024 x 4 Tri-state (27S33)	3.05	2.73	2.46
27844CD	N82S23	16	32 x 8 256-bit PROM (OC) (27S18)	6.95	6.25	5.65
27748CD	N82S100	28	16 x 48 x 8 Field-prog. logic array, tri-state	14.95	12.75	9.55
27764CD	N82S123	16	32 x 8 256-bit PROM tri-state (27S19)	5.95	5.35	4.85
27772CD	N82S126	16	256 x 4 1024-bit PROM (OC) (27S20)	10.95	10.39	9.85
27781CD	N82S129	16	256 x 4 1024-bit PROM tri-state (27S21)	7.95	6.95	6.25
27799CD	N82S131	16	512 x 4 2048-bit PROM tri-state (27S13)	7.99	6.99	5.99
27701CD	N82S137	18	1024 x 4 4096-bit PROM tri-state (27S33)	4.95</		

Call for pricing on quantities over 100 – we carry major manufacturers. We will special order any IC – 100 Piece Minimum

Dynamic and Video RAM

Part No.	Cross Ref.	Pins	Description	Dual-In-Line 		
				1	10	100
41339CD	4116-15	16	16k x 1 150ns (MM5290J-1R)	\$.99	\$.89	\$.80
191370CD	HM4816-4	16	16k x 1 120ns59	.55	.49
41662CD	4164-150	16	64k x 1 150ns (MCM6665-15)59	.53	.48
41398CD	41256-120	16	256k x 1 120ns (MB81256-12)73	.65	.59
41427CD	41256-150	16	256k x 1 150ns (P21256-15)69	.59	.49
41574CD	41464-10	18	64k x 4 100ns (HY53C464S-10)	1.69	1.65	1.59
42219CD	511000P-10	18	1M x 1 100ns (M5M4C1000-10)	2.25	1.99	1.79
93374CD	514256P-70	20	256k x 4 70ns (TC514256P-70)	2.79	2.49	2.19
42315CD	514256P-80	20	256k x 4 80ns (UPD424256-80)	2.49	2.25	2.05
128688CD	HM514260	SOJ	256k x 16 70ns	3.39	2.99	2.69

Static RAM

Part No.	Cross Ref.	Pins	Description	Dual-In-Line 		
				1	10	100
114260CD	DS1220Y-150	24	— 16k nonvol., 4.25V WP	\$11.95	\$10.95	\$9.85
114278CD	DS1225AB-150	28	— 64k nonvol., 4.62V WP	17.29	14.49	9.89
114286CD	DS1225AD-150	28	— 64k nonvol., 4.37V WP	11.95	10.95	9.85
114307CD	DS1225Y-200	28	— 64k nonvol., 4.25V WP	15.95	14.49	11.65
177113CD	DS1230Y-100	28	— 256k nonvol., 4.37V WP	21.95	18.69	13.99
114323CD	DS1230Y-150	28	— 256k nonvol., 4.37V WP	19.95	18.95	15.15
38738CD	2016-12	24	2k x 8 120ns (AM9128-12)	1.49	1.29	1.22
38746CD	2016-20	24	2k x 8 200ns (MB8128-20)	1.39	1.19	.89
38931CD	2111-1	18	256 x 4 500ns (AM9111APC)	1.95	1.75	1.59
38957CD	2114N	18	1k x 4 450ns (9114BPC)	2.25	1.99	1.79
38973CD	2114N-2	18	1k x 4 200ns (9114EPC) (U214D20)	2.49	2.25	2.05
38981CD	2114N-2L	18	1k x 4 200ns low power	2.49	2.25	2.05
25911CD	MK48Z02B-15	24	2k x 8 150ns (16k) zero-power RAM	9.99	8.99	7.99
42198CD	5101	22	256 x 4 450ns (CMOS)	7.99	7.19	6.49
42788CD	6116P-1	24	2k x 8 100ns (16kB) CMOS	1.69	1.55	1.39
42796CD	6116P-2	24	2k x 8 120ns (16kB) CMOS	1.59	1.35	1.05
42809CD	6116P-3	24	2k x 8 150ns (16kB) CMOS	1.49	1.29	1.15
42737CD	6116LP-1	24	2k x 8 100ns (16kB) LP CMOS	2.39	2.05	1.55
42753CD	6116LP-3	24	2k x 8 150ns (16kB) LP CMOS	1.95	1.69	1.25
42921CD	6264P-10	28	8k x 8 100ns (64kB) CMOS	2.59	2.29	1.99
42930CD	6264P-12	28	8k x 8 120ns (64kB) CMOS	2.65	2.39	2.15
85121CD	6264LP-70	28	8k x 8 70ns (64kB) LP CMOS	3.39	2.99	2.69
42884CD	6264LP-10	28	8k x 8 100ns (64kB) LP CMOS	2.75	2.49	2.25
42892CD	6264LP-12	28	8k x 8 120ns (64kB) LP CMOS	2.79	2.49	2.19
43238CD	6514	18	1k x 4 350ns CMOS (M58981P)	2.95	2.75	2.49
41970CD	43256-10L	28	32k x 8 100ns low power (NEC)	5.49	4.95	4.45
41988CD	43256-12L	28	32k x 8 120ns low power (NEC)	4.95	4.49	4.09
82472CD	62256LP-70	28	32k x 8 70ns low power CMOS	5.49	4.99	4.49
42833CD	62256LP-10	28	32k x 8 100ns low power CMOS	4.35	3.95	3.55
42850CD	62256LP-12	28	32k x 8 120ns low power CMOS	3.85	3.49	3.15
75037CD	ATT7C199P-15	28	32k x 8 15ns high speed CMOS (.3"W)	3.39	2.99	2.69
131810CD	628128LP-70	32	128k x 8 70ns low power CMOS	8.95	7.79	6.99
103982CD	628128LP-85	32	128k x 8 85ns low power CMOS	8.49	7.49	6.75
157358CD	628512LP-70	32	512k x 8 70ns low power CMOS	19.99	17.99	16.19

Voice Chips

Part No.	Product No.	Description	Dual-In-Line 		
			1	10	50
141671CD	ISD1110P	Voice record/playback (10 sec.)	\$4.29	\$3.99	\$3.79
107334CD	ISD1420P	Voice record/playback (20 sec.)	5.39	5.09	4.89
120643CD	ISD2560	Voice record/playback (60 sec.)	8.99	8.49	7.99
120660CD	ISD2590	Voice record/playback (90 sec.)	8.99	8.49	7.99
141655CD	ISD25120P	Voice record/playback (120 sec.)	8.99	8.49	7.99

Single-Chip Voice Record/Playback Devices

10 to 240 Second Durations (28-pin DIP)

- Easy-to-use single-chip voice recording and playback
- Manual switch or microprocessor controllable
- Directly cascadable for longer durations
- Fully addressable to handle multiple messages
- Zero-power message storage – eliminates battery backup circuits
- Single voltage operation: +5V (4.5V to 5.5V operating range)
- Automatic power-down (push-button mode)
- Playback can be edge or level-activated
- 1 µA standby current (typical)
- 100-year message retention (typical)
- On-chip clock source
- 100k record cycles (typical)
- On-chip automatic gain control (AGC)



CPUs/MPUs

Part No.	Description	MHz	Socket			
				1	10	25
188912CD	Pentium® III processor	733	Socket 370 ..	\$112.95	\$101.95	\$90.95
183118CD	Pentium® III processor	600	Slot 1	159.95	153.79	147.49
183100CD	Pentium® II processor	400	Slot 1	124.99	109.99	99.99
151651CD	Pentium® II processor	300	Slot 1	109.99	99.99	89.99
190060CD	Pentium® II processor w/ heat sink	233	Slot 1	89.95	79.95	72.95
150501CD	Pentium MMX® processor	233	376/PGA	69.95	62.95	54.95
140054CD	Pentium MMX® processor	200	376/PGA	49.95	42.49	31.85
196912CD	Pentium MMX® processor	166	296/PGA	29.95	29.95	29.95
189296CD	Pentium® processor	200	296/PGA	69.95	52.49	36.75
130841CD	Pentium® processor	166	296/PGA	54.99	46.75	35.09
130833CD	Pentium® processor	133	296/PGA	29.95	26.95	24.25
189253CD	Athlon®, A0900AMT3B	900	Slot A	69.95	69.95	69.95
192751CD	Athlon®, A0750MPR24B	750	Slot A	64.95	64.95	64.95
189270CD	486DX4 (Intel), FC80486DX4	75	208/SQFP	9.69	8.85	8.15
118421CD	486 speed doubler (Intel), 80486DX2	66	168/PGA	19.95	17.95	16.15
135571CD	486 speed doubler (SGS), ST486DX2	66	168/PGA	10.35	9.39	8.55

Math Coprocessor

Part No.	Cross Ref.	Pins	Description			
				1	10	25
76531CD	80387-25SX 68PLCC	25MHz math coprocessors	\$27.95	\$24.95	\$22.45	

V20 Chip

Part No.	Cross Ref.	Pins	MHz	Description	Dual-In-Line 		
					1	10	100
34358CD	UPD70108-8	40	8	V20 chip (replaces the 8088-2)	\$10.99	\$9.99	\$8.99

Z80 Series

Part No.	Cross Ref.	Pins	MHz	Description	Dual-In-Line 		
					1	10	100
35561CD	Z80	40	2.5	CPU (MK3880N/780C)	\$1.39	\$1.19	\$1.09
35596CD	Z80A	40	4	CPU (MK3880N-4/780C-1)	1.99	1.79	1.59
35609CD	Z80A-CTC	28	4	Counter timer circuit (MK3882-4)	2.19	1.99	1.79
35625CD	Z80A-DART	40	4	Dual asynchronous receiver/transmitter	3.49	3.19	2.89
35641CD	Z80A-PIO	40	4	Parallel I/O interf. contr. (MK3881-4)	1.49	1.29	.95
35668CD	Z80A-SIO/0	40	4	Serial I/O (TxCB & RxCB bond.) MK3884-4	2.19	1.95	1.75
35705CD	Z80B	40	6	CPU (MK3880N-6)	2.59	2.35	2.09
35781CD	Z84C00-4	40	4	CPU (Z84C004PEC) CMOS	4.75	3.63	2.59
35799CD	Z8530	40	2	Serial communications controller	2.49	2.15	1.59
185332CD	Z8681	40	2	ROMless MCU55	.50	.45

UARTs

Part No.	Cross Ref.	Pins	Description	Dual-In-Line 		
				1	10	100
43158CD	6402	40	CMOS/LSI UART (TR1863)	\$4.95	\$4.49	\$4.05
27570CD	NS16C450N	40	CMOS ACE (IBM-AT compat.) (82C450)	5.95	5.39	4.85
27596CD	NS16550AN	40	Univ. asynch. rcvr./trans. w/ FIFO (PC16550DN)	5.95	5.09	3.79

6500 Series/Commodore

Part No.	Cross Ref.	Pins	Description	Dual-In-Line 		
				1	10	100
43191CD	6502	40	MPU with internal clock (1MHz)	\$7.95	\$6.95	\$6.25
43166CD	65C02	40	MPU with internal clock (CMOS)	6.95	5.25	3.65
43254CD	6522	40	VIA (versatile interface adapter) 1MHz	2.39	2.15	1.94
43318CD	6551	28	ACIA (asynch. comm. interface adptr)	3.95	3.49	3.15

IC Test Clip Series

Part No.	Cross Ref.	Description			
			1	10	25
22103CD	JTC16	16-pin (for 8, 14 and 16-pin ICs)	\$6.95	\$6.25	\$5.59
22120CD	JTC20	20-pin (for 18 and 20-pin ICs)	8.95	6.50	5.35
22162CD	JTC28	28-pin	10.95	9.95	8.95
22189CD	JTC40	40-pin	11.95	11.35	10.75



See page 171 for CPU Heat Sinks and Fans



Call for pricing on quantities over 100 – we carry major manufacturers. We will special order any IC – 100 Piece Minimum

6800/68000 Series

Part No.	Cross Ref.	Pins	Description	Dual-In-Line		
				1	10	100
43481CD	6800	40	8-bit MCU	\$6.95	\$5.25	\$3.65
43502CD	6802	40	8-bit MPU with clock and RAM (1MHz)	8.69	7.82	6.99
43529CD	6803	40	8-bit MCU with 128k RAM	7.79	6.99	6.29
43537CD	MC6808	40	8-bit MPU with clock and 128k RAM	9.95	6.69	6.75
43545CD	6809E	40	MPU with external clock (1MHz)	3.95	3.59	3.25
43561CD	6810	24	128x8 static RAM (1MHz)	1.49	1.35	1.19
43596CD	6821	40	Peripheral interface adapter (1MHz)	3.95	3.59	3.25
43414CD	68B21	40	Peripheral interface adapter (2MHz)	4.95	4.49	4.05
43617CD	6840	28	Programmable timer (1MHz)	2.49	2.25	1.99
43633CD	6850	24	Asynch. comm. int. adapter (ACIA)	2.39	2.09	1.89
25304CD	MC68000L8	64	MPU 16-bit (8MHz)	8.95	7.95	7.25
25291CD	MC68000L10	64	MPU 16-bit (10MHz)	14.95	12.75	9.55
25355CD	MC68701	40	8-bit EPROM MPU w/ 128B RAM & I/O	15.95	13.95	12.55
25363CD	MC68705P3S	28	8-bit EPROM MPU w/ 112B RAM & I/O	24.95	22.95	20.65
25371CD	MC68705U3S	40	8-bit EPROM MPU w/ 112B RAM & I/O	29.95	25.49	19.09
191863CD	MC68HC11E1CP2	48	8-bit micro cntl. w/ A/D conv. (512B RAM)	15.95	13.95	12.55
108919CD	MC68HC705C8P	40	8-bit HCMOS MCU, 8k OTPROM, 24 I/O lines	9.95	8.95	8.05
132484CD	MC68HC705C8S	40	8-bit HCMOS MCU, 8k bytes, EPROM	38.95	34.95	31.55
108927CD	MC68HC705K1P	16	8-bit HCMOS MCU, 504B, OTPROM, 10 I/O tmr	7.95	7.15	6.45

8000 Series

Part No.	Cross Ref.	Pins	Description	Dual-In-Line		
				1	10	100
51844CD	8031	40	CPU with 128 x 8 RAM and I/O	\$3.29	\$2.99	\$2.69
51676CD	80C31	40	CPU with 128 x 8 RAM and I/O (CMOS)	3.39	2.89	2.19
102197CD	8032	40	8-bit MCU 256 x 8 RAM	3.95	3.59	3.25
108804CD	80C32-1	40	8-bit MCU 256 x 8 RAM (CMOS)	4.49	3.99	3.59
51861CD	8035	40	MPU 8-bit	3.95	3.59	3.25
51959CD	8039	40	CPU single chip 8-bit (128 bytes RAM)	4.49	3.99	3.59
51692CD	80C39	40	CPU single chip 8-bit (128 bytes RAM) CMOS	3.99	3.59	3.25
51983CD	8049*	40	CPU single chip 8-bit (can be used as 8039*)	1.95	1.75	1.59
51991CD	8051AP**	40	MCU w/128x8 RAM (book 161402CD, pg 214)	5.49	4.99	4.49
52003CD	8052AH**	40	CPU 8-bit 256 bytes RAM, timer/counter & I/O	7.99	7.19	6.49
125647CD	80C52BASIC	40	CPU 8-bit CMOS with basic interpreter	19.95	17.95	16.89
52046CD	8080A	40	CPU 8-bit N-channel (1MHz)	4.49	3.95	3.59
52062CD	8085A	40	CPU 8-bit N-channel (3MHz)	4.99	4.25	3.19
52071CD	8085A-2	40	CPU 8-bit N-channel (5MHz)	5.49	4.99	4.49
51705CD	80C85	40	CPU 8-bit N-channel (3MHz)(CMOS)	6.95	5.95	4.45
52100CD	8086-2	40	CPU 16-bit (8MHz)	1.95	1.75	1.59
52142CD	8088	40	CPU 16-bit (8-bit data bus) 5MHz	2.49	2.25	1.99
52169CD	8088-2	40	CPU 16-bit (8-bit data bus) 8MHz	5.95	5.39	4.85
52290CD	8155	40	HMOS RAM I/O port/timer (3MHz)	4.49	3.99	3.59
52302CD	8155-2	40	HMOS RAM I/O port/timer (5MHz)	5.95	5.39	4.85
52193CD	81C55	40	256x8 RAM I/O port/timer (CMOS) 3MHz	3.95	3.59	3.19
52329CD	8156	40	RAM with I/O port and timer	9.95	8.49	6.35
52468CD	8212	24	8-bit input/output (74S412)	6.49	5.99	5.49
52484CD	8216	16	Bi-directional bus driver (non-invert.)	3.95	3.39	2.55
52492CD	8224	16	Clock generator/driver	2.95	2.49	2.25
52513CD	8228	28	System contr./bus driver (74S428)	2.95	2.55	1.89
52581CD	8243	24	I/O expander for 48 series	5.49	4.99	4.49
52610CD	8250A	40	Asynchronous comm. element	4.95	4.25	3.19
52644CD	8251	28	Prog. comm. I/O (USART)	2.99	2.69	2.39
52652CD	8251A	28	Prog. comm. interface (USART)	3.99	3.69	3.39
52370CD	82C51A	28	Prog. comm. interface (USART) CMOS	4.49	3.99	3.49
52679CD	8253	24	Prog. interval timer	3.19	2.89	2.59
52687CD	8253-5	24	Prog. interval timer (2MHz)	4.99	4.49	3.99
52388CD	82C53-5	24	Prog. interval timer (CMOS) 2MHz	4.95	4.25	3.19
52708CD	8254	24	Prog. interval timer (UPD71054)	4.49	3.99	3.59
52716CD	8254-2	24	Prog. interval timer (10MHz)	7.35	6.65	5.95
52396CD	82C54	24	Prog. interval timer (CMOS)	3.95	3.39	2.55
52409CD	82C54-2	24	Prog. interval timer (CMOS) 10MHz	4.49	3.85	2.89
52724CD	8255	40	Prog. peripheral I/O (PPI) 71055 (2MHz)	4.49	3.99	3.49
52732CD	8255A-5	40	Prog. peripheral I/O (PPI) 5MHz	5.49 4.89	4.39	2.89
52417CD	82C55A	40	Prog. peripheral I/O (PPI) CMOS	4.99	4.49	3.99
52425CD	82C55A-5	40	Prog. peripheral I/O (PPI) CMOS (5MHz)	4.49	3.99	3.49
5259CD	8256	40	Multif. universal asynch. rec./trans.	19.99	17.99	16.19

* 8049 (ROM not available for use) Tie pin 7 high to bypass the internal ROM to convert 8049 to 8039
 ** Tie pin 31 low to bypass the internal ROM

8000 Series (Continued)

Part No.	Cross Ref.	Pins	Description	Dual-In-Line		
				1	10	100
52775CD	8259	28	Prog. interrupt controller (UPD71059)	\$1.75	\$1.55	\$1.45
52783CD	8259-5	28	Prog. interrupt controller (8259A-2)	2.49	2.19	1.99
52821CD	8275	40	Prog. CRT controller	12.95	11.05	8.29
52839CD	8279	40	Prog. keyboard/display interface	12.99	11.99	10.99
52847CD	8279-5	40	Prog. keyboard/display interface (5MHz)	12.95	11.69	10.49
52855CD	8282	20	Octal latch (UPD71082)	6.49	5.55	4.15
52871CD	8284A	18	Clock gen. and driver (UPD71084)	4.49	3.99	3.59
52898CD	8286	20	Octal bus transceiver (UPD71086)	3.95	3.59	3.25
52901CD	8287	20	Octal bus transceiver (inverted)	10.99	9.99	8.99
52919CD	8288	20	Bus controller (UPD71088) 82C88-2	1.95	1.65	1.25
53006CD	8741	40	8-bit univ. peripheral interface (EPROM)	7.99	7.19	6.49
53014CD	8742	40	8-bit univ. peripheral interface	9.95	8.49	6.35
53022CD	8748	40	CPU 8-bit, EPROM, RAM and I/O (21V)	13.95	11.89	8.89
53031CD	8748H	40	CPU 8-bit, EPROM, RAM & I/O HMOS (21V)	15.95	14.49	12.99
53057CD	8749H	40	MPU 8-bit (EPROM version 8049)	22.99	19.99	17.95
53073CD	8751	40	CPU w/ 4kx8 EPROM & 128x8 RAM (3.5-8MHz)	19.99	17.99	16.19
53081CD	8751H	40	CPU w/ 4kx8 EPROM & 128x8 RAM (1.2-12MHz) 28.49	24.25	21.25	18.19
52978CD	87C51	40	CPU w/ 4kx8 EPROM & 128x8 RAM(3.5-12MHz)	21.99	18.69	13.99
196120CD	P87C51	40	CPU w/ 4kx8 EPROM & 128x8 RAM(3.5-12MHz)OTP	12.95	11.95	10.75
53090CD	8755	40	16k EPROM with I/O	8.95	8.09	7.29

CMOS PIC Microcontrollers

Part No.	Product No.	Pins	Conf.	Speed (MHz)	EPROM Bits	RAM Bytes	I/O Lines	Dual-In-Line		
								1	10	100
145040CD	PIC12C508-04/P	8	OTP	4	512 x 12	25	5	1.75	1.49	1.25
145058CD	PIC12C509/JW	8	EPROM	4	1k x 12	41	5	13.95	12.59	11.59
144258CD	PIC12C509-04/P	8	OTP	4	1k x 12	41	5	1.95	1.55	1.29
200475CD	PIC12CE518-04/P	8	OTP	4	512 x 12	25	6	1.79	1.59	1.49
193455CD	PIC12C671-04/P	8	OTP	4	1k x 14	128	6	2.69	2.55	2.45
193463CD	PIC12C672-04/P	8	OTP	4	2k x 14	128	6	2.89	2.65	2.45
223790CD	PIC12F629-I/P	8	Flash	20	1k x 14	64	6	1.89	1.59	1.40
223781CD	PIC12F675-I/P	8	Flash	20	1k x 14	64	6	2.35	1.99	1.79
200459CD	PIC16C505-04/P	14	OTP	20	1k x 12	72	12	1.95	1.75	1.65
128338CD	PIC16C54A-04/P	18	OTP	4	512 x 12	25	12	3.29	2.69	2.49
200416CD	PIC16C55A-04/P	28	OTP	4	512 x 12	24	20	2.69	2.49	2.29
134172CD	PIC16C56-RC/P	18	OTP	20	1k x 12	25	12	3.75	3.49	3.25
213495CD	PIC16C57C/JW	28	EPROM	40	2k x 12	72	20	13.95	12.95	11.95
193341CD	PIC16C57C-04/P	28	OTP	4	2k x 12	72	20	3.19	2.89	2.69
193383CD	PIC16C622A-04/P	18	OTP	4	2k x 14	128	13	3.09	2.78	2.50
193439CD	PIC16F627-20/P	18	Flash	20	1k x 14	224	16	3.39	3.05	2.74
193447CD	PIC16F628-20/P	18	Flash	20	2k x 14	224	16	3.49	3.15	2.89
223749CD	PIC16F630-I/P	14	Flash	20	1k x 14	64	12	2.19	1.89	1.65
223757CD	PIC16F676-I/P	14	Flash	20	1k x 14	64	12	2.55	2.19	1.90
193324CD	PIC16C63A-20/SP	28	OTP	20	4k x 14	192	22	5.39	4.99	4.79
193359CD	PIC16C711-04/P	18	OTP	4	1k x 14	68	13	3.59	2.19	1.99
200432CD	PIC16C72A-04/P	28	OTP	4	2k x 14	128	22	4.99	4.49	4.39
193391CD	PIC16F73-I/SP	28	Flash	20	4k x 13	192	5	4.99	4.49	4.29
145091CD	PIC16C74A/JW	40	EPROM	20	14k x 14	192	33	19.95	18.99	17.99
193404CD	PIC16F74-I/P	40	Flash	20	4k x 14	192	8	6.49	5.84	5.25
193412CD	PIC16F76-I/P	28	Flash	20	8k x 14	368	5	7.29	6.89	6.49
193421CD	PIC16F77-I/P	40	Flash	20	8k x 14	368	8	8.19	7.37	6.63
223765CD	PIC16F818-I/P	18	Flash	20	1k x 14	128	16	3.24	2.79	2.45
223773CD	PIC16F819-I/P	18	Flash	20	2k x 14	256	16	3.69	3.15	2.75
145111CD	PIC16F84-04/P	18	Flash	4	1k x 14	68	13	5.95	5.35	4.75
145120CD	PIC16F84-10/P	18	Flash	10	1k x 14	68	13	6.85	6.51	6.19
193332CD	PIC16F84A-20/P	18	Flash	20	1k x 14	68	13	5.95	5.35	5.09
193367CD	PIC16F876-20/SP	28	Flash	20	256 x 8	368	22	8.39	7.59	7.15
176882CD	PIC16F877-20/P	40	Flash	20	256 x 8	368	33	9.49	8.49	7.49
200504CD	PIC18C252-I/P	28	OTP	40	32k x 16	1536	23	8.20	7.28	6.55
200512CD	PIC18C452-I/P	40	OTP	40	32k x 16	1536	23	9.10	8.09	7.25
200521CD	PIC18C452/JW	40	EPROM	40	32k x 16	1536	23	21.95	20.85	20.75

Call us with your 100 piece minimum order

We'll Find Any IC!

1-800-831-4242

Call for pricing on quantities over 100 – we carry major manufacturers. We will special order any IC – 100 Piece Minimum

AT89C Series

		Dual-In-Line		
Part No.	Product No.	Pins	Description	1 10 100
168866CD	AT89C1051-24PC	20	8-bit MCU, 24MHz 1kb flash memory	\$3.39 \$2.14 \$1.95
168874CD	AT89C2051-24PC	20	8-bit MCU, 24MHz 2kb flash memory	3.59 2.39 2.15
204089CD	AT89C4051-24PC	20	8-bit MCU, 24MHz 4kb flash mem. 8-bit	4.49 2.95 2.65
168891CD	AT89C51-20PC	40	8-bit MCU, 20MHz 4kb flash memory	4.25 3.84 3.49
168903CD	AT89C51-24PC	40	8-bit MCU, 24MHz 4kb flash memory	4.49 3.99 3.59
168920CD	AT89C52-24PC	40	8-bit MCU, 24MHz 8kb flash memory	4.39 2.85 2.55
168938CD	AT89C52-24JC	44	8-bit MCU, 24MHz 8kb flash mem. PLCC	4.35 2.83 2.53
220871CD	AT89S52-24JI	44	8-bit MCU, 8kb programmable flash PLCC	4.35 2.83 2.53
168946CD	AT89C55WD-24PC	40	8-bit MCU, 24MHz 20kb flash memory	7.99 7.19 6.49
204097CD	AT89S8252-24PC	40	8-bit MCU, 24MHz 8kb flash mem. 2kb EEPROM	6.75 4.49 3.95
204100CD	AT90S1200-12PC	20	20 AVR 8-bit RISC MCU, 12MHz 1kb prog. flash	2.95 1.95 1.75
204126CD	AT90S8515-8PC	40	40 AVR 8-bit RISC MCU, 8MHz 8kb prog. flash	7.95 5.49 4.95

Microcontrollers

80C52-BASIC Microcontroller

The 80C52-BASIC chip is a custom-masked 80C52 microcontroller with a full-featured 8k-byte ROM-resident BASIC-52 interpreter.

Hardware: • On-chip oscillator and clock circuit

• Operates DC to 12MHz • 256 x 8-bit RAM

Software: • Full BASIC interpreter in ROM on a single chip

• "Stand-alone" software development

• Interrupts can be handled by BASIC or Assembly Language



Part No.	Product No.	Description	1	10	100
125647CD	80C52BASIC	CPU 8-bit CMOS w/ BASIC interpreter	\$19.95	\$17.95	\$16.89

50MIPS SX Microcontroller

Part No.	Parallax No.	Description	1	10
162931CD	SX28AC/DP	28-pin DIP package	\$5.49	\$5.25

PALs and GALs

		Dual-In-Line		
Part No.	Cross Ref.	Pins	Description	1 10 100
28020CD	PAL16L8	20	Octal 16-input AND-OR-INVERT gate array	\$2.25 \$1.75 \$1.66
88399CD	16V8-10*	20	10ns 64 x 32 AND array	2.59 2.35 2.10
37452CD	16V8-15*	20	15ns 64 x 32 AND array	1.39 1.25 1.12
37461CD	16V8-25*	20	25ns 64 x 32 AND array	1.25 1.09 .99
88292CD	20V8-10**	24	10ns 64 x 40 AND array	3.29 2.99 2.69
38658CD	20V8-15**	24	15ns 64 x 40 AND array	1.75 1.55 1.35
38666CD	20V8-25**	24	25ns 64 x 40 AND array	1.75 1.59 1.45
123801CD	22V10-10	24	10ns 132 x 44 AND array	5.49 4.99 4.49
39159CD	22V10-15	24	15ns 132 x 44 AND array	4.49 3.95 3.55
39167CD	22V10-25	24	25ns 132 x 44 AND array Lattice	3.99 3.49 3.09

GALs are electrically erasable PLDs that can be used in place of numerous PALs

* Replaces PALs: 10H8, 10L8, 10P8, 12H6, 12L6, 12P6, 14H4, 14L4, 14P4, 16H2, 16H8, 16L2, 16L8, 16P2, 16P8, 16R4, 16R6, 16R8, 16RP4, 16RP6, 16RP8

** Replaces PALs: 14H8, 14L8, 14P8, 16H6, 16L6, 16P6, 18H4, 18L4, 18P4, 20H2, 20H8, 20L2, 20L8, 20P2, 20P8, 20R4, 20R6, 20R8, 20RP4, 20RP6, 20RP8

Peel Devices (CMOS)

Programmable Electrically Erasable Logic (PEEL) devices allow for supersets replacement of over 40 standard 20-pin and 24-pin PLDs (PAL, GAL, EPLD, etc.). They also offer additional architectural features so more logic can be put into every design.

Part No.	Cross Ref.	Pins	Description	1	10	100
105953CD	18CV8P-25	20	PLD superset 12 config. I/O pins (8) 25ns	\$2.25	\$1.95	\$1.45
105996CD	22CV10AP-25	24	PLD superset 4/12 config. I/O pins (10) 25ns	2.59	2.19	1.65

4000 Series

		Dual-In-Line		
Part No.	Cross Ref.	Pins	Description	1 10 100
12562CD	CD4001**	14	Quad 2-input NOR gate	\$.29 \$.24 \$.21
12597CD	CD4007	14	Dual comp. pair with inverter	.29 .25 .22
12634CD	CD4011**	14	Quad 2-input NAND gate	.29 .24 .21
12677CD	CD4013**	14	Dual D flip-flop with set/reset	.39 .34 .25
12706CD	CD4015*	16	Dual 4-stage static shift register	.39 .35 .31
12722CD	CD4016*	14	Quad bilateral switch	.29 .25 .22
12749CD	CD4017*	16	Decade counter/divider	.39 .35 .31
12773CD	CD4018	16	Presetable divide-by-N counter	.49 .37 .26
12802CD	CD4020*	16	14-stage binary/ripple counter	.55 .49 .44
12829CD	CD4021	16	8-stage static shift register	.42 .35 .29

4000 Series (Continued)

		Dual-In-Line		
Part No.	Cross Ref.	Pins	Description	1 10 100
54666CD	CD4022	16	Div. by 8-cntr./driver w/ 8-decoded outputs	\$.59 \$.43 \$.37
12845CD	CD4023*	14	Triple 3-input NAND gate	.29 .25 .19
12853CD	CD4024*	14	7-stage binary counter	.39 .33 .25
12888CD	CD4027*	16	Dual JK master-slave flip-flop	.29 .24 .21
12909CD	CD4028	16	BCD-to-decimal decoder	.45 .32 .28
12925CD	CD4029	16	Presetable up/down counter	.48 .39 .29
12950CD	CD4040*	16	12-stage binary/ripple counter	.39 .35 .29
12984CD	CD4042	16	Quad clocked D latch	.49 .45 .35
12992CD	CD4043	16	Quad NOR R-S latch tri-state	.35 .29 .22
13004CD	CD4044	16	Quad 3-state NAND R-S latch tri-state	.49 .42 .31
13012CD	CD4046*	16	Micropower phase-locked loop	.49 .45 .39
13039CD	CD4047	14	Monostable/astable multivibrator	.48 .44 .42
13055CD	CD4049**	16	Hex/buffer/converter (inverting)	.29 .24 .21
13071CD	CD4050*	16	Hex/buffer/converter (N-inverting)	.29 .26 .23
13098CD	CD4051*	16	Single 8-channel multi./demultiplexer	.45 .39 .35
13119CD	CD4052	16	Diff. 4-channel multi./demultiplexer	.45 .39 .29
13127CD	CD4053	16	Triple 2-channel multi./demultiplexer	.45 .39 .35
13151CD	CD4060	16	14-stage ripple-carry binary	.49 .45 .39
13186CD	CD4066**	14	Quad bilateral switch	.35 .29 .25
13215CD	CD4067	24	16-channel analog multi./demultiplexer	1.29 1.09 .87
13231CD	CD4069*	14	Hex inverter (74C04)	.29 .26 .23
13258CD	CD4070*	14	Quad EXCLUSIVE-OR gate (74C86)	.29 .26 .23
13274CD	CD4071*	14	Quad 2-input OR gate	.29 .26 .23
13354CD	CD4081*	14	Quad 2-input AND gate	.25 .19 .17
13400CD	CD4093*	14	Quad 2-input NAND Schmitt trigger	.29 .25 .22
13426CD	CD4094	16	8-stage shift-and-store bus register	.49 .43 .37
13434CD	CD4098	16	CMOS/MOS dual mono. multivibrator	.39 .35 .29
13442CD	CD4099	16	8-bit addressable latch	.49 .35 .25
44257CD	CD40106	14	Hex inverter Schmitt trigger (74C14)	.39 .35 .31
13469CD	CD4503	16	Tri-state hex buffer (74C367) 80C97	.39 .34 .29
13485CD	CD4510	16	BCD up/down counter	.69 .59 .45
13493CD	CD4511*	16	BCD to 7-seg. latch/decoder/driver	.69 .59 .49
13514CD	CD4512	16	8-channel data selector	.59 .50 .38
13522CD	CD4514	24	4-bit latch/4-16 line decoder	.89 .79 .69
13549CD	CD4516	16	Binary up/down counter	.54 .46 .34
13565CD	CD4518	16	Dual BCD up counter	.49 .42 .31
13581CD	CD4520	16	Dual binary up counter	.49 .44 .39
13590CD	CD4522	16	Program. BCD divide-by-N counter	.89 .76 .57
13602CD	CD4526	16	Divide-by-N counter (binary)	.55 .47 .42
13611CD	CD4528	16	Dual monostable multivibrator	.69 .49 .39
13653CD	CD4538*	16	Dual precision monostable multivibrator	.59 .53 .48
13688CD	CD4541	14	Oscillator/programmable timer	.49 .45 .39
13696CD	CD4543*	16	BCD to 7-segment decoder (LCD)	.69 .59 .49
13709CD	CD4553	16	3-digit BCD counter	2.95 2.75 2.49
13768CD	CD4584*	14	Hex Schmitt trigger (74C14) 40106	.39 .35 .29

*10 pcs. in 4000 series IC cabinet kit, pg 110 **20 pcs. in 4000 series IC cabinet kit, pg 110

7400 Series

		Dual-In-Line		
Part No.	Cross Ref.	Pins	Description	1 10 100
48979CD	7400**	14	Quad 2-input NAND gate	\$.65 \$.55 \$.45
49007CD	7401	14	Quad 2-input NAND gate (O.C.)	.49 .45 .39
49015CD	7402*	14	Quad 2-input NOR gate	.59 .49 .45
49040CD	7404**	14	Hex inverter	.59 .49 .45
49074CD	7405*	14	Hex inverter (O.C.)	.49 .44 .39
49091CD	7406**	14	Hex inverter buffer/driver (O.C.)	.45 .39 .35
49120CD	7407**	14	Hex buffer/driver (O.C.)	.35 .32 .28
49146CD	7408*	14	Quad 2-input AND gate	.79 .55 .45
49189CD	7410*	14	Triple 3-input NAND gate	.29 .25 .18
49402CD	7413	14	Dual 4-input NAND gate Schmitt trigger	.89 .76 .57
49437CD	7414*	14	Hex inverter Schmitt trigger	.59 .49 .45
49630CD	7416*	14	Hex inverter buffer/driver (O.C.)	.69 .59 .44
49728CD	7417*	14	Hex buffer/driver (O.C. hi-voltage)	.79 .67 .50
50008CD	7420*	14	Dual 4-input NAND gate	.49 .45 .39
50083CD	7425	14	Dual 4-input NOR gate with strobe	.89 .79 .69
50139CD	7427	14	Triple 3-input NOR gate	.59 .50 .38
50198CD	7428	14	Quad 2-input NOR buffer	.29 .25 .22
50227CD	7430*	14	8-input NAND gate	.49 .42 .32
50235CD	7432*	14	Quad 2-input OR gate	.59 .49 .45

*10 pcs. in 7400 series IC cabinet kit, pg 110 **20 pcs. in 7400 series IC cabinet kit, pg 110



Call for pricing on quantities over 100 – we carry major manufacturers.

We will special order any IC – 100 Piece Minimum

ICs

7400 Series (Continued)

Part No.	Cross Ref.	Pins	Description	Dual-In-Line		
				1	10	100
50315CD	7438*	14	Quad 2-input NAND buffer (O.C.)	\$.49	\$.42	\$.32
50358CD	7440	14	Dual 4-input NAND buffer	.59	.53	.49
50374CD	7442	16	BCD-to-decimal decoder	.99	.84	.63
50403CD	7445	16	BCD-to-decimal decoder/driver (30V)	.89	.79	.69
50411CD	7446	16	BCD-to-7 segment decoder/driver (30V)	1.49	1.29	.99
50420CD	7447*	16	BCD-to-7 segment decoder/driver (15V)	1.49	1.29	.99
50518CD	7470*	14	Edge-triggered JK flip-flop	.89	.79	.72
50526CD	7472	14	AND gated JK master/slave flip-flop	.99	.84	.63
50534CD	7473	14	Dual JK flip-flop with clear	.99	.84	.63
50551CD	7474**	14	Dual D flip-flop	.59	.49	.39
50577CD	7475	16	4-bit bi-stable latch	2.95	2.75	2.49
50593CD	7476	16	Dual JK flip-flop with preset and clear	.89	.73	.59
50631CD	7483	16	4-bit binary full adder	.89	.79	.69
50657CD	7485*	16	4-bit magnitude comparator	.59	.49	.36
50665CD	7486	14	Quad EXCLUSIVE-OR gate	.89	.75	.56
50681CD	7489	16	64-bit RAM P 50ns	3.49	3.19	2.99
50690CD	7490	14	Decade counter	1.49	1.29	1.15
50737CD	7492	14	Divide-by-12 counter	1.49	1.29	.95
50745CD	7493	14	4-bit binary counter	1.49	1.34	1.19
50770CD	7495*	14	4-bit parallel-access shift register (K155N)	.69	.59	.39
50796CD	7497	16	Synch. 6-bit binary rate multipliers	1.59	1.35	.99
49234CD	74107*	14	Dual JK flip-flop with clear	.39	.33	.24
49293CD	74116	24	Dual 4-bit latches with clear	.99	.89	.79
49322CD	74121	14	Monostable multivibrator	.99	.89	.79
49349CD	74122	14	Retriggerable mono. multivibrator with clear	.89	.80	.72
49357CD	74123*	16	Dual retriggerable mono. multivibrator	.89	.75	.56
49373CD	74125	14	Quad bus buffer tri-state (DM8093N)	.89	.79	.69
49411CD	74132*	14	Quad 2-input NAND Schmitt trigger	.89	.79	.69
49496CD	74148	16	8 to 3 line octal priority encoder	.99	.89	.79
49509CD	74150	24	16 to 1 line multiplexer	1.95	1.75	1.55
49525CD	74151*	16	8-input multiplexer	.39	.35	.29
49550CD	74153*	16	Dual 4/1 data selector/multiplexer	.39	.34	.29
49568CD	74154	24	4 to 16 line decoder/demultiplexer	2.25	1.95	1.75
49605CD	74157*	16	Quad 2/1 data selector	.49	.42	.32
49648CD	74160*	16	Decade counter with asynch. clear	.39	.33	.25
49664CD	74161	16	Synchronous 4-bit counter	.49	.42	.32
49672CD	74163	16	Synchronous 4-bit counter	.49	.42	.31
49681CD	74164	14	8-bit serial shift register	.59	.50	.38
49699CD	74165	16	8-bit serial shift register, parallel load	.69	.59	.45
49779CD	74174*	16	Hex D-type flip-flop with clear	.69	.59	.45
49795CD	74175*	16	Quad D-type flip-flop with clear	.59	.50	.38
49832CD	74180	14	9-bit odd/even parity generator/checker	1.99	1.79	1.59
49841CD	74181	24	Arithmetic logic unit/function generator	2.29	1.99	1.79
49883CD	74189	16	64-bit RAM tri-state (DM8599N)	3.99	3.39	2.55
49904CD	74191	16	Binary up/down counter	1.29	1.15	.87
49912CD	74192	16	Decade up/down counter with clear	3.69	3.39	3.19
49939CD	74193	16	Binary up/down counter with clear	1.39	1.19	1.09
49955CD	74194	16	4-bit bi-directional shift register	1.39	1.25	1.15
49963CD	74195	16	4-bit parallel-access shift register	1.85	1.75	1.65
50171CD	74279*	16	Quad set-reset latch	1.39	1.25	1.15
88225CD	SDLL001A	—	Texas Instruments TTL Data Book	34.95	31.49	29.95

*10 pcs. in 7400 series IC cabinet kit, pg 110 **20 pcs. in 7400 series IC cabinet kit, pg 110

74AC Series

Part No.	Cross Ref.	Pins	Description	Dual-In-Line		
				1	10	100
211801CD	74AC00	14	Quad 2-input NAND gate	\$.20	\$.18	\$.155
211810CD	74AC02	14	Quad 2-input NOR gate	.20	.18	.145
211828CD	74AC04	14	Hex inverter	.18	.15	.12
211836CD	74AC08	14	Quad 2-input AND gate	.19	.17	.14
211844CD	74AC14	14	Hex inverter with Schmitt trigger input	.24	.20	.16
211852CD	74AC32	14	Quad 2-input OR gate	.20	.18	.14
211861CD	74AC74	14	Dual D-type pos. edge-triggered flip-flop	.20	.18	.14
211879CD	74AC86	14	Quad 2-input exclusive OR gate	.20	.18	.14
211887CD	74AC138	16	1 of 8 decoder/demultiplexer	.33	.29	.25
211895CD	74AC240	20	Octal buffer/line driv. w/ 3-st. outputs (2-6V)	.32	.29	.235
211908CD	74AC244	20	Octal buffer/line driv. w/ 3-st. outputs (4.5-5.5V)	.35	.325	.27
211916CD	74AC245	20	Octal bidirectional trans. w/ 3-state I/O	.37	.30	.27
211924CD	74AC273	20	Octal D-type flip-flop	.40	.36	.30
211932CD	74AC373	20	Octal transparent latch w/ 3-state outputs	.40	.36	.30
211941CD	74AC374	20	Octal D-type flip-flop w/ 3-state outputs	.32	.29	.24

74ACT Series

Part No.	Cross Ref.	Pins	Description	Dual-In-Line		
				1	10	100
211959CD	74ACT00	14	Quad 2-input NAND gate	\$.20	\$.18	\$.14
211967CD	74ACT02	14	Quad 2-input NOR gate	.36	.25	.22
211975CD	74ACT04	14	Hex inverter	.21	.19	.15
211983CD	74ACT08	14	Quad 2-input AND gate	.17	.16	.15
211991CD	74ACT14	14	Hex inverter with Schmitt trigger input	.22	.20	.17
212003CD	74ACT32	14	Quad 2-input OR gate	.20	.20	.20
212011CD	74ACT74	14	Dual D-type pos. edge-triggered flip-flop	.20	.18	.14
212020CD	74ACT86	14	Quad 2-input exclusive OR gate	.20	.18	.14
212038CD	74ACT138	16	1 of 8 decoder/demultiplexer	.32	.28	.27
212046CD	74ACT240	20	Octal buffer/line driv. w/ 3-st. outputs (2-6V)	.32	.29	.235
212054CD	74ACT244	20	Octal buffer/line driv. w/ 3-st. outputs (4.5-5.5V)	.35	.325	.27
212062CD	74ACT245	20	Octal bidirectional trans. w/ 3-state I/O	.39	.34	.31
212071CD	74ACT273	20	Octal D-type flip-flop	.63	.44	.37
212089CD	74ACT373	20	Octal transparent latch w/ 3-state outputs	.55	.44	.34
212097CD	74ACT374	20	Octal D-type flip-flop w/ 3-state outputs	.32	.29	.22

74AHC Series

Part No.	Cross Ref.	Pins	Description	Dual-In-Line		
				1	10	100
214092CD	74AHC00N	14	Quad 2-input positive NAND gate	\$.34	\$.29	\$.25
214105CD	74AHC02N	14	Quad 2-input positive NOR gate	.34	.30	.27
214113CD	74AHC04N	14	Hex inverter	.46	.35	.26
214121CD	74AHC08N	14	Quad 2-input positive AND gate	.34	.29	.25
214130CD	74AHC14N	14	Hex inverter with Schmitt trigger input	.34	.32	.26
214148CD	74AHC32N	14	Quad 2-input positive OR gate	.46	.35	.26
214156CD	74AHC74N	14	Dual D-type pos. edge-triggered flip-flop	.29	.27	.25
214164CD	74AHC86N	14	Quad 2-input exclusive OR gate	.37	.32	.28
214172CD	74AHC240N	20	Octal buffer/driver w/ 3-st. outputs	.57	.51	.42
214181CD	74AHC244N	20	Octal buffer/driver w/ 3-st. outputs	.49	.44	.39
214199CD	74AHC245N	20	Octal bus transceiver w/ 3-state outputs	.52	.42	.37
214201CD	74AHC373N	20	Octal transparent D-type latch w/ 3-st. outputs	.42	.39	.37
214210CD	74AHC374N	20	Octal edge-trig. D-type flip-flop w/ 3-st. outputs	.49	.44	.39
214228CD	74AHC541N	20	Octal buffer/driver w/ 3-state outputs	.39	.37	.30
214236CD	74AHC574N	20	Octal edge-trig. D-type flip-flop w/ 3-st. outputs	.59	.49	.39

74AHCT Series

Part No.	Cross Ref.	Pins	Description	Dual-In-Line		
				1	10	100
43844CD	74AHCT00N	14	Quad 2-input positive NAND gate	\$.29	\$.26	\$.23
43852CD	74AHCT02N	14	Quad 2-input positive NOR gate	.29	.26	.23
43861CD	74AHCT04N	14	Hex inverter	.29	.26	.23
63431CD	74AHCT08N	14	Quad 2-input positive AND gate	.29	.266	.25
63458CD	74AHCT14N	14	Hex inverter with Schmitt trigger input	.29	.26	.24
43924CD	74AHCT74N	14	Dual D-type pos. edge-triggered flip-flop	.36	.31	.26
43932CD	74AHCT86N	14	Quad 2-input exclusive OR gate	.37	.33	.28
214244CD	74AHCT240N	20	Octal buffer/driver w/ 3-st. outputs (2-6V)	.49	.45	.39
63466CD	74AHCT244N	20	Octal buffer/driver w/ 3-st. outputs (4.5-5.5V)	.29	.243	.189
43887CD	74AHCT245N	20	Octal bus transceiver w/ 3-state outputs	.41	.39	.35
43908CD	74AHCT373N	20	Octal transparent D-type latch w/ 3-st. outputs	.39	.37	.35
43916CD	74AHCT374N	20	Octal edge-trig. D-type flip-flop w/ 3-st. outputs	.52	.46	.37
214252CD	74AHCT574N	20	Octal edge-trig. D-type flip-flop w/ 3-st. outputs	.52	.46	.37

74C Series

Part No.	Cross Ref.	Pins	Description	Dual-In-Line		
				1	10	100
44222CD	74C00	14	Quad 2-input NAND gate	\$.79	\$.59	\$.41
44231CD	74C04	14	Hex inverter (CD4069)	.79	.59	.41
44257CD	74C14	14	Hex inverter Schmitt trigger (CD40106)	.39	.35	.31
44441CD	74C74	14	Dual D flip-flop	1.59	1.35	1.05
44361CD	74C221	16	Dual monostable multivibrator	3.95	3.59	3.25
13469CD	74C367	16	Hex buffer tri-state (80C97/CD4503)	.39	.34	.29
44396CD	74C373	20	Octal D-type flip-flop with clear tri-state	3.75	3.25	2.49
44409CD	74C374	20	Octal D-type flip-flop tri-state (INS82C06N)	1.69	1.49	1.35
44564CD	74C922	18	16-key keyboard encoder (INS8245N)	6.29	5.05	4.26
44572CD	74C923	20	20-key keyboard encoder (INS8246N)	6.29	5.05	4.25
44581CD	74C925	16	4-digit CTR with MUX D segment driver	6.39	6.25	5.95
44599CD	74C926	18	4-digit CTR with MUX D segment driver	6.95	6.25	5.65

30-Day Money-Back Guarantee

Call for pricing on quantities over 100 – we carry major manufacturers. We will special order any IC – 100 Piece Minimum

74HC Series

Part No.	Cross Ref.	Pins	Description	Dual-In-Line		
				1	10	100
45161CD	74HC00	14	Quad 2-input NAND gate (6231581)	\$.29	\$.19	\$.14
45188CD	74HC02	14	Quad 2-input NOR gate	.29	.15	.10
45209CD	74HC04	14	Hex inverter (buffered)	.25	.22	.19
45225CD	74HC08	14	Quad 2-input AND gate	.19	.17	.15
45233CD	74HC10	14	Triple 3-input NAND gate	.23	.19	.13
45268CD	74HC11	14	Triple 3-input AND gate	.19	.16	.14
45364CD	74HC14	14	Hex inverter Schmitt trigger	.29	.26	.23
45786CD	74HC30	14	8-input NAND gate	.29	.25	.18
45794CD	74HC32	14	Quad 2-input OR gate	.13	.11	.08
46130CD	74HC74	14	Dual D flip-flop	.35	.32	.29
46172CD	74HC85	16	4-bit magnitude comparator	.49	.45	.39
46181CD	74HC86	14	Quad EXCLUSIVE-OR gate	.39	.28	.21
45292CD	74HC123	16	Dual retrigger. monostable multivibrator	.39	.25	.19
45305CD	74HC125	14	Quad bus buffer tri-state	.39	.35	.29
45321CD	74HC132	14	Quad 2-input NAND Schmitt trigger	.35	.30	.22
45330CD	74HC138	16	3-to-8 decoder/demultiplexer	.35	.29	.25
45356CD	74HC139	16	2-to-4 decoder/demultiplexer	.35	.30	.22
45401CD	74HC154	24	4/16 line decoder (.3"W)	1.09	.98	.89
111739CD	74HC154W	24	4/16 line decoder (.6"W)	1.59	1.39	1.19
45428CD	74HC157	16	Quad 2-input multiplexer	.39	.33	.25
45452CD	74HC161	16	Synchronous 4-bit counter	.39	.33	.25
45479CD	74HC163	16	Synchronous 4-bit counter	.49	.45	.40
45487CD	74HC164	14	8-bit serial shift register	.39	.35	.29
45495CD	74HC165	16	Parallel load 8-bit serial shift register	.39	.35	.29
45508CD	74HC174	16	Hex D flip-flop with clear	.49	.42	.31
45541CD	74HC192	16	Decade up/down counter with clear	1.59	1.45	1.29
45559CD	74HC193	16	Binary up/down counter with clear	.59	.54	.49
45604CD	74HC221	16	Dual mono. multivibrator Schmitt trigger	.55	.47	.35
45612CD	74HC240	20	Octal inverting line driver tri-state	.49	.39	.34
45655CD	74HC244	20	Octal driver tri-state	.45	.39	.29
45671CD	74HC245	20	Octal transceiver tri-state	.45	.38	.29
45743CD	74HC273	20	Octal D-type flip-flop with clear	.69	.52	.36
45831CD	74HC373	20	Octal D-type flip-flop tri-state	.45	.39	.35
45858CD	74HC374	20	Octal D-type flip-flop edge-trig tri-state	.49	.39	.29
45874CD	74HC393	14	Dual 4-bit binary counter	.59	.50	.37
109760CD	74HC540	20	Octal invert. buffer/line driver tri-state	.65	.49	.34
46050CD	74HC541	20	Octal buffer/line driver tri-state	.69	.55	.35
46076CD	74HC573	20	Octal D-type flip-flop tri-state	.69	.59	.44
46084CD	74HC574	20	Octal D-type flip-flop tri-state	.59	.50	.38
88090CD	74HC590	16	8-bit binary counter w/ output reg. tri-state	.89	.76	.57
46105CD	74HC595	16	8-bit serial-to-parallel shift reg. tri-state	.62	.44	.39
46113CD	74HC688	20	8-bit mag. comparator	.69	.59	.55
45891CD	74HC4017	16	Decade ctr./div. with 10 decoded outputs	.59	.50	.38
45903CD	74HC4020	16	14-stage binary counter	.59	.45	.34
45920CD	74HC4040	16	12-stage binary counter	.69	.49	.41
45938CD	74HC4046	16	CMOS phase lock loop	.56	.48	.36
88102CD	74HC4051	16	Single 8-channel multi/demultiplexer	.34	.29	.25
45962CD	74HC4060	16	14-stage binary counter	.59	.50	.38
45971CD	74HC4066	14	Quad analog switch	.55	.41	.35
46009CD	74HC4514	S-24	4/16-line decoder with latch (.3"W)	1.95	1.49	1.05
46017CD	74HC4538	16	Dual retrigger. mono. multivibrator	.59	.44	.31

74HCT Series

Part No.	Cross Ref.	Pins	Description	Dual-In-Line		
				1	10	100
* Prepackaged: order in increments of 10 or 100						
44871CD	74HCT00	14	Quad 2-input NAND gate (Y560820T)	\$.29	\$.25	\$.19
44898CD	74HCT04	14	Hex inverter	.29	.25	.19
44901CD	74HCT08	14	Quad 2-input AND gate	.29	.24	.18
44935CD	74HCT14	14	Hex inverter Schmitt trigger	.39	.33	.25
45057CD	74HCT32	14	Quad 2-input OR gate	.34	.29	.22
45137CD	74HCT74	14	Dual D flip-flop	*	.12	.10
44927CD	74HCT138	16	3-to-8 decoder/demultiplexer	.29	.25	.19
63773CD	74HCT139	16	2-to-4 decoder/demultiplexer	.29	.25	.22
88057CD	74HCT154	24	4-to-16 decoder/demultiplexer	.99	.84	.63
45014CD	74HCT240	20	Octal inverting line driver tri-state	.49	.42	.31
45022CD	74HCT244	20	Octal driver tri-state	.39	.33	.24
45031CD	74HCT245	20	Octal transceiver tri-state	.39	.33	.25
45049CD	74HCT273	20	Octal D-type flip-flop with clear	.39	.35	.31
45065CD	74HCT373	20	Octal D-type flip-flop tri-state	.49	.44	.35

74HCT Series (Continued)

Part No.	Cross Ref.	Pins	Description	Dual-In-Line		
				1	10	100
45073CD	74HCT374	20	Octal D-type flip-flop edge-trig. TS	\$.49	\$.39	\$.29
99303CD	74HCT541	20	Octal buffer/line driver tri-state	.69	.59	.39
45090CD	74HCT573	20	Octal D-type latched flip-flop tri-state	.69	.59	.42
45102CD	74HCT574	20	Octal D-type flip-flop edge-trigger tri-state	.69	.59	.44
45129CD	74HCT688	20	8-bit magnitude comparator	.69	.59	.49

74LS Series

Part No.	Cross Ref.	Pins	Description	Dual-In-Line		
				1	10	100
46252CD	74LS00**	14	Quad 2-input NAND gate	\$.29	\$.27	\$.24
46287CD	74LS02**	14	Quad 2-input NOR gate	.29	.25	.21
46308CD	74LS03	14	Quad 2-input NAND gate (O.C.)	.32	.27	.20
46316CD	74LS04**	14	Hex inverter	.29	.26	.23
46341CD	74LS05*	14	Hex inverter (O.C.)	.34	.26	.18
46359CD	74LS06	14	Hex inverter/buffer/driver (O.C.)	.59	.55	.49
46367CD	74LS07	14	Hex buffer/driver (O.C. hi-voltage)	.84	.79	.74
46375CD	74LS08**	14	Quad 2-input AND gate	.36	.31	.29
46391CD	74LS09	14	Quad 2-input AND gate (O.C.)	.25	.21	.16
46404CD	74LS10*	14	Triple 3-input NAND gate	.21	.18	.15
46439CD	74LS11*	14	Triple 3-input AND gate	.31	.28	.25
46640CD	74LS14*	14	Hex inverter Schmitt trigger	.29	.25	.18
47095CD	74LS20*	14	Dual 4-input NAND gate	.23	.18	.14
47108CD	74LS21	14	Dual 4-input AND gate	.21	.18	.14
47378CD	74LS27	14	Triple 3-input NOR gate	.23	.20	.15
47458CD	74LS30*	14	8-input NAND gate	.29	.25	.18
47466CD	74LS32**	14	Quad 2-input OR gate	.29	.26	.23
47597CD	74LS37	14	Quad 2-input NAND gate buffer	.59	.49	.37
47693CD	74LS38	14	Quad 2-input NAND gate buffer (O.C.)	.29	.25	.18
47773CD	74LS42	16	BCD-to-decimal decoder/driver	.69	.59	.49
47790CD	74LS47*	16	BCD to 7-seg. decoder/driver (O.C.)	.72	.52	.45
47811CD	74LS48	16	BCD to 7-seg. decoder/driver	4.99	4.49	3.59
47992CD	74LS73*	14	Dual JK flip-flop with clear	.36	.33	.27
48004CD	74LS74**	14	Dual D flip-flop	.29	.25	.22
48021CD	74LS75*	16	4-bit bi-stable latch	.55	.43	.35
48039CD	74LS76	16	Dual JK flip-flop with preset and clear	.69	.62	.55
48063CD	74LS83	16	4-bit binary full adder	.45	.39	.35
48071CD	74LS85*	16	4-bit magnitude comparator	.39	.29	.25
48098CD	74LS86*	14	Quad EXCLUSIVE-OR gate	.35	.30	.22
48119CD	74LS90*	14	Decade counter	.49	.45	.39
48143CD	74LS92	14	Divide-by-12 counter	.45	.39	.35
48151CD	74LS93*	14	4-bit binary counter	.89	.79	.70
48178CD	74LS95	14	4-bit parallel-access shift register	.89	.79	.69
46412CD	74LS107	14	Dual JK flip-flop with clear	.39	.29	.20
46421CD	74LS109	16	Dual JK pos. edge-trig. flip-flop	.29	.22	.15
46447CD	74LS112	16	Dual JK neg. edge-trig. flip-flop	.29	.22	.15
46471CD	74LS122	14	Retrig. mono. multivibrator comm. CLK	.39	.29	.20
46480CD	74LS123**	16	Dual mono. multivibrator with clear	.33	.28	.21
46501CD	74LS125*	14	Quad bus buffer neg. enable tri-state	.39	.31	.23
46527CD	74LS126	14	Quad bus buffer tri-state	.35	.30	.22
46551CD	74LS132	14	Quad 2-input NAND Schmitt trigger	.35	.26	.18
46586CD	74LS136	14	Quad EXCLUSIVE-OR gate (O.C.)	.49	.44	.31
46607CD	74LS138**	16	3 to 8 decoder/demultiplexer	.38	.35	.29
46623CD	74LS139**	16	2 to 4 decoder/demultiplexer	.36	.31	.23
46666CD	74LS145	16	BCD-to-decimal decoder/driver	.49	.45	.39
46674CD	74LS147	16	10 to 4 priority encoder	2.15	2.05	1.95
46682CD	74LS148	16	8 to 3 priority encoder	.79	.69	.56
46703CD	74LS151*	16	8-input multiplexer	.39	.35	.31
46720CD	74LS153	16	Dual 4-to-1 selector/multiplexer	.29	.25	.18
46738CD	74LS154	24	4 to 16 line decoder/demultiplexer	2.49	2.25	2.05
46754CD	74LS155**	16	Dual 2/4 demultiplexer	.39	.33	.25
46762CD	74LS156	16	Dual 2/4 demultiplexer (O.C.)	.29	.23	.20
46771CD	74LS157*	16	Quad 2/1 data selector	.29	.25	.18
46800CD	74LS160	16	Decade counter with asynch. clear	.89	.79	.69
46818CD	74LS161	16	Synch 4-bit counter	.35	.30	.22
46842CD	74LS163	16	Fully synch. 4-bit counter	.35	.29	.22
46851CD	74LS164	14	8-bit serial shift register	.37	.31	.24
46877CD	74LS165	16	8-bit serial shift register, parallel load	.49	.42	.31
46885CD	74LS166	16	8-bit shift register, parallel load	.39	.32	.22
46906CD	74LS169	16	Synch. binary up/down counter	.64	.55	.41
46922CD	74LS173	16	4-bit D-type reg. tri-state	.49	.44	.39

*10 pcs. in 74LS series IC cabinet kit, pg 110 **20 pcs. in 74LS series IC cabinet kit, pg 110



Call for pricing on quantities over 100 – we carry major manufacturers.

We will special order any IC – 100 Piece Minimum

74LS Series (Continued)

Part No.	Cross Ref.	Pins	Description	Dual-In-Line		
				1	10	100
* Prepackaged: order in increments of 10 or 100						
46931CD	74LS174*	16	Hex D flip-flop with clear	\$.35	\$.28	\$.19
46957CD	74LS175*	16	Quad D flip-flop with clear	.35	.31	.27
46973CD	74LS181	24	Arithmetic logic unit/function generator	1.25	1.05	.71
46990CD	74LS190	16	Synchronous up/down counter	1.49	1.34	1.19
47001CD	74LS191	16	Up/down binary counter	.39	.33	.25
47010CD	74LS192	16	Decade up/down counter with clear	3.95	3.59	3.25
47036CD	74LS193*	16	Binary up/down counter with clear	.59	.49	.45
47052CD	74LS194	16	4-bit bi-directional shift register	.59	.49	.45
47061CD	74LS195	16	4-bit parallel-access shift register	.39	.32	.22
47124CD	74LS221	16	Dual mono. multivibrator Schmitt trigger	.39	.35	.29
47141CD	74LS240*	20	Octal invert. line driver tri-state	.44	.37	.28
47167CD	74LS241	20	Octal bus/line driver tri-state	.39	.33	.24
47183CD	74LS244*	20	Octal driver tri-state	.44	.37	.28
47212CD	74LS245*	20	Octal bus transceiver tri-state	.45	.39	.35
47247CD	74LS247	16	BCD to 7-segment decoder/driver (O.C.)	.79	.69	.49
47271CD	74LS251	16	8-channel multiplexer tri-state	.39	.31	.25
47298CD	74LS257	16	Quad 2-input multiplexer tri-state	.21	.19	.17
47327CD	74LS259	16	8-bit addressable latch	.39	.33	.25
47360CD	74LS266	14	Quad EXCLUSIVE-NOR gate (O.C.)	.39	.29	.25
47386CD	74LS273*	20	Octal D-type flip-flop with clear	.39	.35	.29
47407CD	74LS279	16	Quad set-reset latches	.39	.33	.25
47423CD	74LS283	16	4-bit binary full add with fast carry	.45	.34	.24
47440CD	74LS299	20	8-bit universal shift/storage register	1.19	1.05	.76
47546CD	74LS365	16	Hex buffer with logical OR tri-state	.69	.62	.55
47554CD	74LS366	14	Hex buffer/inverter tri-state	*	.06	.055
47562CD	74LS367	16	Hex buffer tri-state	.39	.33	.25
47600CD	74LS373*	20	Octal D flip-flop tri-state	.45	.39	.35
47634CD	74LS374*	20	Octal D F/F edge-trig tri-state	.45	.39	.34
47669CD	74LS377	20	Octal D register common enable	.53	.45	.34
47722CD	74LS390	16	Dual 4-bit decade counter	.55	.47	.35
47731CD	74LS393	14	Dual 4-bit binary counter	.49	.39	.30
47861CD	74LS540	20	Octal invert. buffer/line driver tri-state	.69	.59	.44
47870CD	74LS541	20	Octal buffer/line driver tri-state	.69	.59	.49
64418CD	74LS573	20	Octal D-type F/F latch tri-state	1.65	1.45	.98
64426CD	74LS574	20	Octal D-type F/F edge-trig. tri-state	1.69	1.45	1.09
47909CD	74LS590	16	8-bit binary counter without reg. tri-state	5.49	4.69	3.55
103974CD	74LS595	16	8-bit serial-to-parallel shift reg. tri-state	4.49	3.99	3.49
47950CD	74LS645	20	Octal bus transceiver tri-state	1.69	1.45	1.09
47984CD	74LS688	20	8-bit magnitude comparator	1.09	.89	.69
* 10 pcs. in 74LS series IC cabinet kit, pg 110						

74S Series

Part No.	Cross Ref.	Pins	Description	Dual-In-Line		
				1	10	100
48531CD	74S188	16	256-bit (32 x 8) PROM O.C. (27S18)	\$4.95	\$4.25	\$3.19
48557CD	74S189	16	64-bit (16 x 4) RAM tri-state (27S03)	3.95	3.49	3.15
48696CD	74S287	16	1k-bit (256 x 4) PROM tri-state (TBP24S10)	6.95	6.25	5.65
48717CD	74S288	16	256-bit (32 x 8) PROM tri-state (TBP18S030N)	2.99	2.55	1.95
52513CD	74S428	28	System contr./bus driver (8228)	2.95	2.55	1.89
48910CD	74S571	16	2k-bit (512 x 4) PROM tri-state (AM27S13)	5.99	5.69	5.39
48928CD	74S573	18	4k-bit (1024 x 4) PROM tri-state (53S441J)	3.05	2.73	2.46

Maxim-Type Interface Series

Part No.	Cross Ref.	Pins	Description	Dual-In-Line		
				1	10	100
142535CD	HIN202CP	16	+5V RS-232 trans. requires 0.1µf caps	\$2.49	\$2.25	\$2.05
24811CD	MAX232CPE	16	+5V powered, dual RS-232 transmitter/receiver (0°C to +70°C)	2.19	1.75	1.45
106155CD	MAX232EPE	16	+5V powered, dual RS-232 transmitter/receiver (-40°C to +85°C)	2.49	2.25	2.05
106163CD	MAX233CPP	20	+5V powered, multichannel RS-232 drivers/receivers (no ext. components)	5.75	5.18	4.66
106171CD	MAX235CPG	24	+5V powered, five RS-232 transmitter/receiver (no ext. components)	9.95	8.95	7.85
106180CD	MAX238CNG	24	+5V powered, quad RS-232 transmitter and receiver	5.25	4.70	3.59
106219CD	MAX690CPA	8	Microprocessor watchdog/battery switchover/reset generator	4.99	4.49	3.25
106227CD	MAX691CPE	16	Microprocessor watchdog/battery switchover/reset generator	6.25	4.35	3.60
106260CD	MAX1232CPA	8	Microprocessor monitor	2.49	2.25	2.05

9000 Series

Part No.	Cross Ref.	Pins	Description	Dual-In-Line		
				1	10	100
53663CD	9368	16	FND70 driver/latch	\$4.49	\$3.95	\$3.55
10567CD	AM9513APC	40	System timing controller	39.95	33.99	25.49

A/D & D/A Converters

Part No.	Cross Ref.	Pins	Description	Dual-In-Line		
				1	10	100
115158CD	AD558JN	16	Microprocessor compat. 8-bit DAC	\$17.99	\$12.75	\$11.49
10145CD	ADC0803LCN	20	8-bit A/D converter (±1/2 LSB)	5.95	5.09	3.79
10153CD	ADC0804LCN	20	8-bit A/D converter (1 LSB)	2.69	2.39	2.09
10170CD	ADC0808CCN	28	8-bit A/D converter with 8-ch. multiflexer	4.99	4.15	3.89
10188CD	ADC0809CCN	28	8-bit A/D converter with 8-ch. multiflexer	2.95	2.75	2.49
10209CD	ADC0817CCN	40	8-bit A/D converter with 16-ch. multiflexer	8.45	7.49	6.99
10225CD	ADC0820CCN	20	8-bit high speed A/D conv. w/ track/hold	3.19	2.75	2.05
116100CD	ADC0831CCN	8	8-bit A/D converter w/ single diff. input	1.95	1.75	1.59
14904CD	DAC0800LCN	16	8-bit D/A converter (±1 LSB)	1.79	1.59	1.45
14912CD	DAC0806LCN	16	8-bit D/A converter (±1 LSB) MC1408P6	1.89	1.65	1.25
14947CD	DAC0808LCN	16	8-bit D/A converter (MC1408P8)	1.59	1.39	1.09
14963CD	DAC0830LCN	20	8-bit µP D/A converter (.05% Lin.)	5.95	4.49	4.35
128186CD	DAC0832LCN	20	8-bit µP D/A conv. dbl. buff. (.05% Lin.)	3.95	3.59	3.25
14980CD	DAC1222LCN	18	12-bit D/A converter (.20% Lin.)	9.95	8.95	8.05
14947CD	MC1408-8	16	8-bit D to A converter (MC1408LCN)	1.59	1.39	1.09
43748CD	7106CPL	40	3 1/2-digit LCD single-chip A/D converter	3.39	2.99	2.49
43756CD	7107CPL	40	3 1/2-digit LED single-chip A/D converter	3.49	2.79	2.59
43764CD	7109CPL	40	12-bit A/D converter	7.99	6.79	5.09
51879CD	8038CCPD	14	Waveform generator/volt control OSC	3.19	2.39	2.19

Digital Interface ICs

Stepper Motor Controllers

Designed to interface a logic level input byte to a stepper motor.

Part No.	Product No.	Pins	Description	1	10	50
141532CD	EDE1200	18	Unipolar stepper motor controller	\$8.95	\$7.95	\$6.95
157526CD	EDE1204	18	Bipolar stepper motor controller	8.95	7.95	6.95

Keypad Encoder

Designed to interface a matrix type 4 row x 4 column (16 key or less) keypad to a microcontroller or other host processor.



Part No.	Product No.	Pins	Description	1	10	50
171969CD	EDE1144	18	Keypad Encoder	\$6.95	\$6.25	\$5.59

Serial LCD Interface

Provides a cost-effective LCD control solution for a wide variety of embedded designs. Allows nearly any-text based LCD module to be controlled via a simple one-wire data link.

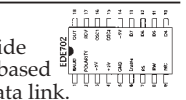

Part No.	Product No.	Pins	Description	1	10	50
171951CD	EDE702	18	Serial LCD Interface	\$8.95	\$7.95	\$6.95

Remote Control Encoders/Decoders

Part No.	Product No.	Pins	Description	1	10	100
123730CD	HT12E	18	Encoder 12-bit	\$1.69	\$1.49	\$1.35
123748CD	HT12D	18	Decoder 8-bit address / 4-bit data	1.69	1.49	1.35
126594CD	HT640	24	Encoder 10-bit address / 8-bit address/data	2.95	2.75	2.49
126607CD	HT648L	24	Decoder 10-bit address / 8-bit latch data	3.29	2.99	2.69

KAE Servo and Stepper Motor Controllers

Controllers operate from standard 8-bit serial interface (RS232 or RS485). Using RS485, any mix of up to 32 controllers may be operated from a single serial port. Complete documentation.

146472CD: PIC-SERVO Motion Control Chipset for DC Motors

- PIC servo control for DC motors with digital encoders
- 32-bit position, velocity, and acceleration resolution
- PWM and direction outputs connect to servo amplifier
- Two chip set (PIC-SERVO 28-pin and PIC-ENC 18-pin)



175901CD: PIC-STEP Motion Control Chip for Stepper Motors

- Step rates up to 50,000 steps/sec. – suitable for use with microstepping drivers
- Trapezoidal positioning and profiled velocity modes
- Programmable current limits automatically switch between holding and running currents • Programmable accelerations and minimum step rates

Part No.	Description	Pins	1	10	50
146472CD	PIC-SERVO chip set, 0.3" DIP	28/18	\$34.95	\$29.95	\$27.95
175901CD	PIC-STEP chip, 0.3" DIP	28	29.95	26.95	24.25

Call for pricing on quantities over 100 – we carry major manufacturers.

We will special order any IC – 100 Piece Minimum

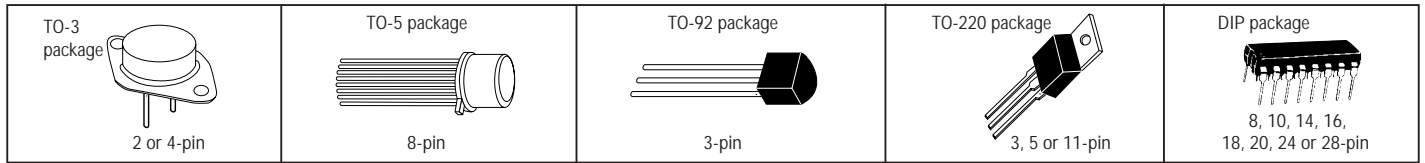

Voltage Regulators

Package (see above)

Part No.	Cross Ref.	Pkg.	Description	1	10	100
23499CD	LM309K	TO-3/2	5V 1A regulator (0°C to +125°C)	\$4.95	\$4.09	\$3.05
192268CD	LM317AT	TO-220/3	3-terminal adjustable reg. (1.2V-37V)	1.95	1.49	1.09
192276CD	LM317HVT	TO-220/3	3-terminal adjustable reg. (1.2V-57V)	2.75	2.05	1.49
23544CD	LM317K	TO-3/2	1.5A adj. pos. reg. (1.2V-37V)	1.89	1.65	1.25
23552CD	LM317LZ	TO-92	100mA adj. pos. reg. (1.2V-37V)	.49	.39	.29
23579CD	LM317T*	TO-220/3	1.5A adj. pos. reg. (1.2V-37V)	.49	.44	.39
23798CD	LM337K	TO-3/2	1.5A/3 term. adj. neg. reg.	3.49	2.99	2.25
23819CD	LM337T*	TO-220/3	1.5A/adj. neg. reg. (-1.2V-37V)	.79	.69	.59
23835CD	LM338K	TO-3/2	5A adj. pos. reg. (1.2V-32V)	3.95	3.59	3.25
192284CD	LM338T	TO-220/3	5A adjustable regulator	2.59	1.95	1.45
23931CD	LM350K	TO-3/2	3A/3 term. adj. pos. reg. (1.2V-33V)	4.39	3.75	2.85
23940CD	LM350T	TO-220/3	3 amp. adj. power regulator	1.75	1.55	1.35
24467CD	LM723CN*	DIP-14	Voltage regulator (2V-37V)	.29	.26	.23
192292CD	LM1086CTADJ	TO-220/3	1.5A low drop out positive regulator	1.29	.89	.69
192305CD	LM1086CT-3.3	TO-220/3	1.5A low drop out positive regulator (3.3V)	1.49	1.09	.85
192313CD	LM1086CT-5.0	TO-220/3	1.5A low drop out positive reg. (5V)	1.29	.89	.69
192330CD	LM2574HVN-5.0	DIP-8	Simple Switcher 0.5A step down volt. reg.	2.99	2.79	2.59
156566CD	LM2574N-5	DIP-8	Step-down 5-voltage regulator	2.49	2.19	1.95
192372CD	LM2576HVT-ADJ	TO-220/5	Simple Switcher 3A step down volt. reg.	3.95	3.39	2.55
192381CD	LM2576HVT-5.0	TO-220/5	Simple Switcher 3A step down volt. reg. (5V)	5.95	4.49	3.59
192399CD	LM2576HVT-12	TO-220/5	Simple Switcher 3A step down volt. reg. (12V)	5.55	4.19	3.19
192410CD	LM2587T-ADJ	TO-220/5	Simple Switcher 5A flyback regulator	5.99	5.49	4.99
192428CD	LM2594N-ADJ	DIP-8	Simple Switcher pwr. conv. 150kHz 0.5A	2.79	2.29	1.99
192452CD	LM2595T-5.0	TO-220/5	Simple Switcher pwr. conv. 150kHz 1A	3.49	2.89	2.49
107166CD	LM2936Z-5	TO-92	Ultra-low quiescent current 5V reg.	1.49	1.29	1.19
107182CD	LM2940CT-5	TO-220/3	5V low dropout reg. (max. 45Vin)	1.29	1.19	1.09
192495CD	LM2940CT-12	TO-220/3	12V low dropout reg. (max 45Vin)	1.39	1.19	.89
121064CD	LM2941CT	TO-220/5	1A low dropout adjustable reg. (45Vin)	1.05	.91	.75
2376CD	LM2941T	TO-220/5	1A low dropout adjustable reg. (60Vin)	1.75	1.39	.99
192524CD	LM3940IT-3.3	TO-220/3	1A low dropout reg. for 5V to 3.3V conv.	2.39	1.69	1.29
51174CD	7660CPA	DIP-8	CMOS volt. convrt. (+5 to ±5V) (M660AN)	.82	.78	.64
51182CD	78L05*	TO-92	5V 100mA pos. voltage regulator	.29	.26	.23
192225CD	78L09	TO-92	9V 100mA pos. voltage regulator	.29	.26	.23
51203CD	78L12*	TO-92	12V 100mA pos. voltage regulator	.25	.21	.16
192233CD	78M05	TO-220/3	5V 500mA pos. voltage regulator	.35	.30	.22
192241CD	78M12	TO-220/3	12V 500mA pos. voltage regulator	.35	.32	.28
192250CD	78M15	TO-220/3	15V 500mA pos. voltage regulator	.35	.30	.22
51238CD	78S40	DIP-16	1.25V-40V 1.5A switching regulator	1.69	1.19	.92
51246CD	7805K	TO-3/2	5V 1A pos. voltage reg. (LM340K-5)	1.69	1.55	1.39
51318CD	7812K	TO-3/2	12V 1A pos. voltage reg. (LM340K-12)	1.69	1.55	1.39
51369CD	7815K	TO-3/2	15V 1A pos. voltage reg. (LM340K-15)	1.39	1.19	.89
51262CD	7805T*	TO-220/3	5V 1A pos. voltage reg. (LM340T-5)	.35	.32	.28
51297CD	7806T	TO-220/3	6V 1A pos. voltage reg. (LM340T-6)	.35	.32	.28
51300CD	7808T*	TO-220/3	8V 1A pos. voltage reg. (LM340T-8)	.35	.32	.28
51334CD	7812T*	TO-220/3	12V 1A pos. voltage reg. (LM340T-12)	.35	.32	.28
51377CD	7815T*	TO-220/3	15V 1A pos. voltage reg. (LM340T-15)	.35	.32	.28
194634CD	7818T	TO-220/3	18V 1A pos. voltage reg. (LM340T-18)	.35	.32	.28
51414CD	7824T	TO-220/3	24V 1A pos. voltage reg. (LM340T-24)	.35	.32	.28
51422CD	79L05	TO-92	5V 100mA neg. voltage regulator	.25	.22	.20
51431CD	79L12	TO-92	12V 100mA neg. voltage regulator	.28	.25	.23
194749CD	79L15	TO-92	15V 100mA neg. voltage regulator	.29	.25	.23
51457CD	7905T*	TO-220/3	5V 1A neg. voltage reg. (LM320T-5)	.39	.35	.29
51481CD	7912T*	TO-220/3	12V 1A neg. voltage reg. (LM320T-12)	.39	.35	.29
51502CD	7915T*	TO-220/3	15V 1A neg. voltage reg. (LM320T-15)	.39	.35	.29

*10 pieces included in Linear kit on page 110

**20 pieces included in Linear kit on page 110

Even lower OEM pricing for larger orders!

Corporate Customers

Call 1-800-831-4242 for details today.

Linear Series

Package (see above)

Part No.	Cross Ref.	Pkg.	Description	1	10	100
23051CD	LH0002CN	DIP-10	General purpose buffer	\$9.95	\$8.95	\$7.95
27852CD	OP07	DIP-8	Ultra-low-offset-voltage op amp.	.99	.89	.79
120715CD	LM10CN	DIP-8	Op amp and voltage reference	5.95	5.39	4.95
23106CD	LM10CLN	DIP-8	Low voltage (1.1 volt) op amp.	3.25	2.75	2.49
25751CD	MF10CN	DIP-20	General purpose dual active filter	3.25	2.75	2.49
120723CD	LM12CLK	TO-3/4	80W op amp.	29.95	27.95	25.95
16301CD	DS0026CN	DIP-8	Dual mos clk. driver (5MHz)(TC426CPA)	1.99	1.69	1.25
115318CD	OP27GP	DIP-8	Low noise prec. op amp (-40°C to 80°C)	1.95	1.75	1.59
107094CD	LM34CZ	TO-92	Prec. F temp. sensor (-40°F to +230°F)	5.49	4.49	4.39
155192CD	LM34DZ	TO-92	Prec. F temp. sensor (+32°F to +212°F)	1.79	1.59	1.19
192217CD	LM35DT	TO-220/3	Prec. C temp. sensor (-55°C to 150°C)	2.79	2.09	1.49
107107CD	LM35CZ	TO-92	Prec. C temp. sensor (-40°C to 110°C)	5.95	5.39	4.95
155740CD	LM35DZ	TO-92	Prec. C temp. sensor (0°C to +100°C)	1.75	1.55	1.35
213090CD	TLO22CP	DIP-8	Dual low power op amp.	1.59	1.25	.95
213102CD	TLO31CP	DIP-8	Enhanced JFET low pwr. low offset op amp.	.72	.65	.53
213111CD	TLO32CP	DIP-8	Enhanced JFET low pwr. low offset op amp.	.95	.85	.71
214068CD	TLO34CN	DIP-14	Enhanced low power low offset op amp.	1.45	1.19	.95
213129CD	TLO52ACP	DIP-8	Enhanced JFET low offset op amp.	4.59	3.65	3.49
213153CD	TLO54ACN	DIP-14	Enhanced JFET low offset op amp.	4.99	3.99	3.39
213145CD	TLO54CN	DIP-14	Enhanced JFET low offset op amp.	1.59	1.35	.99
213137CD	TLO61ACP	DIP-8	Low power JFET input op amp.	.69	.59	.45
33161CD	TLO62CP	DIP-8	Low power JFET op amp. (VCC 8-pin)	.45	.38	.29
33179CD	TLO64CN	DIP-14	Low power JFET input op amp.	.49	.42	.31
213081CD	TLO71ACP	DIP-8	Low noise JFET input op amp.	.49	.44	.36
33187CD	TLO71CP	DIP-8	Low noise JFET op amp.	.39	.35	.29
213073CD	TLO72ACP	DIP-8	Low noise JFET input op amp.	.29	.27	.22
33195CD	TLO72CP*	DIP-8	Low noise JFET dual op amp.	.39	.35	.29
213065CD	TLO74BCN	DIP-14	Low noise JFET input op amp.	.78	.70	.59
33216CD	TLO74CN*	DIP-14	Low noise JFET quad op amp.	.47	.39	.35
213057CD	TLO81ACP	DIP-8	JFET input op amp.	.42	.39	.36
214076CD	TLO82ACP	DIP-8	JFET input op amp.	.59	.52	.42
33232CD	TLO81CP	DIP-8	JFET input op amp.	.39	.35	.31
33241CD	TLO82CP*	DIP-8	JFET input dual op amp.	.49	.45	.39
214084CD	TLO84ACN	DIP-14	JFET input op amp.	.73	.53	.47
33267CD	TLO84CN*	DIP-14	JFET input quad op amp.	.49	.44	.39
212118CD	LM224N	DIP-14	Low power quad op amp.	.22	.19	.17
24811CD	MAX232CPE*	DIP-16	Dual RS-232 receiver/transmitter	2.19	1.75	1.45
212126CD	LM239N	DIP-14	Low pwr. low offset volt quad comp.	.29	.25	.22
212142CD	LM258N	DIP-8	Low power dual op amp.	.27	.24	.21
212151CD	LM301AN	DIP-8	Operational amplifier	.58	.43	.28
23392CD	LM301N*	DIP-8	Improved op amp.	.39	.35	.29
213188CD	LM306N	DIP-8	Differential comparator w/ strobes	.89	.69	.58
23464CD	LM308N*	DIP-8	Precision op amp.	4.49	3.99	3.49
23499CD	LM309K	TO-3/2	5V 1A regulator (0°C to +125°C)	4.95	4.09	3.05
23528CD	LM311N*	DIP-8	Voltage comparator	.35	.25	.19
23608CD	LM318N	DIP-8	Precision hi-speed op amp.	.59	.52	.45
23632CD	LM319N	DIP-14	Hi-speed dual comparator	.45	.40	.31
23667CD	LM323K	TO-3/2	5V 3A positive reg.	3.19	2.78	2.12
212169CD	LM324AN	DIP-14	Low power quad op amp.	.20	.19	.16
23683CD	LM324N**	DIP-14	Low power quad op amp. (ULN4336)	.29	.25	.22
192559CD	LP324N	DIP-14	Micropower quad op amp.	1.39	.99	.75
23721CD	LM331N	DIP-8	Prec. volt to freq. converter (150ppm/°C)	2.55	1.99	1.45
23739CD	LM334Z	TO-92	Adjust current source	.69	.62	.46
120820CD	LM335AZ	TO-92	Precision temperature sensor	2.95	2.75	2.36
23755CD	LM335Z	TO-92	Volt mode temperature sensor	.69	.62	.49
23771CD	LM336Z	TO-92	Voltage reference (2.5V)	.79	.69	.59
143888CD	LM339AN	DIP-14	Low power quad comparator	.18	.17	.155
23851CD	LM339N**	DIP-14	Quad comparator	.29	.25	.22
22904CD	LF347N	DIP-14	Quad JFET input op amp. (wide band)	.53	.48	.44

*10 pcs. in Linear series IC cabinet kit, pg 110

**20 pcs. in Linear series IC cabinet kit, pg 110



Call for pricing on quantities over 100 – we carry major manufacturers. We will special order any IC – 100 Piece Minimum

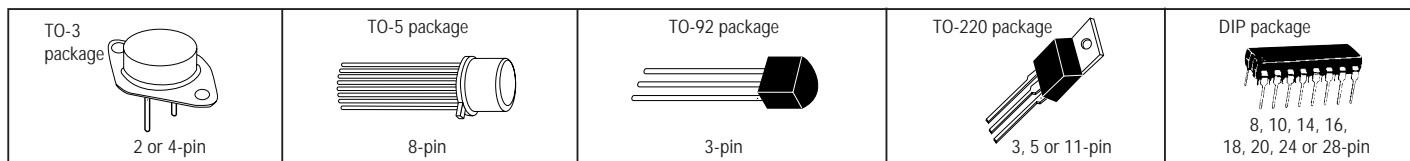

Linear Series (Continued)

Package (see above)

Part No.	Cross Ref.	Pkg.	Description	1	10	100
23915CD	LM348N	DIP-14	Quad 741 op amp. (UPC4741C)	.30	\$.26	\$.20
22912CD	LF351N	DIP-8	BIFET op amp.	.39	.35	.29
22939CD	LF353N*	DIP-8	Dual BIFET op amp. (comp. w/ TL082CP)	.39	.35	.29
22971CD	LF356N*	DIP-8	JFET input op amp. (wide band)	.79	.69	.59
120862CD	LM358AN	DIP-8	Low power dual op amp. (elect improv.)	.69	.59	.49
23966CD	LM358N*	DIP-8	Low power dual op amp.	.18	.13	.11
24037CD	LM380N	DIP-14	2-watt audio power amp.	.99	.75	.55
24088CD	LM383T	TO-220/5	7-watt audio high power amp.	5.95	5.39	4.95
24096CD	LM384N	DIP-14	5-watt audio amp.	1.75	1.55	1.35
120889CD	LM385BZ2.5	TO-92	Volt. ref. diode (2.5V±1.5%)	1.35	1.15	.86
24109CD	LM385Z	TO-92	Volt. ref. diode (2.5V±3%)	.49	.45	.36
24117CD	LM385Z12	TO-92	Micropower volt. ref. diode (1.2V)	.52	.48	.36
24125CD	LM386N-1*	DIP-8	Low voltage audio amp. 250mW/6V	.39	.35	.29
24133CD	LM386N-3*	DIP-8	Low voltage audio amp. 500mW/9V	.69	.59	.49
120900CD	LM392N	DIP-8	Low pwr. op amp./voltage comparator	.99	.89	.75
212177CD	LM393AN	DIP-8	Low pwr. low offset volt dual comparator	.20	.18	.145
24281CD	LM393N*	DIP-8	Dual comparator	.35	.29	.25
23000CD	LF398N	DIP-8	Sample and hold circuit	1.59	1.45	1.15
23018CD	LF411CN*	DIP-8	Low offset drift JFET input op amp.	.79	.69	.59
23026CD	LF412CN*	DIP-8	Low offset drift JFET input dual op amp.	1.35	1.19	.99
33347CD	TL431CLP	TO-92	Program precision reference	.25	.19	.13
106681CD	LF442CN	DIP-8	Dual low power JFET input op amp.	.76	.67	.55
119992CD	LF444CN	DIP-14	Quad low power JFET input op amp.	.74	.65	.52
119984CD	LF444ACN	DIP-14	Quad low power JFET input op amp.	3.95	2.99	2.29
33355CD	TL494CN	DIP-16	Control. ckt. pulse width modulated	.79	.69	.59
27422CD	LM555CN**	DIP-8	Timer (MC1455P/NE555V)	.29	.25	.19
126797CD	LMC555CN*	DIP-8	CMOS 555 timer	.54	.49	.44
34930CD	XRL555	DIP-8	Micro power 555 timer	.89	.79	.69
24328CD	LM556N*	DIP-14	Dual 555 timer (MC3456P)	.49	.45	.39
27457CD	NE558N	DIP-16	Quad timer (NE558C)	.69	.52	.36
27473CD	NE564N	DIP-16	High frequency phase locked loop	1.95	1.75	1.55
24352CD	LM565N	DIP-14	Phased locked loop	1.49	1.29	1.19
24395CD	LM567V	DIP-8	Tone decoder	.49	.40	.37
27490CD	NE571N	DIP-16	Companion, subscriber	3.29	2.99	2.69
115174CD	AD620AN	DIP-8	Low cost instrument amplifier	17.95	15.95	14.35
115182CD	AD633JN	DIP-8	Low cost analog multiplier	7.95	7.19	6.45
143976CD	LMC660CN	DIP-14	CMOS quad operational amp.	1.55	1.39	1.25
120926CD	LM675T	TO-220/5	Power op amp.	6.95	5.25	3.65
214041CD	TL712CP	DIP-8	Differential comparator	1.10	.89	.67
24483CD	LM725CN	DIP-8	Instrumentation op amp.	2.75	2.09	1.45
24491CD	LM733CN	DIP-14	Differential amp.	.99	.89	.79
24521CD	LM741CH	TO-5/8	Op amp.	2.49	1.99	1.79
24539CD	LM741CN**	DIP-8	Op amp. (ULN2151)	.29	.25	.19
24563CD	LM747CN	DIP-14	Dual 741 op amp.	3.65	2.78	2.15
143896CD	LM837N	DIP-14	Low-noise quad operational amp.	1.49	1.35	1.19
25435CD	MC846P	DIP-14	Quad 2-input gate	3.95	2.95	1.95
119706CD	LM1203N	DIP-28	RGB video amp system	1.49	1.39	1.19
24942CD	MC1350P	DIP-8	Video IF amp (12V operation)	1.29	1.19	1.09
23131CD	LM1458N*	DIP-8	Dual op amp. (RC4558)	.29	.26	.22
23157CD	LM1488N*	DIP-14	Quad line driver RS-232 (75188)	.29	.25	.22
16361CD	DS14C88N	DIP-14	Quad CMOS line driver (RS232)	.59	.49	.45
23181CD	LM1489N*	DIP-14	Quad line rec. RS-232 (75189)	.29	.20	.18
16379CD	DS14C89N	DIP-14	Quad CMOS line rec. (RS-232)	.65	.55	.45
118578CD	MC1495L	DIP-14	Linear four quadrant multiplier	9.95	8.95	8.05
23211CD	LM1496N	DIP-14	Balanced mod./demodulator (MC1496P)	.79	.59	.49
23270CD	LM1875T	TO-220/5	20-watt power audio amp.	1.95	1.55	1.25
23288CD	LM1877N-9	DIP-14	Dual power audio amp.	1.55	1.19	.89
107140CD	LM1881N	DIP-8	Video synchronous separator	2.49	1.99	1.49
32897CD	TDA2002V	TO-220/5	8-watt audio high power amp.	1.55	1.39	1.15

* 10 pcs. in Linear series IC cabinet kit, pg 110 ** 20 pcs. in Linear series IC cabinet kit, pg 110

Linear Series (Continued)

Package (see above)

Part No.	Cross Ref.	Pkg.	Description	1	10	100
34278CD	ULN2003A*	DIP-16	Hi-volt/curr. darl. transistor array	\$.39	\$.35	\$.29
34294CD	ULN2004A	DIP-16	Hi-volt/curr. darl. trans. array (XR2204CP)	.32	.29	.25
34972CD	XR2206	DIP-16	Monolithic function generator	3.59	3.29	2.99
34999CD	XR2211	DIP-14	FSK demodulator/tone decoder	1.79	1.59	1.39
39571CD	26LS30	DIP-16	Dual diff RS422 party line Qd RS423 line driv.	2.49	2.25	1.95
39589CD	26LS31	DIP-16	Quad diff line driver	.79	.69	.62
39600CD	26LS32	DIP-16	Quad diff line receiver	.59	.50	.39
34315CD	ULN2803A*	DIP-18	Hi-volt. hi-curr. darl. transistor array	.69	.59	.49
23296CD	LM2901N	DIP-14	Quad comparator	.29	.23	.18
57007CD	LM2902N	DIP-14	Low power quad op amp.	.25	.23	.20
23309CD	LM2903N	DIP-8	Low pwr. low offset volt dual comp.	.20	.17	.135
121005CD	LM2904N	DIP-8	Low power dual op amp.	.23	.21	.19
123625CD	LM2907N-8	DIP-8	Frequency to volt converter	1.95	1.75	1.55
23317CD	LM2907N	DIP-14	Frequency to volt converter	1.75	1.59	1.29
23350CD	LM2917N-8	DIP-8	Frequency to volt converter	2.45	1.75	1.25
23341CD	LM2917N-14	DIP-14	Frequency to volt converter	1.79	1.49	1.29
12079CD	CA3046N	DIP-14	NPN transistor array (ULN2046)	.49	.44	.39
12116CD	CA3080E	DIP-8	Op transconductance amp. (100135)	.65	.55	.46
12124CD	CA3081N	DIP-16	Common emitter NPN array (ULN2081)	.69	.59	.54
12159CD	CA3086N	DIP-14	Transistor array NPN (ULN2086)	.49	.42	.31
12183CD	CA3130E	DIP-8	CMOS op amp.	.75	.72	.69
12204CD	CA3140E	DIP-8	Bi-MOS op amp.	.79	.71	.63
12239CD	CA3161E	DIP-16	BCD to 7-seg. decoder driver	2.19	1.95	1.75
12247CD	CA3162E	DIP-16	Dual slope & rate analog/digital convert	6.95	5.95	5.25
107238CD	LM3302N	DIP-14	Low pwr. low offset volt quad comp.	.20	.15	.11
212185CD	MC3303N	DIP-14	Quad bipolar op amp.	.45	.39	.29
24168CD	CA3401N	DIP-14	Quad amp (LM3900N) (221-235)	.79	.69	.62
212193CD	MC3403N	DIP-14	Quad bipolar op amp.	.35	.31	.27
25216CD	MC3479P	DIP-16	Biphase stepper motor driver	5.75	5.18	4.65
25232CD	MC3486P	DIP-16	Quad EIA-422/423 line rec. w/ 3-st. outputs	.59	.49	.45
25259CD	MC3487P	DIP-16	Quad EIA-422 line driver w/ 3-state outputs	.69	.59	.45
31974CD	SG3524	DIP-16	Regulating pulse width modulator	.65	.59	.51
126834CD	LM3876T	TO-220/11	40W high perf. audio amp. with mute	4.79	3.89	3.59
192516CD	LM3886T	TO-220/11	68W high perf. audio amp. with mute	5.19	3.95	2.95
24168CD	LM3900N	DIP-14	Quad amp. (CA3401)	.79	.69	.62
24230CD	LM3914N	DIP-18	Bar-graph display driver	2.25	2.02	1.82
24256CD	LM3915N	DIP-18	3 dB steps bar-graph disp. driver	2.49	1.99	1.55
24272CD	LM3916N	DIP-18	VU meter display driver	2.25	1.95	1.75
25275CD	MC4044P	DIP-14	Frequency phase detector (11C44)	9.99	7.49	5.25
29356CD	RC4136N	DIP-14	Quad op amp (XR4136)	.85	.77	.65
29372CD	RC4151NB	DIP-8	Volt to freq. converter (XR4151)	1.29	1.19	1.09
27385CD	NE5532*	DIP-8	Dual low noise op amp.	.49	.43	.39
27406CD	NE5534	DIP-8	Low noise op amp.	.79	.69	.59
43801CD	7217AIP1	DIP-28	4-digit LED up/down cntr. (com. cathode)	11.95	10.75	9.69
51140CD	75551PA	DIP-8	CMOS timer (LM555CN)	.59	.49	.45
51879CD	8038CCPD	DIP-14	Precision wave form generator	3.19	2.39	2.19
213170CD	UA9636A	DIP-8	Dual differential line receiver (MC3488A)	.79	.69	.55
192532CD	LM13700N	DIP-16	Dual op transcon. amp. w/ diodes & buffer	1.65	1.19	.89
25021CD	MC14411P	DIP-24	Bit rate frequency generator	6.95	5.95	4.45
25064CD	MC14490P	DIP-16	Hex contact bounce eliminator	6.95	6.25	5.59
50884CD	75154	DIP-16	Quad line receiver	.79	.69	.50
50930CD	75173	DIP-16	Quadruple differ. line receiver	1.99	1.59	1.29
50948CD	75174	DIP-16	Quad diff. RS-422 line driver w/ 3-state out	1.08	.99	.88
50956CD	75175	DIP-16	Quad diff. EIA 422A/423A line rec. w/3-st.out	1.05	.80	.70
50964CD	75176	DIP-8	Differential bus transceiver	.79	.67	.50
23157CD	75188	DIP-14	Quad line driver RS-232 (LM1488N)	.29	.25	.22
23181CD	75189	DIP-14	Quad line rec. RS-232 (LM1489N)	.29	.20	.18
51027CD	75451	DIP-8	Dual peripheral AND driver	.49	.44	.39
51035CD	75452	DIP-8	Dual peripheral NAND driver	.45	.39	.29

* 10 pcs. in Linear series IC cabinet kit, pg 110

Call for pricing on quantities over 100 – we carry major manufacturers. We will special order any IC – 100 Piece Minimum

Linear Series (Continued)

Part No.	Cross Ref.	Pkg.	Description	Package (See left)		
				1	10	100
51131CD	75492	DIP-14	Hex digit driver (492)	\$6.95	\$6.25	\$5.95
118586CD	MC145151P	DIP-28	Parallel input PLL freq. synthesizer	5.95	5.39	4.85
25099CD	MC145406P	DIP-16	RS232-C/V.28 driv./rec. (CMOS) (75C1406N)	1.95	1.75	1.59
25101CD	MC146818	DIP-24	Real time clock plus RAM	4.95	3.75	3.19

EPSON Real Time Clock Modules

RTC58321B: 16-Pin Clock Module

- Frequency stability: ±50ppm
- Built-in 32.768kHz quartz crystal
- Addressable counter start, stop, and reset function
- 12 or 24-hour format
- Automatic leap year setting
- Microprocessor compatible 4-bit data bus

Part No.	Product No.	Description	1	10	50
29591CD	RTC58321B	16-pin clock module	\$7.39	\$6.15	\$5.49

RTC72421B: 18-Pin Clock Module

- Frequency stability: ±50ppm
- Built-in quartz crystal makes board design easy
- Direct bus-compatibility (120 nsec access time)
- Interrupt masking
- 30 seconds error adjustment function

Part No.	Product No.	Description	1	10	50
95530CD	RTC72421B	18-pin clock module	\$6.49	\$5.69	\$4.99

Call us with your 100 piece minimum order.

We'll Find Any IC!

1-800-831-4242



Dallas Semiconductor

Dual-In-Line

Part No.	Product No.	Pins	Description	Dual-In-Line		
				1	10	100
114198CD	DS1210	8	Nonvolatile controller chip	\$3.95	\$3.59	\$3.25
114219CD	DS1213C	28	SmartSocket 64K/256k	16.95	15.29	12.19
133410CD	DS1216C	28	Smartwatch/RAM 64K/256k	29.49	27.39	16.45
114331CD	DS1232	8	Micromonitor chip	2.16	1.95	1.75
133444CD	DS1286	28	Watchdog timekeeper (50-Byte RAM)	21.49	18.29	13.75
76646CD	DS1287	24	Real time clock with RAM (MC146818A)	5.95	5.09	3.79
176778CD	DS1302	8	Trickle charge time keeping IC	2.49	2.25	2.05
114374CD	DS1387	24	RAMified real time clock 4kx8	8.95	8.15	7.25
114382CD	DS1620	8	Digital thermometer and thermostat	5.49	4.95	3.89
133452CD	DS12887	24	Real time clock chip	6.95	6.25	5.65
114403CD	DS80C320-MCG	40	High speed micro 25MHz	14.95	7.65	7.39

5000 Series and Clock Chips

Part No.	Cross Ref.	Pins	Description	Dual-In-Line		
				1	10	50
32803CD	TCM5089N	16	Integrated tone dialer chip	\$4.95	\$4.49	\$4.05
26091CD	MM5321N	16	TV camera synchronous generator	7.95	6.79	5.09
26171CD	MM5450N	40	34-segment LED display driver	4.95	4.49	4.05
26201CD	MM58167AN	24	Microprocessor real time clock	4.95	4.25	3.19
29591CD	RTC58321B	16	Real time clock module (see above)	7.39	6.15	5.49
95530CD	RTC72421B	18	Real time clock module (see above)	6.49	5.69	4.99



See page 110 for 7400, 74LS, 4000 and Linear Series IC Cabinet Kits.

Heat Sinks

Heat Sink Compound

Thermally loaded silicone-based grease that improves transfer of energy across the metal to metal interface between transistor or rectifier to heat sink.

- Color: opaque white

Part No.	Product No.	1	10	100
196752CD	THM249 (1 oz.)	\$4.95	\$4.49	\$3.95
167249CD	THM250 (2 oz.)	9.95	8.99	8.09



Heat Sink Compound 4-Oz. Tube

This silicone-free compound provides more effective heat transfer. Will not harden, dry out, melt, or contaminate wave-solder baths.

Part No.	Product No.	1	10
169252CD	1978DP	\$17.95	\$15.95

Heat Sink Mounting Kits



- TO-3 and TO-220 heat sink insulator assemblies
- 10 kits per pack

Part No.	Type	Description	1	10	100
34121CD	TO-220	5-piece kit	\$3.95	\$3.55	\$3.19
34139CD	TO-3	12-piece kit	3.95	3.59	3.25

Thermalloy

IERC

Heat Sinks

AAVID

Wakefield

Our TO-3/TO-218/TO-220 heat sinks are made from black anodized aluminum (except for P/N 102797CD which is light weight aluminum). They can be mounted horizontally or vertically according to your applications. P/N 164734CD and 163846CD have mounting clips and some can be mounted vertically with solderable mounting tabs.



Part No.	Mfr. Cross Reference No.	Type	Watts	Size (L" x W" x H")	Pricing			
					1	10	100	1000
16512CD	DUDE4	TO-3	30.0	4.8 x 1.5 x 1.3	\$2.95	\$2.75	\$2.49	\$2.25
189835CD	635-5B2	TO-3	8.0	1.9 x 1.4 x 0.5	.95	.86	.68	.51
151546CD	635-125B2	TO-3	8.0	1.9 x 1.4 x 1.3	.99	.89	.67	.60
163846CD	THM7021B	TO-218/220	5.0	1.7 x 1.8 x 0.4	.59	.53	.48	.43
42622CD	6030B	TO-220	3.9	1.2 x 1.0 x 0.5	.32	.29	.26	.24
40504CD	291-36H	TO-220	2.0	0.9 x 1.0 x 0.4	.89	.79	.69	.59
158051CD	THM6078	TO-220	2.0	.75 x .52 x .38	.39	.35	.29	.25
70914CD	THM6106	TO-220	1.9	1.2 x 1.0 x 0.5	.36	.32	.27	.23
70658CD	THM6073	TO-220	1.6	0.8 x 0.7 x 0.4	.38	.27	.18	.14
129242CD	THM6106	TO-220	1.6	1.2 x 1.0 x 0.5	.49	.45	.39	.35
107297CD	PSC2-U (cup-style)	TO-220	1.5	0.8 x 1.0 x 0.4	.49	.45	.39	.35
164734CD	THM6072	TO-220	5.0	1.4 x 1.8 x 0.4	.59	.53	.48	.43

Jameco Special Values!

See the yellow & green highlighted items. Details on page 4.

Transistors



Call for pricing on quantities over 5000 – we carry major manufacturers.
Any transistor may be supplied in ammo style tape by special order – 1000 piece min.



14-pin DIP



TO-3

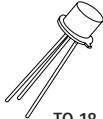

TO-18

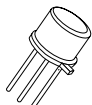

TO-39



TO-72

SALE

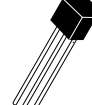

TO-92



TO-126/TO-225

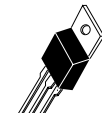

TO-220



TO-237

* Prepackaged: order in increments of 10, 100 or 1000

* Prepackaged: order in increments of 10, 100 or 1000

Part No.	Product No.	Mfr.	Case	Desc.	Vceo	Min. f_{FE} @ Ic	Pricing			
							1	10	100	1000
26462CD	MPSA06	◆	TO-92	NPN	30	50 @ .01A	*	\$.14	\$.12	\$.11
26489CD	MPSA13	◆	TO-92	NPN	30	5k @ .01A	*	.07	.05	.04
210593CD	MPSA14	◆	TO-92	NPN	30	20k @ .10A	*	.045	.032	.021
210681CD	MPSA18	◆	TO-92	NPN	45	500 @ .001A	*	.06	.036	.024
33021CD	TIP29A	◆	TO-220	NPN	60	15 @ 1A	*	.49	.45	.41
33030CD	TIP30A	◆	TO-220	PNP	60	15 @ 1A	*	.54	.50	.45
179346CD	TIP30C	SAM	TO-220	PNP	100	15 @ 1A	*	.49	.45	.39
33048CD	TIP31A	◆	TO-220	NPN	60	10 @ 3A	*	.49	.39	.29
179354CD	TIP31C	SAM	TO-220	NPN	100	10 @ 3A	*	.52	.39	.27
33064CD	TIP32A	◆	TO-220	PNP	60	10 @ 3A	*	.49	.44	.39
181841CD	TIP32C	◆	TO-220	PNP	100	10 @ 3A	*	.53	.39	.27
179371CD	TIP41C	SAM	TO-220	NPN	100	15 @ 3A	*	.65	.53	.45
33081CD	TIP41A	◆	TO-220	NPN	60	15 @ 3A	*	.59	.45	.29
178546CD	MPSA42	◆	TO-92	NPN	30	40 @ .03A	*	.22	.19	.15
33101CD	TIP42A	◆	TO-220	PNP	60	15 @ 3A	*	.59	.49	.39
139580CD	TIP42C	◆	TO-220	PNP	100	15 @ 3A	*	.49	.45	.39
179389CD	TIP42C	SAM	TO-220	PNP	100	15 @ 3A	*	.55	.50	.45
210606CD	MPSA56	◆	TO-92	PNP	80	100 @ .10A	*	.049	.034	.024
210614CD	MPSA64	◆	TO-92	PNP	30	20k @ .10A	*	.053	.035	.024
120221CD	BPW77	◆	TO-18	NPN	70	—		1.95	1.75	1.49
178554CD	MPSA92	◆	TO-92	PNP	300	25 @ .003A	*	.067	.048	.029
214033CD	MPSA93	◆	TO-92	PNP	200	25 @ .03A	*	.063	.049	.032
32977CD	TIP102	◆	TO-220	NPN	100	1k @ 3A	*	.43	.36	.28
179240CD	TIP102	SAM	TO-220	NPN	100	1k @ 3A	*	.67	.62	.57
32985CD	TIP106	◆	TO-220	NPN	80	1k @ 3A	*	.59	.54	.49
179258CD	TIP107	SAM	TO-220	PNP	100	1k @ 3A	*	.67	.62	.57
32993CD	TIP120	◆	TO-220	NPN	60	1k @ 3A	*	.54	.49	.43
179291CD	TIP120	SAM	TO-220	NPN	60	1k @ 3A	*	.55	.48	.42
120416CD	TIP122	◆	TO-220	NPN	100	1k @ 3A	*	.38	.32	.22
179303CD	TIP122	SAM	TO-220	NPN	100	1k @ 3A	*	.58	.43	.29
33013CD	TIP125	◆	TO-220	PNP	60	1k @ 3A	*	.49	.45	.29
179320CD	TIP127	SAM	TO-220	PNP	100	1k @ 3A	*	.55	.49	.45
211529CD	MJE340	◆	TO-225	NPN	300	30 @ .05A	*	.30	.28	.23
211537CD	MJE350	◆	TO-225	PNP	300	30 @ .05A	*	.26	.25	.245
211545CD	MJE700	◆	TO-225	PNP	60	750 @ 1.5A	*	.28	.25	.235
211553CD	MJE800	◆	TO-225	NPN	60	750 @ 1.5A	*	.29	.25	.22
194327CD	2N2102	◆	TO-39	NPN	65	40 @ .15A	*	.39	.35	.29
38228CD	2N2219A	◆	TO-39	NPN	40	100 @ .15A	*	.59	.49	.39
26446CD	MPQ2222	◆	DIP-14	NPN	40	100 @ .15A	*	2.55	2.29	1.99
210665CD	MPS2222	◆	TO-92	NPN	40	30 @ .50A	*	.054	.038	.036
28628CD	PN2222	◆	TO-92	NPN	30	100 @ .15A	*	.045	.027	.025
210673CD	MPS2222A	◆	TO-92	NPN	40	40 @ .50A	*	.07	.055	.045
178511CD	PN2222A	◆	TO-92	NPN	40	100 @ .15A	*	.09	.06	.04
38236CD	2N2222A	◆	TO-18	NPN	40	100 @ .15A	*	.39	.35	.29
26526CD	MPS2369	◆	TO-92	NPN	15	20 @ .10A	*	.29	.25	.18
211334CD	MPS2369A	◆	TO-92	NPN	15	20 @ .10A	*	.29	.22	.17
194378CD	2N2905A	◆	TO-39	PNP	60	100 @ .15A	*	.55	.50	.45
26454CD	MPQ2907	◆	DIP-14	PNP	40	100 @ .15A	*	1.69	1.55	1.39
28644CD	PN2907	◆	TO-92	PNP	40	100 @ .15A	*	.13	.12	.11
211342CD	MPS2907A	◆	TO-92	PNP	60	100 @ .15A	*	.063	.045	.035
178520CD	PN2907A	◆	TO-92	PNP	60	100 @ .15A	*	.09	.06	.04
38279CD	2N2907A	◆	TO-18	PNP	60	100 @ .15A	*	.36	.34	.31
211377CD	TIP2955	◆	TO-220	PNP	60	5 @ .001A	*	1.15	1.05	.96
211502CD	MJ2955A	◆	TO-3	NPN	60	20 @ 4A	*	1.07	1.00	.96

◆ Manufacturer varies SAM = Samsung FSC = Fairchild Semiconductor

Part No.	Product No.	Mfr.	Case	Desc.	Vceo	Min. f_{FE} @ Ic	Pricing			
							1	10	100	1000
25831CD	MJE2955T	◆	TO-220	PNP	60	20 @ 4A	*\$.59	\$.53	\$.42	\$.32
38295CD	2N3053	◆	TO-39	NPN	40	25 @ .15A	.65	.59	.52	.46
211385CD	TIP3055	◆	TO-220	NPN	60	5 @ .001A	1.15	1.05	.96	.78
38308CD	2N3055	◆	TO-3	NPN	60	15 @ 10A	1.09	.87	.65	.46
211406CD	2N3055A	◆	TO-3	NPN	60	20 @ 4A	1.18	1.15	1.13	1.03
25857CD	MJE3055T	◆	TO-220	NPN	60	20 @ 4A	.57	.51	.45	.40
194415CD	2N3439	◆	TO-39	NPN	350	40 @ .02A	.41	.37	.34	.34
194423CD	2N3440	◆	TO-39	NPN	250	40 @ .02A	.47	.42	.39	.35
211561CD	MPS3646	◆	TO-92	NPN	15	30 @ .003A	.29	.24	.19	.17
194458CD	2N3700	◆	TO-18	NPN	80	100 @ .15A	.59	.54	.46	.41
209242CD	2N3771	◆	TO-3	NPN	40	15 @ 15A	1.99	1.86	1.75	1.40
38324CD	2N3772	◆	TO-3	NPN	40	15 @ 10A	1.49	1.35	1.19	.99
140151CD	2N3773	◆	TO-3	NPN	140	15 @ 8A	2.49	2.25	1.79	1.35
62279CD	2N3903	◆	TO-92	NPN	40	50 @ .01A	*	.045	.039	.025
211351CD	MPS3904	◆	TO-92	NPN	40	100 @ .001A	.29	.275	.26	.21
38359CD	2N3904	◆	TO-92	NPN	40	100 @ .01A	*	.08	.06	.045
178597CD	2N3904	FSC	TO-92	NPN	40	100 @ .01A	*	.09	.08	.07
62287CD	2N3905	◆	TO-92	PNP	40	50 @ .01A	*	.054	.037	.024
211369CD	MPS3906	◆	TO-92	PNP	40	100 @ .001A	*	.10	.08	.055
38375CD	2N3906	◆	TO-92	PNP	40	100 @ .01A	*	.05	.04	.03
178618CD	2N3906	FSC	TO-92	PNP	40	100 @ .01A	*	.09	.08	.07
194466CD	2N4033	◆	TO-39	PNP	80	100 @ .10A	.69	.59	.49	.39
38404CD	2N4123	◆	TO-92	NPN	30	25 @ .05A	*	.059	.039	.025
62295	2N4124	◆	TO-92	NPN	25	60 @ .05A	*	.059	.039	.025
38421CD	2N4401	◆	TO-92	NPN	40	100 @ .15A	*	.07	.06	.05
38447CD	2N4403	◆	TO-92	PNP	40	100 @ .15A	*	.08	.06	.07
211511CD	2N4410	◆	TO-92	NPN	80	60 @ .01A	*	.06	.042	.032
211449CD	2N4918	◆	TO-225	PNP	40	30 @ .50A	.49	.45	.42	.37
211457CD	2N4919	◆	TO-225	PNP	60	30 @ .50A	.36	.34	.32	.30
211465CD	2N4920	◆	TO-225	PNP	80	30 @ .50A	.33	.315	.30	.29
211473CD	2N4921	◆	TO-225	NPN	40	30 @ .50A	.34	.33	.32	.31
211481CD	2N4922	◆	TO-225	NPN	60	30 @ .50A	.35	.33	.29	.265
214623CD	2N4126	◆	TO-92	PNP	25	60 @ .05A	*	.054	.037	.024
211490CD	2N4923	◆	TO-225	NPN	80	30 @ .50A	.35	.31	.26	.24
210631CD	2N5087	◆	TO-92	PNP	50	250 @ .10A	*	.055	.038	.028
62316CD	2N5088	◆	TO-92	NPN	30	300 @ .10A	*	.055	.038	.025
62324CD	2N5089	◆	TO-92	NPN	25	400 @ .10A	*	.055	.038	.027
38480CD	PN5179	◆	TO-92	NPN	15	25 @ .003A	1.19	1.09	.85	.61
140373CD	2N5179	◆	TO-72	NPN	12	25 @ .003A	.69	.65	.59	.49
209251CD	2N5191	◆	TO-225	NPN	60	25 @ 1.5A	.39	.35	.32	.30
38498CD	2N5192	◆	TO-225	NPN	80	20 @ 1.5A	.35	.34	.31	.289
209269CD	2N5194	◆	TO-225	PNP	60	25 @ 1.5A	.33	.31	.295	.28
38501CD	2N5195	◆	TO-225	PNP	80	20 @ 1.5A	.47	.44	.40	.33
210649CD	2N5401	◆	TO-92	PNP	150	60 @ .01A	*	.053	.044	.032
194546CD	2N5415	◆	TO-39	PNP	200	30 @ .05A	.63	.57	.51	.46
210657CD	2N5551	◆	TO-92	NPN	160	80 @ .01A	*	.07	.045	.034
209277CD	2N5657	◆	TO-126	NPN	350	30 @ .10A	.49	.45	.39	.35
194571CD	2N6042	◆	TO-220	PNP	100	1k @ 3A	.65	.59	.51	.49
194589CD	2N6045	◆	TO-220	NPN	100	1k @ 3A	1.19	.99	.91	.84
194597CD	2N6052	◆	TO-3	PNP	100	750 @ 6A	2.95	2.66	2.39	2.15
194600CD	2N6059	◆	TO-3	NPN	100	750 @ 6A	2.15	1.95	1.79	1.71
194618CD	2N6547	◆	TO-3	NPN	400	12 @ 5A	3.99	3.79	3.49	3.49
194626CD	2N6678	◆	TO-3	NPN	400	8 @ 15A	6.25	5.63	5.06	4.56
140134CD	2N6725	◆	TO-237	NPN	50	25k @ .2A	.60	.55	.49	.44

Call for pricing on quantities over 5000 - we carry major manufacturers.

SALE

J-FET



• TO-92 case (except P/N 38341CD: TO-72 case)

* Prepackaged: order in increments of 10, 100 or 1000

Part No.	Mfr. Cross Ref. No.	Description	BV _{GS} (V)min @ IGUA	I _{SS} (max) (mA) @ V _{DS}	VP (max) @ V _{DS}	Pricing			
						1	10	100	1000
210622CD	2N3819	JFET (N-Ch)	25 @ 1	20 @ 15	—	*	\$.09	\$.06	\$.038
38341CD	2N3823	JFET (N-Ch)	30 @ 1	20 @ 15	8 @ 0.5	.89	.84	.79	.75
38527CD	2N5951	JFET (N-Ch)	30 @ 1	13 @ 15	5 @ 100	.99	.89	.79	.69
26403CD	MPPF102	JFET (N-Ch)	25 @ 1	20 @ 15	4 @ 0.5	.26	.19	.14	.14
211393CD	J111	JFET (N-Ch)	35 @ 1	20 @ 15	—	.29	.22	.16	.11
140450CD	J112	JFET (N-Ch)	35 @ 1	5.0 @ 15	—	.29	.22	.16	.11
140142CD	J176	JFET (P-Ch)	30 @ 1	2 @ 25	4 @ -15	.59	.55	.49	.45
211414CD	J177	JFET (P-Ch)	30 @ 1	20 @ 15	—	.29	.22	.16	.11

Power Transistors



Part No.	Mfr. Cross Ref. No.	Case	Intrinsic Standoff ratio	Pk. Pt. Curr. (max) 5.0µA	Valley Pt. Curr. (min) 4.0mA	Pricing			
						1	10	100	1000
194511CD	2N4871	TO-92	0.70 (min)	5.0µA	4.0mA	\$1.35	\$1.25	\$1.15	\$1.05

N-Channel MOSFETs

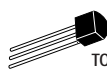

* Prepackaged: order in increments of 10, 100 or 1000

Part No.	Prod. No.	Mfr.	Case	Drain Source Brkdwn Volt.	Min. On-State DS Current	Pricing			
						1	10	100	1000
178669CD	2N7000	FSC	TO-92	60VDC	0.2A	*	\$.12	\$.11	\$.10
119423CD	2N7000	✦	TO-92	60VDC	0.3A	.21	.17	.12	.10
209058CD	BUZ72L	✦	TO-220	100VDC	10.0A	.69	.55	.45	.39
209234CD	IRF510	✦	TO-220	100VDC	5.6A	.53	.48	.39	.34
209226CD	IRF520	✦	TO-220	100VDC	10.0A	.55	.52	.48	.39
210500CD	IRF530	✦	TO-220	100VDC	14.0A	.70	.65	.60	.49
210518CD	IRF540	✦	TO-220	100VDC	27.0A	.81	.73	.54	.51
210526CD	IRF620	✦	TO-220	200VDC	6.0A	.44	.40	.32	.29
210534CD	IRF630	✦	TO-220	200VDC	9.0A	.65	.55	.45	.43
210542CD	IRF640	✦	TO-220	200VDC	18.0A	.99	.92	.85	.69
210551CD	IRF730	✦	TO-220	400VDC	5.5A	.79	.69	.56	.52
210569CD	IRF740	✦	TO-220	400VDC	10.0A	1.25	1.10	.89	.80
210577CD	IRF820	✦	TO-220	500VDC	4.0A	.65	.60	.55	.45
210585CD	IRF830	✦	TO-220	500VDC	4.5A	.77	.70	.62	.58
184719CD	IRF840	✦	TO-220	500VDC	8.0A	1.49	1.29	.99	.89

✦ Manufacturer varies FSC = Fairchild Semiconductor

Rectifiers

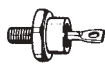

Rectifiers

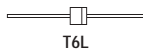
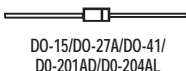

* Prepackaged: order in increments of 10, 100 or 1000

Part No.	Product No.	Mfr.	Case	Description	Pricing			
					1	10	100	1000
35924CD	1N1188	✦	DO-5	400 PRV, 35A	\$2.89	\$2.59	\$2.35	\$2.10
35975CD	1N4001	✦	DO-41	50 PRV, 1A	*	.03	.025	.02
76961CD	1N4002	✦	DO-41	100 PRV, 1A	*	.03	.025	.02
76970CD	1N4003	✦	DO-41	200 PRV, 1A	*	.04	.025	.02
35991CD	1N4004	✦	DO-41	400 PRV, 1A	*	.04	.025	.02
76988CD	1N4005	✦	DO-41	600 PRV, 1A	*	.04	.025	.02
76996CD	1N4006	✦	DO-41	800 PRV, 1A	*	.04	.03	.02
36011CD	1N4007	✦	DO-41	1000 PRV, 1A	*	.04	.03	.025
214543CD	1N5399	✦	DO-15	1000 PRV, 1.5A	*	.054	.038	.028
77075CD	1N5400	✦	DO-27A	50 PRV, 3A	*	.15	.12	.06
36249CD	1N5401	✦	DO-27A	100 PIV, 3A	*	.14	.11	.06
77083CD	1N5402	✦	DO-27A	200 PRV, 3A	*	.11	.07	.06
36265CD	1N5404	✦	DO-27A	400 PRV, 3A	*	.11	.07	.055
36273CD	1N5408	✦	DO-27A	1000 PRV, 3A	*	.15	.11	.08
177949CD	1N5817	✦	DO-204AL	20 PIV, 1A	.19	.17	.16	.13
177957CD	1N5818	✦	DO-204AL	30 PIV, 1A	.24	.20	.16	.15
177965CD	1N5819	✦	DO-204AL	40 PIV, 1A	.19	.17	.16	.13
177973CD	1N5820	✦	DO-201AD	20 PIV, 3A	.29	.25	.19	.16
177981CD	1N5821	✦	DO-201AD	30 PIV, 3A	.29	.25	.19	.16
177990CD	1N5822	✦	DO-201AD	40 PIV, 3A	.49	.45	.39	.35
177754CD	T6A05L	✦	T6L	50 PIV, 6A	.31	.28	.25	.23
177762CD	T6A10L	✦	T6L	100 PIV, 6A	.31	.28	.23	.20
177818CD	T6A100L	✦	T6L	1000 PIV, 6A	.49	.44	.40	.33
177885CD	UF4002	✦	DO-41	100 PIV, 1A	*	.09	.08	.07
177906CD	UF4004	✦	DO-41	400 PIV, 1A	*	.09	.08	.07
177922CD	UF4006	✦	DO-41	800 PIV, 1A	*	.09	.08	.07

✦ Manufacturer varies

Don't worry about backorders. Over 99% of our products are in stock.

We'll Send It Today!

Just place your order by 6PM EST for same business day shipment.



Bridge Rectifiers

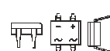

Part No.	Product No.	Mfr.	Case*	Description	Pricing			
					1	10	100	1000
178001CD	DF005M	✦	DF	50 PIV, 1A	\$.29	\$.27	\$.25	\$.18
103000CD	DF01M	✦	DF	100 PIV, 1A	.39	.35	.29	.22
103042CD	DF02M	✦	DF	200 PIV, 1A	.31	.27	.21	.18
102971CD	DF04M	✦	DF	400 PIV, 1A	.29	.27	.25	.17
103034CD	DF06M	✦	DF	600 PIV, 1A	.35	.29	.23	.19
145429CD	KBP02M	✦	KBP	200 PIV, 1.5A	.49	.44	.39	.29
119562CD	KBP04M	✦	KBP	400 PIV, 1.5A	.49	.45	.36	.31
103018CD	W02G	✦	WOG	200 PIV, 1.5A	.32	.30	.22	.19
102980CD	W04G	✦	WOG	400 PIV, 1.5A	.49	.45	.39	.35
102998CD	W06G	✦	WOG	600 PIV, 1.5A	.45	.35	.25	.19
179469CD	W08G	✦	WOG	800 PIV, 1.5A	.69	.59	.49	.39
178124CD	W005M	✦	WOM	50 PIV, 1.5A	.49	.45	.39	.29
178132CD	W01M	✦	WOM	100 PIV, 1.5A	.32	.30	.22	.19
178141CD	W02M	✦	WOM	200 PIV, 1.5A	.29	.25	.22	.19
178175CD	W08M	✦	WOM	800 PIV, 1.5A	.39	.33	.29	.20
178183CD	BR805D	✦	BR8D	50 PIV, 2A	.55	.49	.39	.35
178204CD	BR82D	✦	BR8D	200 PIV, 2A	.85	.77	.69	.62
178247CD	BR810D	✦	BR8D	1000 PIV, 2A	.69	.59	.49	.39
179477CD	GBPC25-01	✦	GBPC	100 PIV, 25A	2.59	2.29	2.09	1.99
179485CD	GBPC25-02	✦	GBPC	200 PIV, 25A	2.79	2.29	1.79	1.49
178280CD	MB254	✦	MB35	400 PIV, 25A	2.49	2.19	1.89	1.69
178335CD	TB252	✦	TB35	200 PIV, 25A	2.10	1.85	1.69	1.50
25574CD	MDA990-3	✦	179-01	200 PIV, 30A	4.49	3.99	3.39	2.89
25591CD	MDA990-6	✦	179-01	600 PIV, 30A	4.95	4.49	3.99	3.59
178431CD	MB358	✦	MB35	800 PIV, 35A	2.95	2.74	2.47	2.22
178440CD	TB3505	✦	TB35	50 PIV, 35A	2.39	2.10	1.89	1.69
178503CD	TB3510	✦	TB35	1000 PIV, 35A	3.29	2.55	2.09	2.29

✦ Manufacturer varies

* DF/KBP/WOG/WOM/179-01 - plastic case; GBPC/TB35 - plastic case, metal base; MB35 - metal case



See page 83 & 84 for Surface Mount Transistors.

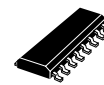

Rectifiers, Voltage Suppressors and Diodes



Diac/Triacs/Quadrac



TO-225AA

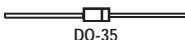

DO-35



TO-92



TO-220/AB

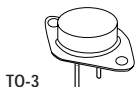

TO-3



* Prepackaged: order in increments of 10, 100 or 1000

Part No.	Prod. No.	Mfr.	Case	Description	1	10	100
140425CD	2N6071A	◆	TO-225AA	Triac, 200 VDRM, 4A	\$.49	\$.39	\$.32
160098CD	HT-32	TEC	DO-35	Diac, 27.37 V _{BO} , 2A	*	.16	.15
160178CD	L401E3	TEC	TO-92	Triac, 400 V _{DRM} , 1A	.73	.65	.58
220468CD	L4004F31	TEC	TO-220AB	Triac, 400 V _{DRM} , 4A	1.03	.92	.82
160186CD	L4004F51	TEC	TO-220AB	Triac, 400 V _{DRM} , 4A	.95	.85	.76
220450CD	L4004L3	TEC	TO-220AB	Triac, 400 V _{DRM} , 4A	1.30	1.20	1.08
31819CD	SC146B	◆	TO-220	Triac, 200 VDRM, 10A (2N6342)	1.69	1.52	1.37
31827CD	SC146M	◆	TO-220	Triac, 600 VDRM, 10A (2N6344)	1.99	1.69	1.49
160194CD	Q401E3	TEC	TO-92	Triac, 400 VDRM, 1A	.66	.61	.54
160240CD	Q4004LT	TEC	TO-220AB	Quadrac, 400 VDRM, 4A	1.25	1.12	.99
160207CD	Q4008L4	TEC	TO-220AB	Triac, 400 VDRM, 8A	1.34	1.19	1.07
220492CD	Q4008R4	TEC	TO-220AB	Triac, 400 VDRM, 8A	1.23	1.04	.99
139336CD	Q4015L5	◆	TO-220AB	Triac, 400 VDRM, 15A	1.75	1.59	1.35
160143CD	Q4025L6	TEC	TO-220AB	Triac, 400 VDRM, 25A	2.59	2.29	2.08
160215CD	Q6008L3	TEC	TO-220AB	Triac, 600 VDRM, 8A	1.49	1.33	1.19
160231CD	Q6015L5	TEC	TO-220AB	Triac, 600 VDRM, 15A	2.07	1.84	1.65
220513CD	Q6025P5	TEC	TO-3	Triac, 600 VDRM, 25A	8.29	7.39	6.59
220505CD	Q6025R6	TEC	TO-220AB	Triac, 600 VDRM, 25A	2.59	2.29	2.06
220521CD	Q6035P5	TEC	TO-3	Triac, 600 VDRM, 35A	10.99	9.89	8.89

◆ Manufacturer varies TEC = Teccor

Silicon Controlled Rectifiers (SCR)



TO-92



TO-202/AB



TO-220/AB

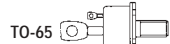

TO-65



* Prepackaged: order in increments of 10, 100 or 1000

Part No.	Prod. No.	Mfr.	Case	Description	1	10	100	1000
119802CD	2N5060	◆	TO-92	25 PRV, 0.8A	\$.35	\$.32	\$.29	\$.22
211422CD	2N5061	◆	TO-92	60 PRV, 0.8A	*	.18	.135	.114
120070CD	2N5062	◆	TO-92	100 PRV, 0.8A	.39	.35	.29	.23
211431CD	2N5064	◆	TO-92	200 PRV, 0.8A	*	.22	.17	.125
140417CD	2N6507	◆	TO-220AB	400 PRV, 25A	1.59	1.45	1.29	1.15
14859CD	C38M	◆	TO-65	600 PRV, 35A (2N3899)	6.89	6.19	5.59	5.05
14736CD	C106B1	◆	TO-202	200 PRV, 4A (2N6239)*	.65	.43	.35	.36
14752CD	C122B	◆	TO-220	200 PRV, 8A*	.99	.89	.79	.65
14761CD	C122M	◆	TO-220	600 PRV, 8A*	1.35	1.25	1.05	.69
220484CD	EC103B	TEC	TO-92	200 VDRM, 0.8A	.37	.35	.31	.31
160101CD	EC103D	TEC	TO-92	400 VRRM, 0.8A	.41	.37	.33	.33
220530CD	T106B1	TEC	TO-202AB	200 VDRM, 4A	.59	.53	.48	.48
160119CD	T106D1	TEC	TO-202AB	400 VDRM, 4A	.65	.59	.53	.53
160127CD	S401E	TEC	TO-92	400 VDRM, 1A	.58	.51	.46	.46
220548CD	S4025L	TEC	TO-220AB	400 VDRM, 25A	1.73	1.54	1.38	1.38
160135CD	S6025L	TEC	TO-220AB	600 VDRM, 25A	1.84	1.63	1.47	1.47

* Isolated ◆ Manufacturer varies TEC = Teccor

Transient Voltage Suppressors



CA: Bidirectional
A: Unidirectional



1.5KE/DO-15

* Prepackaged: order in increments of 10, 100 or 1000

Part No.	Product No.	Mfr.	Case	Min Brkdown Volt (V _{BR})	Stand-off Voltage	Pricing			
						1	10	100	1000
179557CD	1.5KE18A	GSI	1.5KE	17.1	15.3	\$.35	\$.31	\$.30	\$.29
179629CD	1.5KE43CA	GSI	1.5KE	40.9	36.8	.29	.26	.23	.21
179717CD	P6KE15CA	GSI	DO-15	14.3	12.8	.18	.17	.15	.14
179733CD	P6KE16CA	GSI	DO-15	15.2	13.3	.19	.18	.16	.15
179768CD	P6KE200CA	GSI	DO-15	190	171	.35	.29	.25	.22
179792CD	P6KE33CA	GSI	DO-15	31.4	28.2	.35	.29	.26	.23
179805CD	P6KE39A	GSI	DO-15	37.1	33.3	*	.19	.17	.14

◆ Manufacturer varies GSI = General Semiconductor

Any Diode can be special order in ammo-style tape – 1000 piece minimum

Zener Diodes



DO-35/DO-41

Prepackaged: order in increments of 10, 100 or 1000

Part No.	Prod. No.	Mfr.	Case	Description	10	100	500	1000
36290CD	1N751	◆	DO-35	5.1V, 0.5W	\$.09	\$.06	\$.05	\$.04
178765CD	1N4730A	◆	DO-41	3.9V, 1W	.09	.06	.05	.04
178773CD	1N4732A	◆	DO-41	4.7V, 1W	.09	.06	.05	.04
36089CD	1N4732A	◆	DO-41	4.7V, 1W	.09	.06	.05	.04
178781CD	1N4733A	◆	DO-41	5.1V, 1W	.09	.06	.05	.04
36097CD	1N4733A	◆	DO-41	5.1V, 1W	.09	.06	.05	.04
178790CD	1N4734A	◆	DO-41	5.6V, 1W	.09	.06	.05	.04
36118CD	1N4734A	◆	DO-41	5.6V, 1W	.09	.06	.05	.04
178802CD	1N4735A	◆	DO-41	6.2V, 1W	.09	.06	.05	.04
36126CD	1N4735A	◆	DO-41	6.2V, 1W	.09	.06	.05	.04
178811CD	1N4737A	◆	DO-41	7.5V, 1W	.09	.06	.05	.04
178829CD	1N4738A	◆	DO-41	8.2V, 1W	.09	.06	.05	.04
178837CD	1N4739A	◆	DO-41	9.1V, 1W	.09	.06	.05	.04
178845CD	1N4740A	◆	DO-41	10V, 1W	.09	.06	.05	.04
178853CD	1N4742A	◆	DO-41	12V, 1W	.09	.06	.05	.04
36169CD	1N4742A	◆	DO-41	12V, 1W	.09	.06	.05	.04
178861CD	1N4744A	◆	DO-41	15V, 1W	.09	.06	.05	.04
36185CD	1N4744A	◆	DO-41	15V, 1W	.09	.06	.05	.04
178870CD	1N4746A	◆	DO-41	18V, 1W	.09	.06	.05	.04
178888CD	1N4747A	◆	DO-41	20V, 1W	.09	.06	.05	.04
178896CD	1N4748A	◆	DO-41	22V, 1W	.09	.06	.05	.04
178909CD	1N4749A	◆	DO-41	24V, 1W	.09	.06	.05	.04
183450CD	1N4750A	◆	DO-41	27V, 1W	.09	.06	.05	.04
179004CD	1N5225B	◆	DO-35	3.0V, 0.5W	.04	.035	.03	.027
179021CD	1N5229B	◆	DO-35	4.3V, 0.5W	.04	.035	.03	.027
179039CD	1N5230B	◆	DO-35	4.7V, 0.5W	.04	.035	.03	.027
179047CD	1N5231B	◆	DO-35	5.1V, 0.5W	.04	.035	.03	.027
179055CD	1N5232B	◆	DO-35	5.6V, 0.5W	.04	.035	.03	.027
179063CD	1N5234B	◆	DO-35	6.2V, 0.5W	.04	.035	.03	.027
179071CD	1N5239B	◆	DO-35	9.1V, 0.5W	.04	.035	.03	.027
179080CD	1N5241B	◆	DO-35	11V, 0.5W	.04	.035	.03	.027
179098CD	1N5242B	◆	DO-35	12V, 0.5W	.04	.035	.03	.027
179101CD	1N5245B	◆	DO-35	15V, 0.5W	.04	.035	.03	.027
179119CD	1N5246B	◆	DO-35	16V, 0.5W	.04	.035	.03	.027
179127CD	1N5248B	◆	DO-35	18V, 0.5W	.04	.035	.03	.027
179135CD	1N5250B	◆	DO-35	20V, 0.5W	.04	.035	.03	.027



151247CD



DO-7/DO-35

* Prepackaged: order in increments of 10, 100 or 1000

Part No.	Prod. No.	Mfr.	Case	Description	1	10	100	1000
35941CD	1N270	VSH	DO-7	80 PRV (Germanium)	\$.75	\$.69	\$.59	\$.49
179207CD	1N914	VSH	DO-35	100 PRV (Switching)	*	.06	.05	.04
36311CD	1N914	◆	DO-35	75 PRV, .01A (Switching)	*	.027	.017	.009
35967CD	1N3600	◆	DO-35	50 PRV, .20A (Switching)	*	.12	.10	.08
179215CD	1N4148	VSH	DO-35	100 PRV (Switching)	*	.05	.04	.02
36038CD	1N4148	◆	DO-35	75 PRV, .01A (Switching)	*	.04	.03	.025
151247CD	1N4148T	◆	DO-35	75 PRV, .01A (Switching)	#	#	#	.02

◆ Manufacturer varies VSH = Vishay # Taped-ammo style: order in increments of 1000

See page 111 for Diode and Transistor Assortment Cabinet Kits.

Jameco's Low-Price Guarantee

We'll match the advertised price of any like product.

It's that simple!

Photo Transistors *General Purpose (6-Pin DIP)*

Single & Dual Channel

- Base lead connected • NPN output transistor
- I_{CEO} (dark) $V_{CE} = 10V$: 50nA max.
- Isolation test voltage: 7.5k V-P; 5.3k Vrms

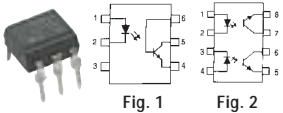

Part No.	Mfr. Cross Ref. No.	Fig.	Curr. Transfer Ratio (Min%)	Cont. Fwd. Curr. Max.	V_{CE} (Sat) Max. (V)	Pricing			
						1	10	100	500
40985CD	4N25	1	20	50mA	0.5	\$.28	\$.25	\$.23	\$.21
41005CD	4N26	1	20	50mA	($I_f = 50mA$) ($I_c = 2mA$)	.33	.30	.27	.24
144240CD	4N27	1	10	50mA		.25	.19	.17	.15
41013CD	4N28	1	10	50mA		.27	.22	.16	.11
41056CD	4N35	1	100	50mA	0.3 ($I_f = 10mA$) ($I_c = 5.0mA$)	.39	.35	.25	.16
24918CD*	MCT6	2	20	50mA	0.4 ($I_f = 16mA$) ($I_c = 0.2mA$)	.49	.45	.41	.40

* 2 independent isolators in one package, 8-pin DIP

Photo Darlington *With Base Connection (6-Pin DIP)*

- Photo Darlington transistor detector base lead connected
- BV_{CEO} $I_c = 1mA$: 30V min.
- Current transfer ratio $I_f = 10mA$ $V_{CE} = 10V$
- Isolation test voltage: 7.5k V-P; 5.3k Vrms

Part No.	Mfr. Cross Ref. No.	Curr. Transfer Ratio (Min%)	Cont. Fwd. Curr. Max.	V_{CE} (Sat) Max. (V)	Pricing			
					1	10	100	500
41021CD	4N32	500	80mA	1.0 ($I_f = 8mA$) ($I_c = 2mA$)	\$.29	\$.25	\$.22	\$.19
41030CD	4N33	500	80mA		.29	.25	.22	.19

Schmitt Trigger *Single Channel (6-Pin DIP)*

- Microprocessor compatible
- Isolation test voltage: 7.5k V-P; 5.3k Vrms

Part No.	Mfr. Cross Ref. No.	Threshold Current		Output Volt (low)	Pricing			
		$R_L = 270\Omega$ $V_{CC} = 5V$	$R_L = 270\Omega$ $V_{CC} = 5V$		1	10	100	500
113988CD	H11L1	1.6mA	0.3mA	0.4	\$.89	\$.79	\$.69	\$.59

AC Input Isolator *Single Channel (6-Pin DIP)*

- Isolation test voltage: 7.5k V-P; 5.3k Vrms
- V_f (LED) $I_f = 10mA$: 1.5V max.
- BV_{CEO} $I_c = 1mA$: 30V min.

Part No.	Mfr. Cross Ref. No.	Curr. Transfer Ratio (Min%)	Cont. Fwd. Curr. Max.	V_{CE} (Sat) $I_f = 10mA$ $I_c = 0.5mA$	Pricing			
					1	10	100	500
18825CD	H11AA1	20	100mA	0.4V (max)	\$.39	\$.35	\$.29	\$.28

Transistor Slotted Interrupter *Single Channel (4-Pin Slot)*

- With mounting tabs
- $V_f = 1.7V$ max. @ 60mA

Part No.	Mfr. Cross Ref. No.	BV_{CEO} $I_c = 1mA$	BV_{CEO} $I_e = 100\mu A$	I_{CEO} (max) $V_{CE} = 25V$ $I_h = 0$	Pricing			
					1	10	100	500
114091CD	H21A1	30V min	6.0Vmin	100nA	\$.83	\$.75	\$.61	\$.59

FET Coupler *Single Channel (6-Pin DIP)*

- Optically coupled pair with symmetrical bilateral silicon detector
- On state resistance $I_f = 16mA$; $I_{46} = 100\mu A$; 200 Ω max.
- Isolation test voltage: 7.5k V-P; 5.3k Vrms

Part No.	Mfr. Cross Ref. No.	Output Brkdown Volt. $I_{46} = 10\mu A$	Cont. Fwd. Curr. Max.	Off State Curr. $I_{46} = 15V$	Pricing			
					1	10	100	500
113996CD	H11F1	30V (min)	60mA	50nA (max)	\$.219	\$.175	\$.157	\$.141

Zero Crossing Triac Couplers *Single Channel (6-Pin DIP)*

- Performs the function of a zero voltage crossing bilateral triac driver
- Isolation test voltage: 7.5k V-P; 5.3k Vrms

Part No.	Mfr. Cross Ref. No.	Input Trig. Curr. $V_{TM} = 3V$ (Max)	Cont. Fwd. Curr. Max.	Peak Block Volt. Min (V)	Pricing			
					1	10	100	500
26294CD	MOC3031	15mA	50mA	250	\$.19	\$.109	\$.85	\$.65
113953CD	MOC3032	10mA	50mA	250	.95	.84	.76	.68
113961CD	MOC3042	10mA	50mA	400	.89	.81	.72	.65
133874CD	MOC3063	5mA	50mA	600	1.25	1.12	.99	.71

Transistor Couplers *Single Channel (8-Pin DIP)*

- Isolation voltage: 2.5k Vrms min.
- 42471CD: High speed
- Propagation delay time t_{PHL} : 0.8 μs max.
- 113911CD: Very high speed logic
- Propagation delay time t_{PHL} : 75ns max.
- LSTTL/TTL compatible
- 42489CD: High speed, high gain
- Propagation delay time t_{PHL} : 10 μs max.
- 113929CD: High speed, high gain
- Propagation delay time t_{PHL} : 25 μs max.

SALE

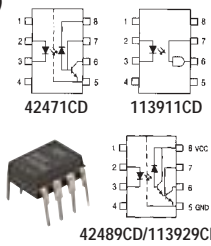

Part No.	Mfr. Cross Ref. No.	Curr. Transfer Ratio (Min%)	Specified Input Curr.	Typical Data Rate (NRZ)	Pricing			
					1	10	100	500
42471CD	6N136	19	16mA	1Mbps/s	\$.79	\$.69	\$.55	\$.39
113911CD	6N137	700	5mA	10Mbps/s	.86	.72	.58	.39
42489CD	6N138	300	1.6mA	300kbits/s	.45	.41	.35	.31
113929CD	6N139	400	0.5mA	300kbits/s	.79	.69	.59	.43

Triac Couplers *Single Channel (6-Pin DIP)*

- Infrared emitter and light activated silicon bilateral switch
- Isolation test voltage: 7.5k V-P; 5.3k Vrms

Part No.	Mfr. Cross Ref. No.	Input Trig. Curr. $V_D = 3V$ (Max)	Cont. Fwd. Curr. Max.	Peak Block Volt. Min (V)	Pricing			
					1	10	100	500
26278CD	MOC3010	15mA	60mA	250	\$.49	\$.45	\$.39	\$.35
95020CD	MOC3011	10mA	60mA	250	.55	.49	.45	.40
95038CD	MOC3021	15mA	60mA	400	.75	.69	.55	.45

ISOCOM

Photo Transistor *Low Input (4-Pin DIP)*

- Isolation test voltage: 7.5k V-P; 5.3k Vrms

Part No.	Product No.	BV_{CEO} $I_c = 1mA$	Curr. Trans. Ratio Min (%) $V_{CE} = 0.4V$ $I_f = 0.5/1mA$	VBR $I_r = 10\mu A$	Pricing			
					1	10	100	500
138069CD	ISP817-3	70V	70/100	10V	\$.99	\$.89	\$.79	\$.65

ISOCOM

Transistor/Detector *Quad Channel (16-Pin DIP)*

- High Isolation voltage/CTR/sensitivity
- 4 independent isolators in one package
- Isolation test voltage: 7.5k V-P; 5.3k Vrms

Part No.	Product No.	Curr. Transfer Ratio (Min%) $I_f = 10mA$ $V_{CE} = 10V$	Cont. Fwd. Curr. Max.	Pricing			
				1	10	100	500
114083CD	ISQ203	225-450	50mA	\$.295	\$.265	\$.239	\$.215

ISOCOM

Photo Darlington & Transistor/Detector *(16-Pin DIP)*

- Isolation test voltage: 7.5k V-P; 5.3k Vrms
- NPN transistor
- 1.17Vf @ 10mA (typical)
- Continuous forward current (max.): 50mA
- 160362CD: Photo darlington
- 160338CD: Photo transistor/detector

SALE

Part No.	Product No.	Curr. Transfer Ratio (Min%)	BV_{CEO} ($I_c = 1mA$)	V_{CE} (Sat) $I_f = 10mA$; $I_c = 2\mu A$	Pricing			
					1	10	100	500
160362CD	PS2502-4	200	40V	1.0V max.	\$.199	\$.178	\$.155	\$.139
160338CD	PS2501-4	80-6000	80V	0.3V max.	1.35	1.12	.95	.85

Module Optical Switch

- Input diode: forward voltage (V_f) – 1.60V max. ($I_f = 20mA$); reverse current (I_r) – 10 μA ($V_R = 5V$) • Type N package
- Collector dark current (I_{CEO}) – 100nA ($V_{CE} = 10V$)
- C-E saturation voltage (V_{CE}) (sat): 0.4V max. ($I_c = 0.5mA$; $I_f = 20mA$)

Part No.	Product No.	Dimensions	1	10	50
196058CD	ITR-8105	0.10"W x 0.22"D x 0.29"H	\$1.95	\$1.75	\$1.59

OPTEK

Slotted Optical Switch

- Input diode: forward voltage (V_f) – 1.60V ($I_f = 10mA$); reverse current (I_r) – 100 μA ($V_R = 3.0V$) • Type N package
- Output phototransistor: breakdown voltage (V_{BR} CEO) = 30V min.; collector-emitter dark current (I_{CEO}) – 100nA ($V_{CE} = 5V$)
- Coupled: saturation voltage (V_{SAT}) – 0.40V ($I_f = 10mA$; $I_c = 100\mu A$) gap unblocked

SALE

Part No.	Product No.	Dimensions	1	10	50
189481CD	OPB660N	0.13"W x 0.26"D x 0.35"H	\$1.99	\$1.79	\$1.59

Crystals

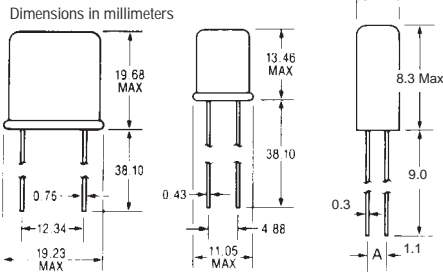

HC33/U Case

HC49/U (HC18/U) Case

TF Case

- Frequency calibration tolerance: ± 50 ppm @ 25°C
- Operating temperature: -10°C to +60°C
- Drive level: 4.0 mW maximum
- Frequency stability tolerance: ± 50 ppm from -10°C to +60°C
- Shunt capacitance: 7pF maximum



Application Reference (4-14MHz) (Parallel Resonance)

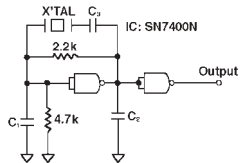

- C1: 150-470 pF
- C2: 220-820 pF
- C3: Match crystal impedance

HC33/U Case

Part No.	Mfr. Cross Ref. No.	Frequency (MHz)	Impedance	Microprocessor	Pricing			
					1	10	100	1000
14349CD	CY1	1.0	13pF	MC6800/6808/6809E/6500 series	\$4.95	\$4.49	\$3.95	\$3.49

SALE

HC49/U (HC18/U) Case

Part No.	Mfr. Cross Ref. No.	Frequency (MHz)	Impedance	Microprocessor	Pricing			
					1	10	100	1000
102613CD	CY1.843	1.8432	18pF	MC14411/MC6802	\$.99	\$.72	\$.51	\$.39
102621CD	CY2.0	2.0	Series	2650/F-8	1.49	1.25	.99	.75
101274CD	CY2.457	2.4576	32pF	CDP1702/1802C/1804/1804C	.99	.89	.79	.69
14525CD	CY3.27	3.2768	18pF	IM6100C/CDP1802/CDP1804	.99	.89	.79	.69
14533CD	CY3.57	3.579545	18pF	MC6801,2,3/MM5369	.59	.54	.42	.39
14568CD	CY3.68	3.6864	18pF	8748/8035-8	.89	.79	.69	.59
14592CD	CY4	4.0	20pF	MCS-40/MC6802,8,9/CDP1802	.59	.54	.41	.39
14621CD	CY4.91	4.9152	Series	CDP1802C/1804/1804C	.89	.79	.69	.59
14681CD	CY6	6.0	18pF	MCS-48/IM8048	.79	.70	.59	.40
14699CD	CY6.14	6.144	30pF	MCS-85/8085	.79	.69	.55	.41
14710CD	CY7.37	7.3728	30pF	8051/8031	.89	.80	.65	.45
14728CD	CY8	8.0	Series	IM6100A/MC68B09	.74	.67	.60	.54
14381CD	CY10	10.0	Series	MCS-85/8085A-2	.79	.69	.59	.49
120061CD	CY11.05	11.0592	Series	General purpose	.89	.79	.69	.59
14402CD	CY12	12.0	Series	MCS-86/8086/8284/8202	.89	.75	.65	.39
14453CD	CY16	16.0	Series	8080/8224/general purpose	.62	.56	.45	.35
14517CD	CY20	20.0	Series	MCS-80/8080A/8224	.79	.69	.59	.39

TF Case

14584CD	CY32.76	32.768kHz	10.5pF	Tuning fork	\$.89	\$.79	\$.69	\$.59
---------	---------	-----------	--------	-------------	--------	--------	--------	--------

Low Profile Crystals

- Frequency range: 3.5 to 70.0MHz
- Operating temp.: -10°C to +60°C
- Drive level: 0.5mW (fundamental frequency)
- Aging: ± 5 ppm/year maximum
- Frequency stability tolerance: ± 50 ppm

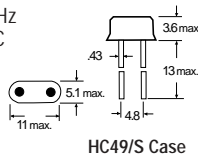

HC49/S Case

HC49/S Case (Low Profile)

Part No.	Mfr. Cross Ref. No.	Frequency (MHz)	Imped.	Max. Resist.	Microprocessor	Pricing			
						1	10	100	1000
137816CD	CY3.57LP	3.579545	17pF	150Ω	MC6801, 2, 3/MM5369	\$.95	\$.81	\$.65	\$.59
137832CD	CY4LP	4.000	17pF	120Ω	MCS-40/MC6802, 8, 9/CDP1802	.99	.89	.79	.69
137859CD	CY8LP	8.000	Series	60Ω	IM6100A/MC68B09	.75	.67	.59	.53
137875CD	CY11.05LP	11.0592	Series	50Ω	General purpose	.72	.65	.53	.42
137891CD	CY16LP	16.000	Series	40Ω	8080/8224/general purpose	.69	.62	.56	.51

TTL Crystal Oscillators

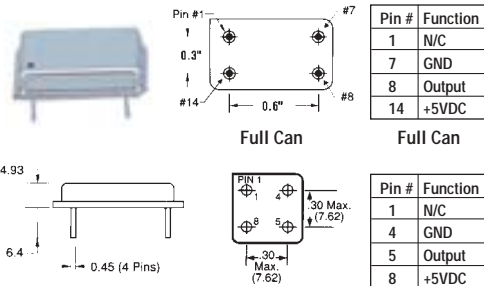

Full Can

Full Can

Half Can

Half Can

Specifications:

- Input voltage: +5VDC ± 0.5 VDC
- OSC series oscillators fit into a 14-pin DIP socket P/N 133006CD, below
- Frequency stability ± 100 ppm
- Operating temperature: 0°C to 70°C



102779CD

Part No.	Mfr. Cross Ref. No.	Frequency (MHz)	Size	Max Input Current	Rise Fall Time	Input Current	Pricing			
							1	10	100	1000
27861CD	OSC1	1.0	Full	7mA	15ns	45mA	\$2.75	\$2.45	\$1.59	\$1.39
27879CD	OSC1.84	1.8432	Full	7mA	15ns	45mA	2.39	2.15	1.75	1.29
27924CD	OSC2	2.0	Full	7mA	15ns	30mA	1.99	1.79	1.59	1.39
27967CD	OSC4	4.0	Full	7mA	10ns	50mA	1.99	1.79	1.59	1.39
27991CD	OSC8	8.0	Full	15mA	15ns	30mA	1.99	1.79	1.59	1.39
27887CD	OSC10	10.0	Full	15mA	10ns	20mA	1.99	1.79	1.59	1.39
102779CD	OSC10H	10.0	Half	45mA	6ns	30mA	1.19	1.07	.96	.86
144207CD	OSC11.05	11.059	Full	50mA	10ns	30mA	1.99	1.79	1.59	1.39
27895CD	OSC12	12.0	Full	15mA	10ns	50mA	1.99	1.65	1.19	.84
108652CD	OSC14.31	14.31818	Full	15mA	10ns	50mA	1.99	1.79	1.59	1.39
27908CD	OSC16	16.0	Full	15mA	10ns	50mA	1.59	1.45	1.15	.85
27932CD	OSC20	20.0	Full	17mA	10ns	20mA	1.79	1.59	1.45	1.29
27941CD	OSC32	32.0	Full	18mA	7ns	15mA	1.59	1.45	1.15	.85
76822CD	OSC33	33.0	Full	18mA	6ns	15mA	1.99	1.79	1.60	1.45
153226CD	OSC40	40.0	Full	18mA	6ns	15mA	1.79	1.59	1.45	1.29
76831CD	OSC50	50.0	Full	25mA	6ns	25mA	1.99	1.79	1.59	1.39
76857CD	OSC100	100.0	Full	25mA	3ns	90mA	2.49	2.25	1.95	1.75

14-Pin Crystal Oscillator Socket

- Can be PCB mounted without the modifications that would be needed with DIP-IC sockets
- Low profile solder tail; machine tooled on 4 pins
- Good for prototyping and PCB mounting



Part No.	Description	1	10	100	1000
133006CD	Oscillator socket	\$.55	\$.46	\$.34	\$.31

Typical Crystal Oscillator Design

An oscillator is an amplifier with a feedback loop from output to input. Barkhausen criteria states that for oscillation to occur, the product of the gains around a loop must be equal to or greater than unity and that the sum of the phase shifts around the loop must be a multiple of 360°.

These parameters will determine the crystal specifications:

- On what crystal frequency do you wish to operate?
- How much can the frequency be off at room temperature (25°C)?
- At what temperature range will the crystal operate?
- How much can the crystal change frequency over the temperature range?
- Will the crystal operate at a series or parallel resonant?
- If operated at parallel, what is the parallel capacitance in picofarads (pF)?
- Is pullability important? • What holder type or can size do you require?

Call for pricing on large quantities – we carry major manufacturers. We will special order any IC – 100 Piece Minimum

4000 Series

Part No.	Cross Ref.	Pins	Description	SOIC		
				1	10	100
197261CD	CD4001M	14	Quad 2-input NOR gate	\$.29	\$.24	\$.19
197270CD	CD4011M	14	Quad 2-input NAND gate	.29	.24	.19
197288CD	CD4013M	14	Dual D flip-flop with set/reset	.29	.24	.19
197296CD	CD4017M	16	Decade counter/divider	.49	.39	.29
197309CD	CD4020M	16	14-stage binary/ripple counter	.49	.39	.29
197317CD	CD4027M	16	Dual JK master-slave flip-flop	.39	.35	.29
197325CD	CD4029M	16	Pre-settable up/down counter	.49	.44	.39
197333CD	CD4040M	16	12-stage binary/ripple counter	.29	.25	.22
197341CD	CD4049M	16	Hex/buffer/converter (inverting)	.35	.29	.24
197350CD	CD4050M	16	Hex/buffer/converter (N-inverting)	.29	.25	.19
197368CD	CD4051M	16	Single 8-channel multi/demultiplexer	.39	.35	.29
197376CD	CD4066M	14	Quad bilateral switch	.29	.24	.19
197384CD	CD4069M	14	Hex inverter (74C04)	.29	.24	.19
197392CD	CD4071M	14	Quad 2-input OR gate	.29	.24	.19
197405CD	CD4081M	14	Quad 2-input AND gate	.29	.24	.19
197413CD	CD4093M	14	Quad 2-input NAND Schmitt trigger	.29	.24	.19
197421CD	CD4511M	16	BCD to 7-seg. latch/decoder/driver	.49	.45	.39
197430CD	CD4538M	16	Dual precision monostable multivibrator	.69	.48	.43
197448CD	CD4584M	14	Hex Schmitt trigger (74C14) 40106	.29	.24	.19

74HC Series

Part No.	Cross Ref.	Pins	Description	SOIC		
				1	10	100
197106CD	74HC00M	14	Quad 2-input NAND gate	\$.32	\$.26	\$.23
197122CD	74HC04M	14	Hex inverter (buffered)	.29	.24	.19
197131CD	74HC08M	14	Quad 2-input AND gate	.32	.26	.23
197149CD	74HC14M	14	Hex inverter Schmitt trigger	.32	.26	.23
197157CD	74HC32M	14	Quad 2-input OR gate	.29	.26	.23
197165CD	74HC74M	14	Dual D flip-flop	.38	.29	.26
197173CD	74HC138M	14	3-to-8 decoder/demultiplexer	.35	.29	.25
197181CD	74HC164M	14	8-bit serial shift register	.39	.35	.29
197190CD	74HC165M	16	Parallel load 8-bit serial shift register	.35	.31	.26
197202CD	74HC244M	20	Octal driver tri-state	.49	.41	.31
197211CD	74HC245M	20	Octal transceiver tri-state	.49	.41	.31
197229CD	74HC373M	20	Octal D-type flip-flop tri-state	.49	.39	.29
197237CD	74HC374M	20	Octal D-type flip-flop edge-trig tri-state	.49	.39	.29
197245CD	74HC573M	20	Octal D-type flip-flop tri-state	.49	.39	.29
197253CD	74HC574M	20	Octal D-type flip-flop tri-state	.49	.39	.29

74LS Series

Part No.	Cross Ref.	Pins	Description	SOIC		
				1	10	100
198361CD	74LS00M	14	Quad 2-input NAND gate	\$.29	\$.24	\$.19
198379CD	74LS02M	14	Quad 2-input NOR gate	.29	.24	.19
198387CD	74LS04M	14	Hex inverter	.29	.24	.19
198395CD	74LS05M	14	Hex inverter (O.C.)	.29	.24	.19
198408CD	74LS07M	14	Hex buffer/driver (O.C. hi-voltage)	.59	.49	.45
198416CD	74LS08M	14	Quad 2-input AND gate	.29	.24	.19
198424CD	74LS10M	14	Triple 3-input NAND gate	.29	.24	.19
198432CD	74LS11M	14	Triple 3-input AND gate	.29	.24	.19
198441CD	74LS14M	14	Hex inverter schmitt trigger	.29	.24	.19
198459CD	74LS20M	14	Dual 4-input NAND gate	.29	.24	.19
198467CD	74LS30M	14	8-input NAND gate	.29	.24	.19
198475CD	74LS32M	14	Quad 2-input OR gate	.29	.24	.19
198491CD	74LS74M	14	Dual D flip-flop	.29	.24	.19
198504CD	74LS75M	16	4-bit bi-stable latch	.39	.35	.29
198512CD	74LS85M	16	4-bit magnitude comparator	.39	.35	.29
198521CD	74LS86M	14	Quad EXCLUSIVE-OR gate	.39	.35	.29
198539CD	74LS90M	14	Decade counter	.49	.39	.29
198547CD	74LS93M	14	4-bit binary counter	.99	.89	.75
198555CD	74LS123M	16	Dual mono. multivibrator with clear	.49	.39	.29
198563CD	74LS138M	16	3 to 8 decoder/demultiplexer	.39	.35	.29
198571CD	74LS151M	16	8-input multiplexer	.39	.35	.29
198580CD	74LS157M	16	Quad 2/1 data selector	.39	.35	.29
198598CD	74LS193M	16	Binary up/down counter with clear	.49	.45	.39
198619CD	74LS240M	20	Octal invert. line driver tri-state	.49	.45	.39
198627CD	74LS244M	20	Octal driver tri-state	.39	.34	.29
198635CD	74LS245M	20	Octal bus transceiver tri-state	.39	.34	.29
198643CD	74LS273M	20	Octal D-type flip-flop with clear	.39	.34	.29
198651CD	74LS373M	20	Octal D flip-flop tri-state	.39	.34	.29
198660CD	74LS374M	20	Octal D F/F edge-trig tri-state	.39	.34	.29

Linear Series

Part No.	Cross Ref.	Pins	Description	SOIC		
				1	10	100
193480CD	LM34DM	8	Prec. F temp. sensor (-55°F to 300°F)	\$1.49	\$1.35	\$1.10
193498CD	LM35DM	8	Prec. C temp. sensor (-55°C to 150°C)	1.49	1.35	1.10
193501CD	TL072CD	8	Low noise JFET dual op amp.	.39	.29	.25
193519CD	TL074CD	8	Low noise JFET quad op amp.	.49	.39	.35
193527CD	TL082CD	8	JFET input dual op amp.	.37	.31	.29
193535CD	TL084CD	14	JFET input quad op amp.	.49	.45	.39
193543CD	LM311D	8	Voltage comparator	.29	.21	.19
86721CD	LM324D	14	Low power quad op amp.	.29	.21	.18
193560CD	LM335M	8	Precision temperature sensor	.99	.89	.79
193578CD	LM336M-2.5	8	Precision 2.5V shunt regulator diode	.69	.59	.49
193594CD	LM339M	14	Low pwr. low offset volt quad comparator	.29	.24	.19
193607CD	LF356M	8	JFET input op amp. (wide band)	.59	.54	.49
193615CD	LM358D	8	Low power dual op amp.	.29	.19	.16
193623CD	LM386M-1	8	Low volt. audio power amp. 250mW/12V	.29	.27	.25
193631CD	LM393D	8	Low power offset voltage dual comparator	.29	.24	.19
193640CD	LF412CD	8	Low offset drift JFET input dual op amp.	.99	.89	.69
86799CD	LM555CM	8	Timer (NE555D)	.29	.25	.22
193658CD	LM556CM	14	Dual 555 timer	.39	.35	.29
193666CD	LM567CM	8	Tone decoder	.39	.35	.29
193682CD	LM1458M	8	Dual op amp.	.29	.24	.18
193691CD	LM1488D	14	Quad line driver (RS-232)	.29	.25	.22
193703CD	LM1489D	14	Quad line receiver (RS-232)	.29	.25	.22
193826CD	ULN2003AD	16	Hi-volt/curr. darl. transistor array	.39	.35	.29
193738CD	NE5532D	16	Dual low noise op amp.	.45	.39	.35
193746CD	NE5534D	8	Low noise op amp.	.32	.29	.26

MAX232

Part No.	Cross Ref.	Pins	Description	SOIC		
				1	10	100
106147CD	MAX232CWE	16	+5V pwred, dual RS-232 trans./receiver	\$1.95	\$1.75	\$1.59

Voltage Regulators

Part No.	Cross Ref.	Pins	Description	SOIC		
				1	10	100
193551CD	LM317LM	8	100mA adj. pos. regulator (1.2V to 37V)	\$.32	\$.28	\$.21
193586CD	LM337LM	8	1.5A adj. neg. regulator (-1.2V to -37V)	.79	.69	.59
214050CD	LM723CD	14	High precision voltage regulator	.34	.32	.30
193754CD	78L05ACM	8	5V 100mA pos. voltage regulator	.29	.25	.22
193762CD	78L06ACM	8	6.2V 100mA pos. voltage regulator	.29	.25	.22
193771CD	78L12ACM	8	12V 100mA pos. voltage regulator	.29	.25	.22
193789CD	78L15ACM	8	15V 100mA pos. voltage regulator	.25	.22	.19
193797CD	79L05ACM	8	-5V 100mA neg. voltage regulator	.35	.29	.25
193800CD	79L12ACM	8	-12V 100mA neg. voltage regulator	.35	.29	.25
193818CD	79L15ACM	8	-15V 100mA neg. voltage regulator	.29	.25	.22

Transistors

Part No.	Product No. →	Case	Desc.	V _{ceo}	Min. (h _{FE} @ I _c)	SOT-23				SOIC-16			
						1	10	100	1000	1	10	100	1000
214834CD	MMBTA05	SOT-23	NPN	60	—	*	\$.067	\$.045	\$.03				
214842CD	MMBTA06	SOT-23	NPN	80	100 @ .01A	...	*	.057	.048	.038			
214851CD	MMBTA13	SOT-23	NPN	30	5k @ .01A	...	*	.057	.039	.026			
214869CD	MMBTA14	SOT-23	NPN	30	10k @ .01A	...	*	.059	.039	.024			
214885CD	MMBTA42	SOT-23	NPN	300	40 @ .01A	...	*	.065	.057	.047			
214906CD	MMBTA55	SOT-23	PNP	60	100 @ .01A	...	*	.056	.038	.024			
214914CD	MMBTA56	SOT-23	PNP	80	100 @ .01A	...	*	.085	.058	.04			
214922CD	MMBTA63	SOT-23	PNP	30	5k @ .01A	...	*	.056	.038	.025			
214931CD	MMBTA64	SOT-23	PNP	30	10k @ .01A	...	*	.056	.038	.025			
214957CD	MMBTA92	SOT-23	PNP	300	40 @ .01A	...	*	.113	.074	.049			
213920CD	MMBT918	SOT-23	NPN	15	20 @ .003A	...	*	.043	.029	.018			
94941CD	MMBT2222	SOT-23	NPN	30	100 @ .15A22	.19	.15	.12			
213938CD	MMBT2222A	SOT-23	NPN	40	100 @ .15A	...	*	.054	.045	.029			
213997CD	MMBQ2222A	SOIC-16	NPN	40	100 @ .15A87	.81	.75	.57			
214658CD	MMBT2369	SOT-23	PNP	25	60 @ .05A	...	*	.04	.027	.017			
213946CD	MMBT2369A	SOT-23	NPN	15	40 @ .01A	...	*	.039	.027	.017			
94959CD	MMBT2907	SOT-23	PNP	40	100 @ .15A22	.19	.15	.12			
213954CD	MMBT2907A	SOT-23	PNP	60	100 @ .01A	...	*	.038	.03	.02			
214009CD	MMPQ2907A	SOIC-16	PNP	60	100 @ .01A99	.92	.81	.56			

* Prepackaged: order in increments of 10, 100 or 1000
 → Manufacturer varies

Transistors (Continued)

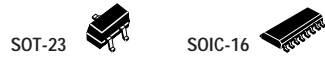

* Prepackaged: order in increments of 10, 100 or 1000

Part No.	Product No. ♦	Case	Desc.	Vceo	Min. (I _{FE} @ Ic)	1	10	100	1000
94967CD	MMBT3904	SOT-23	NPN	40	100 @ .01A*	\$.045	\$.035	\$.03
94975CD	MMBT3906	SOT-23	PNP	40	100 @ .01A*	\$.045	\$.035	\$.03
214017CD	MMPQ3906	SOIC-16	PNP	40	75 @ .01A89	.79	.71	.53
214674CD	MMBT4124	SOT-23	NPN	25	60 @ .05A*	\$.055	\$.037	\$.024
214682CD	MMBT4126	SOT-23	PNP	25	60 @ .05A*	\$.053	\$.037	\$.024
214703CD	MMBT4401	SOT-23	NPN	40	80 @ .01A*	\$.057	\$.038	\$.029
214720CD	MMBT4403	SOT-23	PNP	40	60 @ .001A*	\$.076	\$.049	\$.035
213962CD	MMBT5087	SOT-23	PNP	50	250 @ .01A*	\$.049	\$.036	\$.027
213971CD	MMBT5088	SOT-23	NPN	30	300 @ .01A*	\$.04	\$.027	\$.017
214746CD	MMBT5089	SOT-23	NPN	25	400 @ .01A*	\$.039	\$.027	\$.017
214754CD	MMBT5401	SOT-23	PNP	150	40 @ .001A*	\$.053	\$.039	\$.029
214762CD	MMBT5550	SOT-23	NPN	140	60 @ .01A*	\$.049	\$.034	\$.022
214771CD	MMBT5551	SOT-23	NPN	140	80 @ .01A*	\$.063	\$.045	\$.039
213989CD	MMBT6427	SOT-23	NPN	40	10k @ .01A*	\$.063	\$.057	\$.028
214789CD	MMBT6428	SOT-23	NPN	50	250 @ .01A*	\$.04	\$.027	\$.017
214025CD	MMPQ6700	SOIC-16	PNP/PNP	40	70 @ .01A73	.70	.65	.51

♦ Manufacturer varies

Diode

SALE



Prepackaged: order in increments of 100 or 1000

Part No.	Mfr. Cross Ref. No.	Description	100	1000
94908CD	1N4148SM	75 PRV @ 50µA, 10mA	\$.03	\$.025

Vacuum Tweezers

Pick & place small parts of all kinds: glass slides, coins, optics, SMDs, film, etc.

- Size: 2.9"L x 0.6"W • One-year warranty

Includes: 5 pads sizes 0.14" to 0.4"; 5 straight tips and 2 pieces 45° angle tips

Part No.	Description	1	10
88268CD	Vacuum pick & place kit

4-Piece Conductive SMD Tweezer Set

- 4 types of tweezers: fine point, flat head for 4mm SMD chip device, flat head for 8mm SMD chip device, sharp angled tip • Each is 4.5" long

Part No.	Description	1	10	25
172638CD	4-piece conductive SMD tweezer set

CHIPQUIK SMD 2000 Removal System

Complete Solder/Desolder Rework Kit

- Removal alloy, solder paste, 3' solder, paste flux, liquid flux remover/cleaner, handi vac, 2 acid brushes, precision tweezers, six 4" x 4" cleaning wipes, 10 swabs, 6 alcohol pads, SMD removal/clean up instructions, stainless steel probe kit & 5' solder wick

Part No.	Description	1	10
208055CD	SMD 2000 removal system

PLCC Surface Mount and DIP IC Extractors

- Size: 4.0"L x 2.0"W (both)

Part No.	Product No.	Description	1	10	100
16766CD	HT103B	PLCC IC extractor
16838CD	HT103A	DIP IC extractor

CHIPQUIK SMD Removal Kit

- Quick and easy to use
- Potential damage to printed circuit boards is eliminated
- 2.5" of CHIPQUIK® material removes 1250-1500 SMD pins
- Uses simple equipment and materials for application & clean-up

Part No.	Description	1	10
141305CD	SMD removal kit

Surface Mount Proto Boards

Prototyping SMT circuit boards has been tedious and time-consuming because surface mount devices are so small. Now there is an easy, cost-effective and versatile Snap-Apart solution from Bellin Dynamic Systems.

- Quality silk-screened and solder-masked boards
- V-groove scoring between elements for smooth straight edges
- Compatible with .100" single or dual row male headers (see pg 128)
- Size: 7.6"L x 5.0"W • Board thickness: 0.031"
- See our website (www.Jameco.com) for additional specifications

BELLIN DYNAMIC SYSTEMS, INC.

Small SMT

Part No.	Prod. No.	Description	1	10
215491CD	B502	160 SMT pattern, SOT/SOIC/TSOP/MSOP/DPAK & more
227344CD	B513	300 SMT pattern, SC90, SOT23-6, 323-6, TSOP, MSOP8, 10+

SOIC

215520CD	B505	60 SOIC SMT pattern, SOIC 8, 14, 16, 24, 32, 40 & more
227310CD	B510	140 SMT pattern, SOIC 8 to DIP .300" width
227328CD	B511	63 SMT pattern, SOIC nrw/wd 8, 14, 16, 18, 20 to DIP .300"
227352CD	B514	72 SMT pattern, SOIC narrow 8, 14, 16, 18, 20 to DIP .300"
227361CD	B515	30 SMT pattern, SOIC 24, 28, 32 to DIP .600" width

Fine Pitch Dual Row

215503CD	B503	34 SMT pattern, SOIC/QSOP/TSOP/MSOP/TSSOP & more
227281CD	B507	40 SMT pattern, SSOP/TSSOP 16, 20, 32, 40 & more

Quad

215511CD	B504	25 SMT pattern, QFP32, 44, 48, 52, 54, 64, 70, 80, 100 PLCC18, 20, 28, 32, 44
227336CD	B512	24 SMT pattern, PLCC18, 20, 22, 28, 32, 44, 52, 68, 84 & 100

PCB Connector (0.062" thick through-hole)

227272CD	B506	45 SMT pattern, USB A, B/1394/RJ11, 12, 45/DB9 PCB conn.
----------	------	----------------------------------------------------------	-------	-------

PitchStick™

B508

227299CD	B508	20 SMT pattern, 48 inline pads, metric/rare pitches
227301CD	B509	20 SMT pattern, 48 inline pads, 50 & 25 mil pitches



Surfboards®

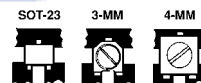

Ideal for Prototyping!

Mini Breadboards for Surface Mount Devices

6000/6100 Series for Discrete Devices

- Universal large foil pattern areas accept a wide range of device footprints or can be modified to accept new footprints • 0.1" pin spacing • Height: 0.5"

Part No.	Product No.	Pins	Width	1	10
207423CD	6103	3	0.3"
207407CD	6008	8	0.8"
207431CD	6109	9	0.9"
207415CD	6010	10	1.0"

9000 Series for ICs

- Adapt SMD to thru-hole
- Size: 1.20"W x 0.65"H
- 207378CD/207394CD: 0.1" pin spacing

Part No.	Product No.	1	10
207360CD	9081 (For 8-pin SOIC)
207378CD	9082 (For 8-pin SOIC)
207386CD	9161 (For 14/16-pin SOIC)
207394CD	9163 (For 14/16-pin SOIC)



Application Specific Adapters

33000 series SURFBOARDS® convert SMD component footprints to SIP format. Compatible with conventional and solderless breadboards & sockets (.100" center pins).

Part No.	Product No.	Accepted Devices	Pins	1	10
207589CD	33205	SOT-23-5/SC59-5	5
207597CD	33206	SOT-23-6/SOT-23-L/SC-59-6/TSOP-6	6

Surface Mount Capacitors and Resistors



193009CD Tape and Reel



193009CD

Aluminum Electrolytic Capacitors

Operating temperature range	-40°C to +85°C
Leakage Current (20°C) after 2 minutes	1 ≤ .01CV or 3μA

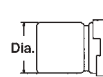

Side View



Bottom View

* Prepackaged: order in increments of 10, 100 or 1000

* Prepackaged: order in increments of 10, 100 or 1000

Part No.	Mfr. Cross Ref. No.†	Value (μF)	Voltage	Dia. (mm)	Pricing			
					1	10	100	500
193228CD	SE1/50	1	50	4.0	* .25	\$.19	\$.16	
193236CD	SE2.2/50	2.2	50	4.0	.39	.35	.29	.25
193244CD	SE3.3/50	3.3	50	4.0	* .22	.17	.14	
193076CD	SE4.7/25	4.7	25	4.0	* .29	.24	.16	
193252CD	SE4.7/50	4.7	50	5.0	* .16	.14	.12	
192997CD	SE10/16	10	16	4.0	* .29	.26	.22	
193084CD	SE10/25	10	25	5.0	* .29	.24	.16	
193164CD	SE10/35	10	35	5.0	* .26	.22	.19	
193261CD	SE10/50	10	50	6.3	* .19	.16	.14	
192891CD	SE22/6.3	22	6.3	4.0	* .29	.24	.16	
193009CD	SE22/16	22	16	5.0	* .29	.24	.16	
193092CD	SE22/25	22	25	6.3	* .39	.29	.25	
193172CD	SE22/35	22	35	6.3	* .19	.16	.14	
193279CD	SE22/50	22	50	6.3	* .26	.22	.19	
193017CD	SE33/16	33	16	5.0	* .29	.25	.20	
193105CD	SE33/25	33	25	6.3	* .22	.19	.17	
193181CD	SE33/35	33	35	8.0	* .29	.24	.21	
193287CD	SE33/50	33	50	8.0	* .30	.25	.22	
193025CD	SE47/16	47	16	6.3	* .33	.28	.23	
193113CD	SE47/25	47	25	6.3	.39	.35	.29	.25
193199CD	SE47/35	47	35	6.3	* .29	.25	.19	

Part No.	Mfr. Cross Ref. No.†	Value (μF)	Voltage	Dia. (mm)	Pricing			
					1	10	100	500
193295CD	SE47/50	47	50	10.0	* .45	\$.39	\$.35	
192903CD	SE100/6.3	100	6.3	6.3	* .39	.29	.25	
192954CD	SE100/10	100	10	6.3	* .19	.16	.14	
193033CD	SE100/16	100	16	8.0	* .45	.39	.32	
193121CD	SE100/25	100	25	8.0	* .35	.28	.24	
193201CD	SE100/35	100	35	10.0	.39	.35	.31	.26
193308CD	SE100/50	100	50	10.0	* .52	.45	.39	
192911CD	SE220/6.3	220	6.3	6.3	* .29	.26	.23	
192962CD	SE220/10	220	10	8.0	* .37	.29	.25	
193041CD	SE220/16	220	16	8.0	* .39	.35	.29	
193130CD	SE220/25	220	25	10.0	* .59	.49	.43	
193210CD	SE220/35	220	35	8.0	.55	.45	.39	.35
193316CD	SE220/50	220	50	10.0	* .59	.49	.39	
193050CD	SE330/16	330	16	10.0	.49	.44	.39	.34
193148CD	SE330/25	330	25	8.0	* .55	.45	.39	
192920CD	SE470/6.3	470	6.3	8.0	.69	.59	.49	.45
192971CD	SE470/10	470	10	10.0	* .39	.35	.32	
193068CD	SE470/16	470	16	10.0	* .55	.45	.39	
193156CD	SE470/25	470	25	10.0	* .55	.49	.47	
192938CD	SE1000/6.3	1000	6.3	10.0	.55	.45	.39	.35
192989CD	SE1000/10	1000	10	10.0	* .59	.49	.45	
192946CD	SE1500/6.3	1500	6.3	10.0	.69	.55	.49	.44

† Cross Reference: Panasonic: VS Series

Multilayer Ceramic Chip Capacitors
Any surface mount Ceramic Chip Capacitor may be special ordered - 3000 piece minimum.

Resin Molded Chip Tantalum Electrolytic Capacitors (±20%)
Any surface mount Tantalum Chip Capacitor may be special ordered - 2000 piece minimum.

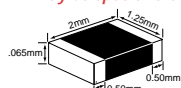

0805 SMT CASE

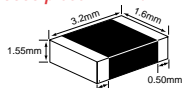

1206 SMT CASE

X7R SERIES (±10%)

0805 SMT Case				Pricing per each			
Part No.	Capacitance	Volt.	100 pc. Increment	Pricing			
				500	1000	3000	5000
87311CD	.01μF	50	\$.12	\$.09	\$.07	\$.065	\$.06
87370CD	.1μF	25	.14	.11	.08	.06	.05

1206 SMT Case				Pricing per each			
Part No.	Capacitance	Volt.	100 pc. Increment	Pricing			
				500	1000	3000	5000
87329CD	.01μF	50	\$.15	\$.09	\$.047	\$.045	\$.038
87388CD	.1μF	50	.19	.17	.15	.11	.10
87396CD	.22μF	25	.22	.15	.10	.085	.08

Z5U SERIES (±20%)

0805 SMT Case				Pricing per each			
Part No.	Capacitance	Voltage	100 pc. Increment	Pricing			
				500	1000	5000	
87177CD	.1μF	50	\$.037	\$.033	\$.028	\$.026	

1206 SMT Case				Pricing per each			
Part No.	Capacitance	Voltage	100 pc. Increment	Pricing			
				500	1000	5000	
87185CD	.1μF	50	\$.08	\$.06	\$.05	\$.04	
87206CD	.22μF	50	.09	.06	.05	.04	
87222CD	.47μF	50	.25	.22	.19	.17	

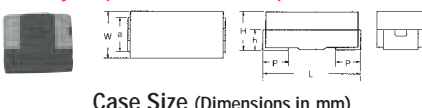

Case Size (Dimensions in mm)

EIA CASE CODE	L ±0.2	W ±0.2	H ±0.2	P ±0.3	a ±0.2	h(min)
A (3216)	3.2	1.6	1.7	0.8	1.2	0.7
B (3528)	3.5	2.8	1.9	0.8	2.0	0.7
C (6032)	6.0	3.2	2.5	1.3	2.0	1.0
D (7343)	7.3	4.3	2.9	1.3	2.4	1.0

10V SMT Tantalum				Pricing per each			
Part No.	Capacitance	Case Size	10 pc. Increment	Pricing			
				100	500	1000	5000
87020CD	10μF	B	\$.55	\$.50	\$.40	\$.32	\$.29
87118CD	100μF	D	1.49	1.35	1.15	.91	.69

16V SMT Tantalum				Pricing per each			
Part No.	Capacitance	Case Size	10 pc. Increment	Pricing			
				100	500	1000	5000
86932CD	1μF	A	\$.39	\$.33	\$.26	\$.22	\$.21
87038CD	10μF	C	.60	.50	.39	.35	.335
87100CD	47μF	D	.95	.85	.79	.69	.65

PLCC Surface Mount Sockets

- Current: 1A
- Dielectric strength: 600VAC for 1 minute
- Insulator resistance: 5000MΩ minimum
- Temperature surface mount: -55°C/+170°C

SALE

152688CD Dimensions in mm

Part #	A & B	C & D	E
152688	23.18	12.70	28.50
152696	30.80	20.32	40.00

Part No.	Mfr. Cross Ref. No.	Pins	1	10	50	100
152688CD	PLCC44D	44	\$.99	\$.79	\$.49	\$.39
152696CD	PLCC68D	68	\$.525	.49	.45	.39

0805 Resistor Assortment (±5%)

144 Values, 50 pcs. each; 7,200 Pieces Total

Resistance Value Chart:

1.2	10	75	430	2.0k	10k	51k	270k	2.2M
1.6	16	85	470	2.2k	11k	56k	300k	2.4M
2.2	18	91	510	2.4k	12k	62k	360k	2.7M
2.4	20	110	560	2.7k	13k	68k	390k	3.0M
2.7	22	120	620	3.0k	15k	75k	430k	3.3M
3.0	24	130	680	3.3k	16k	82k	470k	3.6M
3.3	27	150	750	3.6k	18k	91k	510k	3.9M
4.3	30	160	820	3.9k	20k	100k	560k	4.3M
4.7	33	180	910	4.3k	22k	110k	620k	4.7M
5.1	39	200	1.0k	4.7k	24k	120k	750k	5.1M
5.6	43	220	1.1k	5.6k	27k	150k	820k	5.6M
6.2	47	240	1.2k	6.2k	30k	160k	910k	6.8M
6.8	51	270	1.3k	6.8k	33k	180k	1.0M	7.5M
7.5	56	300	1.5k	7.5k	36k	200k	1.6M	8.2M
8.2	62	360	1.6k	8.2k	39k	220k	1.8M	9.1M
9.1	68	390	1.8k	9.1k	43k	240k	2.0M	10M

- Size (mm): 2.0L x 1.25W x 0.5Thick
- Max. overload voltage: 200V
- 1/8 watts
- Operating temperature: -50°C to 120°C
- Case size (two cases): 10.5"L x 6.7"W x 1.7"H
- Weight: 1.9 lbs.

Includes: Case with labels

Part No.	Mfr. Cross Ref. No.	1	10	25	
172806CD	16-500	\$79.95	\$71.95	\$64.79

1206 Resistor Assortment (±1%)

56 Values, 200 pcs. each; 11,200 pcs. Total

Value Chart (Ohms)

10	200	3.92k	75k
12.1	243	4.99k	90.9k
15	301	6.19k	100k
20	392	7.5k	121k
24.3	499	9.09k	150k
30.1	619	10k	200k
39.2	750	12.1k	243k
49.9	909	15k	301k
61.9	1k	20k	392k
75	1.21k	24.3k	499k
90.9	1.5k	30.1k	619k
100	2k	39.2k	750k
121	2.43k	49.9k	909k
150	3.01k	61.9k	1M

- Max. working voltage: 200V
- Power: 1/8W
- Operating temperature: -55°C to +125°C
- Temp. coefficient: ±100 ppm/°C
- Resistor dimensions (mm): 3.10L x 1.5W x 0.55H

Part No.	Mfr. Cross Ref. No.	1	10	25	
156881CD	SMR1206SB	\$99.99	\$89.99	\$79.99



Aluminum Radial-Lead Electrolytic Capacitors

General purpose low voltage 85°C (A); HT Type 105°C (B) ±20%

Operating temperature range	-40°C to +85°C (A); -40°C to +105°C (B)
Leakage Current (20°C)	After 1 min. 0.03CV or 4µA, whichever is greater
	After 2 min. 0.01CV or 3µA, whichever is greater

SALE

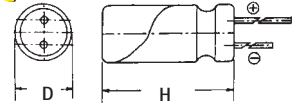

† CROSS REFERENCES: Elna: RC2/RE2; IC: RAR/RSS; Marcon: SEM/SSM; Nichicon: LB/VX/USA/SR/SA; Rubycon: M57/TWSS; Sprague: 501D/513D; UCC: SME/SRE/SRA/SRG; Panasonic: KA/KS/SU

* Prepackaged: order in increments of 10, 100 or 1000

* Prepackaged: order in increments of 10, 100 or 1000

Part No.	Mfr. Cross Ref. No.†	Op. Temp	Value (µF)	Voltage	Size (mm)* D x H	Pricing			
						1	10	100	500
158481CD	RO.47B100	B	0.47	100V	5 x 11.5	*	\$.05	\$.04	\$.03
94160CD	5R1/50	A	1	50V	4 x 5	*	.12	.08	.05
29831CD	R1/50	A	1	50V	5 x 11	*	.057	.048	.038
158490CD	R1B100	B	1	100V	5 x 11.5	*	.06	.05	.04
93729CD	R2.2/50	A	2.2	50V	5 x 11	*	.038	.033	.026
199021CD	R2.2J/100	A	2.2	100V	5 x 11	*	.035	.03	.025
135183CD	R3.3/50	A	3.3	50V	5 x 11	*	.07	.05	.035
31000CD	R4.7/50	A	4.7	50V	5 x 11	*	.038	.033	.026
198838CD	R10J/16	A	10	16V	5 x 11	*	.045	.03	.025
94211CD	5R10/25	A	10	25V	4 x 5	*	.13	.08	.05
94220CD	5R10/35	A	10	35V	5 x 5	*	.15	.12	.06
94369CD	7R10/35	A	10	35V	5 x 7	*	.12	.08	.05
29891CD	R10/50	A	10	50V	5 x 10	*	.06	.05	.04
199048CD	R10J/100	A	10	100V	6.3 x 11	*	.08	.06	.05
158529CD	R10B100	B	10	100V	6 x 11.5	*	.08	.06	.05
158326CD	R22B35	B	22	35V	5 x 11.5	*	.09	.07	.05
198846CD	R22J/16	A	22	16V	5 x 11	*	.045	.04	.03
189918CD	R22J/25	A	22	25V	5 x 11	*	.045	.04	.03
207870CD	R22B/25	B	22	25V	5 x 11	*	.06	.05	.035
198942CD	R22J/35	A	22	35V	5 x 11	*	.035	.03	.025
93737CD	R22/50	A	22	50V	6 x 11	*	.06	.05	.035
199056CD	R22J/100	A	22	100V	6.3 x 11	.30	.21	.14	.09
198854CD	R33J/16	A	33	16V	5 x 11	*	.045	.035	.025
198926CD	R33J/25	A	33	25V	5 x 11	*	.045	.035	.025
93745CD	R33/50	A	33	50V	6 x 11	*	.055	.05	.045
199064CD	R33J/100	A	33	100V	8 x 11.5	*	.11	.10	.09
135301CD	R47/10	A	47	10V	5 x 12	*	.038	.033	.026
198862CD	R47J/16	A	47	16V	5 x 11	*	.045	.035	.025
93753CD	R47/25	A	47	25V	10 x 17	*	.048	.033	.026
198951CD	R47J/35	A	47	35V	5 x 10	*	.05	.04	.03
199072CD	R47J/100	A	47	100V	10 x 12.5	.35	.26	.18	.13
158246CD	R47B25	B	47	25V	5 x 11.5	*	.057	.048	.038
31114CD	R47/50	A	47	50V	6 x 11	*	.06	.05	.045
207811CD	R100/10	A	100	10V	5 x 11	*	.08	.06	.05
94289CD	5R100/16	A	100	16V	6 x 5	*	.15	.12	.09
94431CD	7R100/16	A	100	16V	6 x 7	*	.15	.11	.08
93761CD	R100/25	A	100	25V	6 x 11	*	.09	.07	.05
198969CD	R100J/35	A	100	35V	6.3 x 11	*	.07	.06	.05
29962CD	R100/50	A	100	50V	8 x 11	*	.07	.06	.05
158393CD	R100B50	B	100	50V	8 x 12	*	.11	.09	.07

* Capacitor dimensions and styles may vary

Part No.	Mfr. Cross Ref. No.†	Op. Temp	Value (µF)	Voltage	Size (mm)* D x H	Pricing			
						1	10	100	500
207845CD	R180/16	B	180	16V	6.5 x 15	*	\$.07	\$.06	\$.045
135124CD	7R220/10	A	220	10V	8 x 11	.28	.21	.15	.11
198871CD	R220J/16	A	220	16V	6.3 x 11	.25	.16	.11	.07
30496CD	R220/25	A	220	25V	8 x 11	*	.08	.06	.05
158262CD	R220B25	B	220	25V	8 x 12	*	.12	.09	.07
93770CD	R220/35	A	220	35V	10 x 16	*	.12	.09	.08
93778CD	R220/50	A	220	50V	10 x 20	*	.15	.12	.09
158406CD	R220B50	B	220	50V	10 x 17	*	.17	.15	.14
199081CD	R220J/100	A	220	100V	12.5 x 25	1.10	.85	.63	.39
198889CD	R330J/16	A	330	16V	8 x 11.5	.29	.19	.13	.09
93796CD	R330/25	A	330	25V	10 x 19	*	.20	.15	.11
198977CD	R330J/35	A	330	35V	10 x 12.5	.45	.35	.25	.18
199099CD	R330J/100	A	330	100V	12.5 x 25	1.45	1.10	.79	.59
93809CD	R470/16	A	470	16V	10 x 20	*	.11	.095	.076
158203CD	R470B16	B	470	16V	8 x 12	*	.12	.10	.09
131181CD	R470/25	A	470	25V	10 x 16	*	.12	.10	.09
158289CD	R470B25	B	470	25V	8 x 14	*	.15	.12	.10
93817CD	R470/35	A	470	35V	12 x 24	*	.17	.15	.13
93825CD	R470/50	A	470	50V	13 x 20	.29	.27	.19	.13
158465CD	R470B63	B	470	63V	13 x 21	.30	.27	.24	.21
199101CD	R470J/100	A	470	100V	16 x 25	1.89	1.45	1.10	.80
30015CD	R1000/16	A	1000	16V	13 x 21	*	.16	.14	.12
93833CD	R1000/25	A	1000	25V	12 x 20	*	.29	.23	.19
158297CD	R1000B25	B	1000	25V	10 x 17	.35	.29	.25	.19
158377CD	R1000B35	B	1000	35V	13 x 21	.49	.45	.35	.25
93841CD	R1000/50	A	1000	50V	16 x 26	.52	.46	.41	.34
199110CD	R1000J/100	A	1000	100V	18 x 40	3.59	2.69	1.99	1.55
131145CD	R2200/16	A	2200	16V	16 x 26	.32	.28	.24	.22
30533CD	R2200/25	A	2200	25V	16 x 36	.55	.49	.40	.30
198985CD	R2200J/35	A	2200	35V	16 x 25	1.39	1.25	.99	.74
158431CD	R2200B50	B	2200	50V	16 x 31	.99	.89	.70	.61
198987CD	R3300J/16	A	3300	16V	12.5 x 25	1.25	.99	.73	.49
30891CD	R3300/25	A	3300	25V	16 x 31	.79	.71	.64	.55
198993CD	R3300J/35	A	3300	35V	16 x 35.5	1.95	1.49	1.15	.83
199013CD	R3300J/50	A	3300	50V	18 x 35.5	3.10	2.35	1.75	1.32
198900CD	R4700J/16	A	4700	16V	16 x 25	1.35	.99	.75	.55
93850CD	R4700/25	A	4700	25V	18 x 35	.99	.85	.70	.55
199005CD	R4700J/35	A	4700	35V	18 x 35.5	2.95	2.19	1.69	1.25
163301CD	R4700/50	A	4700	50V	22 x 42	1.99	1.79	1.50	1.31
31510CD	R6800/16	A	6800	16V	18 x 36	1.12	1.01	.88	.79
198934CD	R6800J/25	A	6800	25V	18 x 35.5	2.79	2.15	1.59	1.19

Snap Mount Large Can Aluminum Electrolytic Capacitors (±20%)

- Designed as input filter for switched mode power supply; standard 10mm (.400") snap-in spacing
- Operating temperature range: -40°C to +85°C max. leakage current: 0.02CV (µA) or 3mA whichever is smaller
- Can-Top safety vent

Snap-Ins!



115422CD

† CROSS REFERENCES: Aero M: LP/LPR; Elna: LP3/LP4; Illinois Capacitor: LBA/LPR; Mallory: LPX; Marcon: CEAWF; Nichicon: LLK/LLQ; Panasonic: TS-UP/TS-U; Phillips (MEPCO): 3487/3489; Rubycon: RSP; Sprague: 80D/82D; United Chemicon: SMG(VN)/SMH(VN)

Part No.	Mfr. Cross Ref. No.†	Capacitance	Voltage	Size (mm)* D x H	Pricing		
					1	10	100
203211CD	SN220/400/2	220µF	400V	22 x 51	\$4.99	\$3.99	\$2.99
203220CD	SN220/400/3	220µF	400V	30 x 30	5.95	4.69	3.29
203238CD	SN270/350	270µF	350V	25 x 40	5.95	4.69	3.29
203246CD	SN330/400	330µF	400V	30 x 46	6.95	5.49	4.09
115377CD	SN470/200	470µF	200V	30 x 41	2.49	2.25	1.99
203254CD	SN470/400/4	470µF	400V	35 x 41	6.99	5.69	4.49
203262CD	SN470/400/5	470µF	450V	35 x 51	9.95	7.95	6.39

* Capacitor dimensions and styles may vary

Part No.	Mfr. Cross Ref. No.†	Capacitance	Voltage	Size (mm)* D x H	Pricing		
					1	10	100
155889CD	SN560/200	560µF	200V	23 x 41	\$3.49	\$2.99	\$2.49
203271CD	SN680/200/2	680µF	200V	35 x 25	4.49	3.49	2.75
203289CD	SN680/200/3	680µF	200V	30 x 31	4.95	3.95	3.19
203297CD	SN820/200/4	820µF	200V	30 x 41	4.49	3.49	2.75
203300CD	SN820/200/2	820µF	200V	35 x 25	4.95	3.95	3.19
115422CD	SN4700/50	4,700µF	50V	30 x 41	2.89	2.59	2.35
115431CD	SN6800/50	6,800µF	50V	30 x 51	3.49	3.19	2.89
157737CD	SN10000/50	10,000µF	50V	35 x 40	4.95	4.10	3.99

Aluminum Axial-Lead Electrolytic Capacitors

General purpose low voltage 85°C maximum

Operating temperature range	-40°C to +85°C
Leakage Current (After 2 minutes 20°C)	0.02CV or 2μA, whichever is greater

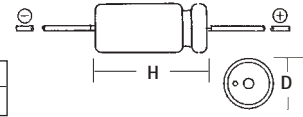

† CROSS REFERENCES: Elna: RE2; IC: RAR; Marcon: SEM; Nichicon: LB/VX; Rubycon: TWSS; Sprague: 501D/513D; UCC: SME; Panasonic: SU

* Prepackaged: order in increments of 10, 100 or 1000

* Prepackaged: order in increments of 10, 100 or 1000

Part No.	Mfr. Cross Ref. No.†	Value (μF)	Voltage	Size (mm)* DxH	Pricing			
					1	10	100	500
10866CD	A1/50	1	50V	5 x 13	*	\$.15	\$.115	\$.09
199128CD	A2.2J/16	2.2	16V	6 x 13	*	.17	.13	.09
93569CD	A2.2/50	2.2	50V	6 x 13	*	.19	.14	.10
199136CD	A3.3J/16	3.3	16V	6 x 12	*	.072	.066	.06
199419CD	A3.3J/50	3.3	50V	6 x 12	*	.23	.12	.09
11076CD	A4.7/50	4.7	50V	6 x 13	*	.18	.13	.11
199427CD	A6.8J/50	6.8	50V	6 x 12	*	.23	.12	.09
199144CD	A10J/16	10	16V	6 x 12	*	.20	.14	.10
199259CD	A10J/25	10	25V	5 x 12	*	.20	.14	.10
93577CD	A10/35	10	35V	6 x 13	*	.19	.14	.10
10882CD	A10/50	10	50V	6 x 12	*	.15	.12	.09
199152CD	A22J/16	22	16V	6 x 12	*	.17	.12	.09
199267CD	A22J/25	22	25V	6 x 12	*	.20	.14	.10
10997CD	A22/50	22	50V	6 x 12	*	.19	.14	.10
199161CD	A33J/16	33	16V	6 x 13	*	.20	.14	.10
199275CD	A33J/25	33	25V	6.3 x 12	*	.23	.12	.09
199347CD	A33J/35	33	35V	6.3 x 16	*	.20	.14	.10
199435CD	A33J/50	33	50V	6.3 x 16	*	.23	.12	.09
199179CD	A47J/16	47	16V	6.3 x 12	*	.20	.14	.10
135319CD	A47/25	47	25V	8 x 16	*	.23	.18	.14
199355CD	A47J/35	47	35V	6.3 x 16	*	.20	.14	.10
11105CD	A47/50	47	50V	8 x 16	*	.19	.14	.10
199443CD	A68J/50	68	50V	8 x 15	.25	.21	.17	.12
199187CD	A100J/16	100	16V	6.3 x 16	.28	.24	.20	.15
199283CD	A100J/25	100	25V	8 x 16	.29	.25	.21	.15
93551CD	A100/35	100	35V	8 x 16	*	.24	.19	.14
10911CD	A100/50	100	50V	8 x 20	*	.25	.19	.15
199195CD	A220J16	220	16V	8 x 16	.28	.24	.20	.15
199291CD	A220J/25	220	25V	8 x 16	.29	.25	.21	.15
199363CD	A220J/35	220	35V	10 x 17	.35	.28	.25	.19

Part No.	Mfr. Cross Ref. No.†	Value (μF)	Voltage	Size (mm)* DxH	Pricing			
					1	10	100	500
11017CD	A220/50	220	50V	10 x 20	\$.29	\$.25	\$.22	\$.18
199208CD	A330J/16	330	16V	8 x 16	*	.10	.095	.086
199304CD	A330J/25	330	25V	10 x 17	.35	.28	.25	.19
199371CD	A330J/35	330	35V	10 x 17	*	.23	.19	.17
199451CD	A330J/50	330	50V	13 x 22	.51	.43	.33	.33
199216CD	A470J/16	470	16V	8 x 16	.35	.28	.25	.19
199312CD	A470J/25	470	25V	10 x 17	.45	.37	.33	.28
199380CD	A470J/35	470	35V	10 x 21	.51	.41	.37	.29
11121CD	A470/50	470	50V	13 x 31	.59	.49	.45	.39
199460CD	A680J/50	680	50V	16 x 25	.81	.69	.54	.44
93631CD	A1000/16	1000	16V	13 x 27	.61	.49	.42	.39
10954CD	A1000/25	1000	25V	13 x 31	.59	.49	.44	.34
93649CD	A1000/35	1000	35V	13 x 26	.79	.71	.65	.57
147256CD	A1000/50	1000	50V	16 x 31	.69	.59	.55	.49
213356CD	A1000/50-1	1000	50V	22 x 41	.69	.59	.55	.49
11033CD	A2200/16	2200	16V	16 x 40	.79	.71	.65	.59
199321CD	A2200J/25	2200	25V	16 x 28	1.11	.90	.78	.59
93657CD	A2200/35	2200	35V	16 x 30	1.25	1.10	.99	.85
199478CD	A2200J/50	2200	50V	18 x 42	2.55	2.10	1.95	1.75
199224CD	A3300/16	3300	16V	16 x 26	.79	.71	.65	.58
93665CD	A3300/25	3300	25V	16 x 32	.89	.79	.69	.59
199398CD	A3300J/35	3300	35V	18 x 37	3.39	2.95	2.29	2.10
199486CD	A3300J/50	3300	50V	22 x 43	4.29	3.55	3.25	2.95
199232CD	A4700J/16	4700	16V	16 x 30	2.10	1.89	1.55	1.15
93673CD	A4700/25	4700	25V	22 x 39	1.59	1.45	1.15	.99
199401CD	A4700J/35	4700	35V	18 x 40	4.85	3.99	3.35	2.99
158810CD	A4700A50	4700	50V	25 x 43	2.79	2.29	2.09	1.79
199241CD	A6800J/16	6800	16V	16 x 33	2.15	1.85	1.39	1.15
199339CD	A6800J/25	6800	25V	18 x 40	1.59	1.45	1.35	1.19
93681CD	A10000/16	10000	16V	22 x 51	2.25	2.05	1.65	1.19

* Capacitor dimensions and styles may vary

Ceramic Disc Capacitors (±20%)

25, 50 and 1000 Volt, Z5U Temperature Coefficient



Low Voltage
50VDC Ceramic

Operating temperature range	+10°C to +85°C
Cap. change over temp. range	+22% to -56%
Dielectric withstanding voltage	2.5 times rated volt. for not < 1 sec.

Any Ceramic Disc Capacitor can be special ordered on ammo-style tape – 1000 piece minimum

Prepackaged: order in increments of 10, 100 or 1000

Part No.	Mfr. Cross Ref. No.	Capacitance	Voltage	Dia.* (mm)	Pricing			
					10	100	1000	5000
135141CD	DC2.2	2.2pF	50V	5	\$.05	\$.035	\$.02	\$.015
15333CD	DC10	10pF	50V	5	.07	.05	.02	.015
15405CD	DC22	22pF	50V	6	.07	.05	.025	.02
15510CD	DC47	47pF	50V	5	.05	.035	.02	.015
15341CD	DC100	100pF	50V	5	.05	.035	.025	.02
15413CD	DC220	220pF	50V	5	.05	.035	.025	.015
15528CD	DC470	470pF	50V	5	.08	.065	.025	.022
207853CD	DC820/1000	820pF	1000V	14	.06	.04	.03	.02
15190CD	DC.001	.001μF	50V	6	.06	.05	.025	.022
97341CD	DC.0022/1K20	.0022μF	1000V	11	.18	.12	.084	.066
15211CD	DC.0047	.0047μF	50V	6	.05	.035	.03	.02
15229CD	DC.01	.01μF	50V	6	.06	.04	.03	.02
97375CD	DC.01/1K20	.01μF	1000V	12	.18	.12	.084	.066
15245CD	DC.022	.022μF	50V	8	.07	.05	.04	.03
15253CD	DC.047	.047μF	50V	8	.084	.069	.057	.04
151116CD	DC.1/25	.1μF	25V	6	.14	.13	.08	.07
15270CD	DC.1	.1μF	50V	8	.15	.13	.115	.095

* Capacitor dimensions and styles may vary

Monolithic Ceramic Capacitors (±20%) (Z5U Series)

Applications:
• Data processing
• Communications engineering

Operating temperature range: -10°C to +85°C

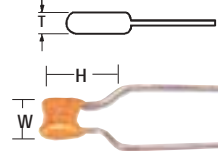

Any Ceramic Disc Capacitor can be special ordered on ammo-style tape – 1000 piece minimum

* Prepackaged: order in increments of 10, 100 or 1000

Part No.	Mfr. Cross Ref. No.	Capacitance	Volt.	Size (mm)* W x T x H	Pricing				
					1	10	100	5000	
81541CD	MD10	10pF	50V	3.5 x 2.0 x 3.0	*	\$.10	\$.07	\$.045	\$.045
81533CD	MD22	22pF	50V	4.0 x 2.0 x 4.0	*	.095	.073	.045	.04
81525CD	MD100	100pF	50V	3.5 x 2.0 x 3.0	*	.09	.07	.045	.035
81517CD	MD.001	.001μF	50V	4.5 x 2.0 x 3.0	*	.09	.07	.05	.035
138181CD	MD.0022	.0022μF	50V	4.0 x 2.0 x 5.5	*	.07	.06	.05	.04
138202CD	MD.0047	.0047μF	50V	5.0 x 2.0 x 5.5	*	.09	.07	.05	.035
25507CD	MD.01	.01μF	50V	3.5 x 2.0 x 3.0	*	.09	.06	.04	.035
57621CD	MD.047	.047μF	50V	2.5 x 2.5 x 3.0	*	.10	.07	.05	.045
25523CD	MD.1	.1μF	50V	6.0 x 2.0 x 4.0	*	.07	.06	.04	.035
25540CD	MD.22	.22μF	50V	6.0 x 2.0 x 4.5	*	.17	.12	.08	.06
138237CD	MD.33	.33μF	50V	6.0 x 2.0 x 8.0	*	.20	.17	.11	.07
25558CD	MD.47	.47μF	50V	4.5 x 2.5 x 4.5	*	.25	.19	.13	.12
81509CD	MD1	1μF	50V	6.0 x 3.0 x 7.0	.48	.43	.32	.23	.37

* Capacitor dimensions and style may vary

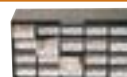

See page 111 for Axial Electrolytic Capacitor Cabinet Kit.



Mylar Capacitors (±10%) Metalized Polyester Film Capacitors

- High performance at low cost • Non-inductive construction

Operating temperature range	-40°C to +85°C
Dissipation factor	≤.01 (at 1kHz)
Dielectric strength	150% of rated voltage for 5 sec.



† Cross References:

Panasonic: ECQ-E Series; **Sprague:** DF/450P/451P/453P; **Westlake:** 160/168/185/167/184/186; **Rubycon:** MC/MN; **Mepco:** 713A1/719A1/C280; **TRW:** X601PE/X601CPE; **Packtron:** MF/RB; **Secor:** MMKS/MMKR/MMDR; **RIFA:** PHE353/PHE354; **Roederstein:** MKT 1818/MKT 1822; **WIMA:** MKS; **CSF Thompson:** MD/ MC; **Siemens:** B325X-XX; **NIC:** NEM/NRM; **Nichicon:** DDXM; **Phillips:** 712 A1 series
Any Mylar Capacitor can be special ordered on ammo-style tape - 1000 piece minimum

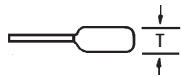

* Prepackaged: order in increments of 10, 100 or 1000

Part No.	Mfr. Cross Ref. No.†	Capacitance	Volt. (V)	Size (mm)* L x T x H	Pricing			
					1	10	100	1000
26833CD	MY.001	.001µF	100	7.0 x 3.0 x 7.0	*	\$.10	\$.07	\$.05
207802CD	MY.0015/1000	.0015µF	1000	23.5 x 5.1 x 10.7	*	.09	.05	.04
26868CD	MY.0022	.0022µF	100	6.0 x 3.0 x 10.0	*	.10	.06	.04
26876CD	MY.0047	.0047µF	100	6.0 x 3.0 x 9.0	*	.14	.13	.11
207829CD	MY.0068/220	.0068µF	220	18.0 x 5.5 x 10.0	*	.10	.06	.04
26884CD	MY.01	.01µF	100	6.0 x 3.0 x 7.0	*	.10	.06	.04
207837CD	MY.018/50	.018µF	50	6.1 x 2.6 x 11.3	*	.09	.05	.04
26905CD	MY.022	.022µF	100	6.0 x 3.0 x 10.0	*	.15	.10	.06
26921CD	MY.033	.033µF	100	8.0 x 4.0 x 11.0	*	.15	.10	.06
207861CD	MY.033/400	.033µF	400	11.0 x 4.0 x 8.0	*	.10	.06	.04
26930CD	MY.047	.047µF	100	8.0 x 4.0 x 12.0	*	.15	.10	.06
135562CD	MY.1/50	.1µF††	50	14.0 x 6.0 x 12.0	*	.13	.09	.05
26956CD	MY.1	.1µF	100	12.5 x 5.0 x 9.5	*	.17	.12	.07
93921CD	MY.1/250	.1µF	250	12.5 x 5.5 x 10	*	.19	.16	.13
26972CD	MY.22	.22µF	100	12.5 x 5.5 x 10	*	.19	.12	.085
93964CD	MY.33/250	.33µF	250	18.0 x 7.0 x 12.5	.32	.25	.21	.19
26999CD	MY.47	.47µF	100	18.0 x 6.0 x 11.5	.32	.25	.20	.17
27001CD	MY1	1µF	100	18.0 x 7.5 x 14.0	.59	.49	.44	.31
93981CD	MY1/250	1µF	250	26.0 x 9.0 x 16.0	.89	.69	.49	.29
93999CD	MY2.2/250	2.2µF	250	26.0 x 9.0 x 16.0	.75	.65	.55	.45

†† ±20% tolerance *Capacitor dimensions and styles may vary

Dipped Tantalum Capacitors (±10%) Resin Dipped Solid Tantalum Capacitors

- Flame retardant coating • Exceptional temperature stability
- Low leakage current • Moisture-resistant
- Designed for entertainment and commercial equipment

Operating temp. range	-55°C to +85°C (+125°C with derating)
Rated voltage DC	≤ +85°C

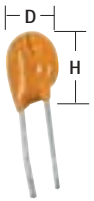

† Cross References:

Panasonic: EF Series; **AVX:** Tap Series; **Sprague:** 196D and 199D; **Matsuo:** 202; **Kemet:** T350/ T360; **Mepco:** 49GS; **NEC:** DN; **Nichicon:** 599; **NIC:** NDTM; **Hitachi:** TSD-3
 * Prepackaged: order in increments of 10, 100 or 1000

Part No.	Mfr. Cross Ref. No.†	Capacitance	Voltage (V)	Size (mm)* D x H	Pricing			
					1	10	100	1000
33486CD	TM.1	.1µF	35	4.5 x 7.0	*	\$.25	\$.20	\$.18
33507CD	TM.22	.22µF	35	4.5 x 7.0	*	.25	.19	.15
33523CD	TM.33	.33µF	35	4.5 x 7.0	*	.17	.15	.13
33531CD	TM.47	.47µF	35	4.5 x 7.0	*	.25	.19	.17
61102CD	TM.68	.68µF	35	2.9 x 5.1	*	.25	.19	.17
154860CD	TM1/25	1µF	25	3.0 x 6.0	*	.29	.25	.22
33662CD	TM1	1µF	35	4.5 x 7.0	*	.29	.25	.22
94001CD	TM2.2/16	2.2µF	16	4.5 x 7.0	*	.29	.25	.22
94019CD	TM2.2/25	2.2µF	25	4.5 x 7.0	*	.35	.29	.25
33734CD	TM2.2	2.2µF	35	4.5 x 7.5	.39	.35	.29	.25
33769CD	TM3.3	3.3µF	35	4.5 x 7.5	.63	.56	.49	.39
94035CD	TM4.7/16	4.7µF	16	4.5 x 7.5	.47	.38	.28	.20
94043CD	TM4.7/25	4.7µF	25	5.0 x 8.5	.50	.45	.39	.35
33806CD	TM4.7	4.7µF	35	5.5 x 9.0	.55	.48	.37	.27
33873CD	TM6.8	6.8µF	35	6.0 x 10.0	.62	.55	.40	.36
94060CD	TM10/16	10µF	16	5.0 x 9.0	.45	.40	.31	.26
94078CD	TM10/25	10µF	25	5.5 x 9.0	.59	.50	.40	.36
33689CD	TM10	10µF	35	6.0 x 10.0	.89	.79	.69	.59
33718CD	TM15	15µF	25	6.0 x 10.0	.89	.80	.65	.49
33751CD	TM22	22µF	6.3	5.0 x 9.0	.45	.35	.31	.27
94094CD	TM22/16	22µF	16	6.0 x 10.0	.69	.59	.49	.45
94107CD	TM22/25	22µF	25	7.0 x 10.5	1.79	1.60	.93	.89
33785CD	TM33	33µF	25	8.0 x 13.0	2.59	2.25	1.79	1.22
94123CD	TM47/16	47µF	16	8.0 x 13.0	1.69	1.55	1.36	.99
33822CD	TM47	47µF	25	9.0 x 14.5	3.29	2.95	2.65	2.39
33700CD	TM100	100µF	6.3	7.0 x 10.5	1.19	1.09	.95	.85

*Capacitor dimensions and styles may vary

5mm Ceramic Trimmer Capacitor

- Working voltage: 200VDC
- Withstand voltage: 400VDC
- Turning torque: 35-200 g-cm
- Operating temperature range: -30°C~+85°C
- Insulation resistance: >10MΩ min. @ 250VDC

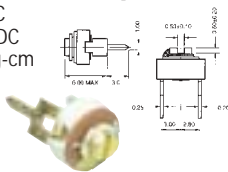

Part No.	Capacitance Range (pF)	Q Factor @ 1MHz	Color Codes	Pricing		
				1	10	1000
136979CD	9.0-50.0	> 200	Green	\$.89	\$.79	\$.59

8mm .315" Ceramic Trimmer Capacitors (250VWVDC) Thru Hole

- Working voltage: 250VDC
- Withstand voltage: 550VDC
- Turning torque: 40-200 g-cm
- Operating temperature range: -55°C~+85°C
- Insulation resistance: 10MΩ min. @ 250VDC

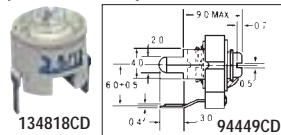

Part No.	Capacitance Range (pF)	Q Factor @ 1MHz	Color Codes	Pricing			
				1	10	100	1000
134818CD	3.5-13.0	> 300	Ivory	\$.69	\$.65	\$.50	\$.39
32838CD	4.0-34.0	> 300	Yellow	.99	.79	.69	.59
32854CD	6.0-70.0	> 200	Nil	1.05	.85	.75	.65
94449CD	8.5-100	> 200	Purple	1.05	.93	.81	.77
94465CD	8.5-120	> 200	Nil	.99	.79	.65	.59

Memory Back-Up Capacitors

Applications:

- Back-up on CMOS microcomputers, static RAM, DTSS (digital tuning systems)
- Memory back-up of remote controllers

Features:

- Excellent voltage holding characteristics for low back-up currents
- Small size vs. capacitance • Voltage: 5.5VDC
- Capacitance ranges from .047 to 1F

Capacitor dimensions and lead spacing may vary



142922CD

Part No.	Mfr. Cross Ref. No.	Capacitance (Farad)	Pricing		
			1	10	100
142922CD	MBC.047/5.5	.047	\$1.65	\$1.43	\$1.25
142949CD	MBC.22/5.5	.22	2.29	1.99	1.60
143010CD	MBC.47/5.5	.47	3.49	2.95	2.25
142957CD	MBC1.0/5.5	1.0	4.75	4.29	3.49



See page 111 for Mylar & Dipped Tantalum Capacitor Cabinet Kits.

Dipped Silver Mica Capacitors (±5%) Metalized Polyester Film Capacitors

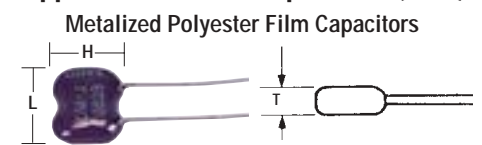

Case type	DM15
Lead space (in.)	.23
Tolerance	±5%
Operating temperature range	-55°C to +125°C
Size (mm) - L x T x H*	11 x 4 x 9

*Capacitor dimensions and style may vary

Part No.	Mfr. Cross Ref. No.	Capacitance	Volt. (V)	Pricing			
				1	10	100	1000
15991CD	DM100	10pF	500	\$.49	\$.39	\$.29	\$.25
16037CD	DM220	22pF	500	.49	.39	.29	.23
16070CD	DM330	33pF	500	.49	.39	.29	.23
16096CD	DM470	47pF	500	.45	.37	.31	.28
16002CD	DM101	100pF	500	.49	.39	.31	.27
16088CD	DM331	330pF	500	.95	.75	.55	.35
16109CD	DM471	470pF	500	1.05	.95	.79	.65
16011CD	DM102	1000pF	100	1.09	.97	.89	.75



See page 85 for Surface Mount Capacitors



Carbon Film Resistors and Resistor Networks

1/4-Watt Carbon Film Resistors (±5%)



Single Resistor Value Pricing: 1/4-Watt Carbon Film Resistors (±5%)

To order: Use 5-digit part number adjacent to ohms in chart below
Values may not be combined for quantity price breaks

Specify Part No. & Resistor Value (see Standard Resistor Value Chart below)	Pricing (Sold in bags of 100 pieces)			
	1 Bag	10 Bags	50 Bags	100 Bags
	\$.99/bag	\$.57/bag	\$.49/bag	\$.46/bag

99¢/bag
100 piece bags

Assortment Pricing: 1/4-Watt Carbon Film Resistor (±5%)

Assortments may not be combined for quantity price breaks

Part No.	Description (Including bulk pack values)	1	10	25
10719CD	5 ea. 70 values (every other value from 10Ω - 5.6 MΩ) (350 pcs.)	\$9.95	\$8.95	\$7.95
103165CD	10 ea. 24 values marked (●) and 50 ea. 6 values marked (X) (540 pcs.)	12.95	11.49	9.95
10663CD	100 ea. 27 values marked (▲) (2,700 pcs.)	24.95	22.49	20.49
10655CD	100 ea. 160 values (all resistor values in the chart below) (16,000 pcs.)	119.95	107.95	96.95
81832CD	1/4-watt resistor component cabinet kit - 30 values (540 pcs.), pg 110	27.95	24.95	22.49

▲ see table on top right

Standard Resistor Values Chart

Part No.	Ohms	Part No.	Ohms	Part No.	Ohms	Part No.	Ohms	Part No.	Ohms	Part No.	Ohms	Part No.	Ohms	Part No.	Ohms
30293CD	2.2	59192CD	15	29946CD ▲X	100	31499CD ▲●	680	31026CD ▲X	4.7k	30841CD ▲●	33k	30525CD	220k	29778CD	1.5M
30349CD	2.4	30197CD	16	30040CD	110	31561CD	750	31237CD ▲●	5.1k	30912CD	36k	30576CD	240k	29794CD	1.6M
30373CD	2.7	30234CD	18	30082CD	120	31624CD	820	31270CD ▲●	5.6k	30955CD	39k	30613CD	270k	29815CD	1.8M
30621CD	3.0	30411CD	20	30120CD	130	31691CD	910	31405CD	6.2k	31077CD	43k	30808CD	300k	30285CD	2.0M
30656CD	3.3	65736CD	22	30162CD ▲●	150	29663CD ▲X	1.0k	31430CD	6.8k	31149CD ▲●	47k	30883CD	330k	30331CD	2.2M
30699CD	3.6	30541CD	24	59248CD	160	29719CD	1.1k	31536CD	7.5k	31309CD	51k	30939CD	360k	30365CD	2.4M
30728CD	3.9	30584CD	27	59281CD	180	29735CD ●	1.2k	31595CD	8.2k	31350CD	56k	30971CD	390k	30402CD	2.7M
30980CD	4.3	30752CD	30	59424CD	200	58931CD	1.3k	60353CD	9.1k	31456CD	62k	31093CD	430k	30648CD	3.0M
59811CD	4.7	30824CD	33	30470CD ▲X	220	29760CD ▲●	1.5k	29911CD ▲X	10k	31481CD	68k	31202CD ▲●	470k	30681CD	3.3M
31211CD	5.1	30904CD	36	30568CD	240	29786CD	1.6k	30031CD	11k	31552CD	75k	31325CD	510k	30710CD	3.6M
31253CD	5.6	59723CD	39	30605CD ▲●	270	29807CD	1.8k	30074CD	12k	31616CD	82k	31384CD	560k	30744CD	3.9M
31392CD	6.2	31069CD	43	30795CD	300	30277CD ▲●	2.0k	30111CD	13k	31683CD	91k	31472CD	620k	31051CD	4.7M
31421CD	6.8	31106CD ▲●	47	30867CD ▲●	330	30314CD ▲●	2.2k	30146CD ▲●	15k	29997CD ▲X	100k	31501CD	680k	31245CD	5.1M
31528CD	7.5	31296CD	51	30921CD	360	30357CD	2.4k	30200CD	16k	30058CD	110k	31579CD	750k	59934CD	5.6M
31587CD	8.2	31341CD	56	30963CD ●	390	30390CD ▲●	2.7k	30242CD	18k	30091CD	120k	31632CD	820k	31413CD	6.2M
31641CD	9.1	60089CD	62	31085CD	430	30630CD	3.0k	30429CD ●	20k	30138CD	130k	31704CD	910k	31448CD	6.8M
29882CD ▲●	10	60134CD	68	31165CD ▲●	470	30672CD ▲●	3.3k	30453CD ▲●	22k	30171CD	150k	29698CD ▲●	1.0M	60206CD	7.5M
59061CD	11	60222CD	75	31317CD	510	30701CD	3.6k	30550CD	24k	30226CD	160k	29724CD	1.1M	31608CD	8.2M
30066CD	12	60302CD	82	31376CD	560	30736CD	3.9k	30592CD	27k	30269CD	180k	29743CD	1.2M	31667CD	9.1M
30103CD	13	31675CD	91	31464CD	620	59782CD	4.3k	30779CD	30k	30437CD	200k	29751CD	1.3M	29938CD ▲●	10M

Elec. Component

1/8-Watt Carbon Film Resistor (±5%) Assortments

Any 1/8 or 1/2-Watt Resistor value (below) can be special ordered - 1000 pc minimum

• 1/8-W - \$12.95/k (bulk) • 1/2-W - \$15.95/k (bulk)

Part No.	Cross Ref. No.	Values included	Description (see chart below)	Pricing	
				1	10
108302CD	ASST1830	X	10 ea. of 24 values marked by X and 50 ea. of 6 values marked below by # (540 pcs.)	\$12.95	\$11.49
108290CD	ASST1827	✓	100 ea. of 27 values marked by ✓ (2,700 pcs.)	29.95	26.95
108329CD	CAB182R	-	1/8-watt resistor component cabinet kit - 30 values (540 pcs.), see page 110	24.95	22.49

1/8 & 1/2-Watt Resistor Assortments Value Chart (Ohms)

10 ✓X	150 ✓X	330 ✓X	680 ✓X	2.0k ✓X	3.3k ✓X	5.6k ✓X	15k ✓X	33k ✓X	470k ✓X
47 ✓X	220 ✓#	390 X	1.0k ✓#	2.2k ✓X	4.7k ✓#	6.8k X	22k ✓X	47k ✓X	1.0M ✓X
100 ✓#	270 ✓X	470 ✓X	1.5k ✓X	2.7k ✓X	5.1k ✓X	10k ✓#	27k X	100k ✓#	10M ✓X

(✓), (X), (#) symbols indicate Resistor values included in Assortments above and below.

1/2-Watt Carbon Film Resistor (±5%) Assortments

Any 1/8 or 1/2-Watt Resistor value (above) can be special ordered - 1000 pc minimum

• 1/8-W - \$12.95/k (bulk) • 1/2-W - \$15.95/k (bulk)

Part No.	Cross Ref. No.	Values Included	Description (see chart above)	Pricing	
				1	10
107852CD	ASST1230	X	10 ea. of 24 values marked by X and 50 ea. of 6 values marked by # (540 pcs.)	\$14.95	\$13.49
107844CD	ASST1227	✓	100 ea. of 27 values marked by ✓ (2,700 pcs.)	34.95	31.49
107836CD	ASST1270	-	5 ea. of 70 values (every other value from 10Ω - 5.6MΩ)(350 pcs.) (see chart above)	10.95	9.95
107879CD	CAB12R	-	1/2-watt resistor component cabinet kit - 30 values (540 pcs.), see page 110	29.95	26.95

Single-In-Line "SIP" Resistor Networks (±2%)

8 and 10-Pin Bussed (125mW/Resistor) ±2%

Features (8BRN/10BRN):

- 8-pin package (7 resistors) = 8BRN
- 10-pin package (9 resistors) = 10BRN
- Rated power per resistor at 70°C: 125mW/resistor
- Operating temperature range: -55°C to +125°C
- Resistance temperature coefficient: 200ppm/°C
- Max. working voltage: 100V or rated power x resistance, whichever is smaller
- Insulation resistance:
 - * 10,000MΩ min. at 100V
- Solderability: per MIL-R-83401
- Low profile 5mm (.200" body ht.)
- Low profile is compatible w/ DIPs
- Cermet thick film construction

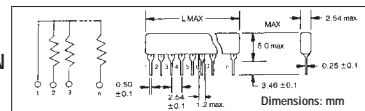

Part No.	Pins	Ohms
97826CD	8	10k
97851CD	10	330
97869CD	10	470
97877CD	10	1.0k
97893CD	10	2.2k
24660CD	10	4.7k
24643CD	10	10k
98087CD	10	47k
98095CD	10	100k

Dual-In-Line "DIP" Resistor Networks (±2%)

16-Pin Isolated (140mW/Resistor) ±2%

Features (161RN):

- Maximum operating voltage: 100V
- Temperature coefficient: ±100ppm/°C
- Operating temp.: -55°C to +125°C
- Insulation resistance: 10,000MΩ min.
- Lead solderability/solvent resistance: meets requirements of MIL-R-83401
- Power rating at 70°C: 2.25 watts
- Compatible with automatic insertion equipment
- Copper leads for excellent heat dissipation

Part No.	Ohms
164005CD	33
108556CD	100
108564CD	220
108572CD	330
108581CD	470
108599CD	1.0k
108610CD	4.7k
108628CD	10k
108644CD	100k

SIP and DIP Resistor Network Cross Reference Chart

Jameco	CTS	A - B	Bourns	Dale	Beckman	Sprague	MEPCO
8BRN...	770-81-R...	708A...	4608X-101...	CSC08A01...	L08-1-R...	356CF... X2PD	9S08... GL002
10BRN...	770-101-R...	710A...	4610X-101...	CSC10A01...	L10-1-R...	256CX... X2PD	9S10... GL002
161RN...	761-3-R...	316B...	4116R-001...	MDP16-03...	898-3-R...	916C... X5SR	D16H... 12-J

1/2-Watt Trimming Potentiometers ($\pm 10\%$)

- Linear taper
- Absolute min. resistance: 1% or 2Ω max.
- Contact resistance variation: 1% or 3Ω max.
- Insulation resistance: 500VDC; 1,000M Ω min.
- Rotational life: 200 cycles
- Terminals: solderable pins

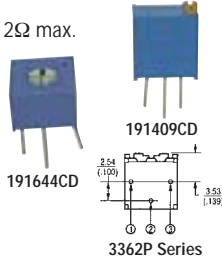

Cross Reference Chart

Equivalent to:	
3362P Series	
Bourns	3362P
Copal	CT-6P
Murata	PVC6
Vishay	76
3299Y Series	
Bourns	3299Y
Spectrol	64Y
Vishay	1248
Murata	PV37W

3362P Series

- Top adjustment: 240° nominal
- Wiper positioning: 50% nominal

Part No.	Mfr. Cross Ref. No.	Ohms	1	10	100	500
191644CD	3362P-1-200	20	\$.29	\$.25	\$.22	\$.19
189341CD	3362P-1-500	50	.59	.55	.45	.41
182810CD	3362P-1-501	500	.77	.66	.41	.29
182828CD	3362P-1-502	5k	.77	.65	.55	.48
182836CD	3362P-1-103	10k	.77	.65	.55	.48
182844CD	3362P-1-204	200k	.77	.65	.55	.48
182852CD	3362P-1-105	1M	.77	.65	.55	.48

3299Y Series • 3/8" square, 25-turn potentiometer

- Load Life: 1,000 hours 0.5W @ 70°C
- Wipers set @ CW end

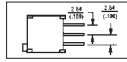

Part No.	Mfr. Cross Ref. No.	Ohms	1	10	100
191417CD	3299Y-1-501	500	\$2.25	\$2.09	\$1.65
191396CD	3299Y-1-102	1k	2.25	2.09	1.65
191425CD	3299Y-1-502	5k	2.25	2.09	1.65
191409CD	3299Y-1-104	100k	2.25	2.09	1.65

NTC Thermistors

- Typical applications: temperature measurement/control/compensation; power supply fan control; PCB temperature monitoring
- Operating temperature range: -30°C ~ $+130^\circ\text{C}$
- Maximum allowable power (@ 250°C): 0.55W
- Thermal dissipation factor: 6.5mW/OC (@ 250°C)
- Resistance value allowable difference: 10%



Part No.	Mfr. Cross Ref. No.	Resistance (Ω @ 25°C)	B Constant ($25/50^\circ\text{C} > 10\%$)	Temp. Coef. @ 25°C (%/C)	Pricing			
					1	10	100	500
207520CD	NTC-101	100	3100	-3.5	\$.59	\$.53	\$.40	\$.33
207511CD	NTC-201	200	3100	-3.5	.59	.53	.40	.33
207503CD	NTC-301	300	3100	-3.5	.59	.53	.40	.33
207491CD	NTC-501	500	3100	-3.5	.59	.53	.40	.33
207482CD	NTC-102	1k	3800	-4.3	.59	.53	.40	.33
207474CD	NTC-202	2k	3800	-4.3	.59	.53	.40	.33
207466CD	NTC-302	3k	3900	-4.4	.59	.53	.40	.33
207458CD	NTC-402	4k	3900	-4.4	.59	.53	.40	.33
207440CD	NTC-502	5k	3900	-4.4	.59	.53	.40	.33
207036CD	NTC-103	10k	4100	-4.6	.59	.53	.40	.33
207028CD	NTC-153	15k	4100	-4.6	.59	.53	.40	.33
207010CD	NTC-203	20k	4200	-4.7	.59	.53	.40	.33
207001CD	NTC-503	50k	4200	-4.7	.59	.53	.40	.33
206990CD	NTC-104	100k	4400	-4.9	.59	.53	.40	.33
206981CD	NTC-204	200k	4500	-5.1	.59	.53	.40	.33

LA Series Varistors (Radial Lead)

- AC power line applications
- Power supplies
- UL recognized as "transient voltage surge suppressors"
- UL recognized as "across-the-line components"
- High energy absorption

LA Series		Size	Max. Ratings ($+85^\circ\text{C}$)				Characteristics at 25°C				
Part No.	Mfr. Cross Ref. No.		Continuous		Transient Energy (10/1000 μs)	Max Clamping Volt. @ I_p Value Curr. (8/20 μs)		Pricing			
		RMS Volt.	DC Volt.	V _{m(ac)} Volts		V _{m(dc)} Volts	W _{tm} Joules	V Volts	Ip=2.0A Amps	1	10
3446CD	V130LA10A	14	130	175	38	340	50	.55	.49	.45	.39
34471CD	V250LA20A	14	250	330	72	650	50	.58	.52	.47	.42
34462CD	V130LA20A	20	130	175	70	340	100	.54	.52	.50	.48

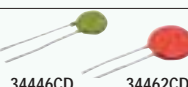

High Current Toroid Inductors

5700 Series

- Low radiation
- Low core loss
- High current capacity
- Size: A = 22.22mm max.; B = 11.09mm max.; C = 15.0 \pm 1.0mm; D = 1.2 \pm 0.5mm
- See page 48 for EMI suppression cores

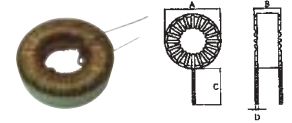

Part No.	L (μH)	IDC max. (A)	L min. @ IDC	1	50	100	250
208258CD	10	11.0	5	\$2.99	\$2.69	\$2.39	\$2.19
208266CD	25	5.5	12	2.99	2.69	2.39	2.19
208311CD	50	9.5	25	3.99	3.59	3.19	2.89
208303CD	75	5.0	40	3.39	2.99	2.69	2.39
208274CD	125	2.75	70	2.99	2.69	2.39	2.19
208320CD	150	4.75	85	3.99	3.59	3.19	2.89
208282CD	275	2.0	150	3.39	2.99	2.69	2.39
208291CD	450	1.5	250	3.39	2.99	2.69	2.39

Axial Leaded RF Chokes

4600 Series

- Inductive tolerance: 10%
- Test frequency: 7.9MHz
- Size: A = 6.8mm max.; B = 19.0mm max.; C = 25.0 \pm 2.0mm; D = 0.65 \pm 0.5mm

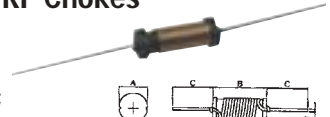

Part No.	L (μH)	Q (min.)	Res. Freq Min. (MHz)	DCR Max. (μ)	Max. DC Current (mA)	Pricing		
						1	100	250
208063CD	1.0	60	190	.050	2000	\$.89	\$.69	\$.49
208071CD	1.5	58	149	.093	1800	.89	.69	.49
208080CD	2.4	56	120	.190	1500	.89	.69	.49
208098CD	3.9	60	93	.450	1000	.89	.69	.49
208101CD	5.5	57	80	.670	850	.89	.69	.49
208119CD	6.2	57	76	.830	700	.89	.69	.49
208127CD	8.2	57	65	1.2	600	.89	.69	.49
208135CD	10	36	61	1.5	500	.89	.69	.49

Epoxy Conformal Coated Chokes

- Operating temperature: -25°C to $+85^\circ\text{C}$
- Tolerance: 5%
- Size: A = 3.2mm max.; B = 7.0mm max.; C = 0.48 \pm 0.5mm (except P/N 208143: 0.50 \pm 0.05mm); D = 63 \pm 3mm



Part No.	L (μH)	Q (min.)	Test. Freq (MHz)	Res. Freq Min. (MHz)	DCR Max. (μ)	Max. DC Curr. (mA)	Pricing		
							1	100	250
208143CD	10	60	7.96	28.7	1.56	670	\$.49	\$.39	\$.29
208151CD	27	50	2.52	10.2	2.39	410	.49	.39	.29
208160CD	33	50	2.52	8.4	2.71	380	.49	.39	.29
208178CD	47	50	2.52	6.9	3.3	330	.49	.39	.29
208186CD	82	45	2.52	5.4	4.62	240	.49	.39	.29
968194CD	100	45	2.52	5.0	4.98	240	.49	.39	.29
208207CD	220	45	0.796	3.3	9.23	180	.49	.39	.29
208215CD	330	45	0.796	2.7	13.2	140	.49	.39	.29
208223CD	470	45	0.796	2.2	21.4	120	.49	.39	.29
208231CD	820	45	0.796	1.7	28.4	90	.49	.39	.29
208240CD	1000	45	0.796	1.5	31.3	80	.49	.39	.29

ZA Series Varistors (Radial Lead)

- Low DC voltage applications
- UL recognized as "transient voltage surge suppressors"
- Used for highly sensitive devices
- Low transient energy
- Printed circuit board designs
- Computer equipment
- Alarm systems

* Prepackaged: order in increments of 10, 100 or 1000

ZA Series		Size	Characteristics at 25°C					Pricing				
Part No.	Mfr. Cross Ref. No.		Disc. Dia. (mm)	Varistor Voltage @ 1 mA DC Test Current		Max. V _{N(dc)} Volts	Max. Clamping Volt. @ I_p Value Curr. (8/20 μs)		96891CD			
		Min. Volts		Max. Volts	V Volts		Ip=2.0A Amps	1	10	100	1000	
96891CD	V8ZA1	7	6.0	8.2	11.0	22	5	*	\$.13	\$.12	\$.11	
190449CD	V18ZA1	7	16.0	18.0	20.0	35	2.5		.29	.25	.22	.19

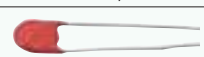

Resettable Fuses

Resettable fuses improve reliability and lower costs. Polymer Positive Temperature Coefficient (PPTC) fuses have provided designers in numerous industries a new tool in their battle to improve product quality and performance. As PPTC fuses are resettable, warranty costs and service calls are largely avoided.

RA Series

- Rated voltage: (V_{MAX}, V): 60
- Max. current: (I_{MAX}, A): 40
- Lead length (D): 7.6mm (min.)
- Thickness (E): 3.1mm (min.)

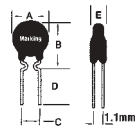

Fig. 1

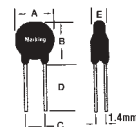

Fig. 2

RB Series

- Rated voltage: (V_{MAX}, V): 30
- Max. current: (I_{MAX}, A): 40
- Lead length (D): 7.6mm (min.)
- Thickness (E): 3.0mm (min.)

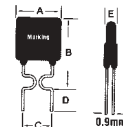

Fig. 3

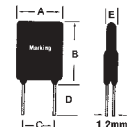

Fig. 4

Part No.	Mfr. Ref. No.	Hold Curr. (I _H , A)	Trip Curr. (I _T , A)	Fig.	Size (mm)			Pricing			
					A	B	C	1	10	100	500
199814CD	RA010-60	0.10	0.20	1	7.4	12.7	5.1	\$.47	\$.44	\$.41	\$.38
199822CD	RA017-60	0.17	0.34	1	7.4	12.7	5.1	\$.47	\$.44	\$.41	\$.38
199831CD	RA020-60	0.20	0.40	1	7.4	12.7	5.1	\$.47	\$.44	\$.41	\$.38
199849CD	RA025-60	0.25	0.50	1	7.4	12.7	5.1	\$.47	\$.44	\$.41	\$.38
199857CD	RA030-60	0.30	0.60	1	7.4	13.0	5.1	\$.47	\$.44	\$.41	\$.38
199865CD	RA040-60	0.40	0.80	1	7.6	13.5	5.1	\$.51	\$.48	\$.45	\$.42
199873CD	RA050-60	0.50	1.00	1	7.9	13.7	5.1	\$.51	\$.48	\$.45	\$.42
199881CD	RA065-60	0.65	1.30	1	9.7	14.5	5.1	\$.52	\$.49	\$.46	\$.43
199890CD	RA075-60	0.75	1.50	1	10.4	15.2	5.1	\$.52	\$.49	\$.46	\$.43
199902CD	RA090-60	0.90	1.80	1	11.7	15.8	5.1	\$.53	\$.50	\$.48	\$.45
199911CD	RA110-60	1.10	2.20	2	13.0	18.0	5.1	\$.60	\$.57	\$.55	\$.46
199929CD	RA135-60	1.35	2.70	2	14.5	19.6	5.1	\$.61	\$.58	\$.56	\$.47
199937CD	RA160-60	1.60	3.20	2	16.3	21.3	5.1	\$.63	\$.59	\$.57	\$.48
199945CD	RA185-60	1.85	3.70	2	17.8	22.9	5.1	\$.65	\$.62	\$.59	\$.50
199953CD	RA250-60	2.50	5.00	2	21.3	26.4	10.2	\$.76	\$.73	\$.68	\$.53
199961CD	RA300-60	3.00	6.00	2	24.9	30.0	10.2	\$.81	\$.77	\$.72	\$.56
199970CD	RA375-60	3.75	7.50	2	28.5	33.5	10.2	\$.83	\$.78	\$.73	\$.56

Part No.	Mfr. Ref. No.	Hold Curr. (I _H , A)	Trip Curr. (I _T , A)	Fig.	Size (mm)			Pricing			
					A	B	C	1	10	100	500
199988CD	RB090-30	0.90	1.80	3	7.4	12.2	5.1	\$.52	\$.49	\$.46	\$.42
199996CD	RB110-30	1.10	2.20	3	7.4	14.2	5.1	\$.52	\$.49	\$.46	\$.42
200002CD	RB135-30	1.35	2.70	3	8.9	13.5	5.1	\$.52	\$.49	\$.46	\$.42
200011CD	RB160-30	1.60	3.20	3	8.9	15.2	5.1	\$.56	\$.53	\$.51	\$.44
200029CD	RB185-30	1.85	3.70	3	10.2	15.7	5.1	\$.59	\$.57	\$.55	\$.47
200037CD	RB250-30	2.50	5.00	3	11.4	18.3	5.1	\$.63	\$.59	\$.57	\$.48
200045CD	RB300-30	3.00	6.00	4	11.4	17.3	5.1	\$.67	\$.64	\$.62	\$.51
200053CD	RB400-30	4.00	8.00	4	14.0	20.1	5.1	\$.81	\$.75	\$.71	\$.58
200061CD	RB500-30	5.00	10.00	4	14.0	24.9	10.2	\$.85	\$.80	\$.75	\$.62
200070CD	RB600-30	6.00	12.00	4	16.5	24.9	10.2	\$.89	\$.84	\$.79	\$.61
200088CD	RB700-30	7.00	14.00	4	19.1	26.7	10.2	\$.92	\$.88	\$.83	\$.64
200096CD	RB800-30	8.00	16.00	4	21.6	29.2	10.2	\$.99	\$.92	\$.86	\$.68
200109CD	RB900-30	9.00	18.00	4	24.1	29.7	10.2	1.05	\$.98	\$.90	\$.73

Panel Mount Fuse Holders

1/4" x 1/8" Standard Thumbscrew Cap



- Straight solder terminal; 10A @ 250VAC

Part No.	Approvals	Size	Mounting Hole	1	10	100	1000
120993CD	—	1.95"L x .71" Dia.	.58" Dia.	\$.79	\$.69	\$.55	\$.49
18702CD	UL/CSA	2.05"L x .71" Dia. .58" Dia. x .52" Flat (D-style)	.52" Dia. (D-style)	1.59	1.35	1.15	.99

5mm x 20mm Miniature Thumbscrew Cap

- Straight solder terminal; Size: 1.5"L x 0.6" Dia.

Part No.	Approvals	Current	Mounting Hole	1	10	100	1000
150463CD	—	6A @ 250VAC	.50" Dia. x .43" Flat	\$.99	\$.86	\$.75	\$.57
102824CD	UL/CSA	10A @ 250VAC	.50" Dia.	\$.99	\$.85	\$.72	\$.59

Fuse Clips

- Low contact resistance
- Low profile
- Withstands shock and vibration

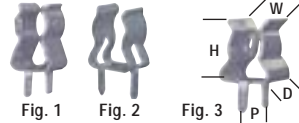

Prepackaged: order in increments of 10, 100 or 1000

Part No.	Description	Fig.	Size (H" x W" x D" x P")	10	100	1000
102859CD	5mm, front leads	1	.37 x .25 x .21 x .19	\$.12	\$.09	\$.05
119280CD	5mm, side leads	2	.33 x .25 x .20 x .21	\$.09	\$.08	\$.07
102841CD	1/4", front leads (10A)	3	.32 x .27 x .25 x .23	\$.09	\$.08	\$.07
220732CD	5mm, front leads (10A)	3	.33 x .27 x .25 x .29	\$.15	\$.10	\$.07

1/4" x 1/8" Standard Fuses

Fast Acting Fuses (250V) AGC/3AG Fuses



- Prepackaged: order in increments of 10, 100 or 1000

Part No.	Amps	Mfr.	10	100	1000
69403CD	250mA	Various	\$.20	\$.18	\$.16
10410CD	500mA	Various	.20	.18	.16
197510CD	630mA	Various	.20	.18	.16
10372CD	1 amp	Various	.20	.12	.11
197528CD	1.6 amp	Various	.20	.12	.11
10381CD	2 amp	Various	.20	.12	.11
197536CD	2.5 amp	Various	.20	.12	.11
69438CD	3 amp	Various	.20	.12	.11
197544CD	4 amp	Various	.22	.20	.18
10401CD	5 amp	Various	.22	.20	.18
197552CD	6.3 amp	Various	.22	.20	.18
69462CD	10 amp	Various	.25	.22	.20
186301CD	16 amp	Various	.25	.22	.20

Slow Blow Fuses (250V) MDL/3AG Fuses



Part No.	Amps	Mfr.	1	10	100	1000
25654CD	250mA	Various	\$.65	\$.52	\$.44	\$.34
25689CD	500mA	Various	\$.65	\$.52	\$.44	\$.34
25638CD	1 amp	Various	\$.65	\$.52	\$.44	\$.34
25646CD	2 amp	Various	\$.59	\$.53	\$.34	\$.29
69534CD	3 amp	Various	\$.59	\$.53	\$.34	\$.29
25671CD	5 amp	Various	\$.59	\$.53	\$.34	\$.29
69569CD	10 amp	Various	\$.65	\$.52	\$.44	\$.34

5mm x 20mm Miniature Fuses

Fast Acting Fuses (250V) GMA Fuses



- Recommended for new designs
- Prepackaged: order in increments of 10, 100 or 1000

Part No.	Amps	Mfr.	10	100	500	1000
103886CD	250mA	Various	\$.20	\$.15	\$.11	\$.10
102040CD	500mA	Various	\$.20	\$.15	\$.11	\$.10
103907CD	1 amp	Various	\$.20	\$.15	\$.11	\$.10
103915CD	2 amp	Various	\$.20	\$.15	\$.11	\$.10
103923CD	3 amp	Various	\$.20	\$.15	\$.11	\$.10
103931CD	5 amp	Various	\$.20	\$.15	\$.11	\$.10

Slow Blow Fuses (250V) GMA Fuses



- Prepackaged: order in increments of 10, 100 or 1000

Part No.	Amps	Mfr.	10	100	1000
197501CD	500mA	Various	\$.29	\$.26	\$.23
197464CD	1 amp	Various	\$.29	\$.26	\$.23
197472CD	2 amp	Various	\$.35	\$.32	\$.29
197481CD	3.15 amp	Various	\$.35	\$.32	\$.29
197499CD	5 amp	Various	\$.35	\$.32	\$.29

1 Amp Fuse with Pigtail



- 5mm x 20mm fuse
- 250V @ 1A
- Lead length: 1.5"
- Prepackaged: order in increments of 10 or 100

Part No.	Description	10	100
215431CD	1 Amp fuse w/ pigtail	\$.13	\$.12

In-Line Fuse Holders

- Built-in spring ensures good fuse connection
- Vinyl covered wire with stranded copper center
- Wire color: red; except for P/N 108783CD orange



1/4" x 1/8" Standard

Part No.	AWG	Wire Lgths	Body Size(L)	Color	1	10	100
109321CD	22	3.5/3"	2.4"	Black	\$.65	\$.58	\$.52
102867CD	20	3/3"	2.2"	White	\$.65	\$.58	\$.48
151917CD	18	6/6"	2.4"	White	\$.99	\$.85	\$.65
108783CD	16	21/26"	2.2"	Black	\$.99	\$.87	\$.68
108791CD	14	19/25"	2.5"	Black	1.59	1.35	1.05

5mm x 20mm Miniature

Part No.	AWG	Color	Body Size (L)	1	10	100
109330CD	20	Red	1.8"	\$.69	\$.56	\$.45

5mm x 20mm Miniature Low Profile Fuse Holder

- Accepts 5 x 20mm fuses
- 10A @ 250VAC
- Size: 1.4"L x 0.6" Dia.
- D Style mounting hole: 1 ea. 0.5" Dia x .46" flat

Part No.	Description	1	10	100
102832CD	Fuse holder UL/CSA	\$.195	\$.179	\$.159

LED Displays

The general advantages of LED displays compared to incandescent types include:

- Lower power consumption
- Longer lifetime (averaged more than 300,000 hours)
- Compact size suitable for instrumentation and graphic representations

Soldering:

- Soldering bath: not more than 5 seconds @ 260°C
- Soldering iron: not more than 3 seconds @ 300°C under 30W

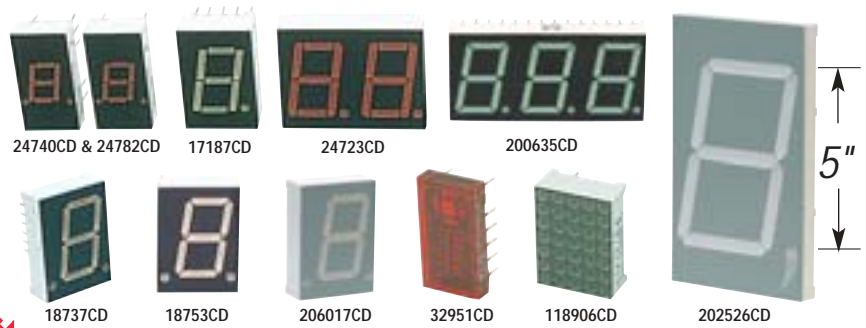

7-Segment Displays

Part No.	Mfr. Cross Reference No.	Character Height	Illuminated Color	Buss Polarity*	Pins/Leads	Typical Vf @ If (mA)	Typical mcd @ mA	Wavelength nm	Decimal Point #	Pricing			
										1	10	100	1000
24731CD	LSD3021-11	.300"	Red	CA	11	1.9 @ 20	0.3 @ 20	697	RHDP	\$.95	\$.76	\$.68	\$.61
24740CD	LSD3221-11	.300"	Red	CA	11	2.1 @ 20	2.5 @ 20	697	LHDP	.79	.72	.64	.58
151976CD	LTS312AY	.300"	Yellow	CA	11	2.8 @ 20	2.0 @ 10	585	LHDP	.89	.75	.65	.49
24782CD	LSD3211-11	.300"	Red	CC	10	2.1 @ 20	2.5 @ 20	697	RHDP	.89	.75	.65	.49
17187CD	LSD5051-11	.500"	Red	CC	10	2.1 @ 20	0.9 @ 20	697	RHDP	.89	.80	.72	.65
17208CD	LSD5061-11	.500"	Red	CA	10	2.1 @ 20	0.9 @ 20	697	RHDP	.89	.75	.65	.49
104213CD	LSD5124-10	.560"	Orange Red	CA	10	2.0 @ 20	2.4 @ 20	635	RHDP	.89	.80	.71	.55
199531CD	LSD5111-11	.560"	Red	CC	10	2.1 @ 20	0.8 @ 20	697	RHDP	.99	.89	.79	.72
24715CD	LDD5121-20	.560"	Red	2-digit CA	18	2.1 @ 20	0.8 @ 20	697	RHDP	1.25	1.05	.89	.75
24723CD	LDD5111-11	.560"	Red	2-digit CC	18	2.1 @ 20	0.8 @ 20	697	RHDP	1.25	1.05	.89	.75
200379CD	LB602VAGI	.560"	Red	2-digit CA	18	2.0 @ 10	16 @ 10	650	RHDP	1.39	1.25	1.05	.75
24694CD	LDD5124	.560"	Orange Red	2-digit CA	18	2.0 @ 20	2.4 @ 20	635	RHDP	1.55	1.45	1.15	.85
24707CD	LDD5114-20	.560"	Orange Red	2-digit CC	18	2.0 @ 20	2.4 @ 20	635	RHDP	1.35	1.15	.99	.89
200539CD	ELD556YWA	.560"	Yellow	2-digit CA	18	2.0 @ 20	1.9 @ 10	590	RHDP	1.25	1.15	.89	.65
225963CD	KW3-562A2B	.560"	Green	3-digit CA	28	2.2 @ 20	15 @ 20	568	RHDP	2.39	2.15	1.95	1.25
199582CD	LC56311	.560"	Yellow	CC	8	2.1 @ 20	5.2 @ 20	589	RHDP	1.49	1.34	1.19	.99
196787CD	LB602VA	.560"	Orange Red	2-digit CA	18	2.0 @ 20	16.0 @ 20	650	RHDP	1.59	1.45	1.15	.85
18737CD	LSD816-11	.800"	Orange Red	CA	13	1.6 @ 20	0.9 @ 20	655	RHDP	1.45	1.20	.99	.74
18753CD	LSD8151-10	.800"	Red	CC	13	2.1 @ 20	1.0 @ 20	697	RHDP	1.49	1.35	1.19	.99
206017CD	SC08-11HWA	.800"	Red	CC	13	2.0 @ 20	.36 @ 10	700	RHDP	1.49	1.35	1.19	.94
176559CD	C8021-1	.800"	Green	CC	13	2.0 @ 20	0.9 @ 20	568	RHDP	.49	.42	.37	.33
97172CD	LSD10061-10	1.0"	Red	CA	10	2.1 @ 20	2.0 @ 20	697	RHDP	1.39	1.25	1.12	.99
97199CD	LSD23265-10	2.24"	Red	CA	10	1.7 @ 20	21 @ 20	660	RHDP	5.75	5.19	4.69	4.19
97201CD	LSD23255-10	2.24"	Red	CC	10	1.7 @ 20	21 @ 20	660	RHDP	4.49	3.95	3.25	2.95
202518CD	LSD30165-20	3.0"	Orange Red	CA	10	8 @ 20	4.5 @ 10	635	RHDP	7.39	6.99	6.65	6.29
202542CD	LSD30155-20	3.0"	Orange Red	CC	10	8 @ 20	4.5 @ 10	635	RHDP	5.95	5.35	4.82	4.34
105591CD	LSD40054-20†	4.0"	Orange Red	CC	10	2.0 @ 20	18 @ 20	635	RHDP	9.49	8.29	7.49	6.49
202500CD	LSD40064-20	4.0"	Orange Red	CA	10	2.0 @ 20	18 @ 10	635	RHDP	10.49	9.49	8.59	7.79
202526CD	LSD50065-20	5.0"	Red	CA	10	17 @ 20	45 @ 10	660	RHDP	34.99	27.89	25.29	22.79
202534CD	LSD50055-20	5.0"	Red	CC	10	17 @ 20	45 @ 10	660	RHDP	17.95	14.35	12.95	11.65

† 5 diodes per segment

Dot Matrix Displays

Part No.	Mfr. Cross Reference No.	Jameco Socket Number	Character Height	Illuminated Color	Buss Polarity*	Pins/Leads	Typical Vf @ If (mA)	Typical mcd @ mA	Wavelength nm	Decimal Point #	Pricing			
											1	10	100	1000
173833CD	HP5082-7300	—	.290"	Red	4x7 Numeric	8	5.0 @ 170	.03 @ 20	660	RHDP	\$7.95	\$7.19	\$5.75	\$4.25
32951CD	TIL311	37161	.300"	Red	4x7 Hex character	11	5.0 @ 5	0.1 @ 5	660	—	16.95	14.35	12.92	11.62
118906CD	LTP747R	37161	.680"	Orange Red	5 x 7 AC/CR	12	1.7 @ 20	0.2 @ 20	655	—	1.95	1.79	1.45	1.05
218843CD	CSM57041T-11	—	.700"	Red	5 x 7 CC/AR	12	1.8 @ 20	8 @ 20	660	—	1.95	1.55	1.17	.82
206560CD	LTP2157AG	—	2.0"	Green	5 x 7 CC/AR	14	3.7 @ 80	4.8 @ 80	565	—	4.95	4.49	3.95	3.59
183265CD	LMDS821ASR-20	—	2.3"	Red	5 x 8 CC/AR	14	1.7 @ 20	12 @ 20	660	—	4.95	4.49	3.95	3.49

* CA-Common Anode/CC-Common Cathode/AC-Anode Column/CR-Cathode Row/AR-Anode Row # LHDP-Left Hand Decimal Point / RHDP-Right Hand Decimal Point



Cluster-Type T1^{3/4} LED Lamps

- Cluster-type red/green T1^{3/4} LEDs
- 660nm for red/570nm for green
- Lens: water clear • Common anode • 3 lead wires

150914CD: 50 Cluster (30 green/20 red)

150922CD: 14 Cluster (8 green/6 red)

150914CD



Part No.	Product No.	Vf @ If	mcd @ mA	Lead Wire	Mounting Hole Dia.	Dimensions (Dia." x L")	Pricing		
							1	10	100
150922CD	LCR2614B-79	10V @ 20mA	1950 @ 20	7"	M3	1.02 x 1.51	\$4.95	\$4.49	\$3.95
150914CD	LCR5250A-79	20.5V @ 40mA	12,000 @ 40	16"	M4	2.07 x 1.98	21.95	19.95	17.95



Phone 1-800-831-4242
Online www.Jameco.com

Order Anytime 24x7x365

Fax 1-800-237-6948

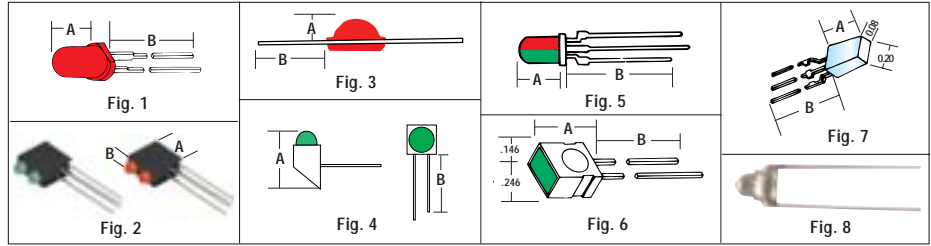
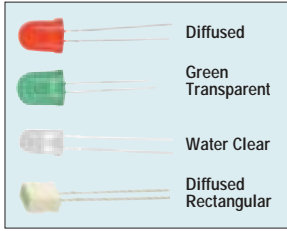

Standard-Output LEDs

Call for OEM PRICING – we carry major manufacturers.

Prepackaged: order in increments of 100 or 1000
 * Prepackaged: order in increments of 10, 100 or 1000

Part No.	Mfr. Cross Ref. No.	Fig.	Emitting Color	Lens/Feature Description	LED Size	Diameter inch/mm	Dimensions		Lead Spacing	Typical Vf @ If (mA)	Typical mcd @ mA	Wavelength nm	Pricing			
							A*	B*					1	10	100	1000
206480CD	LVY2041	1	Yellow	Yellow transparent	T1	.119/3	0.17	0.69	0.08	2.3 @ 20	375 @ 20	595	*	\$.15	\$.12	\$.09
136493CD	LTO333-41	1	Yellow	Water clear (BY209)	T1	.119/3	0.20	0.95	0.10	2.1 @ 20	19 @ 20	585	*	.19	.11	.09
202489CD	MVL-301Y	1	Yellow	Yellow diffused	T1	.119/3	0.14	1.12	0.10	2.1 @ 20	9.0 @ 10	585	*	.19	.15	.12
34657CD	LY2040	1	Yellow	Yellow diffused (XC209Y)	T1	.119/3	0.16	0.68	0.08	2.8 @ 20	6.5 @ 10	585	*	.17	.13	.10
206498CD	LR2041	1	Red	Red transparent	T1	.119/3	0.17	0.69	0.08	2.1 @ 20	280 @ 20	660	*	.15	.12	.09
114673CD	LH2043	1	Red	Water clear (BR209)	T1	.119/3	0.14	0.98	0.07	2.8 @ 20	15 @ 15	697	*	.19	.15	.12
94529CD	LH2040	1	Red	Red diffused (XC209RB)	T1	.119/3	0.18	1.04	0.07	2.0 @ 20	2.7 @ 20	700	*	.19	.15	.12
175679CD	LTL-232	1	Green	Green transparent	T1	.119/3	0.17	0.69	0.08	2.2 @ 20	170 @ 20	565	*	.15	.12	.09
114681CD	LVG2043	1	Green	Water clear (BG209)	T1	.119/3	0.14	0.98	0.07	2.8 @ 20	22 @ 2	563	*	.19	.15	.12
34606CD	LSG2040	1	Green	Green diffused (XC209G)	T1	.119/3	0.13	1.05	0.08	2.8 @ 20	15 @ 10	560	*	.15	.13	.095
211086CD	LTL-4231N-022	1	Green	Green diffused	T1	.119/3	0.13	1.10	0.10	2.1 @ 20	12.6 @ 10	565	#	#	.09	.07
202471CD	MVL-301HR	1	Orng Red	Red diffused	T1	.119/3	0.14	1.12	0.10	2.0 @ 20	9.0 @ 10	640	*	.19	.15	.12
34622CD	LR2040	1	Orng Red	Red diffused (XC209R)	T1	.119/3	0.14	1.09	0.09	2.0 @ 20	1.5 @ 10	655	*	.15	.13	.095
94553CD	LHG2062	1	Red/Green	White diffused bi-color/bi-state ¹	T1	.119/3	0.18	1.06	0.08	2.8 @ 20	3 & 15 @ 10	697/565	*	.22	.19	.15
137411CD	LVB2040	1	Blue	Blue diffused	T1	.119/3	0.21	0.98	0.10	5.5 @ 20	7.0 @ 20	430	2.49	2.25	1.95	1.69
123941CD	521-9478	1	Green/Yellow	White diffused bi-color/bi-state ¹	T1	.119/3	0.18	0.86	0.08	2.6 @ 10	5.0 @ 10	565/585	*	.29	.19	.15
203553CD	HLMP-4100	1	Orange Red	Water clear	T1 3/4	.197/5	0.33	1.07	0.08	1.8 @ 20	750 @ 20	637	.29	.25	.20	.15
210825CD	BVU-5MIQN1	1	Orange Red	Red diffused	T1 3/4	.197/5	0.30	1.07	0.08	2.1 @ 20	600 @ 20	615	.49	.45	.39	.35
135597CD	LTL307E	1	Orange Red	Red diffused	T1 3/4	.197/5	0.34	1.00	0.07	2.8 @ 20	19 @ 10	635	*	.19	.15	.12
107393CD	LE3330	1	Orange Red	Orange diffused (XC556A)	T1 3/4	.197/5	0.30	1.02	0.08	2.8 @ 20	12 @ 20	635	*	.17	.13	.10
34796CD	LR3330	1	Orange Red	Red diffused (XC556R)	T1 3/4	.197/5	0.30	0.62	0.08	2.0 @ 20	1.5 @ 10	655	*	.15	.12	.08
206501CD	LVY3331	1	Yellow	Yellow transparent	T1 3/4	.197/5	0.24	1.07	0.07	2.3 @ 20	725 @ 20	595	*	.19	.15	.12
175695CD	LTL-425B	1	Yellow	Water clear	T1 3/4	.197/5	0.30	1.07	0.08	2.2 @ 20	550 @ 20	595	*	.19	.15	.12
34825CD	LY3330	1	Yellow	Yellow diffused (XC556Y)	T1 3/4	.197/5	0.30	0.82	0.07	2.8 @ 20	15 @ 10	585	*	.19	.15	.12
206519CD	LHR3331	1	Red	Red transparent	T1 3/4	.197/5	0.24	1.07	0.07	2.0 @ 20	725 @ 20	660	*	.19	.15	.12
11797CD	HPQLMPD141	1	Red	Water clear (BR5704)	T1 3/4	.197/5	0.29	1.05	0.07	2.0 @ 20	350 @ 20	660	*	.19	.15	.11
138860CD	LTH3363	1	Red	Water clear/flashing [†]	T1 3/4	.197/5	0.35	1.06	0.10	3-15 @ 20	7.5 @ 20	697	.49	.45	.39	.29
34745CD	LH3333	1	Red	Water clear (XC554R)	T1 3/4	.197/5	0.30	1.00	0.08	2.8 @ 20	7.5 @ 10	697	*	.15	.11	.065
94511CD	LH3330	1	Red	Red diffused (XC556RB)	T1 3/4	.197/5	0.31	0.81	0.08	2.8 @ 10	4.0 @ 10	697	*	.17	.13	.10
34690CD	LFH3360	1	Red	Red diffused/flashing (XC5410)	T1 3/4	.197/5	0.30	0.94	0.07	1.2 @ 20	2.8 @ 20	697	.49	.45	.39	.35
134332CD	LT18B3-81UR	1	Blue	Water clear	T1 3/4	.197/5	0.30	0.93	0.10	5.0 @ 20	630 @ 20	428	2.65	2.45	2.25	1.95
137613CD	LSB3333	1	Blue	Water clear	T1 3/4	.197/5	0.34	0.98	0.08	5.5 @ 20	190 @ 20	430	2.49	2.25	1.95	1.75
138691CD	LVB3330	1	Blue	Blue diffused	T1 3/4	.197/5	0.34	0.98	0.08	5.5 @ 20	10 @ 20	430	2.49	2.25	1.95	1.75
153154CD	LVG3333	1	Green	Water clear	T1 3/4	.197/5	0.36	0.90	0.10	2.2 @ 20	300 @ 20	568	*	.19	.15	.12
11359CD	LG3333	1	Green	Water clear (BG5704)	T1 3/4	.197/5	0.30	1.04	0.07	2.1 @ 20	40 @ 20	555	*	.19	.17	.14
175687CD	LTO524-81	1	Green	Green transparent	T1 3/4	.197/5	0.24	1.07	0.07	2.0 @ 20	40 @ 20	555	*	.18	.15	.09
94561CD	LFG3360	1	Green	Green diff./flashing (XC5408)	T1 3/4	.197/5	0.30	1.05	0.08	1.2 @ 20	17 @ 20	565	.59	.53	.48	.43
34761CD	LG3330	1	Green	Green diffused (XC556G)	T1 3/4	.197/5	0.31	0.79	0.09	2.8 @ 20	12 @ 10	565	*	.15	.14	.10
34711CD	LEG3362	1	Red/Green	White diffused bi-color/bi-state ¹	T1 3/4	.197/5	0.30	1.01	0.09	2.8 @ 20	7.5 & 8 @ 20	635/565	.35	.29	.25	.19
119634CD	LHR3930	1	Red	Red diffused Jumbo	T2 1/2	.315/8	0.44	0.84	0.07	2.4 @ 20	100 @ 20	660	.25	.21	.15	.14
137621CD	LVG3930	1	Green	Green diffused Jumbo	T2 1/2	.315/8	0.43	1.04	0.07	1.7 @ 20	40 @ 20	565	.25	.21	.15	.13
138683CD	LHR3630	1	Red	Red diffused XJumbo (XC10R)	T3 1/4	.394/10	0.40	1.04	0.10	1.5 @ 20	200 @ 20	660	.29	.26	.22	.18
98984CD	LVG3630	1	Green	Green diffused XJumbo (XC10G)	T3 1/4	.394/10	0.40	1.07	0.08	2.8 @ 20	40 @ 20	565	.28	.25	.19	.14
98992CD	LY3630	1	Yellow	Yellow diff. XJumbo (XC10Y)	T3 1/4	.394/10	0.54	1.04	0.08	2.1 @ 20	8.0 @ 20	585	.29	.25	.19	.15
136274CD	LA44B/2G	2	Green	Green diffused (dual)	T1	.119/3	0.38	0.17	0.10	2.3 @ 20	20 @ 10	565	.49	.45	.39	.29
136282CD	LA44B/2I	2	Red	Red diffused (dual)	T1	.119/3	0.38	0.17	0.10	2.3 @ 20	6.2 @ 10	630	.49	.45	.39	.29
206375CD	LA129B/2LG	2	Green	Green diffused (dual)	T1	.119/3	0.39	0.18	0.10	2.3 @ 20	12 @ 10	565	.49	.45	.39	.29
206383CD	LA129B/2LR	2	Red	Red diffused (dual)	T1	.119/3	0.39	0.18	0.10	2.3 @ 20	3.5 @ 10	697	.49	.45	.39	.29
26745CD	MV50	3	Red	Water clear	T 3/4	.083/2.1	0.06	0.25	0.11	1.7 @ 20	1.4 @ 20	660	.39	.35	.29	.20
134869CD	RRL5621	3	Orange Red	Red diffused (5V) [†]	T 3/4	.083/2.1	0.09	0.37	0.10	5.0 @ 8	1.2 @ 8	650	*	.19	.15	.12
104248CD	LA93B/H-1	4	Red	Red diffused (XC410R)	T1 3/4	.197/5	0.35	0.89	0.08	2.8 @ 20	6.5 @ 10	697	*	.23	.19	.17
104256CD	LA93B/G-1	4	Green	Green diffused (XC410G)	T1 3/4	.197/5	0.35	0.89	0.08	2.2 @ 20	6.0 @ 10	570	*	.23	.19	.17
104264CD	LA93B/Y-1	4	Yellow	Yellow diffused (XC410Y)	T1 3/4	.197/5	0.35	0.89	0.08	2.8 @ 20	2.5 @ 10	585	.35	.29	.25	.19
34673CD	LHG3392	5	Red/Green	White diff. bi-color/tri-state ¹	T1 3/4	.197/5	0.30	1.02	0.03	2.8 @ 20	3 & 12 @ 10	697/565	.29	.25	.19	.15
34850CD	LT7341R-81*	6	Orange Red	Red diffused rectangular	3.5 x 6	—	0.27	0.85	0.07	2.0 @ 20	10.1 @ 20	635	.39	.35	.31	.24
94545CD	LG25030*	6	Green	Green diff. rect. (XC57124G)	3.5 x 6	—	0.26	1.06	0.08	2.2 @ 20	5.0 @ 20	565	.39	.35	.29	.20
104889CD	LEG5292*	7	Red/Green	White diff. bi-color rectangular	2 x 5	—	0.27	1.02	0.08	2.2 @ 20	3.5/6 @ 10	695/570	*	.17	.13	.10
176532CD	MV50G	8	Green	Water clear	T 3/4	.069/1.7	0.06	0.40	0.08	2.1 @ 20	300 @ 20	568	*	.10	.08	.06

¹ Reverse polarity to change color

[†] Has internal current limiting resistor

* For Mounting Hardware see page 96

High-Output LEDs

SALE

See page 96 for LED Mounting Hardware

• Typical DC forward current 20mA

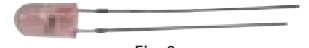
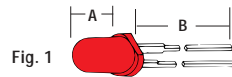

Fig. 2

Part No.	Mfr. Cross Reference No.	Fig.	Emitting Color	Lens/Feature Description	LED Size	Diameter inch/mm	Dimensions		Lead Spacing	Typical Vf @ If (mA)	Typical mcd @ mA	Wavelength nm	Pricing			
							A"	B"					1	10	100	1000
217525CD	MCDPW-3004C	1	White	Water clear	T1	.119/3	0.18	1.00	0.10	3.8 @ 20	3000 @ 20	—	\$2.99	\$2.85	\$2.69	\$2.55
142893CD	CLP1509	1	White	Water clear	T1 3/4	.197/5	0.34	0.79	0.08	3.6 @ 20	3700 @ 20	—	3.95	3.59	2.95	2.75
183231CD	T18W133196	1	White	Water clear	T1 3/4	.197/5	0.30	1.06	0.08	3.6 @ 20	3000 @ 20	—	2.95	2.65	2.39	2.15
183222CD	MCDL513SBC4	1	Blue	Water clear	T1 3/4	.197/5	0.29	1.02	0.08	5.0 @ 20	3000 @ 20	470	3.25	2.95	2.65	2.39
183214CD	MCDPG503PCI	1	Green	Water clear	T1 3/4	.197/5	0.30	1.04	0.08	3.5 @ 20	2200 @ 20	515	2.95	2.65	2.39	2.15
131895CD	TLSH180P	1	Orange	Water clear	T1 3/4	.197/5	0.39	0.80	0.10	2.1 @ 20	7000 @ 20	623	2.49	2.19	1.95	1.79
153138CD	LT2KJ3-UR-S14	1	Orange	Water clear	T1 3/4	.197/5	0.36	0.90	0.10	2.1 @ 20	2500 @ 20	621	.39	.35	.29	.25
197683CD	BVT5E1QT4ER	1	Orange Red	Water clear	T1 3/4	.197/5	0.29	1.08	0.08	2.3 @ 20	4650 @ 20	634	.69	.59	.49	.39
197616CD	BVU5E1QH4E	1	Red	Water clear	T1 3/4	.197/5	0.30	1.05	0.08	1.8 @ 20	2180 @ 20	630	.39	.35	.29	.25
215597CD	LT2K33-81-UC9T	1	Yellow	Water clear	T1 3/4	.197/5	0.31	0.89	0.10	2.2 @ 20	5000 @ 20	590	.59	.55	.49	.45
197675CD	BVT5E1TT4E	1	Yellow	Water clear	T1 3/4	.197/5	0.30	1.08	0.08	2.3 @ 20	2800 @ 20	592	.69	.62	.55	.49
197641CD	BVT529T13E	2	Yellow	Yellow transparent	Oval	.170/.220	0.29	1.04	0.08	2.3 @ 20	7800 @ 20	590	.69	.62	.55	.49
197659CD	BVT529QT3F	2	Orange Red	Red transparent	Oval	.170/.220	0.30	1.05	0.08	2.3 @ 20	3600 @ 20	629	.69	.62	.55	.49

LEDTECH LEDs

• Typical DC forward current 20mA

Ledtech is a QS9000 and ISO-9000 Certified Company

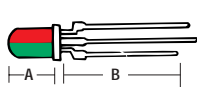

Fig. 1

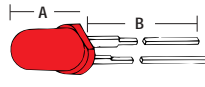
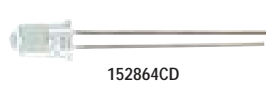

Fig. 2



152864CD



151415CD

* Prepackaged: order in increments of 10, 100 or 1000

Part Number	Product Number	Fig.	Emitting Color	Lens/Feature Description	LED Size	Diameter (in./mm)	Dimensions		Lead Spacing	Typical Vf @ If (mA)	Typical mcd @ mA	Wavelength nm	Pricing			
							A"	B"					1	10	100	1000
156970CD	LT1873-UR-C07	2	Red Ultra Bright	Water clear (wide angle)	T1 3/4	.197/5	0.34	0.89	0.10	1.9 @ 20	2112 @ 20	660	\$.35	\$.31	\$.25	\$.19
152805CD	LT1873-81-UR	2	Red Ultra Bright	Water clear	T1 3/4	.197/5	0.34	0.89	0.10	1.9 @ 20	600 @ 20	660	.29	.25	.19	.15
152864CD	LT1873-81	2	Red Super Bright	Water clear	T1 3/4	.197/5	0.34	0.89	0.10	1.7 @ 20	1000 @ 20	660	.29	.24	.19	.15
156953CD	LT0373-41	2	Red Super Bright	Water clear	T1	.119/3	0.21	1.07	0.08	1.7 @ 20	600 @ 20	660	.25	.19	.15	.12
156945CD	LT0362-25-D61	1	Red/Green	White diff. bi-color tri-state	T1	.119/3	0.16	0.87	0.08	2.1 @ 20	14/3 @ 20	700/567	.29	.25	.19	.15
152750CD	LT0344R-41	2	Orange Red	Red clear	T1	.119/3	0.20	0.89	0.10	2.1 @ 20	23.5 @ 10	635	*	.19	.16	.12
152784CD	LT0341R-41	2	Orange Red	Red diffused	T1	.119/3	0.20	0.89	0.10	2.1 @ 20	6.9 @ 10	635	*	.17	.15	.12
152856CD	LT1841R-81	2	Orange Red	Red diffused	T1 3/4	.197/5	0.34	0.89	0.10	2.1 @ 20	23 @ 20	635	*	.17	.15	.13
152768CD	LT0324-41	2	Green	Green clear	T1	.119/3	0.20	0.89	0.10	2.1 @ 20	20 @ 20	567	*	.17	.14	.11
156929CD	LT0321-41-HE	2	Green	Green diffused	T1	.118/3	0.16	0.88	0.10	2.1 @ 20	13.3 @ 20	567	*	.18	.11	.10
156961CD	LT1823-81-HE	2	Green	Water clear	T1 3/4	.197/5	0.34	0.87	0.10	2.2 @ 20	500 @ 20	567	*	.19	.17	.14
152821CD	LT1821-81-HE	2	Green	Green diffused	T1 3/4	.197/5	0.34	0.89	0.10	2.2 @ 20	100 @ 20	567	*	.17	.11	.09
152792CD	LT1833-81M1	2	Ylw Super Bright	Water clear	T1 3/4	.197/5	0.34	0.89	0.10	2.1 @ 20	420 @ 20	595	.29	.25	.19	.15
152830CD	LT1831-81UR	2	Ylw Ultra Bright	Yellow diffused	T1 3/4	.197/5	0.34	0.89	0.10	2.1 @ 20	400 @ 20	595	.39	.35	.29	.25
156937CD	LT0331-41	2	Yellow	Yellow diffused	T1	.118/3	0.16	0.88	0.10	2.1 @ 20	11 @ 20	585	*	.17	.14	.11
White Diffused Backlight																
151415CD	LTIF24-A2-S1	-	Green	Backlight, white diffused	2.05" L x 0.78" H x 0.09" T				8-pin	6.0 @ 20	6.0 @ 20	567	\$2.95	\$2.65	\$2.39	\$1.95

Infrared and Visible Light Emitters and Detectors

• Use for remote control and/or for fiber optics
 • P/N 133946CD:
 Can be used with cameras,
 see pgs 196-198 (peak emission
 wavelength: 940nm @ If 20mA)

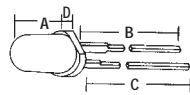

Fig. 1

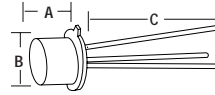

Fig. 2

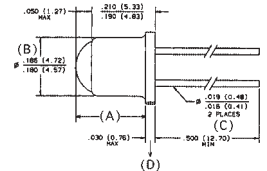
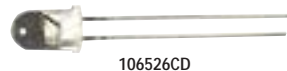

Fig. 3

SALE



106526CD



172321CD

Part No.	Mfr. Cross Ref. No.	Fig.	Description	Size	Diameter inch/mm	Dimensions (inches)				Vf @ If	nm	mWatts	Pricing			
						A	B	C	D				1	10	100	1000
112150CD	TLN100	1	Infrared emitter diode (GaAs)	T1	0.125/3	0.18	0.95	0.98	0.03	1.2V @ 20mA	940	1.2	\$.64	\$.19	\$.14	\$.12
133946CD	SLI-0308CP	1	Infrared emitter diode (GaAs)	T1	0.12/3	0.22	0.98	1.00	0.03	1.7V @ 50mA	940	200	\$.29	.59	.45	.35
112176CD	IRD300	1	Infrared phototransistor	T1	0.12/3	0.18	0.95	0.98	0.03	—	940	—	.39	.29	.19	.15
106526CD	TLN110	1	Infrared emitter diode (GaAs)	T1 3/4	0.200/5	0.34	0.78	0.84	0.04	1.2V @ 20mA	940	9	.39	.29	.19	.15
112168CD	IRD500	1	Infrared phototransistor	T1 3/4	0.200/5	0.31	1.05	1.10	0.04	—	940	—	.39	.36	.28	.23
120221CD	BPW77	2	Visible light phototransistor	TO-18	—	.24	0.19	0.52	—	—	800	—	1.95	1.75	1.49	1.39
172321CD	OP133	3	Infrared emitter diode (GaAs)	TO-46	—	0.22	0.18	1.05	0.20	1.8V @ 100mA	935	5	2.25	1.95	1.75	1.49

LED Mounting Hardware

• P/N 95521CD: for use with P/N 94545CD and 34850CD, pg 94



Part No.	Mfr. Cross Ref. No.	Description	Color	Mounting Hole Dia.	Panel Thickness	Pricing		
						10	100	1000
95513CD	LMH100	T1 snap-in	Black	.185"	Up to .070"	\$.08	\$.07	\$.04
23077CD	LMH200	T1 1/4 ring & clip	Black	.257"	Up to .125"	.15	.135	.12
95521CD	LMH250	Rect. snap-in	Black	.306" x .202"	Up to .092"	.20	.18	.16

T1 3/4 Cliplite® LED Lens Mount

- Requires no assembly tools, just snap in
- Material: lens – polycarbonate; spacer – nylon
- Increases viewing angle to 180°
- Devices mount on .375" centers
- Helps guard against electrostatic discharge up to 16kV while affording the LED physical protection



Part No.	Product No.	Description	Color	Fig.	Mounting Hole Dia.	Panel Thickness	Pricing			
							1	10	100	1000
14277CD	CLF280CTP	T1 3/4	Clear	1	.25"	.063" – .125"	\$.24	\$.21	\$.18	\$.15
29612CD	CLF280RTP	T1 3/4	Red	1	.25"	.063" – .125"	.25	.22	.19	.17
124927CD	CLB300CTP	T1 3/4	Clear	2	.25"	.031" – .25"	.24	.21	.18	.15

T1 & T1 3/4 Cliplite® Lens and Conxrite® Cable Assembly

Cliplite® Lens: • Material: (lens) polycarbonate; (ring) polypropylene (UL Listed)
• Mounts through front panel in 0.171" hole diameter, panel thickness: 1/32" to 3/32"

Conxrite® Cable Assembly: • Terminals: phosphor bronze, tin-plated
• Connector socket and ring/header connector: thermoplastic (UL Listed)
• Wire: 22AWG, 7 strand copper, insulated

SALE

Part No.	Product No.	Size	Description	1	10	100	1000
143183CD	SMC170CTP	T1	Clear Cliplite® lens	\$.25	\$.22	\$.18	\$.12
143132CD	CMC321CTP	T1 3/4	Clear Cliplite® lens	.25	.22	.19	.16
143087CD	BE2108	T1	8.5" cable assembly	1.25	1.13	.93	.86
143036CD	CE2108	T1 3/4	8.5" cable assembly	1.29	1.25	1.19	1.15
143052CD	CE2118	T1 3/4	18" cable assembly	1.75	1.59	1.39	1.25

LED Panel-Mount Indicators

- Easy panel installation
- Panel/status/ instrument indicators
- Vf @ If: 2V @ 20mA
- Color: red
- Chrome housing

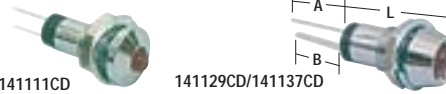

Part No.	Mfr. Cross Ref. No.	LED Size	Dimensions (in.)			Mounting Hole	Pricing			
			L	A	B		1	10	100	1000
141111CD	L922SRD	T1	.56	.34	.25	.23"	\$.79	\$.65	\$.55	\$.45
141129CD	L913RD	T1	.56	.39	.32	.24"	1.09	.85	.79	.69
141137CD	L917RD	T1 3/4	.70	.55	.47	.31"	.89	.79	.71	.55

JKL Single-Lead Tipless-Type Fluorescent Lamps

World's smallest fluorescent and ultra violet lamps. Assure you of bright, uniform output, long-life, cool operation and unmatched reliability.



142244CD: Compatible with P/N 146190CD (below)
• Lamp current: 5.0mA
• Starting voltage: 390Vrms
• Lamp voltage: 170Vrms • Intensity: 3500cd/m²

146165CD: Compatible with P/N 142252CD (below)
• Lamp current: 5.0mA
• Starting voltage: 1200Vrms
• Lamp voltage: 520Vrms
• Intensity: 28,000cd/m²

Part No.	Size (Ins.)	1	10	25
142244CD	2.0"L x 0.25"Dia. ...	\$13.95	\$12.49	\$10.95
146165CD	10.0"L x 0.12"Dia.	13.95	12.49	10.95

JKL Fluorescent Lamp Power Supplies

These DC inverters are designed especially for cold cathode fluorescent lamps.

- **146190CD:**
• Output voltage: 600Vrms @ 4mA, 30kHz
• Input voltage: 5VDC @ 200mA
• PCB size: 1.7"L x 0.8"W x 0.04"H
- **142252CD:**
• Output voltage: 850Vrms @ 5.5mA, 20kHz
• Input voltage: 12VDC @ 260mA
• PCB size: 1.8"L x 0.8"W x 0.04"H

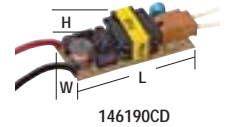

Part No.	Product No.	1	10	25
146190CD	65010	\$14.95	\$13.45	\$11.99
142252CD	12200	15.95	14.49	12.95

Incandescent and Neon Panel Mount Indicators

Incandescent Panel Mount Lamps

- 215781CD/215790CD/215773CD: wire length - 3.9" (100mm)
- 215749CD/215757CD/215765CD: wire length - 4.9" (125mm)
- 215714CD/215722CD/215731CD: solder terminals - 0.196" (5mm)



Part No.	Product No.	Fig.	Volts	Color	Mounting Hole	Pricing		
						1	10	100
215773CD	R9-46B-W100-12V-R	1	12	Red	1/2" (13mm)	\$1.79	\$1.59	\$1.35
215781CD	R9-46B-W100-12V-Y	1	12	Yellow	1/2" (13mm)	1.79	1.59	1.35
215790CD	R9-46B-W100-12V-G	1	12	Green	1/2" (13mm)	1.79	1.59	1.35
215749CD	R9-55B-W130-12V-R	2	12	Red	9/32" (7mm)	1.79	1.59	1.35
215757CD	R9-55B-W130-12V-Y	2	12	Yellow	9/32" (7mm)	1.79	1.59	1.35
215765CD	R9-55B-W130-12V-G	2	12	Green	9/32" (7mm)	1.79	1.59	1.35
215714CD	R9-71B-05-12V-R	3	12	Red	5/8" (16mm)	1.79	1.59	1.35
215722CD	R9-71B-05-12V-Y	3	12	Yellow	5/8" (16mm)	1.79	1.59	1.35
215731CD	R9-71B-05-12V-G	3	12	Green	5/8" (16mm)	1.79	1.59	1.35

Neon Panel Mount Lamps

- Output voltage: 120V
- Mounting hole diameter: 5/8" (16mm)
- Solder terminals: 0.196" (5mm)

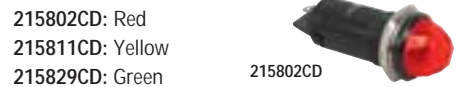

Part No.	Product No.	1	10	100
215802CD	R9-71N-05-120V-R	\$1.79	\$1.59	\$1.35
215811CD	R9-71N-05-120V-Y	1.79	1.59	1.35
215829CD	R9-71N-05-120V-G	1.79	1.59	1.35

30-Day Money-Back Guarantee

If you're not completely satisfied, we'll take it back!

Details on page 217.

Incandescent and Neon Lamps

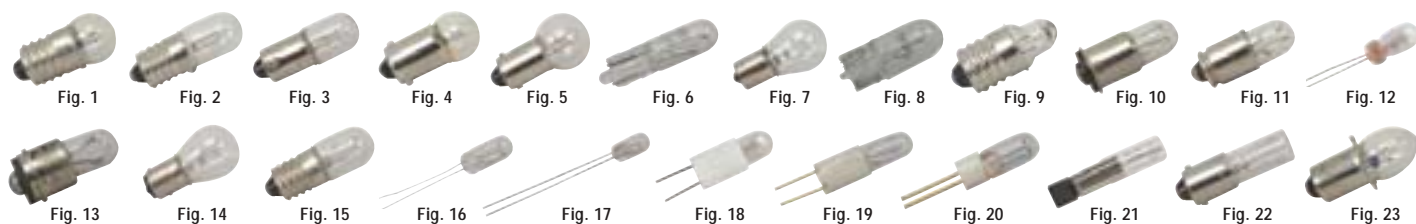

Incandescent Lamps

Part No.	Mfr. Cross Ref. No.	Fig.	Description	Volts (VDC)	Current (A)	MSCP	Pricing		
							1	10	100
209381CD	13	1	G3 1/2 miniature screw	3.7	.30	.98	\$.79	\$.69	\$.59
209390CD	14	1	G3 1/2 miniature screw	2.47	.30	.50	.55	.50	.45
209402CD	40	2	T3 1/4 miniature screw	6.3	.15	.50	.29	.19	.15
209411CD	44	3	T3 1/4 miniature bayonet	6.3	.25	.90	.29	.20	.15
209429CD	46	2	T3 1/4 miniature screw	6.3	.25	.90	.37	.32	.27
209437CD	47	3	T3 1/4 miniature bayonet	6.3	.15	.50	.29	.20	.15
209445CD	50	1	G3 1/2 miniature screw	7.5	.22	1.0	.64	.57	.51
210403CD	51	4	G3 1/2 miniature bayonet	7.5	.22	1.0	.35	.29	.25
209453CD	53	4	G3 1/2 miniature bayonet	14.4	.12	1.0	.50	.41	.35
210411CD	55	5	G4 1/2 miniature bayonet	7.0	.41	2.0	.29	.25	.19
209461CD	73	6	T1 3/4 wedge	14.0	.08	.30	.29	.21	.17
209470CD	85	6	T1 3/4 wedge	28.0	.04	.30	.29	.21	.17
209488CD	86	6	T1 3/4 wedge	6.3	.20	.40	.29	.21	.17
209496CD	93	7	S-8 sngl contact bayonet	12.8	1.04	15.0	.75	.63	.57
209509CD	161	8	T3 1/4 wedge	14.0	.19	1.0	.29	.21	.19
209517CD	168	8	T3 1/4 wedge	14.0	.35	3.0	.29	.22	.17
209525CD	194	8	T3 1/4 wedge	14.0	.27	2.0	.29	.22	.17
209533CD	222	9	GTL-3 miniature screw	2.25	.25	—	.29	.26	.23
209541CD	259	8	T3 1/4 wedge	6.3	.25	.65	.29	.23	.18
209550CD	313	3	T3 1/4 miniature bayonet	28.0	.17	.35	.29	.25	.19
209568CD	327	10	T1 3/4 midget flange	28.0	.04	.34	.35	.30	.25
209576CD	328	10	T1 3/4 midget flange	6.0	.20	.60	.55	.47	.35
209584CD	330	10	T1 3/4 midget flange	14.0	.08	.50	.39	.34	.29
209592CD	334	11	T1 3/4 midget groove	28.0	.04	.34	.49	.40	.33
209605CD	335	15	T1 3/4 midget screw	28.0	.04	.34	.59	.48	.36
209613CD	344	10	T1 3/4 midget flange	10.0	.014	.002	.99	.89	.79
209621CD	345	10	T1 3/4 midget flange	6.0	.04	.03	.79	.64	.46
209630CD	370	10	T1 3/4 midget flange	18.0	.04	.15	.99	.89	.79
209648CD	376	10	T1 3/4 midget flange	28.0	.06	.34	.69	.59	.49
209656CD	379	11	T1 3/4 midget groove	6.3	.20	.40	.99	.89	.74
209664CD	381	10	T1 3/4 midget flange	6.3	.20	.40	.59	.44	.34
209672CD	382	10	T1 3/4 midget flange	14.0	.08	.30	.49	.40	.34
209681CD	385	10	T1 3/4 midget flange	28.0	.04	.15	.49	.41	.34
209699CD	386	11	T1 3/4 midget groove	14.0	.08	.30	.49	.35	.30
209701CD	387	10	T1 3/4 midget flange	28.0	.04	.30	.39	.27	.26
209710CD	388	11	T1 3/4 midget groove	28.0	.04	.30	.49	.32	.28
209728CD	394	10	T1 3/4 midget flange	12.0	.04	.12	.49	.44	.38
209736CD	656	8	T3 1/4 wedge	28.0	.06	.62	.29	.21	.17
209752CD	657	8	T3 1/4 wedge	28.0	.08	.62	.29	.23	.18
202100CD	683	12	T1 wire terminal	5.0	.06	.05	.49	.35	.26
209761CD	685	13	T1 sub midget flange	5.0	.06	.05	1.29	1.19	.99
209779CD	715	12	T1 wire terminal	5.0	.115	.15	.99	.89	.79
209787CD	755	3	T3 1/4 miniature bayonet	6.3	.15	.33	.59	.47	.35
209795CD	756	3	T3 1/4 miniature bayonet	14.0	.08	.31	.79	.65	.49
209808CD	757	3	T3 1/4 miniature bayonet	28.0	.08	.62	.49	.38	.33
210438CD	1156	7	S-8 sngl contact bayonet	12.8	2.1	32/3	.49	.39	.35
210446CD	1157	14	S-8 double contact index	12.8/14	21/59	32/3	.39	.34	.29
209816CD	1450	4	G3 1/2 miniature bayonet	24.0	.035	.23	.99	.89	.79
209824CD	1813	3	T3 1/4 miniature bayonet	14.4	.10	.86	.35	.34	.23
209832CD	1815	3	T3 1/4 miniature bayonet	14.0	.20	1.4	.49	.41	.30
209841CD	1816	3	T3 1/4 miniature bayonet	13.0	.33	3.0	.35	.26	.21
209859CD	1818	3	T3 1/4 miniature bayonet	24.0	.17	3.3	.99	.89	.79
209867CD	1819	3	T3 1/4 miniature bayonet	28.0	.04	.34	.29	.25	.19
209875CD	1820	3	T3 1/4 miniature bayonet	28.0	.10	1.6	.49	.34	.24
209883CD	1821	15	T3 1/4 screw	28.0	.17	3.4	.99	.89	.79
209891CD	1822	3	T3 1/4 miniature bayonet	36.0	.10	2.1	.49	.33	.29
209904CD	1829	3	T3 1/4 miniature bayonet	28.0	.07	1.0	.29	.24	.19

Incandescent Lamps (Continued)

Part No.	Mfr. Cross Ref. No.	Fig.	Description	Volts (VDC)	Current (A)	MSCP	Pricing		
							1	10	100
209912CD	1835	3	T3 1/4 miniature bayonet	55.0	.05	1.1	\$.49	\$.39	\$.34
209921CD	1847	3	T3 1/4 miniature bayonet	6.3	.15	.38	.59	.49	.44
209939CD	1850	3	T3 1/4 miniature bayonet	5.0	.09	.25	.59	.44	.39
209947CD	1864	3	T3 1/4 miniature bayonet	28.0	.17	3.0	.69	.55	.49
209955CD	1866	3	T3 1/4 miniature bayonet	6.3	.25	.65	.39	.29	.25
209963CD	1891	3	T3 1/4 miniature bayonet	14.0	.24	2.0	.49	.34	.29
209971CD	1893	3	T3 1/4 miniature bayonet	14.0	.33	2.0	.59	.45	.39
141073CD	2182	16	T1 3/4 wire terminal	14.0	.08	.30	.59	.53	.48
141065CD	2200	16	T1 3/4 wire terminal	5.0	.06	.05	.59	.53	.48
141057CD	6833	17	T 3/4 wire terminal	5.0	.06	.05	1.29	1.19	.95
209998CD	7219	12	T1 wire terminal	12.0	.06	.15	.29	.26	.23
210008CD	7328	18	T1 3/4 bi-pin	6.0	.20	.60	.99	.89	.69
210016CD	7335	10	T1 3/4 midget flange	5.0	.115	.15	.79	.69	.59
210024CD	7341	10	T1 3/4 midget flange	28.0	.065	.65	.89	.73	.69
141006CD	7361	18	T1 3/4 bi-pin	5.0	.06	.05	1.29	1.15	.99
210032CD	7382	18	T1 3/4 bi-pin	14.0	.08	.30	.49	.39	.35
210041CD	7387	18	T1 3/4 bi-pin	28.0	.04	.30	.59	.49	.39
210059CD	7632	19	T1 1/4 bi-pin	28.0	.04	.32	1.49	1.29	.99
210067CD	7683	20	T1 bi-pin	5.0	.06	.05	1.39	1.19	1.09
210075CD	7715	20	T1 bi-pin	5.0	.115	.15	1.39	1.29	1.19
210083CD	7839	20	T1 bi-pin	28.0	.024	.15	1.39	1.29	1.09
210227CD	6PSB	21	T2 tel. slide base type 5	6.0	.14	550	.79	.69	.59
210112CD	12ESB	21	T2 tel. slide base type 5	12.0	.04	650	.79	.64	.57
210121CD	12PSB	21	T2 tel. slide base type 5	12.0	.17	2000	.89	.75	.59
210139CD	24ESB	21	T2 tel. slide base type 5	24.0	.04	850	.79	.64	.57
210147CD	24MB	22	T2 miniature bayonet	24.0	.073	3000	1.29	1.09	.89
210155CD	24PSB	21	T2 tel. slide base type 5	24.0	.073	3000	.69	.59	.49
210163CD	28ESB	21	T2 tel. slide base type 5	28.0	.04	1500	.79	.59	.54
210171CD	28MB	22	T2 miniature bayonet	28.0	.04	1600	.99	.89	.79
210180CD	28PSB	21	T2 tel. slide base type 5	28.0	.04	1600	.79	.59	.49
210198CD	48PSB	21	T2 tel. slide base type 5	48.0	.053	1800	.99	.79	.59
210201CD	60MB	22	T2 miniature bayonet	60.0	.05	2200	.99	.89	.79
210219CD	60PSB	21	T2 tel. slide base type 5	60.0	.05	2200	.69	.59	.49
210091CD	120MB	22	T2 miniature bayonet	120	.025	1200	.99	.69	.65
210104CD	120PSB	21	T2 tel. slide base type 5	120	.025	1200	.89	.74	.68
210340CD	PR2	23	B3 1/2 sngl cont. mini flange	2.38	.50	.80	.59	.39	.34
210358CD	PR3	23	B3 1/2 sngl cont. mini flange	3.57	.50	1.5	.59	.49	.44
210366CD	PR4	23	B3 1/2 sngl cont. mini flange	2.33	.27	.40	.55	.45	.39
210374CD	PR6	23	B3 1/2 sngl cont. mini flange	2.47	.30	.45	.59	.44	.34

Neon Lamps



Part No.	Mfr. Cross Ref. No.	Fig.	Description	Voltage (VAC)	Current (mA)	Pricing		
						1	10	100
27351CD	A1A (NE-2)	1	Wire terminal	65-120	0.5	\$.49	\$.39	\$.29
210243CD	A1B	1	Wire terminal	65-120	0.3	.39	.29	.25
210251CD	A1C	1	Wire terminal	65-120	1.2	.39	.29	.25
210260CD	A9A (NE-2E)	1	Wire terminal	65-120	0.7	.29	.25	.19
210278CD	B1A (NE-51)	2	T3 1/4 miniature bayonet	65-120	0.3	.79	.69	.59
210286CD	B2A (NE-51H)	2	T3 1/4 miniature bayonet	65-120	1.2	.69	.49	.39
210294CD	B7A (NE-45)	3	T4 1/2 candelabra screw	65-120	2.0	4.99	4.49	3.49
210307CD	B9A (NE-48)	4	T4 1/2 D.C. bayonet	65-120	2.0	3.99	3.49	2.99
210315CD	C2A (NE-2H)	1	Wire terminal	65-120	1.9	.39	.34	.29

Scott Edwards Electronics, Inc.

Serial LCD Modules

- Includes instruction codes for character generation, cursor control, printing, etc. Examples for Stamps in PBASIC included.
- One-year warranty

Ideal for use w/ BASIC Stamps (pg 200), 80C52-BASIC controllers (pg 71) and PCs!

16 characters x 2 lines Integrated Display

- 1200-9600bps serial input with 16-byte input buffer
- Four inputs for switches/buttons that can be read via the serial connection
- EEPROM storage of settings, six custom characters, and a text screen that can be automatically displayed at startup (splash screen)
- Serial control of the standard LED backlight
- Low current draw: 5mA (backlight off) to 40mA (backlight on and bright)
- Power requirement: 4.8 - 5.5VDC @ 5mA (recommend P/N 164101CD, pg 54)
- Module size: 3.2"L x 2.0"W x 0.5"T



Part No.	Description	1	10	25
150990CD	LCD module	\$48.95	\$44.09	\$39.65

16 characters x 2 lines LCD Serial Backpack®

- High-contrast supertwist display
- Serial "backpack" accepts RS232, or inverted CMOS, TTL at 2400 or 9600bps
- Power requirement: 4.8 - 5.5VDC @ 3mA (recommend P/N 164101CD, pg 54)
- Connector: 5-pin header (recommend P/N 163686CD, pg 127) • Module size: 3.1"L x 1.4"W x 0.7"T



Part No.	Description	1	10	25
133129CD	LCD module	\$59.95	\$53.99	\$48.99

20 Characters x 4 Lines Graphics LCD

- 120 x 32 pixel graphics screen
- 2400 or 9600 bps serial input
- EEPROM stores text font and 6 full-screen images
- Supports multiple fonts and font sizes
- Included utility program lets you create and download pictures and fonts
- Power requirement: 9V battery or 5V power supply (recommend P/N 164101CD, pg 54)
- Module size: 3.1"L x 1.9"W x 0.8"T



Includes: Battery snap connectors, sample programs and manual on disk

Part No.	Description	1	10
158166CD	20 x 4 serial LCD display	\$119.95	\$107.99

40 characters x 4 lines LCD Serial Backpack®

- High-contrast supertwist display with unique "big character": backlet mode - prints "1" numbers and letters automatically
- Serial input at 1200, 2400, 4800 or 9600bps
- Power requirement: 5VDC @ <10mA (recommend P/N 164101CD, pg 54)
- Module size: 7.5"L x 2.2"W x 0.9"T



Part No.	Description	1	10
136485CD	40 x 4 serial LCD display ..	\$199.95	\$179.99

16 Characters x 2 Lines Serial LCD Module

- Backlight control, bar graphs, large digits, multiple displays, software contrast control, auto line wrapping, and auto scroll feature
- Serial input at 1200-19,200bps (jumper selectable)
- Connect 16 modules using same 2 wire interface
- Backlight supply current: 40mA typical
- Power requirement: 5VDC @ 9mA (recommend P/N 164101CD, pg 54)
- Display size: 2.5"L x 0.7"W • Weight: 0.6 lbs.
- Module size: 3.2"L x 1.5"W x 0.8"T

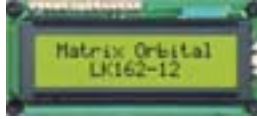

SALE

Includes: Manual and software

Part No.	Description	1	10	25
174166CD	16 x 2 w/ interface	\$52.39	\$51.19	\$49.95

20 x 4 Serial LCD Modules

- 20 characters x 4 line display with large digit mode
- Backlight control, bar graphs, large digits, multiple displays, software contrast control, auto line wrapping and auto scroll feature
- Backlight supply current: 90mA typical
- Serial input at 1200-19,200bps (jumper selectable)
- Connect 16 modules using the same 2 wire interface
- Display size: 3.0"L x 1.0"W • One-year warranty



150957CD



157323CD

SALE

Includes: Manual and software

Part No.	Description	1	10	25
150957CD	20 x 4 Serial LCD Module	\$54.19	\$52.69	\$51.19
157323CD	20x4 Serial LCD Module with keypad Interface	\$72.95	71.15	68.99

20 Characters x 4 Lines Serial VFD Display

- Bar graphs, large digits, multiple displays, software contrast control, auto line wrapping and scroll feature
- Power off supply current: 9mA
- Serial input of 1200-19,200bps (jumper selectable)
- Display size: 2.8"L x .82"W
- Module size: 3.9"L x 2.4"W x 1.0"T
- Requires: 5VDC @ 275mA typical (recommended P/N 164101CD, pg 54)



SALE

Includes: Manual and software

Part No.	Product No.	1	10	25
174158CD	VFD2041	\$106.99	\$104.25	\$101.19

Jameco's Low-Price Guarantee

We'll match the advertised price of any like product.

Graphics LCD Serial Display

40 characters x 8 lines Maximum

- 40 characters x 8 lines max. display with 5 x 7 font
- Backlight control, bar graphs, large digits, multiple displays, software contrast control, auto line wrapping, and auto scroll feature
- Pixel layout: 240 x 64 pixels
- Serial input: 1200-19,200bps (jumper configurable)
- Backlight supply current: 160mA typical
- Power requirement: 5VDC @ 31mA typical (recommend P/N 164101CD, pg 54)
- Display size: 5.2"L x 1.5"W • Weight: 0.9 lbs.
- Module size: 7.1"L x 2.6"W x 0.7"T

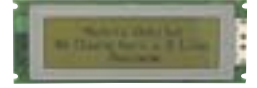

Includes: Manual and software

Part No.	Description	1	10	25
174182CD	Graphic display ...	\$165.99	\$161.69	\$157.49

SALE

Serial LCD Interface Module

For Parallel LCD Displays with Hitachi 44780 Chipset

- Supports 1 x 8 thru 4 x 20 LCD display formats
- Provides word wrap, control character processing for display blanking, cursor blanking, up-down-left-right cursor controls
- Compatible with P/Ns 151933CD, 171715CD and 198803CD (pg 99) • Size: 1.5"L x 1.0"W



Part No.	Description	1	10	25
157981CD	LCD serial module ..	\$22.95	\$20.95	\$18.95

VL 0.5" High 4-Digit Field Effect LCD Display

- Compatible with socket P/N 78641CD (2), pg 129
- Pin spacing: 0.1" centers
- 40-pin package (no connector required)
- Size: 2.0"L x 1.2"H x 0.1"D
- Digital multimeters, thermometers, pressure gauges, timers, clocks (12 or 24 hour format) and frequency counters



Part No.	Description	1	10	25
17110CD	4-digit LCD w/ pins	\$14.95	\$13.49	\$12.15

0.6" High 3½-Digit & 4½-Digit LCD Digital Panel Meters



- Input Ranges: 200mV, 20V, 200V, 500V
- Supply voltage: 8-12VDC (recommend 9V battery P/N 151095CD, pg 202)
- Automatic polarity indication
- Input impedance: >100MΩ • Accuracy: ±0.5%
- Size: 2.7"L x 1.7"W

Part No.	Prod. No.	Digits	1	10	25
108388CD	PM-428	3 ½	\$12.95	\$11.95	\$10.95
175951CD	PM-128	3 ½	12.95	11.95	10.95
146835CD	PM-188BL	3 ½	19.95	17.99	16.19
123140CD	PM-32B	4 ½	27.95	24.95	22.49

16 Characters x 1 Line Parallel LCD Module

- Super twisted nematic gray, transfective type
- Easily interfaced to a microprocessor with common 4-bit and 8-bit parallel inputs/outputs
- Connected at general purpose CMOS signal level
- Built-in character generator ROM (225 characters @ 5 x 7 dot matrix pattern; RAM (8 different user programmed); and display data RAM (80 x 8-bits)
- Display clear, cursor home, display & cursor ON/OFF, blink character, cursor shift, and display shift feature



Requirements: 4.5VDC – 5.5VDC @ 600mA wall transformer (recommend P/N 171301CD, pg 54)

Part No.	Module Size	1	10	25
198803CD	3.1"L x 1.4"W x 0.3"T	\$13.95	\$12.59	\$9.19



16 x 4 LCD Parallel Display

- 16 characters x 4 lines
- 5 x 8 dot matrix
- 4 or 8 bit parallel interface
- Clear/reflective type LCD display
- Control LSI HD4470 or equivalent & column driver MSM5259 or equivalent
- Display size: 2.4"L x 1.0"H
- Module size: 3.4"L x 2.4"W x 0.3"T



Power requirements: 5VDC @ 2mA max. (recommend P/N 164101CD, pg 54)

Part No.	Description	1	10	25
210761CD	16 x 4 LCD display	\$22.95	\$19.95	\$18.69

20 x 1 Parallel Display



- Built-in controller: HD44780
- Character font size: 0.45"W x 0.26"H
- Maximum input voltage: 5.5VDC
- Operating input voltage: 5VDC
- Display size: 6.5"L x 1.3"W
- Module size: 7.2"L x 1.6"W x 0.4"T

SALE

Part No.	Description	1	10	25
206615CD	LCD Module	\$39.95	\$34.95	\$29.95



20 Characters x 4 Lines Parallel LCD Module

- 5 x 8 dot matrix
- Yellow mode transmissive type LCD
- Yellow-green LED backlight
- 4 or 8-bit parallel interface
- LSI control HD44780 or equivalent & column driver MSM5259 or equivalent
- Display size: 3.0"W x 1.0"H
- Module size: 3.9"L x 2.4"W x 0.5"T



Power requirements: 5VDC @ 3.5mA (recommend P/N 164101CD, pg 54)

Part No.	Description	1	10	25
216012CD	20 x 4 LCD display	\$29.99	\$26.99	

40 x 2 Parallel LCD Module with Backlight



- 40 x 2 lines character display
- Control chip HCD44780
- Character font: 5 x 8 dots
- Column driver: KS0063B
- Backlight: yellow-green
- Supply voltage (logic): 5VDC @ 5mA
- Display size: 5.81"L x 0.45"W
- Module size: 7.2"L x 1.4"W x 0.4" Thick

Part No.	Description	1	10	25
215159CD	40 x 2 parallel LCD	\$29.99	\$26.99	\$24.29



LCD MSG II Discrete LCD Message Module

A simple LCD discrete module that provides the user the ability to display custom messages on a standard LCD module, quickly and easily. The module contains its own embedded processor and non-volatile storage for up to 16 user-definable messages each containing up to 160 characters, plus a 25-character memo message for product I.D. or serialization.



- Switch, up/down, automatic, ticker tape
- Individual message blink attribute
- LCD standalone self-test display
- Negative 5V generation for extended temperature range LCD modules
- Provides serial programmability
- Selectable communication ports/display formats
- Windows® message editor: full copy, cut and paste operations
- Compatible with P/Ns 151933CD, 171715CD and 198803CD (see left)

Part No.	Description	1	10	25
199646CD	MSG II	\$44.95	\$40.49	\$36.45

LCD Parallel Displays

- 8-bit interface data bus
- Controller: KS0066U or equivalent
- Character font size: 0.125"W x 0.200"H
- Maximum input voltage: 5.3VDC
- Operating input voltage: 5VDC (recommend P/N 164101CD, pg 54)



171715CD

171715CD: 16 Characters x 2 Lines

- Display size: 2.5"L x 0.7"W
- Module size: 3.4"L x 1.2"W x 0.5"T

171723CD: 20 Characters x 2 Lines

- Display size: 3.3"L x 0.7"W
- Module size: 4.6"L x 1.5"W x 0.4"T

Part No.	Prod. No.	Description	1	10	25
171715CD	AC162A	14-pin/term	\$19.95	\$17.95	\$15.95
171723CD	AC2 02A	16-pin/term	24.95	22.49	20.25

16 x 4 Parallel LCD Module

- 16 x 4 character display (.78"H)
- Character font: 5 x 8 dots
- Input data: 4-bit or 8-bit interface available
- Display size: 2.4"L x 1.0"W x 0.06"T
- Module size: 3.4"L x 2.4"W x 0.25"T



Point Six

Requires: 4.5V @ 2mA wall transformer (recommend P/N 164101CD, pg 54)

Part No.	Description	1	10	25
151933CD	16 x 4 parallel LCD ...	\$24.95	\$22.49	\$19.95

Even lower OEM pricing for larger orders!

Corporate Customers

Call 1-800-831-4242 for details today.

CDS Photocells

- Applications include: auto-focus lenses, exposure meters, contrast controls for TVs, dimmer or light switches, flame detectors, electronic toys, street lamp switches, optocouplers
- Generate variable signal based on detection of light levels
- Operating temperature: -30°C to +70°C
- Cadmium Sulfide (CDS)
- Soldering: 230°C for 3 seconds

Part No.	Mfr. Cross Ref. No.	Rating		Resistance (Ω)		Size (inches)		Lead Spacing (inches)	Lead Length (inches)	Pricing			
		Vp	mW	Dark	Light	A	B			1	10	100	1000
136063CD	CDS18	20	40	100k	10k	0.14	0.17	0.10	1.50	\$.69	\$.62	\$.55	\$.49
136047CD	CDS05	50	250	100k	10k	0.25	0.29	0.18	1.50	.69	.62	.55	.49
136055CD	CDS08	50	200	100k	10k	0.40	0.44	0.30	1.50	.89	.79	.69	.60
202366CD	CDS0029001	150	90	300k	27k	0.14	0.17	0.10	1.02	1.49	1.35	1.19	1.09
202374CD	CDS0029006	150	90	5M	80k	0.14	0.17	0.10	1.02	1.49	1.35	1.19	1.09
202391CD	CDS0029203	150	90	20M	5k	0.14	0.17	0.10	1.02	1.49	1.35	1.19	1.09
202382CD	CDS0029008	150	90	20M	10k	0.14	0.17	0.10	1.02	1.49	1.29	1.15	.99
202420CD	CDS0018003	150	100	500k	16k	0.17	0.20	0.13	1.02	1.49	1.29	1.15	.99
202403CD	CDS0018001	150	100	200k	3k	0.17	0.20	0.13	1.02	1.49	1.35	1.19	1.09
202411CD	CDS0018006	150	100	5M	80k	0.17	0.20	0.13	1.02	1.49	1.35	1.19	1.09
120310CD	CDS002	150	90	2M	27k	0.14	0.17	0.10	1.44	1.45	1.20	1.09	.99
202438CD	CDS0037004	200	150	500k	15k	0.25	0.29	0.20	1.44	1.49	1.29	1.15	.99
120301CD	CDS0037001	200	150	300k	3.6k	0.25	0.29	0.20	1.44	1.79	1.59	1.45	1.29
202446CD	CDS0037005	200	150	20M	50k	0.25	0.29	0.20	1.44	1.79	1.59	1.45	1.29
120299CD	CDS0045001	350	400	300k	8k	0.38	0.43	0.30	1.44	1.79	1.59	1.45	1.29
202454CD	CDS0045003	350	400	1M	12k	0.37	0.43	0.30	1.44	1.49	1.29	1.15	.99

Miniature Toggle Switches

- Mounting hole diameter: 1/4"
- Includes: Mounting hardware

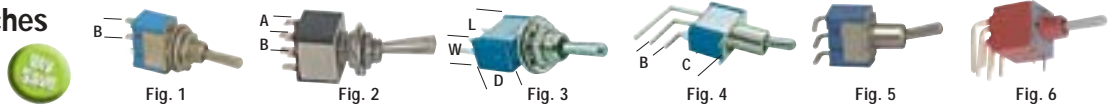

Part No.	Mfr. Cross Ref. No.	Fig.	Pins	Type () Momentary	Dimensions L" x W" x D"	Lead Spacing			Contact Rating (A @ VAC)	Lead Type	Lever Type	Pricing				
						A"	B"	C"				1	10	100	250	1000
76523CD	JMT113	1	2	SPST on-off	.52 x .32 x .38	—	.185	—	6 @ 125 & 3 @ 250	Solder lugs	Round	\$1.15	\$1.03	\$.93	\$.75	\$.65
21936CD	JMT123	3	3	SPDT on-on	.52 x .32 x .38	—	.185	—	5 @ 125 & 2 @ 250	Solder lugs	Round	1.15	1.03	.93	.75	.65
21910CD	JMT121	3	3	SPDT on-off-on	.52 x .32 x .38	—	.185	—	5 @ 125 & 2 @ 250	Solder lugs	Round	1.35	1.25	1.09	.95	.85
22832CD	LFH123	3	3	SPDT on-on	.52 x .28 x .36	—	.185	—	5 @ 125 & 2 @ 250	Solder lugs	Flat	1.15	1.05	.95	.85	.75
75854CD	SWM132	3	3	SPDT on-on	.52 x .32 x .38	—	.185	—	6 @ 125 & 3 @ 250	Solder lugs	Round	1.19	1.09	.99	.79	.55
75889CD	SWM129	3	3	SPDT (on)-off-(on)	.52 x .32 x .38	—	.185	—	6 @ 125 & 3 @ 250	Solder lugs	Round	1.69	1.55	1.32	.91	.79
26331CD	MPC123	3	3	SPDT on-on	.52 x .32 x .37	—	.185	—	6 @ 125 & 3 @ 250	PC	Round	1.39	1.25	1.12	.95	.78
26315CD	MPC121	3	3	SPDT on-off-on	.52 x .32 x .37	—	.185	—	5 @ 125 & 2 @ 250	PC	Round	1.29	1.15	.89	.70	.49
71597CD	SWM148	4	3	SPDT on-on	.52 x .32 x .38	—	.185	.20	5 @ 125 & 2 @ 250	PC right angle	Round	1.19	1.09	.85	.65	.45
75871CD	SWM145	5	3	SPDT on-on	.52 x .32 x .38	—	.185	.20	6 @ 125 & 3 @ 250	PC right angle	Round	1.49	1.35	1.09	.86	.79
22841CD	LFH221	2	6	DPDT on-off-on	.52 x .52 x .38	.20	.185	—	3 @ 125 & 1 @ 250	Solder lugs	Flat	1.45	1.35	1.19	1.09	.95
21979CD	JMT223	2	6	DPDT on-on	.52 x .52 x .38	.20	.185	—	5 @ 125 & 2 @ 250	Solder lugs	Round	1.49	1.29	1.15	.99	.59
22859CD	LFH223	2	6	DPDT on-on	.52 x .52 x .38	.20	.185	—	5 @ 125 & 2 @ 250	Solder lugs	Flat	1.29	1.19	1.05	.95	.85
105814CD	SWA208	2	6	DPDT on-(on)	.52 x .52 x .38	.20	.185	—	5 @ 125 & 2 @ 250	Solder lugs	Round	1.75	1.57	1.25	.95	.69
75900CD	SWM133	2	6	DPDT on-on	.52 x .52 x .38	.20	.185	—	6 @ 125 & 3 @ 250	Solder lugs	Round	1.49	1.35	1.25	.99	.85
21952CD	JMT221	2	6	DPDT on-off-on	.52 x .52 x .38	.20	.185	—	6 @ 125 & 3 @ 250	Solder lugs	Round	1.29	1.16	1.04	.89	.75
75951CD	SWM130	2	6	DPDT (on)-off-(on)	.52 x .52 x .38	.20	.185	—	6 @ 125 & 3 @ 250	Solder lugs	Round	1.49	1.35	1.25	.99	.89
26366CD	MPC223	2	6	DPDT on-on	.52 x .52 x .38	.20	.185	—	5 @ 125 & 2 @ 250	PC	Round	1.49	1.35	1.15	.85	.59
26358CD	MPC221	2	6	DPDT on-off-on	.52 x .52 x .38	.20	.185	—	5 @ 125 & 2 @ 250	PC	Round	1.19	1.09	.86	.64	.45
202964CD	WI24	6	6	DPDT on-off-(on)	.50 x .50 x .46	.15	.15	.20	6 @ 125 & 3 @ 250	PC right angle	Round	.99	.89	.79	.69	.59

Subminiature Toggle Switches

- Mounting hole diameter: 7/32"
- Pre-tinned leads
- Metal construction
- Includes: Mounting hardware

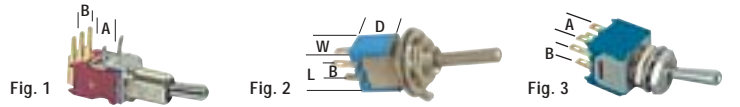

Part No.	Mfr. Cross Ref. No.	Fig.	Pins	Type	Dimensions L" x W" x D"	Lead Spacing			Contact Rating (A @ VDC)	Lead Type	Lever Type	Pricing				
						A"	B"	C"				1	10	100	250	1000
106067CD	SWP124	1	3	SPDT on-on	.25 x .33 x .40	.20	.10	—	30mA @ 5VDC	PC right angle	Round	\$1.99	\$1.83	\$1.59	\$1.44	\$1.32
72160CD	SW1501	2	2	SPST on-off	.33 x .21 x .33	.10	—	—	1.5A @ 250VAC	Solder lugs	Round	1.29	1.24	1.14	.98	.79
75969CD	SWM136	2	3	SPDT on-on	.33 x .21 x .33	.10	—	—	3A @ 125VAC	Solder lugs	Round	1.55	1.44	1.21	.86	.63
72557CD	SW1502	2	3	SPDT on-off-on	.33 x .21 x .33	.10	—	—	1.5A @ 250VAC	Solder lugs	Round	1.35	1.25	.99	.75	.55
138907CD	SW1503	3	6	DPDT on-off-on	.36 x .37 x .33	.17	.10	—	3A @ 120VAC	Solder lugs	Round	1.29	1.05	.85	.65	.55
75977CD	SWM137	3	6	DPDT on-on	.33 x .37 x .33	.17	.10	—	1.5A @ 250VAC	Solder lugs	Round	1.29	1.05	.85	.65	.55

Full Size Toggle Switches

- Panel mount
- Mounting hole diameter: 1/2"
- Full-size round lever
- Medium duty
- Keyed plate indicates switch position
- Includes: Mounting hardware and on/off plate

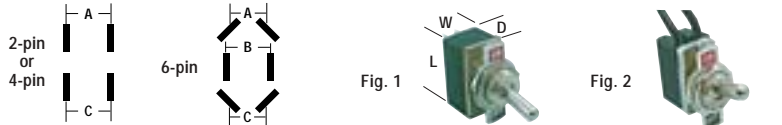

Part No.	Mfr. Cross Ref. No.	Fig.	Pins	Type	Dimensions L" x W" x D"	Lead Spacing			Contact Rating (A @ VAC)	Lead Type	Lever Type	Pricing				
						A"	B"	C"				1	10	100	250	1000
76241CD	SWM128	1	2	SPST on-off	1.00 x .56 x .52	.23	—	—	4 @ 125 & 2 @ 250	Solder lugs	Round	\$1.45	\$1.29	\$1.15	\$.99	\$.89
158060CD	JKN32	1	4	DPST on-off	1.00 x .56 x .52	.23	—	.23	4 @ 125 & 2 @ 250	Solder lugs	Round	1.15	1.05	.95	.85	.75
76259CD	SWM126	1	6	DPDT on-on	1.12 x .77 x .60	.30	.60	.40	5 @ 125 & 3 @ 250	Solder lugs	Round	1.75	1.59	1.29	.99	.85
158078CD	JKN3CC	1	6	DPDT on-on	1.19 x .76 x .73	.44	.59	.44	10 @ 125 & 6 @ 250	Screw lugs	Round	1.75	1.59	1.29	.99	.85
76232CD	SWM125	2	2	SPST on-off	1.00 x .53 x .51	—	—	—	6 @ 125 & 3 @ 250	6" lead wire	Round	1.75	1.59	1.45	1.29	1.15

Slide Switches

- Two mounting flanges
- Top actuation except P/N 204142CD
- Nylon actuator
- Phenolic insulated

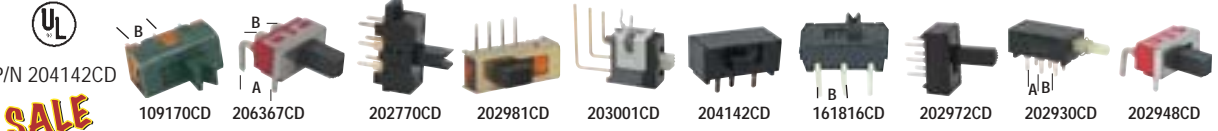

Part No.	Pins	Type	Description	Housing Material #	Dimensions			Lead Spacing		Contact Rating	Lead Length	Actuator Height	Pricing			
					L"	W"	D"	A"	B"				1	10	100	250
109170CD	3	SPDT on-on	PC mount	Plastic	.22	.45	.23	—	.12	0.5A @ 50VDC	.17"	.15"	\$.35	\$.29	\$.22	\$.17
206367CD	3	SPDT on-off	PC mount right angle	Metal	.26	.52	.27	.37	.20	0.5A @ 125VAC	.27"	.31"	.34	.30	.26	.22
202770CD	6	SPDT on-on	PC mount	Plastic	.71	.36	.38	.19	.20	0.1A @ 30VDC	.17"	.32"	.33	.28	.25	.19
202981CD	4	SP3T on-on-on	PC mount right angle	Metal	.61	.24	.18	—	.10	0.3A @ 125VAC	.26"	.15"	.29	.23	.17	.12
203001CD	3	SPDT on-off-on	PC mount right angle	Metal	.36	.20	.39	—	.11	0.1A @ 28VDC	.18"	.10"	.29	.23	.17	.12
204142CD	3	SPDT on-on*	PC mount	Plastic	.77	.40	.37	—	.19	2.0A @ 28VDC	.19"	.17"	.35	.29	.22	.15
161816CD	6	DPDT on-on†	PC mount	Plastic	.38	.14	.13	.13	.11	0.1A @ 20VDC	.11"	.08"	.49	.45	.34	.24
202972CD	6	DPDT on-on	PC mount	Plastic	.77	.43	.29	.24	.18	1.0A @ 24VDC	.21"	.51"	.29	.26	.23	.19
202930CD	6	DPDT on-on	PC mount	Plastic	.76	.44	.29	.22	.18	4A @ 28VDC	.23"	.40"	.18	.16	.14	.13
202948CD	3	SPDT on-on	PC mount right angle	Metal	.50	.27	.26	.38	.19	6A @ 28VDC	.13"	.19"	.29	.26	.23	.19

*Side actuated † Plastic – flanges # Plastic: 6/6 nylon; metal: steel zinc plated

Pushbutton Switches

• Contact rating: 3A @ 125VAC (except P/N 106112CD: 3A @ 110VAC) • 2-pin • Lead type: solder terminal

SALE

Mountain
Switch

Miniature Soft Touch Switches

Part No.	Product No.	Fig.	Type () Momentary	Dimensions	Lead Spacing	Thread Diameter	Button Color	Pricing			
								1	10	100	1000
164494CD	DS450R	1	SPST off-on	1.2"L x .59"Dia.	.175"	.387"	Red	\$1.79	\$1.75	\$1.72	\$1.69
164486CD	DS463R	1	SPST off-(on)	1.2"L x .59"Dia.	.175"	.387"	Red	1.64	1.58	1.47	1.45
164523CD	DS466R	2	SPST off-(on)	1.2"L x .60"Sq.	.160"	.383"	Red	1.69	1.63	1.59	1.55
196921CD	196921I	2	SPST off-on	1.6"L x 1.6"Sq.	.189"	.450"	Red	1.99	1.79	1.44	1.09
164558CD	DS471R	3	SPST off-(on)	1.2"L x .75"Sq.	.160"	.387"	Red	1.59	1.49	1.45	1.39

† Click type

Standard Touch Switches

Part No.	Product No.	Fig.	Type () Momentary	Dimensions	Lead Spacing	Thread Diameter	Button Color	Pricing			
								1	10	100	1000
164566CD	MS402R	4	SPST off-(on)	.73"L x .22"Dia.	.078"	.190"	Red	\$.99	\$.96	\$.94	\$.93
164582CD	DS016B	5	SPST off-(on)	.88"L x .46"Dia.	.220"	.354"	Black	1.49	1.39	1.25	1.15
164638CD	MS3120R	6	SPST off-(on)	1.1"L x .31"Dia.	.175"	.268"	Red	.89	.79	.69	.55
164671CD	NS801MOB	7	SPST off-(on)	1.1"L x .59"Dia.	.213"	.468"	Black	2.15	1.89	1.69	1.55
106112CD	DS412R*	8	SPST off-(on)	.63"L x .66"Dia.	.275"	.750"	Red	1.19	.99	.89	.85

* Solder lugs



Figure 1



Figure 2



Figure 3



Figure 4



Figure 5



Figure 6



Figure 7



Figure 8

Pushbutton Switches

IP Series Pushbutton Switches

- Panel mount
- Insulation resistance: 1GΩ min. @ 500VDC
- Dielectric strength: 1500Vrms min.



- Initial contact resistance: 50mΩ max.
- Mounting hole: 1/2"Dia.
- Mechanical life: 1,000,000 cycles min.

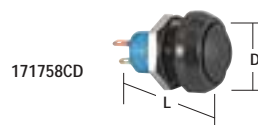

171758CD



171766CD

Part No.	Product No.	Pins	Type () Momentary	Dimensions			Lead Spacing	Contact Rating	Terminal Type	Pricing			
				L	W	D				1	10	100	250
171758CD	IPR3SAD2	2	SPST off-(on)	0.82"	—	0.46"	0.19"	0.2A @ 250VAC	Solder	\$10.39	\$9.35	\$8.45	\$7.49
171766CD	IPC3SAD6	2	SPST off-(on)	0.82"	0.69"	0.46"	0.19"	0.2A @ 250VAC	Solder	8.99	7.99	7.29	6.59

AV Series Pushbutton Switches

- Panel mount
- Mounting hole: 3/4"Dia. for P/N 171774CD; 0.85"Dia. for P/N 191062CD
- Insulation resistance: 1000MΩ min
- 171774CD: Initial contact resistance: 10mΩ max. • Dielectric strength: 1000Vrms min.
- 191062CD: w/ mushroom head actuator • Initial contact resistance: 100mΩ max. • Dielectric strength: 2000Vrms min.

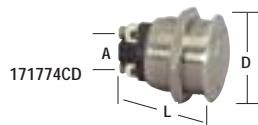

171774CD

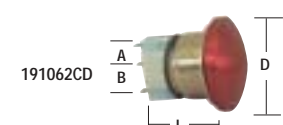

191062CD

Part No.	Product No.	Pins	Type () Momentary	Dimensions		Lead Spacing		Contact Rating	Terminal Type	Pricing			
				L	D	A	B			1	10	100	250
171774CD	AV191003C900	2	SPST off-(on)	1.20"	0.87"	0.37"	—	2A @ 48VDC	Screw	\$10.95	\$9.85	\$8.86	\$7.98
191062CD	AV22PNA62	3	SPDT off-(on)	1.41"	1.18"	0.24"	0.35"	5A @ 250VAC	Solder	29.95	26.95	24.25	21.85

Pushbutton Switches

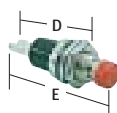

Figure 1

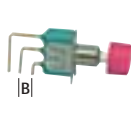

Figure 2

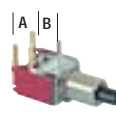

Figure 3



Figure 4

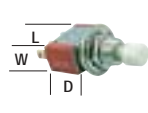

Figure 5

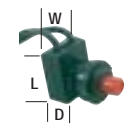

Figure 6

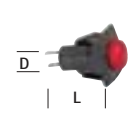

Figure 7

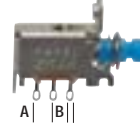

Figure 8

Part Number	Mfr. Cross Ref. No.	Fig.	Pins	Mounting Hole Dia.	Type () Momentary	Dimensions (L" x W" x D")		Lead Spacing		Contact Rating	Terminal Type	Button Color	Pricing				
						L	D	A"	B"				1	10	100	250	1000
26622CD	MS102	1	2	1/4"	SPST off-(on)	.65 (D) x 1.10 (E)	—	.14	3A @ 125VAC	Solder lugs	Red	\$.55	\$.50	\$.45	\$.35	\$.29	
26649CD	MS103	1	2	1/4"	SPST on-(off)	.65 (D) x 1.10 (E)	—	.17	3A @ 125VAC	Solder lugs	Black	.55	.50	.45	.35	.29	
154878CD	PS11-123	2	3	1/4"	SPDT on-(on)	.50 x .27 x .37	—	.14	5A @ 125VAC	Solder, right angle	Red	.85	.75	.69	.59	.45	
71642CD	SWB210	3	2	7/32"	SPST off-(on)	.36 x .20 x .33	.20	.20	1A @ 120VAC	PC right angle	Black	2.19	1.99	1.78	1.60	1.39	
200774CD	TP12SH8AOE	3	3	7/32"	SPDT off-(on)	.32 x .20 x .33	.20	.10	1A @ 120VAC	PC right angle	Black	4.79	3.85	2.86	2.49	2.09	
202999CD	BB16	4	3	1/4"	SPDT on-on	.39 x .35 x .35	.18	.10	0.1A @ 28VAC	Solder, right angle	White	1.69	1.56	1.43	1.25	.89	
121304CD	CK8121	5	3	1/4"	SPDT on-(on)	.52 x .27 x .38	—	.185	5A @ 125VAC	Solder lugs	White	3.59	3.25	2.95	2.65	2.39	
28062CD	PB126	5	3	1/4"	SPDT on-(on)	.52 x .28 x .38	—	.185	5A @ 120VAC	Solder lugs	Red	3.69	3.35	2.85	2.29	1.69	
22200CD	J1881	6	2*	3/8"	SPST on-off, Alt†	.65 x .52 x .40	.25	—	2A @ 14VDC	5" Pigtail	White	1.19	1.09	.94	.83	.72	
22218CD	J1882	6	2*	3/8"	SPST off-(on)	.65 x .52 x .40	.25	—	2A @ 14VDC	5" Pigtail	Red	1.09	.98	.83	.67	.50	
174414CD	R13-510A	7	2	1/2"	SPST off-(on)	.67 (L) x .31 (D)	—	.167	3A @ 125VAC	Solder lugs	Red	.89	.80	.72	.65	.58	
206324CD	SPPJ31319A	8	3	1/4"	SPDT on-off	.58 x .21 x .33	.18	.11	2A @ 30VDC	Solder lugs	Blue	.59	.50	.40	.30	.30	

† Alt = alternate action

* Lead wires



Miniature Basic Lever Switches

- 3 terminals: common; normally open; normally closed
- Size: 1.10"L x 0.40"W x 0.63"H

OMRON Honeywell



187805CD/213479CD



191388CD



159581CD/187792CD
203545CD



159572CD

Part No.	Product No.	Manufacturer	Actuator Type	Contact Form	Contact Rating	Resistance (initial)	Service Life (Mech./Elec.)	Terminal Type	Pricing		
									1	25	50
159572CD	VS10N051C	Highly Electric	Hinged roller (0.60"L)	SPDT-NC	10A@125VAC, 10A@250VAC	15milliΩ (max.)	10M/100k	.183" quick connect	\$2.89	\$2.54	\$2.28
159581CD	VS10N021C2	Highly Electric	Hinge lever (1.05"L)	SPDT-NC	10A@125VAC, 10A@250VAC	15milliΩ (max.)	10M/100k	.183" quick connect	2.45	2.25	1.99
191388CD	V3-715	Honeywell	Pin plunger	SPDT-NC	0.5A@125VAC, 10A@250VAC	—	10M/1M	.220" solder	1.65	1.24	1.05
203545CD	V7-3E11D8-022	Honeywell	Hinge lever (1.07"L)	SPDT-NC	0.5A@125VAC, 10A@250VAC	—	10M/100k	.183" quick connect	2.79	2.59	2.29
187792CD	V-10G2-1C24K	Omron	Hinge lever (1.08"L)	SPDT-NC	0.1A@125VAC, 10A@250VAC	30milliΩ (max.)	50M/300k	.183" quick connect	2.59	2.35	2.19
187805CD	V-10G3-1C24K	Omron	Long hinge lever (2.01"L)	SPDT-NC	0.1A@125VAC, 10A@250VAC	30milliΩ (max.)	50M/300k	.183" quick connect	2.86	2.61	2.41
213479CD	DMC Series	Defond	Long hinge lever (3.56"L)	SPDT-NC	15.1A@125VAC, 15.1A@250VAC	—	—	.250" quick connect	1.85	1.65	1.45



SS Subminiature Basic Switches

- Economical, subminiature basic switch offers long service life
- Free from overtravel restrictions, permits easy setting
- Lead spacing: A = 0.35"; B = 0.29"
- Dimensions: 0.78"L x 0.25"W x 0.40"H



187709CD



187733CD



159599CD



187645CD

Part No.	Product No.	Manufacturer	Actuator Type	Contact Form	Contact Rating	Contact Force	Service Life (Mech./Elec.)	Terminal Type	Pricing		
									1	25	50
187709CD	SS-5GL	Omron	Hinge lever (0.6"L)	SPDT-NC	5A @ 125VAC, 3A @ 250VAC	50g	30M/200k	Solder	\$1.59	\$1.45	\$1.29
187733CD	SS-5GL2	Omron	Hinged roller (0.6"L)	SPDT-NC	5A @ 125VAC, 3A @ 250VAC	50g	30M/200k	Solder	1.35	1.23	1.09
159599CD	SS0505A	Highly Electric	Hinge roller (0.7"L)	SPDT-NC	5A @ 125VAC, 3A @ 250VAC	45g	30M/200k	Solder	3.25	2.92	2.59
187645CD	SS-10D	Omron	Pin plunger	SPDT-NC	10.1A @ 125VAC, 10.1A @ 250VAC	150g	30M/200k	PCB, straight vertical	1.99	1.79	1.65

OMRON D2F Series Subminiature Snap-Action Switch

Ideal for a wide variety of applications from household appliances and office equipment to audio and communications equipment.

- Dimensions: 0.50"L x 0.23"W x 0.26"H • Lead spacing: 0.2"

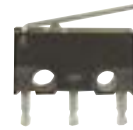

Part No.	Product No.	Manufacturer	Actuator Type	Contact Form	Contact Rating	Contact Resistance (initial)	Service Life (Mech./Elec.)	Terminal Type	Pricing		
									1	25	50
188867CD	D2F-L	Omron	Hinge lever (0.50"L)	SPDT-NC	2A @ 30VDC, 3A @ 125VAC	30milliΩ (max.)	1M/30k	PCB	\$1.05	\$0.95	\$0.85

SPST Round Keylock Switches

- Used in computer & other security systems
- Key removable from 2 positions • Two keys
- Mounting hole = 0.75" except P/N 106649CD = 0.5"
- 196648CD: all keys are alike Includes: Mounting nut



106649CD

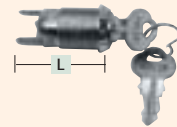

105831CD/196648CD

Part No.	Mfr. Cross Ref. No.	No. Flat, Dia.	Length	Terminal	Voltage/Current	Pricing			
						1	10	50	100
106649CD	KS4B	2, .21"	.55"	Barrel	125VAC/3A	\$3.55	\$3.25	\$2.89	\$2.49
105831CD	KS3B	2, .66"	1.48"	.25" quick connect	125VAC/6A	3.99	3.59	3.29	2.99
196648CD	3313E-M	2, .66"	1.48"	.25" quick connect	125VAC/6A	4.49	3.99	3.65	3.29

PCB Plunger Switch

Use in Place of Shorting Block

- SPST (on/off)
- Contact rating: 50mA @ 24VDC
- Non-removable plunger
- Size: 0.2"W x 0.1"D x 0.38"H
- Lead length: 0.1"L
- 10 piece minimum



Part No.	Description	10	100	1000
172700CD	Plunger switch	\$1.10	\$0.99	\$0.88

Magnetic Reed Switches

- NO (normally open) • Contact form: SPST

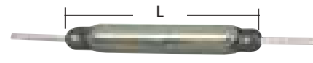

164081CD

Part No.	Mfr. Cross Ref. No.	Contact Rating	Size (L" x Dia.")	Pricing			
				1	10	100	1000
171871CD	MKA141011015	500mA @ 100VDC	0.53 x 0.1	\$0.89	\$0.65	\$0.49	\$0.45
164081CD	MRS1	1A @ 250VAC; 1A @ 50VDC	1.43 x 0.2	.87	.61	.42	.38



We'll match the advertised price of any like product.

Jameco's Low Price Guarantee

It's that simple!

Jameco carries a wide variety of Relays!



See pages 106-108 for our complete selection.



Pushbutton Binary Coded Decimal (BCD) Switch

26788CD (2 switches shown)

Thumbwheel Binary Coded Decimal (BCD) Switch

(2 switches shown) 26817CD

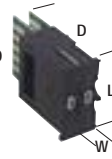

Pushbutton and Thumbwheel Switch Specifications:

- Contact resistance: 100mΩ max.
- 1/16" maximum panel thickness
- Gold plated BE-CU alloy contacts
- 0.15A @ 50VAC/28VDC
- Break before make
- Operating temperature: -40°C to +85°C
- Continuous load: 1 amp max.
- Front snap-tab mounting with end plates
- Switches snap together

Part No.	Mfr. Cross Ref. No.	Description	Size (L" x W" x D")	Character Height	Pricing			
					1	10	50	100
26788CD	MX72	10-position pushbutton	1.2 x 0.3 x 1.7	0.19"	\$5.69	\$5.15	\$4.65	\$4.15
26761CD	MXEP2	Mounting end plates for 26788	1.2 x 0.2 x 1.1	—	1.15	.99	.89	.79
26817CD	MX83	10-position thumbwheel	1.2 x 0.3 x 1.9	0.25"	4.49	3.95	3.55	3.19
26770CD	MXEP3	Mounting end plates for 26817	1.2 x 0.2 x 1.3	—	1.15	.99	.90	.80

Mini Pushbutton BCD Switch

- Operating temperature: -10°C to +65°C
- Switches snap together
- Positive logic ("0" all open output)
- 28VDC @ 10A
- Break before make

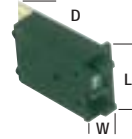

Part No.	Mfr. Cross Ref. No.	Description	Size (L" x W" x D")	Character Height	Pricing			
					1	10	100	1000
136557CD	MX061	10-position straight	.59 x .30 x 1.0	0.12"	\$3.79	\$3.41	\$3.06	

Excell Rotary DIP Switches

- Gold plated contacts to ensure reliable, low resistance connection
- Fully sealed construction
- Op force: 500g-cm max.
- Material: 94V-0 grade, UL approved fire retardant plastic
- Lead spacing: A = 0.1"; B = 0.3"
- Terminals: PC pin leads
- Life: 10,000 cycles min.
- Max. switching load rating: 25mA @ 24VDC

SALE

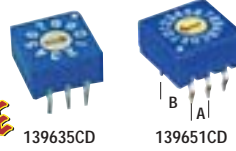

Part No.	Product No.	Position	Adjust	Code Type	W" x D" x H"	Pricing			
						1	10	50	100
139635CD	ERD110RS(DRD10)	10	top	BCD	.39 x .39 x .20	\$2.65	\$2.39	\$2.13	\$1.89
139651CD	ERD116RS	16	top	Hex	.39 x .20 x .39	2.75	2.49	2.22	1.99

Special

Rotary DIP Switches

- Fully sealed construction
- Contact and terminal material: copper alloy plated
- Make and break current rating: 30mA @ 30VDC for 10,000 cycles
- 215992CD: 0.1" x 0.3" pin spacing (standard through hole)
- 216004CD: 0.1" pin spacing (right angle through hole)
- Rotor and switch body: plastic (UL94V-0)

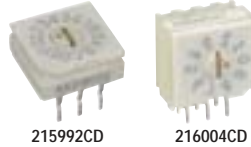

Part No.	Product No.	Position	Adjust	Code type	W" x D" x H"	Pricing			
						1	10	100	1000
215992CD	HAB16	16	Top	HEX	.39 x .39 x .20	\$2.45	\$2.10	\$1.85	\$1.55
216004CD	HAB10R	10	Side	BCD	.44 x .30 x .40	2.45	2.10	1.85	1.55

Rocker and Lever Type Switches

- Contact rating: 5A @ 120VAC; 2A @ 250VAC, except P/N 196154CD; 15A @ 125VAC; 10A @ 250VAC
- Operating temp.: -30° to 85°C
- Electrical life: 50,000 make and break cycles at full load
- Contact resistance: 10mΩ typical
- Dielectric strength: 1000Vrms @ sea level
- Insulation resistance: 10MΩ min., except P/N196154CD: 100MΩ min.

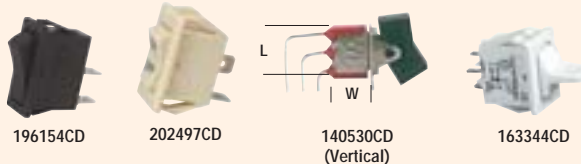

SALE

Part No.	Mfr. Cross Ref. No.	Pins	Type	Dimensions (ins.)			Lead Spacing	Lead Type	Pricing			
				L	W	D			1	10	100	1000
				196154CD	R30NSA	2			SPST on-off	1.07	.42	.77
202497CD	526VBU	2	SPST on-off	.89	.49	.64	N/A	Panel mt. quick discon.	.59	.53	.42	.32
140530CD	CK7101	3	SPDT on-on	.50	.50	.27	.150"	Right angle PC (vert.)	1.25	1.05	.89	.75
163344CD	CKD103J5W	3	SPDT on-off-on	.67	.47	.59	N/A	Panel mt. solder eyelet	.99	.89	.79	.69

We'll Send It Today!

Don't worry about backorders. Over 99% of our products are in stock!

DIP Switches

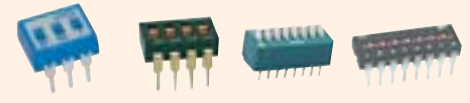

- Switch contacts: SPST
- Switches are numbered
- 50VDC @ 100mA
- Molded construction
- Standard switches have raised lever
- LP switches are flush to casing
- Pre-tinned leads

38800CD

Compatible Socket Chart, see page 129 for Sockets

Switch	Socket	Switch	Socket	Switch	Socket
109057CD	112192CD	38826CD	37161CD	101856CD	38113CD
206359CD	51570CD	38834CD	37161CD	38797CD	38607CD
38818CD	51570CD	38842CD	37372CD	38800CD	39378CD
139002CD	51570CD	139011CD	37372CD	202921CD	37372CD

Part No.	Mfr. Cross Ref. No.*	Pos.	Pricing			
			1	10	100	1000
109057CD	206-2	2	\$.75	\$.68	\$.61	\$.55
206359CD	206-3	3	.79	.65	.55	.45
38818CD	206-4	4	.79	.65	.55	.45
139002CD	206-4LP	4	.79	.70	.63	.55
38826CD	206-6	6	.99	.89	.79	.72
38834CD	206-7	7	.95	.86	.68	.50
38842CD	206-8	8	.89	.80	.72	.64
139011CD	206-8LP	8	.85	.76	.69	.48
202921CD	DIPSWRA8	8	.89	.79	.69	.62
101856CD	206-9	9	.85	.79	.69	.49
38797CD	206-10	10	.99	.79	.59	.42
38800CD	206-12	12	1.15	1.04	.95	.75

* Manufacturer may vary

Tri-State DIP Switch

- Switch contacts: bussed, tri-state
- Labeled tri-state positions (+, 0, -)
- Contact rating: 24VDC @ 25mA
- 8 positions
- Two isolated busses
- Pre-tinned leads
- Compatible socket, use P/N 37372CD, pg 129



Part No.	Mfr. Cross Ref. No.	1	10	50	100
138991CD	ETA108E	\$1.95	\$1.75	\$1.55	\$1.35

Replacement Switches for AT-Style Computer Cases

PC Pushbutton Switches

- Alternate action double pole switch
- Contacts rated at 250VAC
- UL/CSA/VDE approved
- Size: 0.9"L x 0.7"W x 0.9"D



Part No.	Description	Current	1	10	100
127044CD	PC push button	7.5A ..	\$2.49	\$2.15	\$1.59
174238CD	PC push button	8A	2.59	2.25	1.65

PC Rocker Switch

- For mini-tower cases
- DPST
- Contacts rated at 250VAC
- UL/CSA approved
- Size: 0.9"L x 1.2"W x 1.4"D

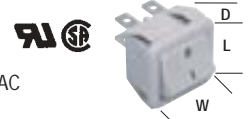

Part No.	Description	Current	1	10	100
127028CD	PC rocker	10A	\$2.95	\$2.69	\$2.39

Tactile Switches

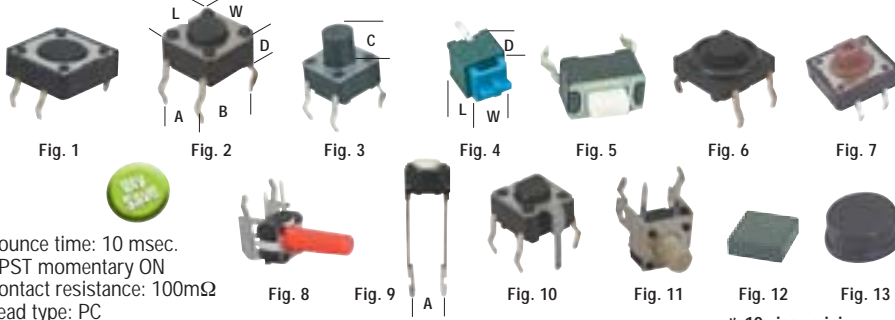

- Bounce time: 10 msec.
- SPST momentary ON
- Contact resistance: 100mΩ
- Lead type: PC

Part No.	Mfr. Cross Ref. No.*	Fig.	Pins	Dimensions (in.)			Lead Spacing		Contact Rating (mA @ VDC)	Button Color	Pricing				
				L	W	D	A	B			1	10	100	250	
122972CD	DTS1212	1	4	.47	.47	.18	—	.20	.50	20 @ 15	Black	\$.28	\$.23	\$.20	\$.18
119010CD	KTIIBICM	2	8	.24	.24	.15	0.3	.17	.25	20 @ 15	Black	.29	.26	.21	.15
149948CD	KT11P4CM	3	4	.24	.24	.15	1.7	.17	.25	20 @ 15	Black	*	.23	.21	.19
115086CD	KIE22	4	2	.24	.24	.22	—	—	.25	20 @ 15	Blue	*	.23	.14	.12
175652CD	PBS35	6	4	.31	.31	.10	—	.20	.35	20 @ 15	Black	*	.19	.16	.12
199726CD	EVQ11A04M	9	2	.24	.24	.14	0.3	.20	—	20 @ 15	White	*	.19	.17	.13
200361CD	EVQPB04K†	10	5	.24	.24	.14	0.3	.17	.26	20 @ 15	Black	.29	.25	.22	.18
137189CD	PBS103	1	4	.47	.47	.17	—	.20	.50	50 @ 12	Black	.39	.35	.32	.19
153251CD	SDT620K	2	4	.24	.24	.15	0.6	.17	.25	50 @ 12	Black	.29	.25	.20	.18
155248CD	KRS-3550-BK	5	2	.24	.14	.15	—	—	.27	50 @ 12	Black	.24	.20	.17	.17
155256CD	KRS-3550-WH	5	2	.24	.14	.15	—	—	.27	50 @ 12	White	.39	.29	.23	.16
206341CD	KPT1107A	5	2	.24	.14	.15	—	—	.25	50 @ 12	White	.39	.29	.23	.17
155379CD	KRS-1273B	7	4	.47	.47	.14	.14	.17	.53	50 @ 12	Brown	.39	.35	.31	.26
206332CD	MJTP1236E	11	2	.27	.27	.28	—	—	.18	50 @ 12	White	.39	.29	.23	.17
202956CD	KSM06330	8	2	.24	.24	.15	.38	.11	.18	50 @ 24	Red	.29	.25	.18	.18

* 10 piece minimum

Tactile Switch Caps

Part No.	Mfr. Cross Ref. No.*	Fig.	Description	Size (in.)	Material	For Use With	10	100	250
155389CD	KRS-CAP-A	12	Square	.47"L x .47"W x .16"H	Plastic	P/N 155379	\$.19	\$.17	\$.15
155408CD	KRS-CAP-B	13	Round	.5"Dia. x .25"H	Plastic	P/N 155379	.15	.13	.11

* Manufacturer may vary † 200361CD: with ground pin



B3F Series Miniature Tactile Key Switches

Miniature, low profile and easy mounting. Applications: audio, office & communications equipment, measuring instruments, TVs, VCRs, etc.

- Extended mechanical/electrical service life
- Flux-tight base structure allow automatic soldering of the key switches onto a PC board • Lead spacing: A = 0.18"; B = 0.26"



Part No.	Type	Operating Force	Dimensions (H x Pitch)	1	25	50	100
162886CD	B3F-1000	General purpose 100g	4.3 mm x 6.5 mm	\$.45	\$.40	\$.36	\$.33
188787CD	B3F-1050	High-force 260g	7.3 mm x 6.5 mm	.21	.19	.17	.16

Rotary Switches

- Panel mount • Make before break • Solder lugs • Layers: 1 • Contact rating: 30VDC @ 0.3A
- Insulation resistance: 10MΩ min. • Contact resistance: 30mΩ • Lug size: 0.07"
- Material: solid brass bushings, slotted aluminum shafts, plated frame, phenolic contact wafer (except for P/N 101565CD - plastic casing) • Mounting hole diameter: 3/8"
- Compatible with Jameco rotary knobs P/N 102787CD and 104176CD, pg 119

Includes: Washer and nut



Part No.	Mfr. Cross Ref. No.*	Poles	Position	Shaft Size (L" x Dia.")	1	10	100
101531CD	RS0261	1	12	0.46 x 0.25	\$1.39	\$1.25	\$1.12
101573CD	RS022	2	6	0.46 x 0.25	1.35	1.15	.90
101565CD	RS023	3	4	1.16 x 0.25	1.95	1.59	1.25
101557CD	RS024	4	3	0.46 x 0.25	1.09	.93	.69

* Manufacturer may vary



SP5T Rotary Switch

- Panel mount • Fixed stop • 1/8" screwdriver slotted shaft • 0.06" solder terminals
- 36° angle of throw • Single pole, 5-positions • Contact resistance: 20mΩ max.
- Insulation resistance: 1,000MΩ minimum between mutually insulated parts
- Material: stainless steel shaft and detent contact springs; brass terminals (gold plated over nickel plate); zinc, cadmium plated bushing



Part No.	Product No.	Description	1	10	100
184727CD	50AB36-01-1-5-F	SP5T panel mount rotary switch	\$3.95	\$3.39	\$2.55

4P6T Rotary Switch

- 4 poles • 6 positions
- Panel mount • 2 layers
- Contact rating: 30VDC @ 0.3A
- Insulation resistance: 10MΩ min.
- Contact resistance: 30mΩ
- Mounting hole diameter: 0.37"
- Shaft size: 0.82"L x 0.25"Dia.
- Material: solid brass bushing; solid aluminum shaft, plated frame; phenolic contact wafer



Includes: Washer and nut

Part No.	Description	1	10	100
215482CD	Rotary switch	\$1.59	\$1.45	\$1.29

16-Button Indoor/Outdoor Keypads

- 9-pin .100" headers
- Fully sealed snap-dome contact
- For indoor or outdoor use
- Contact rating: 24VDC @ 10mA resistive
- Life test: 3,000,000 cycles per key
- Compatible with MOS, TTL and DTL (10Ω max.)
- Recommended connector: P/N 103190CD header and P/N 100765CD pin, pg 127
- Size (housing): 4.7"W x 1.7"H x 0.4"T

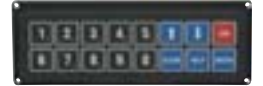

196171CD



152063CD

* Prepackaged: order in increments of 10 or 100

Part No.	Description	1	10	100
196171CD	2x8 matrix keypad	\$16.95	\$15.29	\$13.75
152063CD	4x4 matrix keypad	14.95	13.49	11.95
103190CD	Header housing (10-pin)	.42	.39	.36
100765CD	Header pin (10 per pack)	*	.11	.09

12-Button Telephone Keypads

- White plastic
- 8-pin .100" header
- Contact rating: 12VDC @ 20mA
- Contact resistance: 200Ω max.
- Tactile type keypad
- Life test: 1,000,000 cycles per key
- Size: 2.8"L x 2.2"W x 0.6"H



153488CD

Part No.	Description	1	10	100
190561CD	Numeric keypad	\$8.75	\$7.45	\$5.59
153488CD	Alpha numeric keypad	9.49	8.55	7.69

12-Button Chrome Outdoor Keypad

- 3 x 4 matrix
- Weather resistant, attack resistant keypad
- Fully sealed metal housing
- 8-pin 0.1" male headers (mating connector P/N 103202CD & 100765CD)
- Contact resistance: 100Ω max.
- Insulation resistance: 50MΩ (min.)
- Operating voltage: 24VDC @ 50mA (max.)
- Size: 4.7"H x 3.9"W x 0.5"D



Part No.	Description	1	10
226122CD	Industrial keypad	\$49.99	\$44.99

16-Button Numeric Keypad

- 4 x 4 matrix keypad
- 8-position solder pad
- Contact rating: 24VDC @ 20mA
- Contact resistance: 200Ω max.
- Life test: 1,000,000 life cycles per key
- Size: 3.0"L x 2.8"W x 0.6"H



Part No.	Description	1	10	100
169244CD	Numeric keypad	\$7.95	\$6.95	\$6.25

24VDC Liquid Level Sensors

Combine the control box and sensor to activate a water valve. When sensor is triggered by either a tank in full or empty condition, it will trigger an output status change.

176241CD: Control Box

- Input voltage: 24VDC @ 10A
- Output voltage: 24VDC @ 10A
- Size: 2.1"L x 2.1"W x 1.6"H

176250CD (Empty) / 176268CD (Full)

- Maximum contact rating: 10W
- Carry current: 1A
- Max. switching voltage: 100VDC
- Max. switching current: 0.5A
- Maximum contact resistance: 100mΩ
- Size: 2.6"L



176241CD



176250CD

Part No.	Description	1	10	25
176241CD	Control box	\$11.75	\$10.25	\$9.25
176250CD	Sensor empty type	9.95	8.95	7.95
176268CD	Sensor full type	11.45	10.30	9.27

12VDC Inductive Proximity Switch Sensors

Cylindrical and Square Styles

- Operating voltage range: 10-30VDC
- Nominal operating voltage: 12VDC
- Current consumption: 10mA max.
- Switching frequency: 1.5kHz
- Sensing target: inductive type – magnetic metal
- Sensing distance: ±10% (tin)
- Short circuit protected • LED status indicator
- Fast response • 6' long cable • Pre-tinned pigtail

155547CD (17mm)



167020CD (12mm)



155563CD (12mm)

155571CD (18mm)

Part No.	Product No.	Output Circuit	Effec. Dist. (Iron)	Standard Target (Iron) (mm)	Size (L" x W" x H")	Mounting Hole (in.)	Pricing		
							1	10	25
155547CD	S1805N1	NPN	0-4.0mm	17 x 17 x 1	1.4 x 1.4 x 0.7	0.112	\$9.95	\$8.95	\$7.95
167020CD	TS1202N1	NPN	0-1.6mm	12 x 12 x 1	1.8"L x 0.46" Dia.	0.46	20.65	18.61	16.75
155563CD	TS1202P1	PNP	0-1.6mm	12 x 12 x 1	1.8"L x 0.46" Dia.	0.46	18.95	17.09	15.35
155571CD	TS1805N1	NPN	0-4.0mm	18 x 18 x 1	1.6"L x 0.70" Dia.	0.70	29.95	25.49	19.09

GORDOS-Type Digital I/O Modules

SALE

- Industry standard package and pinout
- High immunity to false operation
- 4000Vrms optical isolation
- Continuous duty
- Color coded by function
- Capacitance: 8pF typical (input/output)



Part No.	Mfr. Cross Ref. No.	Description	Input Voltage	Output Voltage	Pricing		
					1	10	50
184541CD	ODC-5	DC output (red)	5VDC	3 to 60VDC @ 3A	\$7.29	\$6.85	\$6.39
184524CD	OAC-5	AC output (black)	5VDC	120VAC @ 3A	8.49	7.65	6.89
184583CD	IDC-5	DC input (white)	3.3 to 32VDC	5VDC	7.95	7.19	6.49



-1.1 to 2.5 PSI Pressure Sensor

- Measurable pressure range: -1.1 to 2.5 PSI
- Maximum load pressure: twice of rated pressure
- Operating voltage: 5V @ <10mA
- Maximum excitation voltage: 8V
- Pressure type: gauge pressure • Volt-level output
- Pressure media: non-corrosive gas
- On-chip amplification and temp. compensations
- Pre-calibration of offset voltage and span
- 1/8" diameter tubing is applicable
- Size: .55"L x .47"W x .20"H

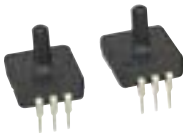

Part No.	Product No.	1	10	100
196103CD	XFPN-025-KPGRNW1	\$24.95	\$21.25	\$15.95



0 to 5 PSI Pressure Sensor

- Maximum load pressure: 10 PSI
- Output voltage: 0 – 4.5V
- Operating voltage: 5V @ 10mA
- Pressure type: gauge pressure
- Pressure media: non-corrosive gas
- Accuracy: ±0.125 PSI at 25°C; ±0.250 PSI at -10 to 65°C
- High level output, on-chip signal conditioned, temperature compensated, and calibrated
- 1/8" diameter tubing is applicable
- Size: 0.6"L x 0.5"W x 0.2"H



Part No.	Product No.	1	10	100
173657CD	XFPN-050-KPGT1	\$15.95	\$14.35	\$12.95



0 to 7 PSI Pressure Sensor

- Max. load pressure: 10.5 PSI
- Input excitation: 1.5mA
- Span output: 60-140mV
- Bridge resistance: 5kΩ ±1kΩ
- Accuracy: ±5% full scale
- High output, accuracy and stability • Low noise
- 1/8" diameter tubing is applicable
- Size: 0.5"L x 0.5"W x 0.2"H

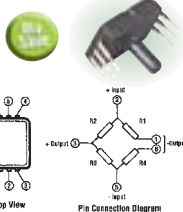

Part No.	Product No.	1	10	100
163731CD	FPM07PG	\$11.95	\$10.19	\$7.65



0 to 1.45 PSI Pressure Sensor

- Typical full scale span @ 35mV: 0-10kPa (0-1.45 PSI)
- Maximum pressure (P_{MAX}): 75kPa (10.875 PSI)
- Operating volt. (typical): 3VDC @ 6mA
- Applications: air movement control, level indicators, leak detection, robotics and industrial controls
- 1/8" diameter tubing applicable
- Size: 0.7"Dia. x 0.78"Thick (with nozzle)



Part No.	Product No.	1	10	100
218827CD	MPX10GS	\$8.99	\$8.29	\$7.49

Latched Hall Effect Sensors

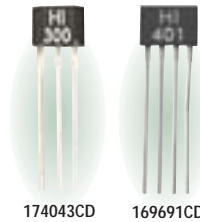

174043CD

169691CD

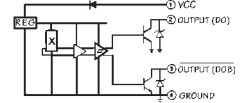

169691CD

- SP (south pole): on; NP (north pole): off
- Supply voltage: 20Vcc
- 169691CD: Complimentary open collector, output compatible with all digital logic families

Parameters	P/N 174043CD	P/N 169691CD
Supply Current	4mA	25mA
Output Current	20mA	300mA
Max. Operating Point & Max. Release Point (gauss)	≤ 130	≤ 90

Part No.	Mfr. Cross Ref. No.	1	10	100	1000
174043CD	HI-300	\$.95	\$.86	\$.77	\$.59
169691CD	HI-400	.89	.81	.72	.65

Opening an account is easy!

Corporate Customers

Call 1-800-831-4242 for details today.

General Purpose Relays

Pin Type Terminals

- DPDT • 8-pin

Series 78:
• Contact voltage: 240VAC

Series 250:
• Contact rating: 120/240VAC, 28VDC @ 10A

• Ambient temp. operating: -10°C to +50°C

• Size: 1.4"L x 1.4"W x 2.7"H

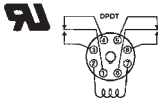

172718CD



139740CD

141145CD

Series 78 Relay

Part No.	Mfr. Cross Reference No.	P & B Cross Reference	Coil Voltage	Pricing		
				1	10	50
172718CD	SCL12DPDT	K10-11D15-R	12VDC	\$4.99	\$4.49	\$3.99

Series 250 Relays

Part No.	Mfr. Cross Reference No.	P & B Cross Reference	Coil Voltage	Pricing		
				1	10	50
139766CD	BTA1-2C-12VDC	R02-11D10-12	12VDC	\$9.49	\$8.55	\$7.69
139740CD	BTA1-2C-120VAC	R02-11A10-120	120VAC	9.95	8.79	7.99

Series 250 Sockets

Part No.	Voltage	Current	Pins	Dimensions	Pricing		
					1	10	50
141145CD	250VAC	20 amps	8	2.0"L x 1.6"W x 0.8"H	\$3.99	\$3.65	\$3.59
141153CD	250VAC	20 amps	11	2.0"L x 1.7"W x 1.2"H	5.45	5.10	4.49

Quick Connect Blade Terminal – Series 388



DPDT 3PDT

141161CD

Flat terminals (0.187" x 0.020") for standard plug-in mounting; also accepts quick-connect receptacles or direct soldering.

- Contact rating: 120VAC/28VDC @ 13A/240VAC @ 10A

• Ambient temperature operating: -30°C to +50°C

• Size: 1.5"L x 1.4"W x 2.2"H

Part No.	Mfr. Cross Reference No.	P & B Cross Reference	Coil Voltage	Style	Pins	Pricing		
						1	10	50
139854CD	BTA2-3C-24VDC	R10-14D10-24	24VDC	3PDT	11	\$8.95	\$7.75	\$6.99

Series 388 Socket

Part No.	Voltage	Pins	Amps	Dimensions	Pricing		
					1	10	50
141161CD	250VAC	11	20	3.0"L x 1.4"W x 1.0"H	\$3.95	\$3.56	\$3.20



G2R Power PCB Relays

SALE

- Operating frequency: 18,000 operations/hr. (mechanical); 1,800 operations/hr. (electrical; under rated load)

• Power consumption: approx. 530mW (non-loading DC coil); approx. 0.9 mW (non-loading AC coil)

• Service life: AC – 10,000,000 operations (min.); DC – 20,000,000 operations (min.)

• Contact voltage: 250VAC/30VDC • Contact material: AgCdO

• Insulation resistance: 1,000MΩ (min. @ 500VDC)

• Coil voltage: 120VDC

186757CD: 1.77"L x 0.55"W x 1.16"H; **186829CD:** 1.40"L x 0.51"W x 1.00"H



186757CD



186829CD



Part No.	Product No.	Type	Pins	Coil Res. Ω	Contact Current	Pricing		
						1	25	50
186757CD	G2R-1-T-AC120	SPDT quick-conn.	5	260	10A	\$6.99	\$6.29	\$5.59
186829CD	G2R-2-S-AC120	DPDT plug-in	8	6500	5A	6.45	5.79	5.25

Rayex General Purpose Relays



Potter and Brumfield Type LB2 Series

- DPDT • 8-pin
- Contact rating: 240VAC/30VDC @ 12A
- Mechanical life: 10,000,000 operations
- Electrical life: 100,000 operations min. at rated load



175564CD



175572CD

Part No.	Product No.	P & B Cross Ref.	Coil Voltage	Pricing			
				1	10	50	100
172718CD	SCL12DPDT	K10-11D15-12	12VDC	\$4.99	\$4.49	\$3.99	\$3.59
175564CD	LB2-24DS	K10-11D15-24	24VDC	5.99	5.49	4.93	4.49
175572CD	LB2-110AS	K10-11A15-120	110VAC	6.25	5.49	4.99	4.39

Rayex LB2 Socket

- DIN rail snap socket for LB2 relays



Part No.	Product No.	P & B Cross Reference	Pins	Pricing		
				1	10	50
175530CD	PTF08AA	27E895	8	\$5.95	\$5.39	\$4.85

Rayex LB4H Series

- 4PDT • 14-pin
- Insulation resistance: 1,500MΩ @ 500VDC
- Mechanical life: 10,000,000 operations
- Electrical life: 100,000 operations min. at rated load
- Contact rating: 240VAC/24VDC @ 5A; except P/N 183011CD 220VAC/24VDC @ 5A



175601CD



175610CD

Part No.	Product No.	P & B Cross Ref.	Coil Voltage	Pricing			
				1	10	50	100
183011CD	GM4PDT12DF	KHAU-17D12-12	12VDC	\$6.95	\$6.38	\$6.04	\$4.99
175601CD	LB4H-24DS	KHAU-17D12-24	24VDC	4.95	4.45	3.99	3.59
175610CD	LB4H-110AS	KHAU-17A12-120	110VAC	4.25	3.85	3.45	3.25

Rayex LB4H Socket

- DIN rail snap socket for LB4H relays



Part No.	Product No.	P & B Cross Reference	Pins	Pricing		
				1	10	50
175556CD	PYF14AA	PYF14AA	14	\$3.95	\$3.49	\$2.95

T9A Series Relay

Low Cost PC Board or Panel Mount Only

- Contact form: SPDT • Coil voltage: 12VDC
- Coil: 155Ω • Contact voltage: 240VAC/28VDC
- Contact current: 20A/10A • 5-pin
- Terminal type: 0.1" disconnect (2); 0.25" disconnect (3)
- Mechanical life expectancy is 10 million operations
- Operating temperature: -55°C to +85°C
- Dielectric strength: 1500VAC (between open contacts)
- Dimensions: 2.0"L x 1.6"W x 1.8"H

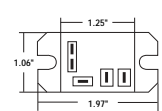

Part No.	Product No.	P & B Cross Ref.	Pricing			
			1	10	50	100
137357CD	953-IC-12DM	T9AS5D2-12	\$2.69	\$2.49	\$2.29	\$1.79

Reed Type Relay

- Manufacturer: Han Kuc
- Contact form: SPST • Coil voltage: 12VDC
- Coil: 550Ω • Contact voltage: 250VAC/150VDC
- Contact current: 0.1A • 4-pin
- Operating temperature: -35°C to +85°C
- Normally open (NO), normally closed (NC)
- Terminal type: PCB solder
- Dielectric strength: 500VDC (between contact and coil)



SALE

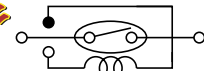

Part No.	Product No.	Dimensions	Pricing			
			1	10	50	100
111448CD	RC108T	1.0"L x .37"W x .38"H	\$0.55	\$0.49	\$0.45	\$0.39

See the yellow and green highlighted items.

Jameco Special Values!

Details on page 4.



Small High-Current PC Mount Relays

SALE

An inexpensive means of switching loads up to 30 amps. While these small, low-cost relays are designed primarily for the appliance industry and the heating, air conditioning and ventilation markets, they are also well suited for automotive load management and other applications.

- Meets UL class F insulation standard
- Mechanical life expectancy is 10 million operations
- Electrical life expectancy is 100,000 operations at rated loads
- Dielectric strength: 1500Vrms (between contact and coil)

- 104926CD: Open frame relay
- 129349CD: Immersion cleanable, plastic sealed case
- 144186CD: For use with universal relay card (P/N 128910CD, pg 208)
- 195856CD: High dielectric strength of 4kV with 8mm clearance/creepage

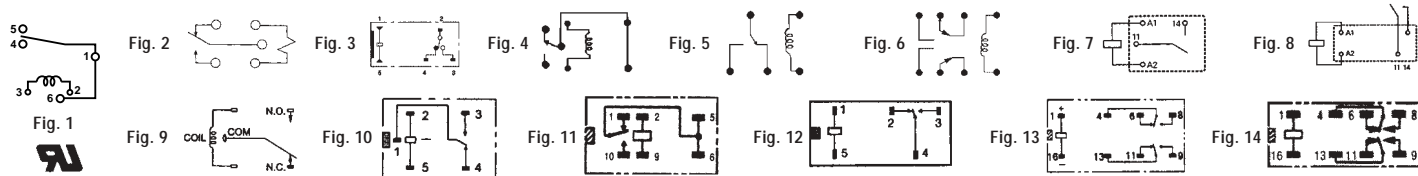

Part No.	Mfr. Cross Ref. No.	Potter & Brumfield Cross Reference	Fig.	Contact Form	Coil Voltage	Coil (Ohms)	Contact Voltage	Contact Current	Pins	L x W x H (in.)	Pricing			
											1	10	50	100
145752CD	T90S1D12-12*	T90S1D12-12	1A	SPST	12VDC	155	240VAC	30A	5	1.2 x 1.0 x .77	\$2.99	\$2.69	\$2.39	\$2.15
195864CD	RP838012	—	8F	SPST	12VDC	270	250VAC	12A	4	1.1 x .48 x 1.0	1.35	1.09	.81	.57
192778CD	TN423024	T7NS1D1-24	7C	SPST	24VDC	1600	250VAC/30VDC	7A	4	.82 x .62 x .63	1.05	.92	.84	.76
134949CD	FKD130PDC5V	T90S5D12-5	1A	SPDT	5VDC	27	240VAC/28VDC	20A	6	1.3 x 1.1 x .80	2.49	2.15	1.93	1.65
174449CD	LU-5	T81H5D215	4C	SPDT	5VDC	125	120VAC/24VDC	1A/2A	6	.60 x .40 x .45	1.89	1.75	1.63	1.55
187151CD	G5LE-1DC5	—	10H	SPDT	5VDC	63	120VAC/30VDC	10A/8A	5	.90 x .65 x .75	1.59	1.37	1.25	1.25
187240CD	G5V-1-DC5	—	11I	SPDT	5VDC	166.7	125VAC/24VDC	.5A/1A	6	.50 x .30 x .40	2.15	1.88	1.65	1.65
104926CD	733SPDT12VDC*	T90N5D12-12	1E	SPDT	12VDC	155	240VAC/28VDC	20A/10A	6	1.2 x .90 x .63	2.49	2.24	2.01	1.81
129349CD	832-IC-S	T90S5D12-12	1A	SPDT	12VDC	155	277VAC/28VDC	20A/10A	6	1.2 x 1.0 x .75	2.25	1.99	1.79	1.46
174393CD	LM1-12D	RKA5DG12	5D	SPDT	12VDC	270	250VAC/30VDC	10A	5	1.2 x .48 x 1.0	1.45	1.35	1.19	1.09
186669CD	G2R-14-DC12	—	12J	SPDT	12VDC	275	250VAC/30VDC	10A	5	1.2 x 1.0 x .51	3.19	2.75	2.55	2.35
172937CD	JS1-12V	T72M5D121-12	9G	SPDT	12VDC	400	125VAC/24VDC	10A/5A	5	.85 x .62 x .63	1.15	1.09	.95	.79
144186CD	JZC-22F	VR15M121C	2C	SPDT	12VDC	337	120VAC/28VDC	15A	5	.80 x .64 x .80	3.79	3.39	3.05	2.75
174431CD	LEG12F	T7C5SD12	2C	SPDT	12VDC	400	120VAC/24VDC	15A	5	.76 x .62 x .60	1.49	1.29	1.19	1.09
195856CD	G6R-1-DC12	—	3B	SPDT	12VDC	650	250VAC	8A	5	1.2 x .39 x .57	2.95	2.39	1.79	1.25
184461CD	G5V-1-DC12	—	11I	SPDT	12VDC	960	125VAC/24VDC	.5A/1A	6	.50 x .30 x .40	2.35	1.88	1.66	1.49
187282CD	G6A-234PSTUSDC5	—	13K	DPDT	5VDC	125	125VAC/30VDC	.3A/1A	8	.80 x .40 x .33	4.35	3.77	3.39	2.99
174377CD	LM2-12D	RKA5DZ12	6D	DPDT	12VDC	270	250VAC/30VDC	5A	8	1.2 x .48 x 1.0	2.49	2.25	1.95	1.75
187258CD	G5V-2-DC12	—	14L	DPDT	12VDC	288	125VAC/30VDC	.5A/2A	8	.81 x .40 x .45	2.68	2.41	2.17	1.95
184452CD	G5V2-DC24	—	14L	DPDT	24VDC	1152	125VAC/30VDC	.5A/2A	8	.81 x .40 x .45	2.49	2.25	1.79	1.25
200740CD	G5V-2-HIDC24	—	14L	DPDT	24VDC	1152	125VAC/30VDC	.5A/2A	8	.81 x .40 x .45	2.59	2.35	1.89	1.39

*Manufacturer may vary

Potter & Brumfield Type Plastic Enclosed Construction Relays

VF4 Type

- Dielectric strength: 500VDC (between contact & coil)
- Operating temperature: -35°C to +85°C
- Contact current: 40A
- Coil voltage: 12VDC except P/N 171521CD (5VDC)
- Normally open (NO), normally closed (NC)
- Terminal type: quick connect
- Dimensions: 1.1"L x 1.1"W x 1.0"H

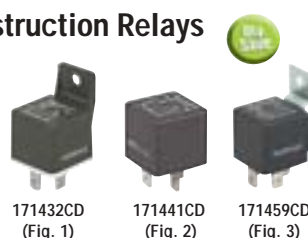
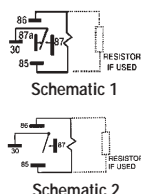

Part No.	Mfr. Cross Ref. No.	P&B Cross Reference	Fig.	Contact Form	Coil Ohms	Contact Schematic	Contact Voltage	Pins	Pricing			
									1	10	50	100
171459CD	LD1A-12F	VF481F11S01	3	SPST-NO	78	2	14VDC	4	\$1.89	\$1.75	\$1.39	\$1.05
171441CD	961A-1A12D	VF411F11	2	SPST-NO	90	2	14VDC	4	2.49	2.39	2.29	2.19
171432CD	961A-1C-12DM	VF481F11	1	SPDT	90	1	12VDC	5	2.99	2.69	2.25	1.65
171521CD	LD5F	VF445D11	1	SPDT	14	1	12VDC	5	1.69	1.35	1.05	.71
148582CD	LD12F	VF485F11	1	SPDT	78	1	12VDC	5	2.49	2.25	1.95	1.75

Relay Socket with Coil Diode

VF4 Type

- For use with P/N 148582CD, left
- 12 AWG: 2 black & 1 blue wire
- 18 AWG: 1 black & 1 red wire
- Contact voltage/current: 12V/20A
- Diode coil suppression • 7.5" wire

Part No.	Ref. No.	1	10	50	100
170624CD	RSD03	\$2.35	\$2.15	\$1.69	\$1.25



See page 134 for our **NEW** selection of Molex Power Connectors and page 130 for Amphenol Connectors

30-Day Money-Back Guarantee

If you're not completely satisfied, we'll take it back!
Details on page 217.

DC/AC and DC/DC Solid State Relays

• Screw terminal with hardware • Photo isolation • Metal mounting base • Manufacturer may vary



176698CD (Fig. 1) 153058CD (Fig. 2) 192815CD (Fig. 3) 162341CD (Fig. 4) 176735CD (Fig. 5) 173518CD (Fig. 6) 187004CD (Fig. 7) 187063CD (Fig. 8) 164996CD (Fig. 9) 127790CD (Fig. 10)

Part No.	Product No.	Mfr.	Control Voltage	Type	Contact Style	Contact Voltage	Contact Current	Pins	Fig.	Terminal Type	Agency Approval	Size L" x W" x H"	Pricing			
													1	10	50	100
Solid State Relays DC/AC Type																
153058CD	KSD203AC2	COSMO	4-32VDC	DC/AC	SPST	240VAC	3A	4	2	Solder Lead	—	1.4 x 0.3 x 0.9	\$10.95	\$9.89	\$8.89	\$7.99
139053CD	240D25	OPTO 22	3-32VDC	DC/AC	SPST	240VAC	25A	4	3	Screw Terminal	UL/CSA	2.3 x 1.7 x 1.0	21.95	19.79	17.79	16.05
162341CD	ESR51024-010	Excel	3-32VDC	DC/AC	SPST	240VAC	10A	4	4	Screw Terminal	UL	2.3 x 1.7 x 1.1	15.95	14.39	12.95	11.65
162368CD	ESR51024-025	Excel	3-32VDC	DC/AC	SPST	240VAC	25A	4	4	Screw Terminal	UL	2.3 x 1.7 x 1.1	21.95	19.79	17.79	16.05
162405CD	ESR51024-040	Excel	3-32VDC	DC/AC	SPST	240VAC	40A	4	4	Screw Terminal	UL	2.3 x 1.7 x 1.1	22.99	20.69	18.69	16.79
105081CD	615-8500	Teledyne	3-32VDC	DC/AC	SPST	250VAC	10A	4	3	Screw Terminal	UL	2.3 x 1.7 x 1.1	15.99	14.39	12.99	11.69
192815CD	KSD240AC8	COSMO	4-32VDC	DC/AC	SPST	250VAC	40A	4	3	Screw Terminal	—	2.3 x 1.8 x 0.6	22.95	19.95	17.95	15.95
175214CD	KB20C02A	Kyoto	3-32VDC	DC/AC	SPST	280VAC	2A	4	1	Solder Lead	—	1.4 x 0.3 x 1.5	6.49	5.69	5.15	4.65
127790CD	D2W202F	Crydom	3-32VDC	DC/AC	SPST	280VAC	2A	4	10	Solder Lead	UL/CSA	1.7 x 0.4 x 1.3	6.49	6.29	5.99	5.99
173518CD	RLYB4280	Phillips	3-32VDC	DC/AC	SPST	280VAC	4A	4	6	Solder Lead	—	1.7 x 0.4 x 1.5	9.95	8.95	7.99	7.25
176698CD	KB20C06A	Kyoto	3-32VDC	DC/AC	SPST	280VAC	6A	4	1	Solder Lead	—	1.4 x 0.3 x 0.9	9.99	8.99	7.99	7.19
176719CD	KD20C40AX	Kyoto	3-32VDC	DC/AC	SPST	280VAC	40A	4	5	Screw Terminal	—	2.3 x 1.7 x 0.9	19.99	17.99	16.19	14.59
176735CD	KD20C75AX	Kyoto	3-32VDC	DC/AC	SPST	280VAC	75A	4	5	Screw Terminal	—	2.3 x 1.7 x 0.9	39.95	35.99	32.39	29.15
204441CD	TD24200	Crydom	4-15VDC	DC/AC	4PST	280VAC	20A	13	—	Solder Lead	UL/CSA	2.3 x 1.8 x 0.9	56.95	48.45	36.35	36.35
186992CD	G3NA-210B-DC5-24	Omron	5-24VDC	DC/AC	—	240VAC	10A	4	7	Screw Terminal	UL/CSA	2.3 x 1.7 x 1.1	14.29	13.55	12.89	12.25
187004CD	G3NA-220B-DC5-24	Omron	5-24VDC	DC/AC	—	240VAC	20A	4	7	Screw Terminal	UL/CSA	2.3 x 1.7 x 1.1	19.95	17.95	15.95	13.95
164988CD	S101S02	Sharp	3-32VDC	DC/AC	—	125VAC	1.5A	4	9	Solder Lead	UL/CSA	0.9 x .16 x .63	3.95	3.49	2.95	2.25
164996CD	S202TA1	Sharp	3-32VDC	DC/AC	—	265VAC	2.5A	4	9	Solder Lead	UL/CSA	0.9 x .16 x .63	4.95	4.49	4.05	3.65
Solid State Relay DC/DC Type																
172591CD	KF0602D	Kyoto	3-32VDC	DC/DC	SPST	60VDC	2A	4	1	Solder Lead	—	1.4 x 0.3 x 0.9	\$9.95	\$8.95	\$7.95	\$6.95
175222CD	KF0604D	Kyoto	3-32VDC	DC/DC	SPST	60VDC	4A	4	1	Solder Lead	—	1.5 x 0.3 x 0.9	11.95	11.25	10.25	9.22
176647CD	KG1005D	Kyoto	3-32VDC	DC/DC	SPST	120VDC	5A	4	5	Screw Terminal	—	2.3 x 1.7 x 0.9	26.99	24.29	21.79	19.59
176655CD	KG1010D	Kyoto	3-32VDC	DC/DC	SPST	120VDC	10A	4	5	Screw Terminal	—	2.3 x 1.7 x 0.9	29.99	26.99	24.29	21.89

† Zero crossing

DIP Relays • Logic control levels • Long life with reliable operation • Moisture resistant • Compatible with IC sockets • Compact design/construction • Excellent for PCB applications

Schematic 1

Schematic 2

Schematic 3

Schematic 4

Schematic 5

Schematic 6

Schematic 7

Schematic 8

Part No.	Mfr. Cross Reference No.	Manufacturer	Contact Schem.	Contact Form	Coil Voltage	Coil Ohms	Contact Voltage	Contact Current	Pins	Jameco Socket	Fig.	Size L x W x H (in.)	Leads A x B x C (in.)	Pricing			
														1	10	50	100
106462CD	201A05	Excel Cell Elect.	1	SPST-NO	5VDC	500	100VDC	0.5A	8	37161	3	.78 x .25 x .20	.10 x .40 x .30	\$2.25	\$1.91	\$1.60	\$1.29
138430CD	2D1A05	Excel Cell Elect.	2	SPST-NO	5VDC	500	100VDC	0.5A	8	37161	3	.77 x .30 x .22	.10 x .40 x .30	2.29	1.95	1.65	1.34
215896CD	OJE-SS-109LMF	OEG	7	SBT-NO	9VDC	400	250VAC/30VDC	3A/3A	4	—	1	.71 x .39 x .57	.50 x .60 x .30	2.29	1.95	1.69	1.39
106471CD	201A12	Excel Cell Elect.	1	SPST-NO	12VDC	1000	100VDC	0.5A	8	37161	3	.78 x .25 x .20	.10 x .40 x .30	2.49	2.10	1.77	1.45
138448CD	2D1A1200	Excel Cell Elect.	2	SPST-NO	12VDC	1000	100VDC	0.5A	8	37161	3	.77 x .30 x .22	.10 x .40 x .30	2.25	1.95	1.75	1.49
192760CD	5MBU-5	Fujitsu	6	DPST-NO	5VDC	35	240VAC/24VDC	5A	8	—	1	1.13 x .50 x .98	.17 x .76 x .28	1.95	1.75	1.49	1.25
138456CD	202A05	Excel Cell Elect.	3	DPST-NO	5VDC	140	100VDC	0.5A	8	37161	3	.77 x .30 x .28	.10 x .40 x .30	3.49	3.15	2.69	2.19
129875CD	DS2EMDC5V*	NEC (MR62-5)	4	DPDT	5VDC	62.5	125VAC/30VDC	.6A/1A	8	37372	1	.79 x .40 x .39	.20 x .40 x .30	2.99	2.77	2.45	2.09
173913CD	AZ831-2C-5DSE	American Zettler	4	DPDT	5VDC	125	125VAC/100VDC	.5A/1.25A	8	37401	1	.79 x .38 x .44	.18 x .28 x .29	2.35	2.15	1.69	1.25
139977CD	RSB55	Shin Mei	4	DPDT	5VDC	125	120VAC/30VDC	1A/2A	8	37372	1	.79 x .39 x .37	.20 x .40 x .30	2.49	2.25	1.95	1.75
99338CD	LM12C00	Clare	4	DPDT	6VDC	71	125VAC/100VDC	2A	8	37372	1	.79 x .40 x .43	.20 x .40 x .30	2.49	2.25	1.79	1.35
99311CD	DS2Y-S-DC12V*	Aromat (NAIS)	4	DPDT	12VDC	720	110VAC/30VDC	.3A/1A	8	37372	1	.79 x .40 x .43	.20 x .40 x .30	2.49	2.31	2.05	1.75
99901CD	LX200D00	Clare	4	DPDT	12VDC	720	125VAC/100VDC	2A	8	37372	1	.79 x .40 x .30	.20 x .40 x .30	6.95	6.25	5.63	4.49
99320CD	LM12E00*	NEC	4	DPDT	24VDC	1110	125VAC/100VDC	2A	8	37372	1	.79 x .40 x .43	.20 x .40 x .30	2.95	2.69	2.39	2.15
136549CD	DS4E-M-DC5V*	Aromat	5	4PDT	5VDC	62.5	125VAC/30VDC	.6A/2A	14	112299	2	1.40 x .40 x .36	.20 x .30 x .30	5.49	4.95	4.45	4.05
176313CD	DS4E-M-DC12V	Aromat	5	4PDT	12VDC	360	125VAC/30VDC	.6A/2A	14	112299	2	1.40 x .40 x .36	.20 x .30 x .30	7.95	7.15	6.45	5.79
206543CD	DS4E-S-DC5V-1C-N137	Aromat	6	4PDT	5VDC	125	250VAC/220VDC	2A	14	112299	2	1.40 x .40 x .42	.20 x .30 x .30	8.95	7.95	7.15	6.49
215909CD	RKA-7D2-12	P & B	8	DPST-NO	12VDC	270	250VAC/24VDC	5A/5A	6	—	1	1.13 x .49 x .97	.20 x .80 x .30	2.29	1.95	1.69	1.39

*Manufacturer may vary

Component Grab Bags



135394CD – Electrolytic 135271CD – LEDs 169578CD – Photocells 18294CD – Toy Motors 149649CD – Fans 55968CD – Spacers 81701CD – Cabinet

* LB grab bag quantities are approximate • Opened grab bags are not returnable • Use our 20-drawer cabinet w/ labels to store your components, P/N 81701CD, pg 119

Shaded in purple on this page you will find Jameco's nine most popular component Grab Bags. They are all individually bagged, and are combined to make up the Schwab's School Selection (P/N 163213CD) referenced towards the bottom of the page.

Capacitors

Part No.	Cross Ref. No.	Description	Wt. (lbs.)	1	10	25
17857CD	GB100	200 asst. ceramic disc capacitors	0.2 ..	\$4.95	\$4.49	
135335CD	GB100LB*	1 lb. (813 pcs) asst. ceramic disc caps.	1.0 ..	12.95	11.49	
17881CD	GB101	100 assorted mylar capacitors	0.3	5.95	5.35	
135458CD	GB101LB*	1 lb. (440 pcs) asst. mylar capacitors	1.0 ..	14.95	13.49	
17911CD	GB102	100 assorted electrolytic capacitors radial, axial, snap	0.5	4.95	4.49	
135394CD	GB102LB*	1.5 lb. assorted (300 pcs) electrolytic caps. radial, axial, snap (photo above)	1.5 ..	12.95	11.49	
17945CD	GB103	100 assorted tantalum capacitors (dipped epoxy and solid tubular)	0.1	9.95	8.95	

Diodes, Transistors and Crystals/Oscillators

Part No.	Cross Ref. No.	Description	Wt. (lbs.)	1	10	25
17961CD	GB107	200 assorted diodes (zener, switching, silicon)	0.1 ...	\$5.95	\$5.35	\$4.79
18171CD	GB127	100 assorted transistors (NPN, PNP, power)	0.1	5.95	5.35	4.79
114446CD	GB150	50 assorted crystals/oscillators	0.2	7.95	6.95	6.25

Trimmer and Single-Turn Potentiometers

Part No.	Cross Ref. No.	Description	Wt. (lbs.)	1	10	25
18075CD	GB113	100 asst. 1/10W to 1/8W trimmer pots (100Ω to 2MΩ values)	0.1 ..	\$6.95	\$6.25	
18278CD	GB174	100 assorted 1/4W & 1/2W single turn pots (100Ω to 5MΩ assorted values)	0.2	6.95	6.25	
135407CD	GB174LB*	1 lb. (295 pcs) 1/4W & 1/2W single turn pots (100Ω to 5MΩ assorted values)	1.0 ..	15.95	14.39	

Integrated Circuits and Sockets

Part No.	Cross Ref. No.	Description	Wt. (lbs.)	1	10	25
17996CD	GB108	100 assorted 7400, 74LS00 series (74, 74C, 74F, 74S, 74ALS, 74HC, 74HCT)	0.2 ..	\$6.95	\$6.25	
135280CD	GB108LB*	1 lb. (400 pcs) asst. 7400, 74LS00 series (74, 74C, 74F, 74S, 74ALS, 74HC, 74HCT)	1.0 ..	16.95	14.95	
18024CD	GB109	100 asst. linear series (LM300, 500, 700, 7800, 7900 reg.) DIP, TO-3, TO-220	0.6	7.95	6.95	
145242CD	GB109LB*	2 lb. (300 pcs) asst. linear series (LM300, 500, 700, 7800, 7900 reg.)	2.0 ..	16.95	14.95	
114964CD	GB171	100 asst. microprocessor series (micros, PALS, RAMs, PROMs, EPROMs)	0.7	7.95	6.95	
105620CD	GB120	100 asst. IC sockets (DIP IC, PGA, TO-3)	0.3	5.95	5.35	
135386CD	GB120LB*	1 lb. (260 pcs) assorted IC sockets (DIP IC, PGA, TO-3)	1.0 ..	12.95	11.49	

Surprise Computer Products Grab Bag

Various electronic components (capacitors, connectors, sockets, LEDs, resistors, diodes, ICs, transistors, pots, oscillators/resonators, inductors, crystals, switches), cables, power supply, transformer, fan, PC board, keyboard, misc. computer products.



Part No.	Cross Ref. No.	Description	Wt. (lbs.)	1	10	25
18331CD	GB190	Component/computer grab bag	20.0	\$17.95	\$15.95	

Best Bargain!

LEDs and Displays

Part No.	Cross Ref. No.	Description	Wt. (lbs.)	1	10	25
18041CD	GB110	100 assorted sizes & colored LEDs (T1/T1 ³ / ₄ round and rectangular)	0.1 ..	\$6.95	\$6.29	\$5.65
18323CD	GB186	500 asst. sizes #18041CD LEDs	0.3 ..	19.95	17.95	15.95
135271CD	GB110LB*	1 lb. (1900 pcs) asst. #18041CD LEDs	1.0 ..	44.95	40.95	38.95
18201CD	GB162	50 asst. sizes of colored displays (7-segment LED, modules, stick)	0.5	6.95	5.95	7.95

1/4W, 1/2W Resistors and Photocells

Part No.	Cross Ref. No.	Description	Wt. (lbs.)	1	10	25
18104CD	GB116	200 asst. 1/4W resistors (5/10%)	0.1 ...	\$5.49	\$4.95	
135351CD	GB116LB*	1 lb. (2000 pcs) asst. 1/4W resistors	1.0 ...	14.95	13.49	
18139CD	GB117	200 asst. 1/2W resistors (5/10%)	0.2	5.95	5.35	
169578CD	GB125	100 asst. values photocells	0.2 ...	12.95	11.49	

Switches, Toy Motors and Fans

Part No.	Cross Ref. No.	Description	Wt. (lbs.)	1	10	25
18235CD	GB165	50 assorted switches (toggle, push button, rocker, slide)	0.4 ...	\$8.75	\$7.69	
135378CD	GB165LB*	1 lb. (135 pcs) asst. #18235CD switches	1.0 ...	18.95	16.95	
18294CD	GB182	5 asst. toy DC motors (1.5–24V)	1.1	5.49	4.95	
149649CD	GB193	5 asst. AC/DC fans (photo above)	4.5	8.75	7.69	

Hardware Assortments

• 2-56 • 4-40 • 6-32 • 8-32 • Screws • Plastic Nuts • Washers • Steel • Brass • Lock Washers • Aluminum

Part No.	Cross Ref. No.	Description	Wt. (lbs.)	1	10	25
171571CD	GB149*	1 lb. (500 pcs) asst. types of screws, nuts, washers & lock washers	1.0	\$5.95	\$5.35	\$4.79
171635CD	GB149LB*	3 lbs. (1400 pcs) asst. types; same as P/N 171571CD (above)	3.0	12.95	11.49	9.95

Spacers and Standoffs Assortments

• Round • Hex • Aluminum • Brass • Steel • Plastic • Nylon

Part No.	Cross Ref. No.	Description	Wt. (lbs.)	1	10	25
166481CD	GB440	100 asst. 4-40 spacers/standoffs	0.5 ..	\$6.95	\$6.25	\$5.59
166490CD	GB632	100 asst. 6-32 spacers/standoffs	0.5	6.95	6.25	5.59
55968CD	GB140	100 asst. 4-40, 6-32, 8-32 round/hex, alum/brass/nylon spacers	0.3	7.95	6.95	6.25
135423CD	GB140LB*	1 lb. (310 pcs) same as P/N 55968CD	1.0 ..	17.95	15.95	13.95

Schwab's School Selection

Jameco's nine most popular Grab Bags (highlighted on this page) are all individually bagged. North Dakota Engineer, Loren Schwab, recommended this selection of products as a standard item. He also recommended a 20-drawer component cabinet with labels (81701CD photo above) for storage. **What's your suggestion?**

Includes: Ceramic and electrolytic capacitors, diodes, transistors, potentiometers, switches, LEDs, 1/4W resistors, spacers and standoffs.

Part No.	Cross Ref. No.	Description	Wt. (lbs.)	1	10	25
163213CD	GB197	Schwab's School Selection	3.3	\$39.95	\$34.95	
81701CD	CAB20	20-drawer component cabinet	4.7	15.95	13.95	

\$56.63 Value



Surprise Component Grab Bag

Axial and radial electrolytics, monolithic, dipped silver mica and mylar capacitors, connectors, sockets, thermistors, LEDs, resistor networks, diodes, ICs, standoffs, transistors, oscillator/resonators, inductors, crystals, resistors, pots and switches (1075 pcs).

Our Best Seller!



Part No.	Cross Ref. No.	Description	Wt. (lbs.)	1	10	25
135263CD	GB191LB*	3 lbs. electronic components	\$17.95	\$15.95	\$13.95

Component Cabinet Kits



Kits include the Most Popular Components and a Cabinet with extra drawers for your Customized Expansion

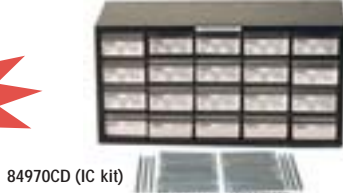

84970CD (IC kit)

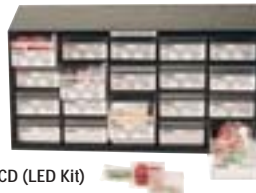

84996CD (LED Kit)

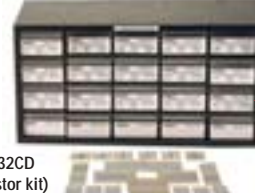

81832CD
(Resistor kit)



Each Kit includes a 20-Drawer Component Cabinet (81701CD), 20 clear plastic drawers (85454CD), 20 clear dividers (85446CD), 30 adhesive labels for drawers to identify parts in kit, and all the Electronic Components listed in each kit.

• Cabinet size: 6.0"L x 15.0"W x 7.9"H • Drawer size: 5.5"L x 2.7"W x 1.5"H • Weight: 4.6-6.4 lbs. • Cabinet: ABS-Black • Cabinet is wall-mountable or free standing

Each Refill Package includes all Electronic Components listed in each kit; each type is separately packaged.

4000 Series CMOS IC Kit

Includes 300 pcs. (25 types) CD4000 Series Integrated Circuits

SAVE \$36

10 each	10 each	10 each	10 each	20 each
CD4015	CD4024	CD4051	CD4093	CD4001
CD4016	CD4027	CD4069	CD4511	CD4011
CD4017	CD4040	CD4070	CD4538	CD4013
CD4020	CD4046	CD4071	CD4543	CD4049
CD4023	CD4050	CD4081	CD4584	CD4066

Part No.	Description	Wt. (lbs.)	1	10
84970CD	300 pcs. 4000 series CMOS IC kit	6.1	\$79.95	\$71.95
130403CD	Refill for 84970CD (300 pcs.)	1.4	58.95	52.95

7400 Series IC Kit

Includes 350 pcs. (30 types) 7400 (TTL) Integrated Circuits

SAVE \$71

10 each	10 each	10 each	10 each	10 each	20 each
7402	7416	7438	74107	74157	7400
7405	7417	7447	74123	74160	7404
7408	7420	7470	74132	74174	7406
7410	7430	7485	74151	74175	7407
7414	7432	7495	74153	74279	7474

Part No.	Description	Wt. (lbs.)	1	10
84953CD	350 pcs. 7400 IC kit	6.2	\$139.95	\$125.95

74LS Series IC Kit

Includes 420 pcs. (35 types) 74LS (TTL) Integrated Circuits

SAVE \$45

10 each	10 each	10 each	10 each	20 each
74LS05	74LS73	74LS125	74LS193	74LS00
74LS10	74LS75	74LS139	74LS240	74LS02
74LS11	74LS85	74LS151	74LS244	74LS04
74LS14	74LS86	74LS155	74LS245	74LS08
74LS20	74LS90	74LS157	74LS273	74LS32
74LS30	74LS93	74LS174	74LS373	74LS74
74LS47	74LS123	74LS175	74LS374	74LS138

Part No.	Description	Wt. (lbs.)	1	10
84961CD	420 pcs. 74LS IC kit	6.7	\$119.99	\$107.99
130391CD	Refill for 84961CD (420 pcs.)	2.0	99.99	89.99

Linear Series IC Kit

Includes 480 pcs. (40 types) Linear Series Integrated Circuits

SAVE \$60

10 each	10 each	10 each	10 each	20 each
TL072CP	LM337T	LF412CN	ULN2803A	LM317T
TL074CN	LF353N	LMC555CN	NE5532	LM324N
TL082CP	LF356N	LM556N	7808T	LM339N
TL084CN	LM358N	LM723CN	78L12	LM741CN
MAX232CPE	LM386N-1	LM1458N	7815T	LM555CN
LM301N	LM386N-3	LM1488N	7905T	7805T
LM308N	LM393N	LM1489N	7912T	78L05
LM311N	LF411CN	ULN2003A	7915T	7812T

Part No.	Description	Wt. (lbs.)	1	10
84988CD	480 pcs. Linear IC kit	6.0	\$189.95	\$169.95
130411CD	Refill for 84988CD (480 pcs.)	1.3	179.99	159.99

Low Profile IC Socket Kit

Includes 300 pcs. (10 types) Solder tail (Tin) IC Sockets

SAVE \$18

10 each	20 each	20 each	50 each	50 each
22LP	18LP	28LP	8LP	16LP
24SLP	24LP	40LP	14LP	20LP

Part No.	Description	Wt. (lbs.)	1	10
85075CD	300 pcs. LP IC Socket kit	5.5	\$31.95	\$27.95

LEDs & LED Mounting Hardware Kit

See pages 94 & 96 for photos and specs.

SAVE \$39

Includes 560 pcs. (20 types) LEDs and mounting hardware

10 each	10 each	10 each	10 each	100 each
LVG2043	HPQLMPD141	LSG2040	LG3330	LMH100
LH2043	CLF280CTP	LY2040	LY3330	LMH200
LT0333-41	LTL-425B	LA93B/G-1	LFH3360	LR2040
LG3333	LHG3392	LA93B/H-1	LEG3362	LR3330

Part No.	Description	Wt. (lbs.)	1	10
84996CD	560 pcs. LED & Hardware kit	5.0	\$59.95	\$49.95

1/8-Watt Carbon Film Resistor Kit

Includes 540 pcs. (30 values) 1/8-watt 5% Resistors

SALE

10 each	10 each	10 each	10 each	10 each	10 each	50 each	50 each
10Ω	330Ω	1.5kΩ	3.3kΩ	15kΩ	47kΩ	100Ω	4.7kΩ
47Ω	390Ω	2Ω	5.1kΩ	22kΩ	470kΩ	220Ω	10kΩ
150Ω	470Ω	2.2kΩ	5.6kΩ	27kΩ	1MΩ	1kΩ	100kΩ
270Ω	680Ω	2.7kΩ	6.8kΩ	33kΩ	10MΩ		

Part No.	Description	Wt. (lbs.)	1	10
108329CD	540 pcs. 1/8-watt Resistor kit	4.9	\$24.95	\$22.49
108302CD	Refill for 108329CD (540 pcs.)	0.2	12.95	11.49

1/4-Watt Carbon Film Resistor Kit

Includes 540 pcs. (30 values) 1/4-watt 5% Resistors

10 each	10 each	10 each	10 each	10 each	10 each	50 each	50 each
10Ω	330Ω	1.2kΩ	2.7kΩ	15kΩ	47kΩ	100Ω	4.7kΩ
47Ω	390Ω	1.5kΩ	3.3kΩ	20kΩ	470kΩ	220Ω	10kΩ
150Ω	470Ω	2kΩ	5.1kΩ	22kΩ	1MΩ	1kΩ	100kΩ
270Ω	680Ω	2.2kΩ	5.6kΩ	33kΩ	10MΩ		

Part No.	Description	Wt. (lbs.)	1	10
81832CD	540 pcs. 1/4-watt Resistor kit	4.9	\$27.95	\$24.95
103165CD	Refill for 81832CD (540 pcs.)	0.2	12.95	11.49

1/2-Watt Carbon Film Resistor Kit

Includes 540 pcs. (30 values) 1/2-watt 5% Resistors

10 each	10 each	10 each	10 each	10 each	10 each	50 each	50 each
10Ω	330Ω	1.5kΩ	3.3kΩ	15kΩ	47kΩ	100Ω	4.7kΩ
47Ω	390Ω	2kΩ	5.1kΩ	22kΩ	470kΩ	220Ω	10kΩ
150Ω	470Ω	2.2kΩ	5.6kΩ	27kΩ	1MΩ	1kΩ	100kΩ
270Ω	680Ω	2.7kΩ	6.8kΩ	33kΩ	10MΩ		

Part No.	Description	Wt. (lbs.)	1	10
107879CD	540 pcs. 1/2-watt Resistor kit	5.1	\$29.95	\$26.95
107852CD	Refill for 107879CD (540 pcs.)	0.4	14.95	13.49

Kits include the Most Popular Components and a Cabinet with extra drawers for your Customized Expansion



81875CD (Capacitor Kit)

Each Kit includes a 20-Drawer Component Cabinet (81701CD), 20 clear plastic drawers (85454CD), 20 clear dividers (85446CD), 30 adhesive labels for drawers to identify parts in kit, and all the Electronic Components listed in each kit.

20-drawer component cabinet with every kit!

- Cabinet size: 6.0"L x 15.0"W x 7.9"H
- Cabinet: ABS-Black
- Drawer size: 5.5"L x 2.7"W x 1.5"H
- Weight: 4.6 to 6.4 lbs.
- Cabinet is wall-mountable or free standing

Each Refill Package includes all Electronic Components listed in each kit; each type is separately packaged.

Need a refill? Just call 1-800-831-4242



108433CD (Hardware Kit)

1/2-Watt Single Turn Cermet Pot Kit

See page 90 (63P Series) for photos and specs.

Includes 100 pcs. (10 values) 1/2-watt Linear Taper Potentiometer

10 each	10 each	10 each	10 each	10 each
63P500Ω	63P5kΩ	63P500kΩ	63P1kΩ	63P50kΩ
63P2kΩ	63P20kΩ	63P1MΩ	63P10kΩ	63P100kΩ
Part No.	Description	Wt. (lbs.)	1	10
85032CD	100 pcs. single turn Pot kit	4.9	\$65.95	\$58.95

SAVE \$15

3/4-Watt 15 Turn Cermet Pot Kit

See page 90 (43P Series) for photos and specs.

Includes 100 pcs. (10 values) 3/4-watt Linear Taper Potentiometer

10 each	10 each	10 each	10 each	10 each
43P500Ω	43P5kΩ	43P500kΩ	43P1kΩ	43P50kΩ
43P2kΩ	43P20kΩ	43P1MΩ	43P10kΩ	43P100kΩ
Part No.	Description	Wt. (lbs.)	1	10
85041CD	100 pcs. 15 turn Pot kit	4.9	\$87.95	\$78.95

SAVE \$27

Switch Assortment Kit

See pages 100, 101, 103 & 104 for photos and specs.

Includes 150 pcs. (15 types) Pushbutton, Slide, Dip & Toggle Switches

10 each	10 each	10 each	10 each	10 each
206-4	JMT121	JMT223	MPC221	MS103
206-8	JMT123	MPC121	MPC223	SDTX620K
JMT113	JMT221	MPC123	MS102	SW153
Part No.	Description	Wt. (lbs.)	1	10
85059CD	150 pcs. Switch kit	5.0	\$98.95	\$88.95

SAVE \$53

Hardware and Spacer Assortment Kit

Includes 2300 pcs. (23 types) Spacers, Nuts, Flat, Tooth & Lock Washers and Slotted PH Screws

100 each	100 each	100 each	100 each	100 each	100 each
Spacers	Hex nuts	Flat	Int. tooth	Split lock	PH machine screws
—	2-56	—	—	#2	2-56 x 1/4, —
4-40	4-40	#4	#4	#4	4-40 x 1/4, 1/2
6-32	6-32	#6	#6	#6	6-32 x 1/4, 1/2
8-32	8-32	#8	#8	#8	8-32 x 1/2, —
Part No.	Description	Wt. (lbs.)	1	10	
108433CD	2300 pcs. Hardware kit	7.5	\$59.95	\$53.95	
130497CD	Refill for 108433CD (2300 pcs.)	2.7	39.95	35.95	

SAVE \$31

Ceramic Disc Capacitor Kit

Includes 520 pcs. (10 values) 50V ±20% Ceramic Disc Capacitors

20 each	20 each	20 each	100 each	100 each
10pF	47pF	470pF	.022μF	.01μF
22pF	100pF	.001μF	.047μF	.1μF
Part No.	Description	Wt. (lbs.)	1	10
81859CD	520 pcs. Ceramic Capacitor kit	5.0	\$32.95	\$29.95
130232CD	Refill for 81859CD (520 pcs.)	0.3	17.95	16.49

SAVE \$19

Monolithic Ceramic Capacitor Kit

Includes 280 pcs. (10 types) 50V ±20% Monolithic Ceramic Capacitors

10 each	10 each	10 each	10 each	100 each
22pF	.001μF	.047μF	.47μF	.01μF
100pF	.0022μF	.22μF	1μF	.1μF
Part No.	Description	Wt. (lbs.)	1	10
171475CD	280 pcs. Monolithic Cap kit	5.0	\$34.99	\$31.49
171483CD	Refill for 171475CD (280 pcs.)	0.3	17.95	15.95

SAVE \$9

Radial Electrolytic Capacitor Kit

Includes 240 pcs. (15 values) ±20% Radial Electrolytic Capacitors

10 each	10 each	20 each	20 each	20 each
100μF @ 50V	1000μF @ 16V	1μF @ 50V	3.3μF @ 50V	22μF @ 50V
220μF @ 25V	2200μF @ 25V	1μF @ 100V	4.7μF @ 50V	47μF @ 50V
470μF @ 25V	3300μF @ 25V	2.2μF @ 50V	10μF @ 50V	100μF @ 25V
Part No.	Description	Wt. (lbs.)	1	10
81867CD	240 pcs. Radial Cap. kit	5.3	\$32.95	\$29.95
130331CD	Refill for 81867CD (240 pcs.)	0.5	17.95	16.49

SAVE \$9

Axial Electrolytic Capacitor Kit

Includes 140 pcs. (10 values) ±20% Axial Electrolytic Capacitors

10 each	10 each	10 each	20 each	20 each
47μF @ 50V	220μF @ 50V	1000μF @ 25V	1μF @ 50V	10μF @ 50V
100μF @ 50V	470μF @ 50V	2200μF @ 16V	4.7μF @ 50V	2.2μF @ 50V
Part No.	Description	Wt. (lbs.)	1	10
81875CD	140 pcs. Axial Capacitor kit	5.3	\$39.99	\$35.99
130340CD	Refill for 81875CD (140 pcs.)	0.6	24.95	22.49

SAVE \$13

Mylar Capacitor Kit

Includes 280 pcs. (10 values) 100V ±10% Mylar Capacitors

10 each	10 each	10 each	10 each	100 each
.001μF	.022μF	.047μF	.47μF	.01μF
.0047μF	.033μF	.22μF	1μF	.1μF
Part No.	Description	Wt. (lbs.)	1	10
81883CD	280 pcs. Mylar Capacitor kit	5.1	\$39.99	\$35.99
130358CD	Refill for 81883CD (280 pcs.)	0.3	19.95	17.95

SAVE \$10

Dipped Tantalum Capacitor Kit

Includes 150 pcs. (15 values) ±20% Dipped Tantalum Capacitors

10 each	10 each	10 each	10 each	10 each
.1μF @ 35V	1μF @ 25V	3.3μF @ 35V	10μF @ 16V	22μF @ 16V
.22μF @ 35V	1μF @ 35V	4.7μF @ 35V	10μF @ 35V	33μF @ 25V
.47μF @ 35V	2.2μF @ 16V	6.8μF @ 35V	15μF @ 25V	47μF @ 25V
Part No.	Description	Wt. (lbs.)	1	10
81841CD	150 pcs. Tantalum Capacitor kit	4.8	\$74.95	\$67.95
130260CD	Refill for 81841CD (150 pcs.)	0.3	59.95	53.95

SAVE \$50

Transistor Assortment Kit

See page 78-79 for photos and specs.

Includes 560 pcs. (20 types) NPN, PNP (High/Medium/Low Power) Transistors

10 each	10 each	10 each	10 each	100 each
2N2222A	2N4401	MJE3055T	TIP31A	2N3904
2N2907A	2N4403	MPF102	TIP32A	2N3906
2N3053	2N5951	MPSA06	TIP102	PN2222
2N3055	2N7000	MPSA13	TIP120	PN2907
Part No.	Description	Wt. (lbs.)	1	10
82595CD	560 pcs. Transistor kit	5.1	\$87.95	\$78.95
130374CD	Refill for 82595CD (560 pcs.)	0.4	77.95	69.95

SAVE \$12

Diode Assortment Kit

See pages 79-80 for photos and specs.

Includes 420 pcs. (15 types) Zener, Switching and Silicon Rectifiers

10 each	10 each	10 each	10 each	100 each
1N270	1N4001	1N4735	1N5408	1N914
1N751	1N4007	1N4742	C106B1	1N4004
1N3600	1N4733	1N5404	KBPO4M	1N4148
Part No.	Description	Wt. (lbs.)	1	10
82587CD	420 pcs. Diode kit	5.0	\$43.95	\$39.95
130366CD	Refill for 82587CD (420 pcs.)	0.3	28.95	26.49

Solderless Breadboards, Prototype Boards & Accessories



These long-lasting solderless breadboards feature screen-printed color coordinates suitable for many types of digital and analog prototyping and circuit design. Larger models feature a heavy-duty aluminum backing with binding posts. Use Jameco's AC/DC breadboard power supply, P/N 77681CD (pg 115).

- Accepts most electronic components, including integrated circuits and transistors for digital and/or analog circuitry • 0.1" hole spacing
- Pins are identified by numbered rows and columns
- Ideal for high frequency and low noise circuits
- One-year warranty * WBU5 and JE series do not interconnect



20757CD



20773CD



20790CD



20811CD



20600CD

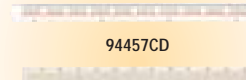

94457CD



20669CD



20722CD



136901CD



77825CD

Attention Educators! Buy jumper wire (pg 115) in bulk and SAVE! (see Hook-up Wire on page 121)

WBU5 Series Key Features:

- Horizontal assembly corresponds to the operation flow design of the PC boards for handy operation
- Round hole design makes the electric connection better
- Formed with V-shaped cross-sectional groove, which allows DIP IC pins to be inserted across two parts and to increase the rate of utilization due to small pitch
- Dovetail protrusions and recesses designed to connect two adjacent parts tightly together

JE Series Key Features:

- Use to breadboard and debug circuit designs
- Low static, plastic body – CMOS safe
- Nickel-plated clips designed to withstand up to 5,000 insertion cycles
- Breadboard strips connect together to form larger working areas
- Components are easily interconnected using 20-28 AWG wire (P/N 19289CD & 20079CD, pg 115)
- Some models feature heavy-duty aluminum backings (JE24, JE27, WBU504)

Part Number	Product Number*	Terminal Strips	Bus Strips	Contact Points	Binding Posts	Breadboard Size L x W (In.)	Baseplate Size L x W (In.)	Weight (lbs.)	Pricing			
									1	10	50	100
94457CD	JE19	0	1	100	0	6.5 x 0.4	—	0.04	\$2.95	\$2.65	\$2.39	\$2.15
20600CD	JE21	1	2	400	0	3.3 x 2.1	—	0.13	4.95	4.49	3.95	3.49
20669CD	JE22	1	0	630	0	6.5 x 1.4	—	0.20	5.49	4.95	4.49	3.95
194280CD	JE35	1	1	740	0	6.9 x 2.1	—	0.23	9.95	8.99	8.09	7.25
194298CD	JE37	1	2	840	0	6.9 x 2.4	—	0.25	9.95	8.95	7.95	7.25
194255CD	JE38	1	2	970	4	2.9 x 5.6	4.9 x 6.3	0.50	16.95	15.25	13.75	12.35
20722CD	JE23	1	2	830	0	6.5 x 4.0	6.5 x 2.1	0.30	8.95	7.95	7.25	6.55
194271CD	JE34	2	3	1,560	3	6.5 x 4.0	8.5 x 4.7	0.73	15.95	14.39	12.95	11.65
20757CD	JE24	2	1	1,360	2	6.5 x 3.1	8.5 x 4.0	0.60	12.95	11.95	10.95	9.95
136901CD	WBU504*	2	3	1,855	4	5.5 x 5.5	7.4 x 6.3	0.90	22.99	20.99	18.99	16.99
20773CD	JE25	2	4	1,660	3	6.5 x 4.3	8.5 x 5.1	0.80	18.95	16.95	14.95	13.95
20790CD	JE26	3	5	2,390	4	6.9 x 5.8	9.1 x 6.9	1.10	25.95	23.39	21.05	18.95
20811CD	JE27	4	7	3,220	4	7.3 x 7.5	9.5 x 8.3	1.40	31.95	29.95	27.95	25.95

Part No.	Description	1	10	25
77825CD	Breadboard pin to breadboard pin test leads (20 pk), 4 each color-coded (red, yellow, blue, black, white), 20 AWG wire, 5.9"L (15cm)	\$12.95	\$11.69	\$10.49

PLCC Prototype Adapters

PLCC socket mounted on a circuit board for easy wire wrap or design prototyping. Solder masked PCB with 0.25" long leads.



73550CD

- PCB construction
- Silkscreen numbers identify pin numbers in groups of 5 and 10 • Gold-plated round pins
- Tin-plated PLCC connector
- PLCC socket identifies pin 1 and orientation key
- PLCC socket slotted for PLCC chip remover

Part No.	Pins	Size (L x W)	1	10	100
73541CD	44	2.3" x 1.6" ...	\$11.95	\$10.79	\$9.69
73550CD	68	3.4" x 1.6"	15.95	14.49	12.95
73568CD	84	4.3" x 1.9"	23.95	21.59	19.45

PCI-Bus Extender Card

- PCI Bus
- Extends life of motherboard connectors
- Gold-plated fingers for long life
- Size: 5.9"L x 5.4"W



Part No.	Description	1	10
141381CD	PCI-bus extender card	\$74.95	\$67.49

BestProto AT/ISA Prototyping Board

- Can accommodate a PGA package with a 31 x 31mm footprint
- Twenty-one 1206 surface-mount bypass capacitor sites and 142 unconnected sites
- Size: 8.2"L x 4.2"W



Low noise power and ground planes

Includes: Signal definition chart

Part No.	Description	1	10	25
136469CD	AT/ISA protoboard	\$24.95	\$22.49	\$20.25

PCI-Bus Prototype Board

- All plated through holes
- 0.1" hole spacing
- 50 Mil power and ground grids
- Provision for wire wrap and bypass caps
- Impedance matched to bus specifications
- Easy access to every signal on the bus
- Size: 12.4"L x 5.0"W • Weight: 0.6 lbs.



SALE

Part No.	Description	1	10
141372CD	PCI prototype bus board	\$74.95	\$67.49

8/16-Bit PC/XT/AT Solderless Plug-In Breadboard



- IBM PC/XT/AT and higher compatible
- 62 data I/O lines and a DB25 female connector for interfacing to peripherals
- Twenty-four 14-pin IC capacity
- Clearly labeled bus lines • 2,352 contact points
- Durable construction • One-year warranty
- Size: 13.8"L x 5.0"W • Weight: 1.0 lb.

Easy PC/XT/AT Prototyping!

Part No.	Description	1	10	25
81672CD	8/16-bit breadboard	\$59.95	\$53.95	\$47.95

See page 84 for Jameco's new addition of surface mount proto boards.



General Purpose Prototyping Boards

Select the prototype board that fits your needs from our comprehensive product listing. Prototyping boards with punched holes are convenient, economical tools for assembling circuit components and trying cost-effective alternatives to custom designs.

- 0.062" board thickness
- 0.1" hole spacing
- 0.08" pad size
- Plated through pads are double-sided
- PCB material epoxy glass

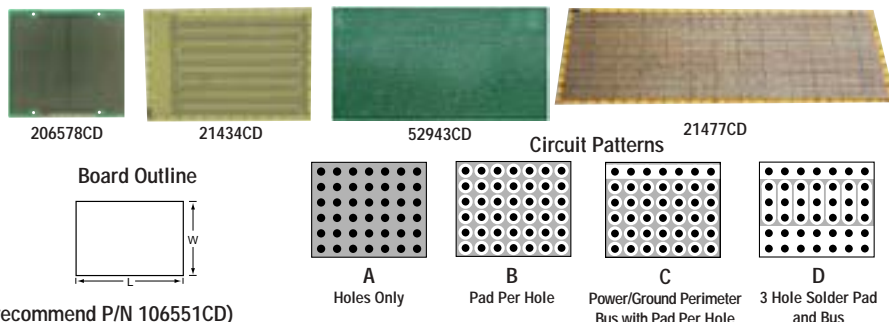

See pg 118 for PCB mounting enclosures and hardware (recommend P/N 106551CD)

Part Number	Product Number	Size (W" x L")	Fits Enclosure(s) (see page 118)	Circuit Pattern	Hole Pads	# Holes x Dia. †	Power/Ground Busses	Connector I/O or Edge	# Mounting Holes x Dia.	Weight (lbs.)	Pricing			
											1	10	50	100
105099CD	2855PCB	1.60 x 2.70	18921CD	B	Single-sided	288 x .035"	None	None	2 x .115"	.02	\$4.95	\$4.49	\$3.95	\$3.59
105101CD	5002PCB	1.50 x 3.50	11957CD	C	Single-sided	365 x .038"	4	None	2 x .140"	.02	6.95	6.25	5.59	4.95
105128CD	2853PCB	2.00 x 4.40	18913CD, 11965CD	C	Single-sided	669 x .038"	4	None	4 x .140"	.03	7.95	6.95	6.25	5.59
105110CD	2300PCB	2.40 x 3.40	11869CD, 11914CD	C	Single-sided	637 x .038"	4	None	2 x .140"	.03	7.95	6.95	6.25	5.59
28177CD	PCB1	2.42 x 4.10	18913CD	C	Plated through	674 x .040"	None	None	4 x .120"	.04	5.95	5.35	4.79	4.29
105152CD	2851PCB	3.10 x 5.50	18892CD	C	Single-sided	1450 x .035"	7	None	4 x .140"	.07	9.95	8.95	7.95	6.95
105136CD	2320PCB	3.30 x 4.50	11885CD	C	Single-sided	1266 x .035"	4	None	4 x .140"	.06	9.95	8.95	7.95	6.95
105161CD	2852PCB	3.60 x 7.00	18905CD, 11973CD	B	Single-sided	2225 x .035"	4	None	4 x .140"	.10	14.95	13.45	11.95	10.95
206586CD	2746APCB	4.30 x 6.80	209349CD	C	Single-sided	2550 x .042"	5	None	4 x .140"	.07	9.99	8.99	8.19	7.39
21434CD	JE401(8001)	4.50 x 6.50	18868CD	B/D	Single-sided	2360 x .042"	2	None	None	.12	20.95	18.95	16.95	15.49
21451CD	JE405(8003)	4.50 x 6.50	18868CD	C	Single-sided	2360 x .042"	1	None	None	.12	19.95	17.95	15.95	13.95
43140CD	64P44XXXP*	4.50 x 6.50	18868CD	A	Drilled only	2860 x .042"	None	None	None	.09	6.95	6.59	6.25	5.95
52943CD	84P44WE	4.50 x 8.50	18876CD	A	Drilled only	3740 x .042"	None	None	None	.15	9.19	8.99	8.89	8.79
37604CD	169P44WE	4.50 x 17.0	N/A	A	Drilled only	7524 x .042"	None	None	None	.31	16.95	16.25	15.49	14.69
37612CD	169P44XXXP*	4.50 x 17.0	N/A	A	Drilled only	7524 x .042"	None	None	None	.25	12.95	12.29	11.69	10.95
206578CD	2743APCB	4.60 x 4.30	208910CD	C	Single-sided	1684 x .042"	5	None	4 x .140"	.07	6.99	6.29	5.69	5.19
105179CD	2505PCB	5.00 x 6.50	11893CD, 18868CD, 11949CD	C	Single-sided	2829 x .035"	7	None	8 x .120"	.13	14.95	13.49	11.95	10.95
28193CD	PCB3	5.00 x 8.00	18876CD	C	Plated through	3705 x .042"	4	Mounting area-I/O	4 x .120"	.17	23.95	20.95	19.95	17.95
21477CD	JE407(8006)	5.00 x 13.25	N/A	B	Plated through	6063 x .038"	None	None	8 x .120"	.28	39.95	35.29	33.49	31.85
206594CD	2747APCB	5.50 x 8.00	209357CD	C	Single-sided	3906 x .042"	5	None	4 x .140"	1.0	13.99	12.59	11.29	10.19
105187CD	2507PCB	6.10 x 8.80	18876CD	C	Single-sided	4771 x .035"	7	None	8 x .140"	.21	29.95	26.95	23.95	21.95
37621CD	169P84WE	8.50 x 17.0	N/A	A	Drilled only	14448 x .042"	None	None	None	.53	23.95	22.75	21.59	20.49

* PCB material: phenolic

† All 0.042" diameter hole boards use terminals T44, T49, and T421 (see below)

Wire Wrap and Push-In Terminals

For .042" Diameter Holes

Specifications:

- Material: copper alloy • Prebagged 100 pcs.
- 34147CD: Push-In Micro-Klip Terminals
- Overall length: .36" • Post size: .032" x .045"
- 34155CD: Miniwrap Wiring Terminals • Shoulder: .045"
- Two-prong with square tail for wire wrapping
- Overall length: .69" • Post size: .025" Sq.
- 34163CD: Klipwrap Wiring Terminals • Shoulder: .045"
- Three-prong with square tail for wire wrapping
- Overall length: .83" • Post size: .025" Sq.

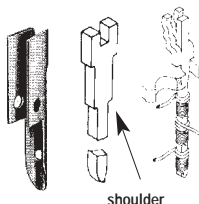

Part Number	Mfr. Cross Ref. No.	Height Above .062" Board	Length Below .062" Board	100 pc. units	
				1	10
34147CD	T421	.200	.097	\$7.69	\$6.95
34155CD	T44	.065	.530	8.95	8.09
34163CD	T49	.200	.530	11.59	10.75

Copper-Plated Blank Circuit Boards

Ideal for hobbyists and students doing prototypes of circuits. Copper plating on board for either single-sided or double-sided boards.

- 1.6mm thickness

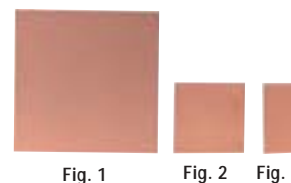

Single Side							
Part No.	Product No.	Size (L" x W")	Fig.	Wt. (lbs.)	1	10	50
169279CD	PCBS3X6	3.0 x 6.0	3	0.1	\$3.49	\$3.15	\$2.85
169287CD	PCBS6X6	6.0 x 6.0	2	0.2	4.95	4.49	3.95
169295CD	PCBS12X12	12.0 x 12.0	1	0.5	13.95	12.56	11.30
Double Side							
169308CD	PCBD3X6	3.0 x 6.0	3	0.1	\$4.95	\$4.45	\$3.95
169316CD	PCBD6X6	6.0 x 6.0	2	0.2	7.95	7.15	6.45
169324CD	PCBD12X12	12.0 x 12.0	1	0.7	17.95	15.95	14.49

ISA Printed Circuit Prototyping Boards

Printed circuit prototyping boards for virtually any application – including those requiring high component densities and solder or wire wrap connections. All boards are manufactured to precise standards and specifications. All bus and circuit patterns are solder-coated for user convenience.

- Edge contacts: gold

Part Number	Product Number	Description	Size (Inches) W x L	Terminals (above)			I/O Connector (not included)	Circuit Pattern	Hole Pads	# Holes x Dia.	Power/Ground Bus	# Mounting Holes x Dia.	Weight (lbs.)	Pricing		
				T44	T49	T421								1	10	25
21531CD	JE417	PC/XT 8-bit	4.2 x 6.50	yes	yes	yes	D-sub 9, 15, 25 & 37	C	Plated through	2126 x .042"	2	8 x .120"	.12	\$22.95	\$19.55	\$14.65
28206CD	PCB4	PC/XT/AT 16-bit	4.25 x 13.13	yes	yes	yes	D-sub 9, 15 & 25	C	Plated through	4890 x .042"	2	4 x .120"	.23	26.95	24.25	21.85

• See page 118 for circuit board mounting hardware • See page 120 for round and hex aluminum spacers & standoffs

microEngineering Labs

"PICProto" Prototyping Boards

- High quality blank prototyping boards for PICmicro microcontrollers
- Holds microcontroller, 5V regulator, oscillator, capacitors and DB9-25 connector
- Double-sided board with plated-through holes
- Large prototyping area
- Solder mask on both sides makes soldering easy
- Silkscreen legend

Includes: Documentation sheet with schematic, suggested parts and placement

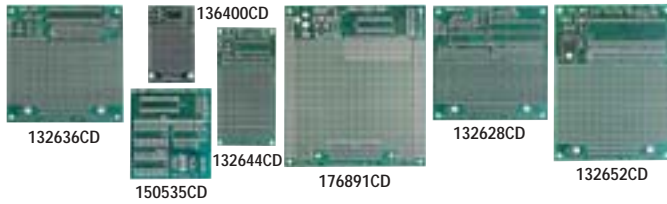

PICProto 18, 18L: For all 18-pin PICs including PIC16C52, 54, 56, 58, 55A, 55B, 61, 620, 621, 622, 71, 710, 711, 712, 715, 716, 84, 16CE623, 624, 625, 16F627, 628, 83, and 84

Part No.	Description	Size (L" x W")	1	10
132644CD	PICProto 18	3.0 x 1.5	\$9.95	\$8.95
176891CD	PICProto 18L	3.6 x 4.1	19.95	17.95

PICProto 3: For the 28-pin PIC16C62, 63, 642, 66, 72, 76, 773, 16F73, 76, 870, 872, 873, 876, 18C242, and 252

132636CD	PICProto 3	3.0 x 3.0	\$14.95	\$13.49
----------	------------	-----------	---------	---------

PICProto 64: For the 40-pin PIC16C64, 65, 662, 67, 74, 77, 774, 16F74, 77, 871, 874, 18C422, and 452

132652CD	PICProto 64	4.0 x 3.0	\$16.95	\$14.95
----------	-------------	-----------	---------	---------

PICProto 8: For all 8-pin PIC12Cxxx and 12Cxxxx

136400CD	PICProto 8	2.0 x 1.2	\$8.95	\$7.95
----------	------------	-----------	--------	--------

PICProto Dual: For 18-pin PIC16C52, 54, 56, 58, 55A, 55B, 61, 620, 621, 622, 71, 710, 711, 712, 715, 716, 84, 16CE623, 624, 625, 16F627, 628, 83, & 84, as well as 28-pin PIC16C55, & 57. Accepts standard 0.6" 28-pin device or 0.3" skinny DIP

132628CD	PICProto Dual 18/28	3.0 x 3.0	\$14.95	\$13.49
----------	---------------------	-----------	---------	---------

PICProto S1: For working with circuits in "Easy PIC'n" and PIC'n Up the Pace" (pg 0). Holds 18-pin PICmicro, oscillator, 5-volt power supply, DIP switches, & socket to solderless breadboard

150535CD	PICProto S1	2.1 x 1.9	\$14.95	\$13.49
----------	-------------	-----------	---------	---------

microEngineering Labs

EPIC Plus PICmicro Programmer

The EPIC Plus Programmer quickly and easily programs the PIC12Cxxx, 12CExxx, 16C505, 16C55x, 6xx, 7xx, 84, 9xx, 16CE62x, 16F62X, 7x, 8x, 87x, 14C000, 17C7xx, 18Cxxx microcontrollers from Microchip. The basic programmer includes an 18-pin socket for programming 8, 14 and 18-pin PICmicro MCUs. Devices available separately on page 70.

- Simple installation with parallel port (printer) interface
- Interactive software for Windows and DOS
- Command line operation for automated, non-interactive programming
- PICmicro Assembler software included

Requires: Two 9V batteries or AC adapter (below)

Part No.	Description	1	10
132679CD	EPIC Plus PICmicro programmer	\$59.95	\$53.95
136397CD	8/18/20-pin ZIF adapter	34.95	31.95
132610CD	40/28-pin ZIF adapter	34.95	31.95
162317CD	AC wall adapter (16VDC/500mA, details on page 57)	7.95	6.95
67256CD	6' DB25 cable (details on page 184)	6.45	5.79



microEngineering Labs

PICBasic and PICBasic Pro Compiler

PICBasic converts your BASIC programs into files that can be programmed directly into a PICmicro MCU.

- Compatible with most PICmicro MCU programmers including EPIC plus
- Use in DOS or Windows (includes Windows editor/DE software)
- I2C instructions to access external serial EEPROMs
- In-line assembler and call support

132661CD: PICBasic Compiler

- Expanded BASIC Stamp I compatible instruction set
- PEEK and POKE instructions to access any register from BASIC
- Serial speeds to 9600 baud
- Supports PIC12C67x, PIC14Cxxx, PIC16C55x, 66x, 7xx, 84, 92x, and PIC16CF8xx microcontrollers
- May use up to 2k of code space

150543CD: PICBasic Pro Compiler

- Direct and library routine access to any pin or register
- Automation page boundary handling past 2k
- Real If...Then...Else...Endif
- Interrupts in BASIC and assembler
- Built-in LCD support
- Supports 12C5xx, 12C67x, 12CE67x, 14C000, 16C5x, 16C55x, 6xx, 7xx, 84, 92x, 16CE62x, 16F62x, 7x, 8x, 87x, 17Cxxx, and 18Cxxx microcontrollers
- Bit, byte, word arrays
- Hierarchical expression handling
- BASIC Stamp I and II library
- MPLAB/MPASM/ICE compatibility

Part No.	Description	1	10
132661CD	PICBasic compiler	\$99.95	\$89.95
150543CD	PICBasic Pro compiler	249.95	224.95



132661CD

microEngineering Labs

LAB-X1 Experimenter's Module Board

The LAB-X1 is a pre-assembled experimenter's platform. It provides an assembled testbed containing most of the circuitry commonly used with PICmicro microcontrollers (MCUs). Many different projects may be created using the LAB-X1, including calculator, voltmeter, LCD backpack, tone dialer, and RC servo controller.

- 40-pin ZIF socket for PICmicro MCU (not included, PIC16F877-20/P recommended)
- Jumper selectable oscillator from 4MHz to 20MHz
- Reset button
- 16 switch keypad
- 3 potentiometers
- LED bargraph
- 2 lines x 20 characters LCD module
- Speaker
- 2 RC servo connectors
- RS232 interface
- Socket for RS485 interface (device not included)
- Socket for I2C & SPI serial EEPROM (device not included)
- One-year warranty
- Socket for Microwire serial EEPROM (device not included)
- Socket for real time clock/serial analog to digital converter (devices not included)
- EPIC in-circuit programming connector
- Prototyping area for additional circuit
- Wiring for microchip in-circuit debug connector
- Size: 5.5" x 5.6"

Requires: AC adapter (below)

Part No.	Description	1	10
169113CD	LAB-X1 Experimenter Board	\$199.95	\$189.95
176903CD	LAB-X1 Experimenter Board Kit	149.95	139.95
198168CD	LAB-X2 for 28 and 40-pin MCUs	64.95	58.49
198176CD	LAB-X3 for 18-pin MCUs	119.95	107.95
176882CD	PIC16F877-20/P microcontroller (pg 70)	9.49	8.49
127976CD	AC adapter (details on page 55)	4.75	4.25



SALE

See page 215 for
PIC Books and
for Circuit Board Book.



Don't worry about backorders.
Over 99% of our products are in stock!

We'll Send It Today!

Just place your order by 6PM EST
for same business day shipment

Wire Jumper Kit (350 pcs.)

- 25 each of lengths 0.1" through 5.0" (14 sizes)
- 350 assorted lengths in 13 colors
- Pre-stripped/preformed 22 AWG solid wire jumpers



19289CD

19289CD: 350-piece wire jumper kit

• Handy, durable, clear plastic case

19289CD: 350-piece refill for 19289CD

• Case not included

SALE

Part No.	Description	1	10	50	100
19289CD	Wire jumper kit	\$15.95	\$14.39	\$12.95	\$11.65
20079CD	Refill for 19289CD	9.99	8.99	7.99	7.25

Reinforced Jumper Wires

- 24 AWG-300 volts
- Reinforced pin ends for durability
- 10 pack assortment: 2 each yellow, white, red, black & blue



126341CD

Part Number	Mfr. Cross Ref. No.	Length (mm / inch)	1	10	100
126359CD	JW50	50 / 1.97 ...	\$3.95	\$3.49	\$2.95
126341CD	JW100	100 / 3.94	4.95	4.49	4.05
126324CD	JW200	200 / 7.87	5.19	4.69	4.25

Resistance and Capacitance Decade Substitution Boxes

Wide-range decade substitution boxes for product design or calibration checks.

- Light durable construction
- Case may be grounded separately
- Three binding posts permit isolated substitutions
- Size: 4.7"W x 5.7"H x 1.4"D
- Weight: 0.7 lbs.



EXTECH INSTRUMENTS

211668CD

211668CD:

- 1% resistance substitution from 1Ω to 11,111,110MΩ
- 7 decade ranges of resistance
- Values can be changed in 1Ω increments



211676CD

211676CD:

- 5% capacitance substitution from 100pF to 11,111μF
- 5 decade ranges of capacitance

Part No.	Description	1	10
211668CD	Resistance	\$98.95	\$93.95
211676CD	Capacitance.....	128.95	122.45

AC/DC Power Supply

Ideal for Breadboards on page 112



International 120/220VAC Switchable

Output Specifications:
 +5VDC @ 1A;
 -5V @ 300mA fixed;
 0 to +15VDC @ 500mA variable,
 0 to -15VDC @ 300mA variable;
 12-6-0-6-12 tapped VAC,
 300mA fixed

With built-in short-proof regulated power supplies.

- Input power: 120/220VAC @ 50-60Hz (switchable)
- Indicator lamps and power fuses
- Just plug-in and start to use • Compact & lightweight
- For both digital and analog circuits
- Compatible with test leads P/N 77841CD, pg 152
- Size: 7.4"W x 5.5"D x 2.6"H • Color: beige
- Weight: 5.5 lbs. • One-year warranty

Part No.	Description	1	10	25
77681CD	Power supply ...	\$119.95	\$109.95	\$99.95

Digital/Analog Design Labs

- Two 7-Segment Displays (digit height: 0.3")
- One-year warranty

Solderless Breadboard

- Interconnected nickel-plated tie points, fitting all DIP sizes and all components with AWG #22-30 (0.3-0.8mm) solid leads

DC Power Supplies

- DC supplies equipped with short circuit protection
- Variable DC power:
0 to +15V & 0 to -15V @ 0.5A

Function Generator (5 ranges)

- Frequency range: 1Hz-10Hz, 10Hz-100Hz, 100Hz-1kHz, 1kHz-10kHz, 10kHz-100kHz
- Sine wave output: 0-8 Vp-p variable • Triangle wave output: 6Vp-p fixed • Square wave output: ±5V fixed



75838CD

Our most popular digital lab!

International 115/220VAC Switchable



201890CD

Part No.	Tie Points	Fixed Power Supply	Pulse Generator	Frequency Counter	Multimeter	Includes
75838CD	1580	+5VDC @ 1.0A	No	No	DCV (Digital)	Power cord, manual
201890CD	2960	+5VDC @ 0.5A	Yes (1Hz to 1MHz switchable)	Yes	ACV, DCV, DCmA, resistance (analog)	Power cord, enclosed case, test lead, jumper wire kit, DB25 serial adapter, manual

Part No.	Description	Size (W" x D" x H")	Weight (lbs.)	1	10	25
75838CD	Digital lab	10.6 x 13.3 x 5.0	8.1	\$276.95	\$249.95	\$226.95
201890CD	Digital/analog lab	13.9 x 12.8 x 4.9 (back panel)	11.8	429.95	389.95	349.95

Digital-Analog Design Lab

Solderless Breadboard

- 2712 interconnected nickel-plated tie points, fitting all DIP sizes and all components with AWG #22-30 (0.3-0.8mm) solid leads

DC Power Supplies

- Variable DC output: 0 to +15V & 0 to -15V @ 500mA
- Fixed DC output: +5VDC, 1A; -5VDC, 300mA
- Input power: 120/220VAC @ 50-60Hz (switchable)

- Function Generator • Frequency ranges: 1Hz-10Hz, 10Hz-100Hz, 100Hz-1kHz, 1kHz-10kHz, 10kHz-100kHz
- Sine wave output: 0-8 Vpp variable • Triangle wave output: 0-6 Vpp variable • Square wave output: 0-8 Vpp variable

Other features:

- 2 variable resistors: VR1=1kΩ, VR2=100kΩ • 8 data switches • 2.5" dia. 8Ω, 25W speaker
- 2 pulse switches (2 sets of outputs: A, A, B, B) • 2 banana sockets, 2 BNC jacks • One-year warranty
- Two 7-segment LED displays (digit height: 0.3") • 8 red LEDs with separate input terminals

Includes: Power cord and manual

Part No.	Description	Size (W" x D" x H")	Weight (lbs.)	1	10	25
136266CD	Digital-analog lab	12.8 x 9.8 x 3.7	8.5	\$379.95	\$341.99	\$307.79



International 120/220VAC Switchable

Powered Project Board

- Solderless breadboard with 2420 tie points
- DC power supplies: +5V @ 1A; variable power 0 to +15VDC and 0 to -15VDC @ 500mA
- Back panel has ground terminal
- Outputs are short-circuit protected
- Edge plate for non-DIP size components
- Input power: 120/220VAC @ 50-60Hz (switchable)
- Replacement fuse: P/N 103907CD, pg 92
- Power switch with light
- Breadboard size: 7.4"L x 6.8"W
- Enclosure size: 9.8"L x 8.0"W x 2.6"H
- Weight: 6.8 lbs. • One-year warranty



International 120/220VAC Switchable

CE

Includes: Power cord

Part No.	Description	1	10	25
136258CD	Powered breadboard	\$99.95	\$89.95	\$87.95

See page 84 for surface mount protoboards that plug into standard solderless breadboards.

512k E(E)PROM / Flash Programmer USB Interface

Compact, portable, and lightweight stand-alone E(E)PROM flash programmer. Also interfaces with your PC through the USB port.



NEW

- Programs EPROMs 27C/LV (64 - 080); EEPROMs 28C(256-040); Flash EPROMs 29C(256-040) / 29EE/LE (512-020)/28F(256-020A)/29F(010-040) and more
- 2 sockets for master/slave operation
- Stand-alone mode uses two 9V batteries
- IC parameters are adjustable such as programming algorithm, Vpp voltage, and pulse width
- Supports file formats binary and machine code, INTEL HEX, Motorola HEX
- Supports Windows® 95/98/NT/2000/ME/XP
- Size: 6.3"L x 4.3"W x 1.8"H

FUNCTIONS	
Stand Alone Mode:	- Functions - Blank check
- Type - Program - Verify	- PC-Based Mode:
- Type - Read - Blank	- Check - Program
- Verify - Erase - Disk	- Help - Process - Parameter

Includes: USB cable, 12VDC @ 500mA power adapter; and CD-ROM

Part No.	Description	1	5
220636CD	Leaper-3C	\$299.95	\$284.95



High-Speed Universal Device Programmer/Tester

Parallel Port Interface

- 48-pin universal ZIF socket accepts any number of pins
- Programs Flash memory, PROM, EPROM, EEPROM, Serial (E)EPROM, Bipolar PROM, PAL, PALCE, GAL, NVRAM, PEEL, CPLD, SPLD, CPLD, PIC & Microcontrollers
- Tests TTL, CMOS, DRAM and Static RAM ICs
- 5000+ device types supported
- On-board FPGA for speed; 4 times faster than offshore brands
- Supports real 5.0V; 3.3V, 2.7V, 2.0V & 1.8V devices
- Hardware diagnostic program examines all 48-pin drivers
- Supports POF and JEDEC formats
- Detects pin locations for poor or damaged contacts
- Current limiting protects hardware circuits from improperly inserted or defective chips
- High-speed device function tests and user creatable test library
- Read, blank check, program, verify, checksum, data compare, security, auto (erase, blank check, program, verify), and option bit program function
- Built-in editor for both buffer date and test vectors
- CE/CUL/CSA quality certified



207765CD



207757CD



207749CD



SALE

Includes: Parallel cable, installation diskette, power cord and manual

System Requirements: IBM PC, XT, AT, 386, 486, Pentium®, hard drive, 512k RAM, Windows® 95/98/2000/NT, and parallel port

Part No.	Description	1	5
207765CD	TOPMAX	\$874.95 \$875.95	\$832.95
207757CD	32-pin DIP adapter	289.95	274.95
207749CD	32-pin PLCC adapter	499.95	474.95

Versatile, Production Quality Universal Programmers

Parallel Port Interface

- 207773CD: 48-pin ZIF socket
- 207781CD: One 48-pin and three 32-pin ZIF sockets
- 3000+ device types supported
- Supports EPROM, flash, microcontroller, Serial (E)EPROM, EPLD, PALCE, GAL, PEEL
- Auto search device select function
- Fast programming speed with IC vendor approved algorithms
- Built-in editor for both buffer date and test vectors
- Supports JEDEC, Intel Hex, Motorola S Records, Binary and ASCII file formats with File LOAD/SAVE command
- Built-in macro commands for programming



207781CD



Includes: 01/02/03 personality modules, parallel cable, wall adapter, diskette and manual

System requirements: IBM PC, XT, AT, 386, 486, Pentium®, hard disk, 512k RAM, standard parallel port, MS-DOS 2.11 or higher, Windows® 95/98

Part No.	Description	1	5
207773CD	MEGAMAX programmer ..	\$375.95	\$355.95
207781CD	MEGAMAX4G programmer	449.95	426.95



Fast, Low-Cost Universal Device Programmer

Parallel Port Interface

- 40-pin ZIF socket
- Programs (E)EPROM, PROM, Serial PROM, PALCE, GAL, flash memory, microcontrollers, ATF
- 2000+ device types supported
- Menu driven software
- On-board FPGA for speed; 4 times faster than offshore brands
- Auto search device select function supports (E)EPROM & microcontrollers
- Device insertion test identifies improperly inserted device before programming
- Auto programming for production programming
- Read, blank check, program, verify, checksum, data compare, security, auto function



Includes: Parallel cable, wall adapter, diskette & manual
System Requirements: IBM PC, XT, AT, 386, 486, Pentium® or compatibles, DOS 2.11 or greater, Windows® 95/98/2000/NT/XP; hard disk, 512k RAM and standard parallel port

Part No.	Description	1	5
207731CD	CHIPMAX	\$349.95	\$332.95

1MB EPROM Programmer

Serial Port Interface

- ZIF socket
- Motorola s1f, s2f and s3f can convert to binary or ASCII prior to download
- Baud rate configurable
- Data bits: 8
- Start/Stop bits: 1
- Parity: none, even, odd, default none
- Flow control: none, RTS/CTS, XON/XOFF, Default RTS/CTS
- Programs EPROMs up to 512kbits and the Intel 27C011 (1Mbits); 2716-27512; 2804-8256; also 27CXXX and 28CXXX series
- Selectable VPP from 5V-25V
- Maximum pins: 28 • One-year warranty



SALE

Part No.	Description	1	10
82384CD	1Mbits EPROM prog.	\$179.95	\$161.99

HI-LO SYSTEMS EPROM Eraser

- Erases all UV erasable EPROMs
- Holds a total of 16 EPROMs 32-pin
- Upper and lower erasing chambers
- Conductive foam liner eliminates static build-up
- One-year warranty
- Size: 8.5"L x 2.8"W x 2.8"H • Weight: 1.6 lbs.



Includes: AC adapter – 9VDC @ 600mA and a timer which turns eraser off at the end of the selected time period – 10 to 60 minutes

Part No.	Description	1	10
121267CD	EPROM eraser	\$149.95	\$134.95

Opening an account is easy!!

Corporate Customers

Call 1-800-831-4242 for details today!

16kB-256MB Universal IC Programmer/Tester

Parallel Port Interface

HI-LO SYSTEMS

Supports over 7,000 devices including EPROM, EEPROM, Serial PROM, FLASH, PLD/ CPLD/ FPGA, MPU/MCU and much more. Most devices in various package types can be programmed with the on-board 40-pin ZIF socket or through an appropriate adapter/ converter. Modular pin drivers program at high speed and provide high reliability and expansion capability.

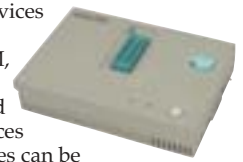

- Functions of load file, read master, program, verify, auto, ID check, checksum, blank check, erase, secure, protect/unprotect, edit, file transfer, function configuration and self test

Includes: External power supply, DB25 M/F cable, manual and software drivers on CD-ROM

System Requirements: Intel Pentium, 32MB of RAM, parallel port, Windows® 95/98/NT/2000/XP, 5MB free hard disk space, CD-ROM drive

206922CD: UV opaque EPROM window labels (168 per pack)



Part No.	Description	1	10
216039CD	ALL-11C2 programmer	\$899.95	\$799.95
206922CD	1.1" x .046" window label	6.95	5.95

512k E(E)PROM Programmer

- Programs EPROMs up to 25V, Flash EPROMs (5V and 12V) EEPROMs, and SRAMs
- 2 sockets for master/ slave operation
- Stand alone mode uses two 9V batteries (P/N 151095CD, pg 202) or included 12VDC @ 0.5A adapter
- One-year warranty
- Size: 6.4"L x 4.3"W x 2.2"H



FUNCTIONS	
Stand alone mode	
- Functions Set - Blank check	
- IC Type select - Program	
- Verify and check sum	
Remote control mode	
- Type - Read - Program	
- Verify - Disk - Help	
- Process - Parameter	

Includes: Adapter, cable & CD-ROM

Part No.	Description	1	10
130155CD	EPROM programmer	\$289.95	\$259.95

EPROM Erasers and Accessories

66042CD:

- Erases 1 chip in 7 minutes
- Conductive foam liner eliminates static build-up
- UV intensity: 6.5mW/cm²
- Size: 6.8"L x 1.5"W x 2.3"H
- Weight: 0.8 lbs. • One-year warranty



66042CD

Requires: Four AA batteries (not included), recommend P/N 32627CD (below)

15712CD:

- Erases 1 chip in 15 minutes or 8 chips in 21 minutes
- UV intensity: 6.8mW/cm²
- Maintains constant exposure distance of 1"
- Conductive foam liner eliminates static build-up
- Built-in safety lock to prevent UV exposure
- Complete with holding tray for 8 chips
- Size: 9.0"L x 3.7"W x 2.6"H • Weight: 2.3 lbs.



15712CD

Part No.	Description	1	10	25
66042CD	Portable eraser	\$64.95	\$58.95	\$52.95
15712CD	8-chip eraser	109.95	104.95	99.95
34382CD	Lamp for 15712	34.95	34.95	34.95
13864CD	Foam (12"x24"x0.25")	7.95	6.95	6.15
32627CD	'AA' Ni-Cad battery	1.95	1.75	1.49

Universal EPROM/Flash Programmer With USB Interface

- Supports low voltage components up to 2.5V; user selectable verify Vcc with one or two-pass verify voltage
- High speed: 30 sec. to process 16Mbits memory
- Simple operating software: the programming procedure has only a few automatic process functions
- Auto detect device pin insertion and contact check
- Select device brand & number by prompt & convenient cross search, FLASH memory auto detection
- Supports EPROMs, EEPROMs, FLASH EPROMs, Serial E/EPROMs, NV RAMs, Microcontrollers, DSPs & PLDs
- Supports file formats JEDEC, binary, Intel 80/86 HEX, Motorola HEX, Tektronic HEX



Includes: USB cable, 12V@1.5A power adapter and CD-ROM software

System requirements: Pentium® II or higher, 32MB RAM minimum, 30MB hard disk space, Windows® 98/ME/2000 operating system

Part No.	Description	1	10
225939CD	Leaper 48.....	\$599.95	\$569.95

MCS-51 Programmer With USB Interface

- Programs 8-bit MCS-51 serial ICs via USB cable on Windows® 9x/2000/XP
- High-speed, high performance programming: ATMEL AT89S52 takes 4 seconds to erase, blank check, program, and verify
- Type, read, load, edit, checksum, erase, blank check, program, verify, protect functions
- Supports file formats binary and machine code, Intel HEX, Motorola HEX, Tektronix
- Supports ATMEL; Hyundai; Intel 87C; ISSI, Philips, SST, TEMIC, and Winbond ICs



Includes: USB cable, 12V @ 500mA power adapter, CD-ROM software and manual

System requirements: Pentium III 500 or higher, Windows® 98/2000/XP, 20MB hard disk space, USB port

Part No.	Product No.	1	10
225921CD	Leaper 5E	\$249.95	\$236.95

Flash Writer/Programmer With USB Interface

- Programs 8-bit FLASH serial ICs via USB cable on Windows® 9x/2000/XP
- High speed: Only 22 seconds to blank check, program, and verify MXIC MX29F040
- File formats supported: binary and machine code, Intel HEX, Motorola HEX, Tektronix
- Type, read, load, edit, checksum, erase, blank check, program, verify, protect functions
- Supports Flash EPROM, EPROM and EEPROM



Includes: USB cable, 12V @ 500mA adapter, CD-ROM software and manual

Part No.	Description	1	10
225947CD	Leaper 3D	\$219.95	\$208.95

Single-Sided Copper-Clad Circuit Boards

One 5" x 6" and one 3" x 4.5" (copper clad one sided) 1/16" glass epoxy circuit board.



Part No.	Prod. No.	Description	1	10	25
16707CD	ER11	Circ. boards	\$5.95	\$5.35	\$4.79

Pre-Sensitized Circuit Boards & Developer

- Pre-coated circuit board
- Size: 3.0"L x 4.0"W x 1/16"T



Includes: Instructions

Part No.	Description	1	10	25
156751CD	Single sided	\$4.95	\$4.49	\$3.95
156742CD	Double sided	6.49	5.85	5.25
156734CD	4 oz. Pos. developer*	6.95	5.95	4.95

* Shipped via UPS ground to continental U.S. only

Workshop Chemicals

- Safe on plastics
- EPA SNAP approved, no CFCs or HCFCs



• Shipped via UPS ground to continental U.S. only.



Envi-Ro-Tech™ Duster

Part No.	Description	Wt. (lbs.)	1	12
139900CD	10 oz. aerosol w/ trigger	0.8 ...	\$6.95	\$6.25

Envi-Ro-Tech™ Freezer

Rapidly evaporating liquid that can chill to -62°F.

Part No.	Description	Wt. (lbs.)	1	12
139934CD	10 oz. aerosol can	0.8 ...	\$8.95	\$7.99

ECOLINE Cleaner Degreaser

- Rapid evaporation • 10 oz. aerosol can

Part No.	Description	Wt. (lbs.)	1	12
118050CD	Cleaner degreaser	0.8 ...	\$9.95	\$8.95

ECOLINE Flux Remover

- Dissolves type R, RMA, RA, SA and most no-clean fluxes • 10 oz. aerosol can

Part No.	Description	Wt. (lbs.)	1	12
118041CD	Flux remover	0.8 ...	\$9.95	\$8.95

ECOLINE Contact Cleaner

- Ideal for switches, relays, contact pads and other places of electrical connections • 10 oz. aerosol can
- Solvent will not damage switch housings

Part No.	Description	Wt. (lbs.)	1	12
118033CD	Contact cleaner	0.9 ...	\$8.95	\$7.95

VORTEX 360 Duster

- Vortex 360° invertible valve • 10 oz. aerosol

Part No.	Description	Wt. (lbs.)	1	12
195240CD	Dusting gas	0.8 ...	\$8.45	\$7.65

Chemical Products



CircuitWriter™

Part No.	Description	Fl. (oz.)	1	12
195160CD	Conductive silver based ink	0.2	\$13.89	\$12.55

Conductive Carbon Coating

- Conductive carbon coating for repairing button contacts and membranes • EMI shielding coating

Part No.	Description	1	12
195186CD	CaiKote™ 44 carbon based	\$19.95	\$17.99

Photo Etch™ Printed Circuit Kit

Generate your own 1:1 artwork. Then use the patented Fast Neg film process to make a photo negative and sensitize and expose a blank copper board. Finish by developing and etching. No camera or darkroom is required.



Part No.	Product No.	Wt. (lbs.)	1	10
16731CD	12-750*	4.6	\$39.95	\$36.95

* Shipped via UPS ground to continental U.S. only

Direct Etch PCB "Starter" Set

Includes: 4 blank circuit boards, dry concentrated ferric chloride etchant, instructions, 8 sheets of direct etch donuts, DIP, patterns, lines and 1/32" & 1/16" etch resist tape.



Part No.	Prod. No.	Description	Wt. (lbs.)	1	10
70412CD	ER1	PCB kit	0.7 ...	\$11.95	\$10.95

Dry Concentrated Etchant

- Makes one pint of etch solution

Part No.	Prod. No.	Description	1	10	25
70201CD	ER3	Dry etchant	\$3.95	\$3.49	\$2.95

Accessories



Part No.	Prod. No.	Description	Wt. (lbs.)	1	10
16758CD	ER8*	Negative-acting resist developer 16 oz.	1.2	\$5.95	\$5.39
16723CD	ER18	TINNIT™ 1 pint	0.2	6.95	5.95
70261CD	ER71*	Negative-acting photo resist liquid 4 oz.	0.5	8.95	7.95
70480CD	ER181	TINNIT™, 1/2 gallon size (bulk pack)	0.6	15.95	14.49

* Shipped via UPS ground to continental U.S. only

Acid Brush

- Used for application of reactive solvents

Part No.	Description	1	10	100	1000
15332CD	Metal handle, 6"	\$59	\$49	\$36	\$25

Prototype Builder Boards, Enclosures and Hardware

Call for additional OEM pricing.

The prototype builder boards on this page are specifically designed to fit into our ABS speedy boxes, die cast aluminum enclosures, aluminum boxes, metal cabinets and heavy-duty instrument cases shown in each grouping. These pre-cut boards have 2 or 4 mounting holes compatible with the PC board mounting hardware listed at the bottom, right (P/N 106551CD).

Board description: laminated glass epoxy 1/16" thick fire retardant per FR-4 specs. Copper-clad and solder mask one side. Drilled holes: .035" diameter on .080" square pad. Pads spaced on .10" x .10" grid.

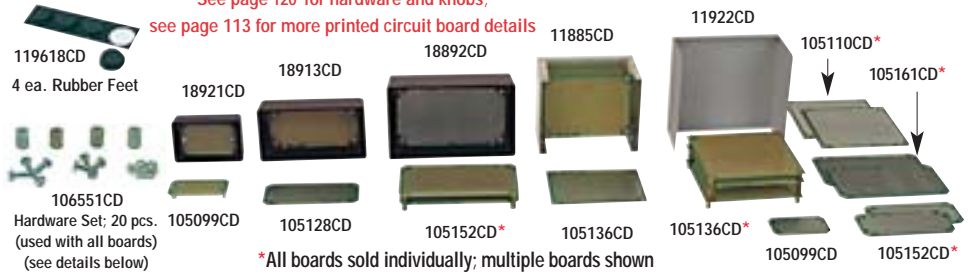

See page 120 for hardware and knobs;
see page 113 for more printed circuit board details

ABS Speedy Enclosures

Will not crack or split when drilled or punched. PCB mounting slots on all four sides. Lid has a lip for precision fit (adds 0.4" height). Complete with four screws and lid. All sizes below are for interior dimensions. • Color: black • ABS plastic



Part No.	Product No.	Size (L x W x D)	Wt. (lbs.)	1	10	50	100
18921CD	H2855	3.1" x 2.0" x 0.9"	0.1	\$2.99	\$2.69	\$2.45	\$2.19
18913CD	H2853	4.9" x 2.5" x 1.5"	0.2	3.49	3.15	2.85	2.55
18892CD	H2851	6.0" x 3.5" x 1.9"	0.4	4.49	4.05	3.65	3.29
18905CD	H2852	7.5" x 4.3" x 2.3"	0.5	6.49	5.85	5.29	4.75

Printed Circuit Boards for Above Enclosures

• Power/ground, perimeter bus with pad per hole (*except P/N 105099CD)

• Plated one side holes



Part No.	Product No.	Size (L x W)	No. of Holes	1	10	50	100
105099CD*	2855PCB	2.7" x 1.6"	288	\$4.95	\$4.49	\$3.95	\$3.59
105128CD	2853PCB	4.4" x 2.0"	669	7.95	6.95	6.25	5.59
105152CD	2851PCB	5.5" x 3.1"	1450	9.95	8.95	7.95	6.95
105161CD	2852PCB	7.0" x 3.6"	2225	14.95	13.45	11.95	10.95

Die-Cast Aluminum Enclosures

High-quality die-cast aluminum cases come with channeled walls for easy PCB mounting. Ideal for RF circuits because the lid forms an effective screen against RFI interference. Made from aluminum, an excellent heat-sink, these cases are great for high temp circuits (up to 600°C). Complete with screws.

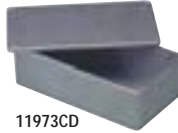

Part No.	Product No.	Size (L x W x D)	Wt. (lbs.)	1	10	50	100
11957CD	B5002	3.9" x 2.0" x 1.0"	0.2	\$5.95	\$5.39	\$4.85	\$4.35
11965CD	B5004	4.7" x 2.4" x 1.6"	0.4	7.95	7.15	6.44	5.79
11973CD	B5006	7.5" x 4.3" x 2.4"	1.2	13.49	12.15	10.95	9.85

Printed Circuit Boards for Above Enclosures

• Power/ground, perimeter bus with pad per hole

• Plated one side holes



Part No.	Product No.	Size (L x W)	No. of Holes	1	10	50	100
105101CD	5002PCB	3.5" x 1.5"	365	\$6.95	\$6.25	\$5.59	\$4.95
105128CD	2853PCB	4.4" x 2.0"	669	7.95	6.95	6.25	5.59
105161CD	2852PCB	7.0" x 3.6"	2225	14.95	13.45	11.95	10.95

Aluminum Enclosures

Ideal boxes for those projects that get left lying around! Put them in an economical aluminum enclosure. The enclosure comes in two pieces which slide together.



Part No.	Product No.	Size (L x W x D)	Wt. (lbs.)	1	10	50	100
11869CD	B2300	4.0" x 2.0" x 2.8"	0.2	\$5.45	\$4.69	\$4.22	\$3.79
11885CD	B2320	5.0" x 4.0" x 3.0"	0.4	7.89	6.15	5.55	4.99
11893CD	B2335	7.0" x 6.2" x 4.6"	0.8	10.95	9.25	8.29	7.49

Printed Circuit Boards for Above Enclosures

• Power/ground, perimeter bus w/ pad per hole

• Ground Bus

• Plated one side holes



Part No.	Product No.	Size (L x W)	No. of Holes	1	10	50	100
105110CD	2300PCB	3.4" x 2.4"	637	\$7.95	\$6.95	\$6.25	\$5.59
105136CD	2320PCB	4.5" x 3.3"	1266	9.95	8.95	7.95	6.95
105179CD	2335PCB	6.5" x 5.0"	2829	14.95	13.49	11.95	10.95

Metal Enclosures

High-quality metal enclosures are made to suit a large variety of electronics projects and applications. The base is made of aluminum. Slots are located on the sides of the cases for maximum cooling. Cases screw together and come with an attractive two-tone finish.

• Mounting screws and rubber feet included
• Glossy black textured steel top cover and ivory aluminum base

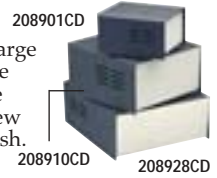

Part No.	Product No.	Size (L x W x D)	Wt. (lbs.)	1	10	50	100
208901CD	B2741A	4.0" x 3.3" x 2.2"	0.4	\$6.49	\$5.89	\$5.29	\$4.69
208910CD	B2743A	5.9" x 5.3" x 3.0"	0.8	7.99	7.19	6.49	5.89
208928CD	B2744A	7.3" x 6.3" x 2.8"	1.1	8.99	7.99	7.19	6.49
209349CD	B2746A	6.3" x 7.8" x 2.5"	0.9	12.99	11.69	10.49	9.49
209357CD	B2747A	7.5" x 9.8" x 3.2"	1.4	14.99	13.49	12.19	10.99

Printed Circuit Boards for Above Enclosures

• Power/ground, perimeter bus with pad per hole

• Plated one side holes

Part No.	Product No.	Size (L x W)	No. of Holes	1	10	50	100
105110CD	230APCB	3.4" x 2.4"	637	\$7.95	\$6.95	\$6.25	\$5.59
206578CD	2743APCB	4.6" x 4.3"	1684	6.99	6.29	5.69	5.19
206586CD	2746APCB	4.3" x 6.8"	2550	9.99	8.99	8.19	7.39
206594CD	2747APCB	5.5" x 8.0"	3906	13.99	12.59	11.29	10.19
105179CD	2505PCB	6.5" x 5.0"	2829	14.95	13.49	11.95	10.95

Heavy-Duty Instrument Cases

Both cases split apart for ease of working. Four plastic feet molded on unit. P/N 18876CD includes ventilation and speaker sound slots. • Color: gray



Part No.	Product No.	Size (L x W x D)	Wt. (lbs.)	1	10	50	100
18868CD	H2505	7.9" x 6.3" x 2.5"	0.8	\$7.39	\$6.69	\$5.99	\$5.39
18876CD	H2507	10.0" x 7.5" x 3.1"	1.4	8.99	7.99	7.28	6.55

Printed Circuit Boards for Above Instrument Cases

• Power/ground, perimeter bus with pad per hole

• Plated one side holes

Part No.	Product No.	Size (L x W)	No. of Holes	1	10	50	100
105179CD	2505PCB	6.5" x 5.0"	2829	\$14.95	\$13.49	\$11.95	\$10.95
105187CD	2507PCB	8.8" x 6.1"	4771	29.95	26.95	23.95	21.95

ABS Enclosures w/ Clear Tops

Made of gray ABS plastic w/ clear polycarbonate top cover. Includes screws for mounting boards or electronic components, rubber gasket for a tight seal on your equipment & drilled holes for mounting.



Part No.	Product No.	Size (L x W x D)	Wt. (lbs.)	1	10	50	100
141831CD	203C1	4.6" x 3.2" x 1.8"	0.3	\$8.95	\$8.09	\$7.25	\$6.55
141840CD	203D1	6.3" x 3.2" x 1.8"	0.4	9.95	8.99	8.09	7.25
141858CD	203F1	7.0" x 5.5" x 2.5"	0.8	11.95	10.79	9.69	8.69

Mounting Hardware for PC Boards

• 4 spacers, 8 screws and 8 washers



Part No.	Description	1	10	50	100
106551CD	PC board mounting hardware	\$1.79	\$1.65	\$1.45	\$1.35

For 3M Adhesive Rubber Feet, see page 120.



Component Cabinet



- Drawer can be divided into 4 sections (clear)
- Wall mountable cabinet (ABS black)
- Cabinet size: 6.0"D x 15"W x 7.9"H • Wt.: 4.7 lbs.
- Drawer size: 5.5"L x 2.7"W x 1.5"H
- Divider size: 2.4"L x 1.1"H

Includes: 20 clear plastic drawers, 20 dividers and 30 adhesive I.D. labels

* Prepackaged: order in increments of 10 or 50

Part No.	Description	1	10	50
81701CD	Component cabinet	\$15.95	\$13.95	\$12.49
85454CD	Drawer for cabinet	.39	.35	.29
85446CD	Divider for drawer	*	.19	.17

Plastic Fliptop Boxes

- Clear plastic box with a clear plastic lid and removable dividers
- 100255CD:** Size: 8.4"L x 4.5"W x 1.4"H
- 18 compartments (1.4" x 1.5" each)
- 148902CD:** Size: 10.2"L x 4.7"W x 1.6"H
- 12 compartments (1.7" x 2.3" each)



Part No.	Description	1	10	100
100255CD	18 compartments	\$2.25	\$1.95	\$1.75
148902CD	12 compartments	3.95	3.49	2.95

Plastic Fliptop Box

Double-Sided Box

- Unique double-sided design allows box to be opened from both top and bottom
- Size: 6.5"L x 4.0"W x 1.5"H



Part No.	Description	1	10	100
148865CD	Double sided box	\$2.59	\$2.29	\$1.95

Plastic Fliptop Case for SMDs

128 Compartments for Surface Mount Components

- 8 rows x 16 columns grid
- Fliptop openings on each bin
- Padded cover locks bins closed
- Perfect match to store P/N 156881CD SMD resistor assortment, pg 85
- Size: 11.0"L x 8.3"W x 1.7" Thick
- Weight: 1.4 lbs. • Color: gray



Includes: Labels for each bin

Part No.	Description	1	10
164267CD	SMD fliptop case	\$49.95	\$44.99

Stackable Drawers

- Case size: 4.5"L x 4.4"W x 2.3"H
- Drawer size: 4.4"L x 4.0"W x 0.9"H
- Color: blue/white

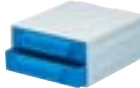

Part No.	Description	1	10	100
11906CD	Case/drawers	\$3.49	\$2.99	\$2.25

Bug Boxes

- Anti-static plastic
- Fits in bug cage (P/N 11332CD, below)
- **11341CD:** stores sixty 8-pin or thirty 16-pin DIPs
- **11375CD:** Designed to store all types of components
- Box size: 4.9"L x 3.3"W x 0.6"H



Part No.	Description	1	10	100
11341CD	30 compartments	\$3.95	\$3.49	\$3.15
11375CD	3 compartments/6 vertical & 6 horizontal dividers	4.49	3.95	3.49

Bug Trays

- Fits in bug cage (P/N 11332CD, below)
- **11826CD Open:** 1 compartment 4.6"L x 3.2"W x 0.4"H
- **11800CD Divided:** 10 compartments 3.2"L x 0.4"W x 0.4"H ea.
- Tray size: 4.8"L x 3.6"W x 0.5"H

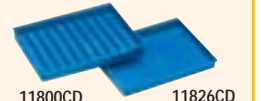

Part No.	Description	1	10	100
11826CD	Open bug tray	\$2.85	\$2.40	\$2.15
11800CD	Divided bug tray	3.45	3.10	2.79

Bug Cage

- Holds bug boxes or trays
- Modular and interlocking
- Color: blue • Weight: 0.7 lbs.
- Case size: 5.0"L x 3.9"W x 5.1"H

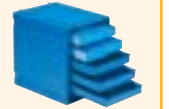

Drawers not included

Part No.	Description	1	10	100
11332CD	Bug cage	\$7.95	\$7.15	\$6.39

RCA Jacks, Adapters, Cables and Knobs

RCA Jacks and Adapter



- Standard RCA jacks for audio and video signals

* Prepackaged: order in increments of 10, 100 or 1000

Part No.	Description	1	10	100	1000
220581CD	.44"W x .56"D x .48"H	\$.45	\$.31	\$.28	\$.22
220556CD	.44"W x .56"D x .48"H	\$.45	\$.31	\$.28	\$.22
220572CD	.44"W x .56"D x .48"H	\$.45	\$.31	\$.28	\$.22
220564CD	.44"W x .56"D x .48"H	\$.45	\$.31	\$.28	\$.22
112475CD	.44"W x .58"D x .48"H	\$.39	\$.35	\$.31	\$.19
169501CD	.40"W x .85"D x .50"H	\$.39	\$.35	\$.31	\$.23
159484CD	.84"W x .38"H black	\$.49	\$.44	\$.39	\$.24
172339CD	.84"W x .38"H red	\$.49	\$.39	\$.31	\$.23
159441CD	RCA F to F adapter	1.99	1.79	1.49	1.25
215458CD	3.5mm mono jack to RCA	\$.89	\$.79	\$.69	\$.59
215440CD	3.5mm to 1/4" jack (mono)	\$.79	\$.69	\$.59	\$.59
196082CD	3.5mm to 1/4" jack (stereo)	\$.59	\$.39	\$.25	\$.25

RCA Audio/Video Cables



- Video/audio applications
- Color: black except as shown
- *Low loss

Part No.	Description	1	10	100
196808CD	5' Y: 1/8" F to 2 RCA M	\$.75	\$.65	\$.59
139037CD	5' Y: 1/8" M to 2 RCA M	2.25	1.89	1.42
215466CD	8' Y: 1/8" M to 2 RCA M	1.89	1.69	1.53
177527CD	6' 3 males to 3 males	2.99	2.69	2.45
184882CD	6' 3 males to 3 males*	3.29	2.49	1.75
225980CD	12' 3 males to 3 males†	4.49	3.99	3.65
225998CD	20' 3 males to 3 males†	7.99	7.19	6.45
183302CD	4' 2 males (red/black)	2.95	2.55	1.89
206973CD	4' male to male (yellow)	.99	.89	.79
29348CD	10' male to male (yellow)	1.69	1.49	1.25
215474CD	3' male to female (gray)	.89	.79	.69
183311CD	4' male to male	.99	.89	.79
106374CD	6' male to male	1.19	.89	.79
190617CD	10' male to male	1.49	1.29	.95

Instrumentation Knobs (1/4" Shaft Diameters)



- Fits 0.25" shafts
- 102787CD/104176CD/202286CD:** Brass insert and set screw for strength and durability
- Compatible with all rotary switches
- 136240CD:** • Used with 1/2-watt and 2-watt linear taper potentiometers, pg 90 & 91
- 138392CD:** • Brass insert, dual set screws
- Black knob with inset chrome top

Part No.	Mfr. Ref. No.	Cross Ref. No.	Size	1	10	100
102787CD	KN141		1.25"L x .54"H	\$.64	\$.41	\$.39
104176CD	KN143		.75"D x .49"H	.99	.85	.65
202286CD	K14SM		.80"D x .60"H	.79	.69	.64
136240CD	KN145		.54"D x .52"H	.65	.55	.49
138392CD	PKG90B		.85"D x .56"H	.79	.59	.54

Aluminum Instrumentation Knobs (1/8" and 1/4" Shaft Diameters)

Includes: Set screw for secure attachment

138384CD: • Coarse surface for sensitive control



Part No.	Mfr. Ref. No.	Cross Ref. No.	Figure	Description	Shaft Dia. (in.)	Size (in.)			Pricing		
						Dia.	Height		1	10	100
162481CD	K5-1/4S		1	Silver position pointer	.250	.50	.56	\$1.19	\$1.09	\$.96	
138384CD	KD500G		2	Silver position pointer	.125	.50	.63	1.39	1.25	.99	
162499CD	K5-1/4B		3	White position pointer	.250	.50	.56	1.55	1.39	1.07	
138481CD	KNO31		4	Black position pointer	.250	.61	.65	1.49	1.35	1.15	
138501CD	KNO32		4	Black position pointer	.250	.87	.75	1.79	1.59	1.39	
138510CD	KNO33		4	Black position pointer	.250	1.18	.87	2.49	2.24	1.95	



Hex
.187\"/>

Aluminum & Brass Threaded Standoffs

† Finish: Iridite (clear)¹ per MIL-C-5541-D;
bright tin plate²; stainless steel³



Hex
.250\"/>

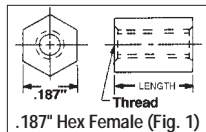

.187\"/>

4-40 Thread (Fig. 1) .187\"/>

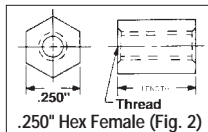

.250\"/>

4-40 Thread (Fig. 3) (Thread A: 0.250\"/>

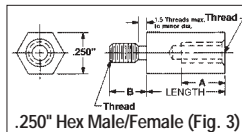

.250\"/>



* Prepackaged: order in increments of 10, 100 or 1000

Part Number	Metal†	Hex Length	Pricing		
			10	100	1000
175636CD	Brass ²	.187"	\$.15	\$.13	\$.096
102795CD	Brass ²	.240"	.21	.15	.10
133612CD	Alum ¹	.250"	.20	.14	.08
133639CD	Alum ¹	.500"	.22	.20	.11
139791CD	Alum ¹	.562"	.18	.15	.13
133647CD	Alum ¹	.625"	.14	.13	.11
133655CD	Alum ¹	.750"	.39	.23	.14
139184CD	Alum ¹	1.000"	.39	.32	.27

.250\"/>

4-40 Thread (Fig. 2) .250\"/>

* Prepackaged: order in increments of 10, 100 or 1000

Part Number	Metal†	Hex Length	Pricing			
			1	10	100	1000
139192CD	Alum ¹	.250"	*	\$.19	\$.14	\$.08
77500CD	Alum ¹	.375"	*	.20	.15	.09
134762CD	Alum ¹	.437"	*	.21	.18	.15
108370CD	Alum ¹	.500"	*	.25	.17	.10
77518CD	Alum ¹	.625"	.45	.35	.23	.14
133604CD	Alum ¹	.750"	.41	.35	.18	.13
139205CD	Alum ¹	1.000"	.49	.35	.25	.15

.250\"/>

6-32 Thread (Fig. 2) .250\"/>

* Prepackaged: order in increments of 10, 100 or 1000

Part Number	Metal†	Hex Length	Pricing			
			1	10	100	1000
77534CD	Alum ¹	.250"	*	\$.22	\$.14	\$.08
133591CD	Alum ¹	.375"	*	.29	.13	.09
77542CD	Alum ¹	.500"	*	.22	.17	.10
77551CD	Alum ¹	.625"	*	.25	.19	.14
77569CD	Alum ¹	.750"	*	.28	.21	.13
77577CD	Alum ¹	1.000"	.59	.35	.30	.16
143407CD	Alum ¹	1.500"	.69	.61	.49	.42
143440CD	Alum ¹	1.750"	.79	.59	.48	.41

3M Adhesive Rubber Feet

These are perfect for project boxes, providing a non-slip, non-scratch surface.



Part No.	Product No.	Type	Fig.	Pack	Dimensions (W" x H")	1	10	50
119618CD	SJ5012BLK4	Black cylindrical	1	4	.50 x .14	\$.59	\$.53	\$.48
142658CD	SJ5012BLKC	Black cylindrical	1	100	.50 x .14	5.95	5.35	4.79
142771CD	SJ5008BLKC	Black tapered square	2	100	.50 x .12	5.95	5.35	4.79
142682CD	SJ5018BLKC	Black tapered square	3	100	.50 x .23	8.95	7.95	6.95
126981CD	SJ5023BLK4	Black tapered square	4	4	.81 x .30	1.95	1.75	1.59
142666CD	SJ5023BLKC	Black tapered square	4	100	.81 x .30	14.95	12.95	11.49

See page 109 for Spacers/Standoffs Assortments.

SAE Hardware

• Zinc-plated steel



Prepackaged: order in increments of 100 or 1000

Part Number	Screw Size	Thread	Length (inches)	100 piece minimum	
				100	1000
38172CD	2-56	Std	.250	\$.025	\$.022
40951CD	4-40	Std	.250	.019	.011
40969CD	4-40	Std	.375	.019	.017
106809CD	4-40	Std	.500	.019	.017
106542CD	6-32	Std	.250	.017	.015
42446CD	6-32	Std	.375	.018	.016
42438CD	6-32	Std	.500	.03	.018
106796CD	8-32	Std	.500	.027	.024

Part Number	Screw Size	Thread	Dia. (inches)	100 piece minimum	
				100	1000
38164CD	2-56	Std	.183	\$.03	\$.025
211123CD	4-40	Sm	.184	.023	.011
40942CD	4-40	Std	.243	.025	.013
42420CD	6-32	Std	.306	.023	.014
51553CD	8-32	Std	.334	.028	.025

Part Number	Screw Size	Dia. (inches)	100 piece minimum	
			100	1000
211131CD	4	.237	\$.024	\$.018
106825CD	4	.281	.024	.018
106833CD	6	.373	.035	.018
106841CD	8	.377	.04	.018

Part Number	Screw Size	Dia. (inches)	100 piece minimum	
			100	1000
106850CD	4	.258	\$.018	\$.015
106868CD	6	.277	.018	.015
106876CD	8	.323	.018	.015

Part Number	Screw Size	Dia. (inches)	100 piece minimum	
			100	1000
106788CD	2	.161	\$.035	\$.022
211140CD	4	.201	.025	.018
40977CD	4	.242	.025	.018
42462CD	6	.240	.018	.009
51609CD	8	.279	.018	.013

PCB Standoff Mounting Hardware



28337CD 129251CD 148056CD 156831CD

• Snap "on" • Nylon
28337CD: 1.2"L x 0.6"W for 0.2" holes
129251CD: 0.9"L x 0.4"Dia. for 0.2"/0.3" holes
148056CD: 0.8"L x 0.5"W for 0.1"/0.2" holes
156831CD: 0.68"L x 0.32"Dia for 0.140" holes

• 10 piece minimum

Part No.	Mfr.	Cross Ref. No.	10	100	1000
28337CD	PCST		\$.12	\$.07	\$.04
129251CD	PCST2		.18	.11	.075
148056CD	PCST3		.09	.08	.06
156831CD	KCS10		.12	.10	.063

We'll Send It Today!

Just place your order by 6PM EST for same business day shipment.

Call for OEM pricing

Gray Flat Ribbon Cable – 28 AWG

103481CD



- Single edge red stripe for pin 1 orientation
- Insulation: polyvinyl chloride (PVC) • 28 AWG (7 x 36) • Center spacing: 0.05"
- Voltage rating: 300V • Stranded copper wire • Temp. rating: -20°C to +80°C
- Prepackaged and priced in increments of 10', 25', 100' or 500'

Part No.	Cross Ref. No.	Conductors	10 ft.	25 ft.	100 ft.	500 ft.
135538CD	171-10	10	\$1.49	\$3.20	\$11.50	\$47.50
37671CD	171-16	16	2.20	5.00	16.00	70.00
37719CD	171-20	20	1.95	4.50	16.00	65.00
37760CD	171-25	25	3.90	8.75	25.00	110.00
37807CD	171-26	26	3.49	8.00	25.00	120.00
37840CD	171-34	34	4.25	9.25	32.00	120.00
37911CD	171-37	37	5.90	13.75	40.00	150.00
37920CD	171-40	40	7.40	17.50	48.00	215.00
37954CD	171-50	50	6.75	14.50	49.00	210.00
103481CD	171-60	60	8.95	19.75	65.00	285.00

Multicolor Flat Ribbon Cable – 28 AWG

- Standard 10-color repeat sequence • 28 AWG (7 x 36)
- Center spacing: 0.05" • Voltage rating: 300V
- Temp. rating: -20°C to +80°C • Stranded copper wire
- Prepackaged and priced in increments of 10', 25', 100' or 500'



105718CD

Part No.	Cross Ref. No.	Conductors	10 ft.	25 ft.	100 ft.	500 ft.
112547CD	28RC10	10	\$1.95	\$4.50	\$17.50	\$70.00
105671CD	28RC16	16	3.25	7.25	24.00	100.00
105689CD	28RC20	20	3.95	9.00	30.00	125.00
105697CD	28RC25	25	6.29	14.25	49.95	219.95
105700CD	28RC34	34	6.50	14.50	53.00	210.00
105726CD	28RC40	40	8.69	19.553	69.49	299.95
105718CD	28RC50	50	10.95	24.95	85.95	384.95

Solid Hook-Up Wire – 22 AWG

- Temp. range: -55°C to +105°C • Passes UL VW-1 flame test
- MIL-W-16878D type B • Wt.: 100' (0.3 lbs.); 1000' (3.8 lbs.)
- For use with breadboards such as the JE20 series, pg 112



Part No.	Cross Ref. No.	Color	100 ft.	Part No.	Cross Ref. No.	Color	1000 ft.
36767CD	122BE/C	Blue	\$4.49	36775CD	122BE/K	Blue	\$29.95
36791CD	122BK/C	Black	4.49	36804CD	122BK/K	Black	35.95
36821CD	122G/C	Green	4.49	36839CD	122G/K	Green	29.95
36855CD	122R/C	Red	4.49	36863CD	122R/K	Red	39.99
36880CD	122W/C	White	4.49	36898CD	122W/K	White	39.99
36919CD	122Y/C	Yellow	4.49	36927CD	122Y/K	Yellow	29.95

Modular Telephone Cable – 28 AWG

- Color coded conductors • Flat modular cable
- PVC jacket • Gray • 7 x 43 stranded

103430CD

Part No.	Cross Ref. No.	Conductors	100 ft.	1000 ft.	10000 ft.
103430CD	MTC4	4	\$3.30	\$30.00	\$250.00
103448CD	MTC6	6	7.00	50.00	430.00
103450CD	MTC8	8	10.00	62.00	450.00

2-Conductor Stranded Power/Speaker Cable – 24 AWG

- Black wire with white polarity stripe
- Temperature rating: 20°C to 60°C
- Stranded copper wire (7 x 32) • Operating voltage: 300V



Part No.	Cross Ref. No.	Wt. (lbs.)	100 ft.	Part No.	Cross Ref. No.	Wt. (lbs.)	1000 ft.
100280CD	224BK/C	0.8	\$5.59	100298CD	224BK/K	7.8	\$39.95

RG Type Bulk Coaxial Cable

- RG58/U & RG58A/U (50Ω): Nom. cap.: 27pF/ft.; center resist.: 10.4Ω/1kft. @ 77°F
- RG59/U (75Ω): Nominal capacitance: 19pF/ft.; center resist.: 16.5Ω/kft. @ 77°F
- RG174/U (50Ω): Nominal capacitance: 30.8pF/ft.; center resist.: 97Ω/kft. @ 77°F
- Prepackaged and priced in increments of 100' or 1000'

Part No.	Cross Ref. No.	Description	100 ft.	1000 ft.
102226CD	RG58/U	For ethernet, oscilloscopes (solid 20AWG) ...	\$12.00	\$96.00
116898CD	RG58A/U	For ethernet, oscilloscopes (stranded 20AWG) ...	16.00	140.00
102218CD	RG59/U	For CATV & video patch cords (solid 22AWG) ...	13.00	110.00
112037CD	RG174/U	For ethernet, oscilloscopes (stranded 26AWG) ...	19.00	169.00

Category 5 Network Cable

- 100MHz • 8C • 4 twisted pairs • UTP
- Insulation: polyethylene • Nom. OD.: 189"
- Nom. impedance: 100Ω

- Solid: uses modular plug P/N 119343CD, pg 195
- Stranded: uses modular plug P/N 79281CD, pg 195
- Prepackaged and priced in increments of 25' or 100'



118130CD

See pages 193 - 195 for more Modular Cable and Connectors



24 AWG UTP Category 5 Enhanced – 350MHz

Part No.	Description	25 ft.	100 ft.	1000 ft.
176225CD	Solid (gray)	\$5.00	\$17.00	\$100.00
176233CD	Stranded (gray)	6.00	21.00	180.00
201582CD	Stranded (blue)	6.00	18.00	160.00

24 AWG UTP Category 5 – 100MHz

Part No.	Description	25 ft.	100 ft.	1000 ft.
118113CD	Solid (gray)	\$4.59	\$16.49	\$129.50
118130CD	Stranded (gray) (7/32 AWG)	5.95	19.35	164.50

Multiconductor Shielded Computer Communication Cable – 24 AWG

- Stranded copper wire, multi-colored insulation
- Insulated with polyvinyl chloride (PVC)
- Voltage rating: 300V • Color: gray • Drain wire
- 24 AWG (7 x 32 AWG) • Shielded 100% w/ aluminum mylar
- Prepackaged and priced in increments of 25' or 100'

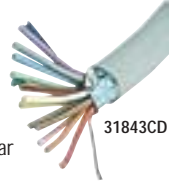

31843CD

Part No.	Cross Ref. No.	Conductors	Diameter	25 ft.	100 ft.	1000 ft.
31860CD	SC4	4	0.20"	\$4.75	\$17.00	\$140.00
31878CD	SC9	9	0.23"	11.25	35.00	270.00
31843CD	SC15	15	0.28"	14.75	49.00	430.00
31851CD	SC25	25	0.37"	22.25	71.00	590.00

Stranded Hook-Up Wire – 18/20/22 AWG

300 Volts

- 80°C • PVC insulation • CSA: TR-64 • UL style: 1007
- Temperature range: -40°C to +80°C • Sold in 100' rolls



Part No.	Cross Ref. No.	AWG	Strands (No. x AWG)	Color	Wt. (lbs.)	1	10
126084CD	223SBK/C	22	7 x 30	Black	0.4	\$3.89	\$3.55
126033CD	223SR/C	22	7 x 30	Red	0.4	3.89	3.55
126076CD	223SW/C	22	7 x 30	White	0.4	3.89	3.55
125840CD	203SBK/C	20	10 x 30	Black	0.6	4.95	4.49
125794CD	203SR/C	20	10 x 30	Red	0.5	4.95	4.49
125831CD	203SW/C	20	10 x 30	White	0.5	4.95	4.49
125786CD	183SBK/C	18	16 x 30	Black	0.8	5.79	5.25
125735CD	183SR/C	18	16 x 30	Red	0.8	5.79	5.25
125751CD	183SW/C	18	16 x 30	White	0.8	5.79	5.25

Twisted Pair Cable – 24 AWG

- PVC insulation • Use for hook up wire • Stranded tinned wire (7 x 32)
- Reduced EMI • Wt.: 100' (0.5 lbs.); 1000' (4.7 lbs.) • 80°C • 300 V



Part No.	Cross Ref. No.	Color	100 ft.	Part No.	Cross Ref. No.	Color	1000 ft.
105911CD	224GW/C	Green/white	\$5.49	105806CD	224GW/K	Green/white	\$44.95
173147CD	224RW/C	Red/white	5.49	173155CD	224RW/K	Red/white	44.95
173163CD	224BW/C	Black/white	5.49	173171CD	224BW/K	Black/white	44.95

Kynar™ Wire Wrap Wire – 30 AWG

- Assorted color coded insulation • Used for prototyping
- Color coded Kynar™ (Polyvinylidene Fluoride) insulation
- Silver plated copper (solid conductor) • UL 1423
- Temperature: -40°C to +125°C • See pg 129 for sockets
- Wire wrap tools, pg 166 • Passes UL VW-1 flame test



22541CD

Part No.	Color	Wt. (lbs.)	100 ft.	Part No.	Color	Wt. (lbs.)	1000 ft.
22541CD	Blue	0.1	\$4.95	22550CD	Blue	0.6	\$29.95
22576CD	Black	0.1	4.95	22584CD	Black	0.6	29.95
22630CD	Red	0.1	4.95	22648CD	Red	0.6	29.95
22664CD	White	0.1	4.95	22672CD	White	0.6	29.95
22605CD	Green	0.1	4.95	22613CD	Green	0.6	29.95
22699CD	Yellow	0.1	4.95	22701CD	Yellow	0.6	26.95

Call for OEM pricing

Nylon Cable Ties

Standard



- Cable ties made from UL approved Nylon 66
- Temperature range: -40°C to +85°C
- Flammability rating: UL 94V-2
- Color: clear (except P/N 182676CD)
- Sold in increments of 100 or 1000

Part No.	Tensile Strength (lbs.)	Dimensions (L" x W")	100	1000
70560CD	18	3.1 x 0.10	.025	\$.015
126543CD	18	4.0 x 0.10	.02	.014
182676CD	18*	4.75 x 0.13	.035	.025
182650CD	18	5.5 x 0.13	.035	.025
139150CD	18	8.0 x 0.10	.05	.031
182668CD	18	8.0 x 0.13	.075	.05
182684CD	18	8.0 x 0.18	.036	.033
70906CD	40	5.8 x 0.10	.035	.029
190756CD	40	10.0 x 0.14	.099	.075
190772CD	40	11.0 x 0.19	.10	.07
190764CD	40	13.0 x 0.14	.10	.075

Weather Resistant



- Contain Carbonate A for greater resistance to ultra violet rays in outdoor use
- Color: black
- Sold in increments of 100 or 1000

Part No.	Tensile Strength (lbs.)	Dimensions (L" x W")	100	1000
139125CD	18	3.0 x 0.90	\$.045	\$.029
104141CD	18	4.0 x 0.10	.044	.029
104133CD	40	5.8 x 0.10	.047	.031
190781CD	40	8.0 x 0.13	.085	.065
190799CD	40	10.0 x 0.14	.10	.09
190801CD	40	13.0 x 0.14	.113	.088
139141CD	50	4.8 x 0.18	.027	.024

Cable Tie Assortments

- Tensile strength: 18-50 lbs.
- 145701CD: 1000 pcs. (4"L); 10 colors
- 150412CD: 500 pcs. (4"L); 300 pcs. (8"L); 50 pcs. (11"L), 5 colors



Part No.	Weight (lbs.)	1	10	50
145701CD	0.7	\$9.49	\$8.49	\$7.39
150412CD	1.7	13.95	11.49	9.95

AC Cord Cable Tie

- Reusable
- Length: 6"
- Color: black
- Sold in increments of 100 or 1000



Part No.	Description	100	1000
183185CD	Cable tie	\$.09	\$.072

Cable Tie Tool

- 2.5 - 5mm width (of cable)
- Tension adjustable
- Twist to cut surplus tie end
- Spring return action • Plastic



Part No.	Description	1	10	100
182297CD	Cable tie tool	\$12.25	\$11.05	\$9.95

Cable Clamps

- Tie mount and screw tab cable clamps
- Material: UL approved nylon 66, 94V-2
- Sold in increments of 10, 100 or 1000

SALE



Part No.	Mfr. Cross Reference No.	Description	10	100	1000
182941CD	0505HC-101S	Tie mount cable .75"D; 4-way self adhesive	\$.07	\$.055	\$.042
182300CD	0510HC-2	Tie mount cable .5"D; 1/4" screw hole	.17	.15	.14
182318CD	0519ATC-17	Tie mount cable .7"D ADJ; 2-way #6 flat head screw	.59	.52	.46
182376CD	0519ATC-22	Tie mount cable .9"D ADJ; 2-way #6 flat head screw	.35	.30	.27
182334CD	0520FC-1	Tie mount cable .1"D; self adhesive	.17	.15	.12
182342CD	0520FC-2	Tie mount cable .2"D; self adhesive	.19	.16	.12
173711CD	UC0	Cable clamp for 1/8" cable	.09	.027	.018
173729CD	UC0.5	Cable clamp for 3/16" cable	.035	.032	.019
173737CD	UC1	Cable clamp for 1/4" cable	.14	.09	.065
134754CD	B0375	Cable clamp for 3/8" cable	.09	.035	.018
173753CD	UC3	Cable clamp for 1/2" cable	.09	.039	.025

Nylon Cable Tie Mounts

- Screw tab & cradle mount adhesive
- Sold in increments of 10, 100 or 1000

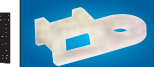
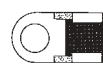

171213CD
71407CD
71394CD
71386CD

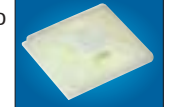

Part No.	Description	10	100	1000
70594CD	0.8"L x 0.4"W screw 4-way cable tie, used w/ 0.2"W max	\$.15	\$.09	\$.05
171213CD	0.5" square adhesive 4-way cable tie, used w/ 0.1"W max	.15	.13	.094
71407CD	0.9" square adhesive 4-way cable tie, used w/ 0.1"W max	.18	.16	.13
71394CD	1.1" square adhesive 4-way cable tie, used w/ 0.2"W max	.23	.19	.14
71386CD	1.1" square adhesive 2-way cable tie, used w/ 0.4"W max	.25	.19	.13
173761CD	0.6"L x 0.4"W cable tie, saddle type	.15	.125	.075

Cable Tie Assorted Kits

- 195207CD: 50 pcs. assorted colors; 25 pcs. 8" and 25 pcs. 11"
- 195830CD: 25 pcs. each 3 3/4", 4 3/4", and 7 1/2" clear



Part No.	Mfr. Cross Ref. No.	1	10	50
195207CD	VP-50-811C	\$2.29	\$2.09	\$1.85
195830CD	BP-75 CLEAR	1.79	1.65	1.45

Pressure Sensitive Wire Marker

- Easy release vinyl cloth markers feature a strong, pressure-sensitive adhesive, for long lasting bond on a wire or cable. Black non-smear legends on white background for easy identification.
- Convenient pocket-size booklet
- 10 sheets numbered 1 to 45 each sheet

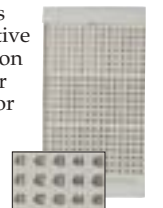

Part No.	Product No.	1	10	100
216813CD	TCWM-3	\$12.95	\$11.65	\$8.95

Nylon Cable ID Ties and Tabs



- 71061CD: Clear ID tab (0.98" x 0.31")
- 182692CD: White ID tab (18 lb. tensile strength)
- 135175CD: Nylon cable tie ID marker
- Sold in increments of 10, 100 or 1000

Part No.	Size	10	100	1000
71061CD	4.0"L x 0.1"W	\$.10	\$.08	\$.072
182692CD	8.0"L x .10"W	.12	.07	.05
135175CD	2.0"L x 0.8"W x .02"T	.20	.135	.10

Cable Sleeve

Clean Cut Expandable Sleeving

- Flame resistant
- Applications: protecting wires, cables and hoses
- Operating temp.: -70°C to 125°C
- Sold in spools of 25'

SALE

162157CD

Part No.	Product No.	Actual/Expanded Dia.	1	10
162157CD	CCPT2X	.250"/.440"	\$15.95	\$14.95
162165CD	CCPT3X	.500"/.750"	17.95	14.49

Self Adhesive Wire Marker

- 90 markers per number
- Stick to wires for permanent identification
- Cloth tape label numbered 0-9
- Used after or before terminal



Part No.	Product No.	1	10
182262CD	0215WMB-1	\$9.95	\$8.95

3M Tape Wire Marker

- For marking wires with numerical sequence
- Self adhesive tapes numbered 0-9
- Size: (tape) 96"L x 0.25"W



Part No.	Description	1	10
159231CD	Numerical tape dispenser	\$30.95	\$27.85

Cable Markers

- UL approved natural nylon
- 10 piece minimum

SALE



Part No.	Size	10	100	1000
182705CD	1.5"L x .75"W	\$.12	\$.11	\$.10
182713CD	2.5"L x 1.76"W	.27	.25	.23

Heat Guns, Cable Clips, Wire Connectors and Accessories

Call for OEM pricing - we carry major manufacturers.

Nail-In Cable Clips

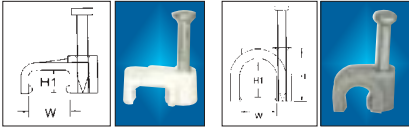

190810CD

190861CD

- Material: impact resistant PE
- With nails inserted
- Sold in increments of 100 or 1000

For telephone cords; white

SALE

Part No.	Mfr. Cross Ref. No.	W x H x H1 (in.)	100	1000
190810CD	NFO.7	.22 x .22 x .12	\$.07	\$.02
190828CD	NF1.2	.24 x .21 x .15	.05	.02
190836CD	NF1.6	.31 x .31 x .20	.05	.02
190844CD	NF2.0	.33 x .31 x .20	.015	.013
190852CD	NF2.8	.59 x .50 x .34	.05	.02

For general round cables; gray

Part No.	Mfr. Cross Ref. No.	W x H x H1 (in.)	100	1000
190861CD	NCO.35N	.14 x .23 x .15	\$.085	\$.035
190879CD	NCO.5N	.20 x .30 x .21	.05	.02
190887CD	NC1N	.24 x .35 x .26	.085	.035
190895CD	NC2N	.31 x .45 x .34	.05	.02
190908CD	NC3N	.39 x .53 x .41	.05	.02

Round-Type Strain Relief Bushings

- Material: UL approved nylon 66, 94V-2
- Color: black
- Used extensively for protecting cords and to prolong cord life
- Sold in increments of 10



Part No.	Cable Type	Lgth (in.)	10	100	1000
182351CD	SVI/SVT	.43	\$.055	\$.035	\$.03
182369CD	SJ/SJT; 16 AWG	.58	.19	.11	.09
182377CD	SJC; 18 AWG	.58	.27	.23	.17

Bushing Assembly Tool

- For use with strain relief bushings, above



Part No.	Description	1	10	100
73470CD	Bushing tool	\$.31.95	\$28.75	\$25.85

Wire Connectors



- Material: UL approved nylon 66, 94V2
- Quick and secure method to splice control wires
- Strip wire before application
- Twist on type
- Material: PVC with metal spring, except P/N 182449CD nylon 66, 94-2 and P/N 140716CD PE - metal inside

182449CD: UL/CSA approved
• Sold in increments of 10, 100 or 1000

Part No.	Description	Color	10	100	1000
182449CD	Crimp 16-14 AWG*	Natural	\$.06	\$.055	\$.049
182511CD	Wire-nut 16 AWG	Blue	.05	.038	.026
140716CD	Wire IDC 22-18 AWG	Red	.13	.11	.083

* Requires crimping tool (P/N 72995CD, pg 164)

Heat Shrink Tubing

- 2:1 uniform shrink ratio
- Color: black
- Temperature range: -45°C to +125°C

PVC Heat Shrink Flat Film

- Shrink temperature: 175°C
- Precut 39" length; sold as 1 increment

Part No.	Unshrunk		Shrunk		1*	10*	100*
	Flat	Cir. Dia.	Cir. Dia.	Cir. Dia.			
70631CD	5/16"	1/4"	1/8"	1/8"	\$1.69	\$1.55	\$1.39
70623CD	1/2"	5/16"	3/16"	3/16"	1.69	1.45	1.09
70666CD	13/16"	9/16"	1/4"	1/4"	1.69	1.55	1.39

Polyolefin Heat Shrink Tubing

- Dielectric strength: 1300V
- Flexible
- Flame retardant
- Shrink temp.: 121°C

* Precut 39" length; sold as 1 increment

Part No.	Before		After (Dia.)		1*	10*	100*
	Before	After (Dia.)	After (Dia.)	After (Dia.)			
71327CD	1/16"	1/32"	1/32"	1/32"	\$.59	\$.51	\$.46
71870CD	3/32"	3/64"	3/64"	3/64"	.59	.49	.44
71280CD	1/8"	1/16"	1/16"	1/16"	.69	.59	.54
72063CD	1/4"	1/8"	1/8"	1/8"	.99	.81	.72
226245CD	3/8"	3/16"	3/16"	3/16"	1.09	.98	.88
216477CD	1/2"	1/4"	1/4"	1/4"	1.15	.99	.89

PVC Heat Shrink Tubing

- 2:1 uniform shrink ratio
- Color: black
- Shrink temp.: 125°C
- Sold in 10' and 100' increments

Part No.	Dia. before (mm)	10 ft.		100 ft.	
		10 ft.	100 ft.	10 ft.	100 ft.
184721CD	.12" (3)	\$.19	\$10.50		
182730CD	.16" (4)	1.39	12.50		
182748CD	.20" (5)	1.45	13.00		
182756CD	.24" (6)	1.49	13.50		
182764CD	.31" (8)	1.79	16.00		
182772CD	.38" (11)	2.80	19.00		
182781CD	.59" (15)	3.50	30.00		

171-Pc. Solderless Terminal Kit

- Clear, hinged plastic box
- Use crimping tool P/N 72995CD, pg 164

170 Terminals and Connectors!



Qty.	Description	Wire Gauge	Blade Size	Qty.	Description	Wire Gauge	Blade Size
10	Male spade	16-22	1/4"	10	Ring term.	14-16	#10
10	Male spade	14-16	1/4"	5	Ring term.	10-12	#10
10	Fem. spade	16-22	1/4"	5	Ring term.	10-12	#14
10	Fem. spade	14-16	1/4"	10	Spade term.	16-22	#6
10	Ring term.	16-22	#6	10	Spade term.	16-22	#8
10	Ring term.	16-22	#8	10	Spade term.	14-16	#10
10	Ring term.	16-14	#10	10	Butt conn.	16-22	-
15	Ring term.	14-16	#6	10	Butt conn.	14-16	-
10	Ring term.	14-16	#8	5	Butt conn.	10-12	-

Part No.	Description	1	10	25
10989CD	Terminal kit	\$.89.95	\$7.95	\$7.25



Phone 1-800-831-4242
Online www.Jameco.com

Order Anytime 24x7x365

Fax 1-800-237-6948

Heat Gun/Stripper

Dual-Setting

- Use with heat shrink material
- Works with spot-dry paint, plaster, spackle cure adhesives
- Will remove adhesive-applied tiles and linoleum without chipping
- Dual heat setting: 600°F/1100°F
- Thaw pipes, frozen locks and loosen rusted bolts
- UL listed
- Weight: 1.8 lbs.
- Size: 9.3"L x 7.0"W



Part No.	Description	1	10	25
76865CD	Heat gun	\$39.95	\$35.95	\$31.95
217816CD	Heat shrink attachment	1.95	1.85	1.75
217832CD	Air spreader	1.95	1.85	1.75

Weller® 250-Watt, 3-Setting Industrial Heat Gun

- 750°F to 800°F hot air at nozzle; 3-position switch; hot-off-cool
- Designed for assembly and repair applications such as shrink tubing and vinyl, epoxy curing/drying/cooling
- 120VAC @ 60Hz
- ESD safe
- Long-life heater and fan components
- 3-wire grounded plug; 6' cord



Part No.	Product No.	Wt. (lbs.)	1	10
191943CD	6966C	1.2	\$119.95	\$107.95

WAHL® 1,200°F Portable Heat Gun

- Portable and flameless heat
- Temperatures up to 1,200°F (650°C)
- Typical applications: shrink tubing, activate adhesives and potting compounds, form plastics and laminates and preheat flux
- Each cartridge (disposable butane lighter) provides approximately 20 minutes of heat
- Includes disposable gas lighter
- Electronic ignition
- Size: 4.8"L x 0.9"W
- One-year warranty

ETL listed



Part No.	Description	1	10
150691CD	Portable flameless heat gun	\$.26.95	\$24.25

Insulated Solderless Terminals

- Insulation thickness: .030"
- Funnel ramp entry
- Temperature to 105°C
- Use with crimping tool P/N 72995CD, pg 164

Ring Solderless

Part No.	Color	Wire Gauge	Stud	10	100	1000
103683CD	Red	16-22	#6	\$.11	\$.07	\$.05

Spade Solderless

Part No.	Color	Wire Gauge	Stud	10	100	1000
103587CD	Red	16-22	#6	\$.13	\$.06	\$.05
103595CD	Blue	14-16	#8	.125	.075	.06

Disconnect Solderless

Part No.	Descrip.	Color	Gauge	Blade	10	100	1000
106921CD	Female	Red	16-22	.187"	\$.12	\$.07	\$.05
103667CD	Female	Red	16-22	.25"	.12	.07	.05
109111CD	Female†	Red	16-22	.25"	.17	.11	.055

† includes hood

D-Subminiature Connectors

- Dielectric withstanding voltage: 1000VAC (one minute)
- Nylon, flame retardant, 94V-0 rated, glass filled
- Low-cost, high performance, precision formed crimp contacts
- Standard mounting method with 0.120" diameter mounting holes
- Insulation resistance: 5000MΩ
- UL/CSA recognized and certified



Crimp-Type Contacts

- Current rating: 1.2A to 3.7A
- Intermateable with any size 20 D-sub dimensionally complying with MIL-C-24308
- Crimp snap-in contacts allows loading of only the number of contacts being used

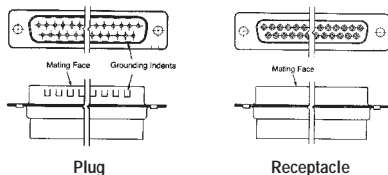

Zinc-Plated Shell



Part No.	Product No.	Cont.	Description	1	10	100
222640CD	205204-1	9	Plug	\$.95	\$.85	\$.63
222658CD	205206-1	15	Plug	1.39	1.24	.92
222666CD	205208-1	25	Plug	1.19	1.10	.82
222674CD	205210-1	37	Plug	1.69	1.49	1.10
222682CD	205212-1	50	Plug	2.10	1.79	1.35
222691CD	205203-1	9	Receptacle	1.10	.99	.77
222703CD	205205-1	15	Receptacle	1.25	1.10	.82
222711CD	205207-1	25	Receptacle	1.05	.95	.71
222720CD	205209-1	37	Receptacle	1.69	1.49	1.10
222738CD	205211-1	50	Receptacle	2.10	1.79	1.69

Tin-Plated Shell



Part No.	Product No.	Cont.	Description	1	10	100
222754CD	205204-3	9	Plug	\$1.29	\$1.15	\$.85
222762CD	205206-2	15	Plug	1.49	1.29	.95
222771CD	207464-1	25	Plug94	.80	.61
222789CD	205210-2	37	Plug	1.69	1.49	1.10
222797CD	205204-4	9	Plug*	.83	.75	.55
222800CD	205206-3	15	Plug*	.99	.89	.65
222818CD	207464-2	25	Plug*	.88	.78	.58
222826CD	205210-3	37	Plug*	1.68	1.49	1.12
222834CD	205212-3	50	Plug*	1.79	1.59	1.19
222842CD	205203-3	9	Receptacle	.69	.59	.52
222914CD	205205-2	15	Receptacle	.88	.78	.58
222922CD	207463-1	25	Receptacle	.99	.89	.68
222931CD	205209-2	37	Receptacle	1.19	1.05	.78
222949CD	205211-2	50	Receptacle	2.10	1.79	1.35

* With grounding indents

Solder-Cup Contacts

- Current rating: 1.2A to 3.0A
- Intermateable with other D-sub connectors
- One-piece 94V-0 rated plastic insert
- Preloaded duplex-plated solder-cup contacts
- Shields offer full EMI shielding and ESD insulation
- Anti-solderwicking contact design

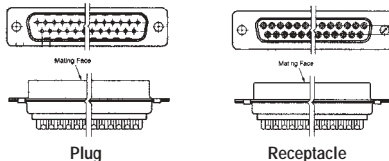

Zinc-Plated Shell



Part No.	Product No.	Cont.	Description	1	10	100
222957CD	747904-4	9	Plug	\$1.89	\$1.59	\$1.32
222965CD	747908-4	15	Plug	2.65	2.19	1.75
222973CD	747912-4	25	Plug	3.69	3.10	2.49
222981CD	747916-4	37	Plug	5.45	4.56	3.79
223036CD	747905-4	9	Receptacle	2.65	2.23	1.76
223044CD	747913-4	25	Receptacle	4.75	3.99	3.19

Tin-Plated Shell



Part No.	Product No.	Cont.	Description	1	10	100
222990CD	747904-2	9	Plug	\$1.69	\$1.55	\$1.15
223001CD	747908-2	15	Plug	2.79	2.49	1.85
223010CD	747912-2	25	Plug	3.29	2.95	2.19
223028CD	747916-2	37	Plug	5.39	4.65	3.39
223052CD	747905-2	9	Receptacle	2.35	2.09	1.55
223061CD	747909-2	15	Receptacle	3.45	2.99	2.19
223079CD	747913-2	25	Receptacle	4.10	3.69	2.72
223087CD	747912-2	37	Receptacle	6.65	5.69	4.19

D-Sub Female Solder-Cup Snap-In Contact

- Contact material: phosphor bronze
- Contact termination area plating: gold flash over nickel
- No insulation support
- Prepackaged: order in increments of 10, 100 or 1000



Part No.	Product No.	AWG	10	100	1000
223319CD	66569-3	18 (max.)	\$.27	\$.21	\$.19

D-Sub Crimp Contacts

- Pin material: brass; socket material: phosphor bronze
- Contact plating
- *A: Select – gold flash over nickel on entire contact, with additional gold (.000030) on mating end;
- *B: duplex – gold (.000030) on mating end, tin-lead on termination end, with entire contact nickel underplated;
- *C: gold flash over nickel on entire contact;
- *D: gold flash on mating end, tin-lead on termination end, with entire contact nickel underplated
- For use with AMP D-sub connectors (see left)

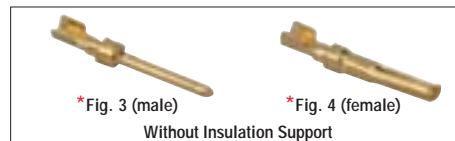

Male Crimp Contacts

- Prepackaged: order in increments of 10, 100 or 1000

Part No.	Product No.	Desc.*	AWG	10	100	1000
223095CD	1-66507-0	1C	28-24	\$.24	\$.17	\$.12
223124CD	66682-4	1A	28-24	.28	.19	.14
223132CD	745254-7	1C	26-22	.25	.18	.128
223141CD	745254-6	1A	26-22	.28	.20	.14
223159CD	1-745254-6	1B	26-22	.25	.18	.13
223167CD	1-66506-0	1C	24-20	.16	.15	.12
223175CD	205202-7	3C	24-20	.24	.17	.14
223183CD	5-66506-9	1D	24-20	.21	.15	.13
223191CD	66506-9	1A	24-20	.16	.15	.10
223204CD	5-66506-7	1B	24-20	.24	.17	.12
223212CD	745229-4	3A	22-18	.26	.24	.19

Female Crimp Contacts

- Prepackaged: order in increments of 10, 100 or 1000

Part No.	Product No.	Desc.*	AWG	10	100	1000
223221CD	1-66505-0	2C	28-24	\$.18	\$.12	\$.09
223239CD	66683-4	2A	28-24	.31	.22	.15
223247CD	745253-6	2A	26-22	.30	.20	.14
223255CD	1-66504-0	2C	24-20	.17	.15	.11
223263CD	205201-7	4C	24-20	.28	.23	.18
223271CD	5-66504-7	2D	24-20	.16	.12	.10
223280CD	205201-5	4A	24-20	.32	.26	.20
223298CD	66504-9	2A	24-20	.17	.15	.13
223301CD	6-66504-0	2B	24-20	.27	.18	.13

D-Sub Pin Insertion/Extraction Tool

- Insertion/extraction tool: red/white plastic body; exchangeable tips



Part No.	Description	1	10	100
19094CD	Insertion/ext. tool	\$.349	\$2.99	\$2.59

See the yellow and green highlighted items.

Jameco Special Values!

Details on page 4.



D-Subminiature Connectors, Mounting Hardware & Hoods

4-40 Screw Hardware for D-Subminiature Connectors

4-40 x .187" Jack Screws and Hex Nuts



* Prepackaged: order in increments of 10, 100 or 1000

Part No.	Description	1	10	100	1000
169931CD	.275"L jack screw	* .15	.13	.11	.10
172603CD	.315"L jack screw	* .14	.11	.10	
102816CD	.435"L jack screw49	.46	.41	.37
108986CD	.515"L jack screw55	.50	.45	.40
175636CD	.187"L hex nut	* .15	.13	.096	
102795CD	.240"L hex nut	* .21	.15	.10	
196293CD	.252"L hex nut	* .21	.12	.08	
125014CD	4-40 x 1.65"L plastic beige thumbscrew39	.35	.28	.20

4-40 Screw Sets



102808CD: 4-40 screw (.30"L) and retainer set
16547CD: 4-40 x .187" jack screw (.31"L thread), washer, lock washer, and nut set

* Prepackaged: order in increments of 10, 100 or 1000

Part No.	Description	10	100	1000
102808CD	Screw/retainer set	\$.35	\$.30	\$.20
16547CD	Screw/nut set31	.25	.17

D-Subminiature Connector Hoods

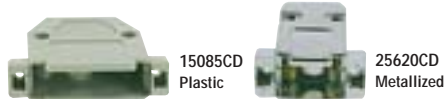

• Use with D-sub solder cup and housing style connectors (hardware included)

D Series: plastic hood with strain relief (gray)
MD Series: metal coated plastic hood w/ strain relief
MH Series: die-cast metal hood with strain relief

Part No.	Mfr. Cross Ref. No.	Connector	1	10	100	1000
15721CD	DB9H	9-pin	\$.49	\$.45	\$.39	\$.35
25620CD	MDB9H	9-pin59	.49	.39	.35
147740CD	DB9MH	9-pin	1.45	1.29	1.15	.99
15018CD	DA15H	15-pin49	.45	.40	.35
25566CD	MDA15H	15-pin56	.44	.36	.31
15085CD	DB25H	25-pin45	.39	.35	.32
25603CD	MDB25H	25-pin59	.49	.42	.35
15106CD	DB25MH	25-pin	1.39	1.19	1.09	.89
15456CD	DC37H	37-pin59	.55	.45	.39
25611CD	MDC37H	37-pin75	.69	.59	.53
15659CD	DD50H	50-pin99	.85	.75	.65

25-Pin Dual Plastic Hood

Designed for custom applications requiring two D-sub connectors. Applications include custom jumper boxes and interconnects.



Part No.	Description	1	10	100	500
34091CD	25-pin, plastic dual ..	\$.95	\$.85	\$.75	\$.59

D-Subminiature Connectors

- Metal shells are tin-plated for improved EMI/RFI shielding
- Insulation resistance: minimum 1000MΩ at 500VDC
- Dielectric withstanding voltage: 1000V (one minute)
- Current rating: 1A to 5A
- High temperature thermoplastic
- Insulation material: PBT, UL rated 94V-0

Right Angle PC Mount Connectors

0.318" Set Back

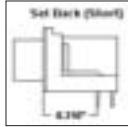

- Short style
- Lead length: .138"
- Lead spacing: .115"
- Shell: metal
- Current rating: 1A



Part No.	Mfr. Cross Ref. No.	Cont.	Gender	1	10	100	500
104942CD	DB9P318	9	M	\$.55	\$.50	\$.40	\$.30
104951CD	DB9S318	9	F	..60	.55	.49	.45
71124CD	DA15P318	15	M	..69	.59	.55	.49
77956CD	DA15S318	15	F	..79	.69	.65	.45
168743CD	HDDB15S318*	15	F	..49	.42	.34	.31
71466CD	HDDB15S318*	15	F	..59	.53	.42	.31
15149CD	DB25P318	25	M	..79	.65	.55	.42
15181CD	DB25S318	25	F	..89	.79	.72	.65
71706CD	DC37P318	37	M	..99	.85	.72	.59
78182CD	DC37S318	37	F	1.15	.95	.69	.49

* High Density

0.590" Set Back

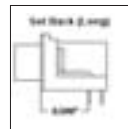

- Lead length: .178"
- Lead spacing: .104"
- Current rating: 1A
- Shell: Metal; except P/N 15763CD plastic
- Long style



SALE

Part No.	Mfr. Cross Ref. No.	Cont.	Gender	1	10	100
15763CD	DB9P590PL	9	M	..29	\$.25	\$.19
104969CD	DB9P590	9	M	..99	.83	.72
104977CD	DB9S590	9	F	..89	.79	.75
104993CD	DA15S590	15	F	..99	.85	.59
189624CD	DB25P590†	25	M	..85	.76	.69
105005CD	DB25P590	25	M	..99	.89	.79
105013CD	DB25S590	25	F	1.25	1.12	.99

† Without board tabs

IDC Ribbon Cable Connectors

- Current rating: 1 amp
- Insulation material: glass-filled polyester
- Temp range: -55°C to +120°C
- Contact material: phosphor bronze
- Terminates with standard D-type connectors
- Shell: MD: Metal; CD: Plastic (see mfr. cross ref. no.)



Part No.	Mfr. Cross Ref. No.	Cont.	Gender	1	10	100
109225CD	MDB9P†	9	M	..135	1.25	1.09
12503CD	CDB9P	9	M	2.49	1.79	1.59
109217CD	MDB9S†	9	F	1.49	1.19	1.05
12520CD	CDB9S	9	F	2.59	2.35	2.09
117381CD	MDA15P	15	M	1.55	1.25	.69
12298CD	CDA15P	15	M	1.55	1.25	.75
116011CD	MDA15S	15	F	1.55	1.25	.85
12319CD	CDA15S	15	F	1.69	1.35	.79
115983CD	MDB25P	25	M	1.85	1.69	1.45
12335CD	CDB25P	25	M	1.89	1.69	1.29
115975CD	MDB25S	25	F	1.85	1.65	1.39
12431CD	CDB25S	25	F	1.95	1.79	1.39
115991CD	MDC37P	37	M	2.39	2.15	1.55
12466CD	CDC37P	37	M	3.09	2.65	1.99
116003CD	MDC37S	37	F	2.95	2.69	2.42
12482CD	CDC37S	37	F	3.49	2.99	2.25

† Require flat cable w/ .0625" centers

Solder-Cup Connectors



Part No.	Contacts	Gender	1	10	100	1000
15114CD Front						
15114CD Back						
15747CD	9	M	..56	\$.44	\$.36	\$.24
15771CD	9	F	..59	.49	.44	.31
15077CD	15HD*	M	..69	.59	.49	.31
164822CD	15HD*	F	..79	.69	.59	.39
15034CD	15	M	..55	.49	.42	.29
15051CD	15	F	..59	.49	.39	.24
15114CD	25	M	..99	.89	.79	.71
15157CD	25	F	..89	.80	.69	.61
203799CD	26HD*	M	..65	.58	.52	.52
203781CD	26HD*	F	..65	.58	.52	.52
15472CD	37	M	..99	.85	.79	.49
15499CD	37	F	1.19	1.05	.85	.49
15675CD	50	M	1.65	1.49	1.35	.99
15691CD	50	F	1.79	1.39	1.32	1.19

* High Density

Straight PC Mount Connectors

- Non-removable contacts
- 125 Vrms
- Current rating: 5 amps
- Operating temperature: -65°F to +250°F
- Shell: Metal



Part No.	Mfr. Cross Ref. No.	Cont.	Gender	1	10	100
111691CD	DB9PPCB	9	M	..55	\$.45	\$.32
15780CD	DB9SPCB	9	F	..55	.45	.32
176760CD	DA15PPCB	15	M	..49	.39	.27
176751CD	DA15SPCB	15	F	..49	.44	.39
15122CD	DB25PPCB	25	M	..65	.59	.42
15165CD	DB25PCB	25	F	..74	.55	.31
180021CD	DC37PCB	37	F	..85	.72	.54

Crimp-Type Connectors and Pins

- Connectors: metal shell; removable male/female crimp pins
- Male/female pins: gold plated contact; tinned crimp tail
- Insertion/extraction tool: exchangeable tips
- Use 99442CD, pg 164 to crimp 43377CD, 43369CD



Part No.	Description	1	10	100	1000
73189CD	DB9 M housing	\$.49	\$.39	\$.31	\$.19
73197CD	DB9 F housing49	.39	.31	.19
73200CD	DA15 M housing59	.53	.48	.43
73218CD	DA15 F housing65	.59	.53	.47
180881CD	HDDB15 M housing* ..	1.09	.98	.78	.58
180890CD	HDDB15 F housing* ..	.89	.79	.72	.65
38789CD	DB25 M housing56	.44	.36	.21
38771CD	DB25 F housing55	.44	.31	.21
43377CD	M crimp pin	* .10	.09	.08	
43369CD	F crimp pin	* .08	.07	.06	
185421CD	M crimp pin (180881CD) *	.055	.045	.04	
185412CD	F crimp pin (180890CD) *	.055	.05	.04	
19094CD	Insertion/extraction tool for above pins (HT101)	3.49	2.99	2.59	2.59

* High Density

DIN and Mini DIN Plugs and Receptacles



- Solder barrels including strain relief
- See page 121 for cable

Part No.	Pins	Type	1	10	100
142279CD	4	Mini plug	\$.89	\$.79	\$.59
142261CD	6	Mini plug	.99	.85	.69
177244CD	6	Mini receptacle	.99	.85	.69
111878CD	8	Mini plug	.99	.89	.74
177236CD	8	Mini receptacle	1.09	.93	.69
15878CD	5	DIN plug	.55	.47	.35
180873CD	5	DIN receptacle	.59	.49	.45
15886CD	6	DIN plug	.59	.50	.39
15894CD	8	DIN plug	.69	.59	.49

DIN Female Sockets

- Metal body
- Panel mount with solder lugs



Part No.	Mfr. Cross Ref. No.	# of pins	1	10	100	500
15843CD	DINJ5	5	\$1.29	\$1.15	\$1.05	\$.79
15851CD	DINJ6	6	1.39	1.25	1.15	.99
15860CD	DINJ8	8	1.49	1.35	1.15	1.05

Right Angle DIN Female Sockets

- Set back: 0.5"
- PC mount contacts

140791CD/119474CD:

Plastic/metal body

29399CD: Plastic body

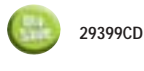

Part No.	Mfr. Cross Ref. No.	# of pins	1	10	100	500
140791CD	MDR4S	4 (mini)	\$.75	\$.66	\$.51	\$.40
119474CD	MDR6S	6 (mini)	.75	.68	.54	.40
207722CD	MDS8100	8 (mini)	.99	.89	.79	.69
29399CD	RD5	5	.59	.53	.40	.36

PCB Right Angle Centronics Connectors



- Solder-type contacts
- Space between rows: .164"
- Space between pins: 0.1"
- Metal body
- PC mount

Part No.	Description	1	10	100
72151CD	36-contact female	\$.35	\$3.19	\$2.87
72080CD	50-contact female	4.95	4.45	3.99

IDC Centronics Connector

- Contact material: gold plated phosphor bronze; plastic casing
- Current rating: 1 amp
- Temp. rating: -55°C to +105°C
- Use 73251CD IDC crimping tool, pg 164



Part No.	Mfr. Cross Ref. No.	Description	1	10	100
13848CD	CEN36M	36-contact male	\$1.75	\$1.55	\$1.39

SCSI-III Half-Pitch IDC Connector

- Connectors are high-density D-sub

SALE

Part No.	Description	1	10	50
139061CD	68-pin male SCSI-III	\$2.15	\$1.95	\$1.75

.100" IDC Plug Connectors

Double Row

- .100" x .100" grid
- Plastic
- Shrouded header w/o mounting ears
- Contact: gold-plated phosphor bronze
- Use with IDC socket for connectors, right



Part No.	Cross Ref. No.	Contacts	1	10	100
29188CD	P40	40	\$1.95	\$1.75	\$1.49
29217CD	P50	50	1.95	1.75	1.49

.100" Low-Profile Male Shrouded Headers

- Rating: 1A (max.) @ 250VDC
- Contact resistance: 15mΩ max.
- Features: UL recognized, CSA certified; .025" square post mates with sockets on .100" x .100" grid
- Contact: phosphor bronze, gold plated
- Use with IDC socket connectors, above

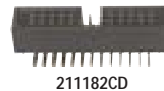

Straight Male Headers

Part No.	Description	1	10	100	1000
67811CD	10-pin	\$.39	\$.35	\$.32	\$.28
68179CD	16-pin	.44	.40	.35	.32
68291CD	20-pin	.49	.47	.39	.23
68371CD	26-pin	.54	.42	.35	.21
68582CD	34-pin	.79	.65	.46	.31
181104CD	40-pin	.75	.60	.45	.315

Right Angle Male Header

Part No.	Description	1	10	100	1000
211182CD	26-pin	\$.45	\$.40	\$.37	\$.35

.100" (2.5mm) Female Header Receptacles

- Gold plated contacts
- 0.1" contact center

Vertical Mount (Top Entry)

Part No.	Contacts	Type	1	10	100	500
70754CD	8	Single row	\$.59	\$.53	\$.43	\$.35
200782CD	12	Single row	.79	.59	.45	.42
70720CD	16	Double row	.89	.79	.72	.65
70826CD	20	Double row	.99	.87	.76	.61
105056CD	30	Double row	1.09	.99	.89	.68
163862CD	34	Double row	1.19	1.05	.92	.79
111704CD	40	Double (Tin)	1.29	1.15	.99	.89

Right Angle Mount (Side Entry)

Part No.	Contacts	Type	1	10	100	500
71159CD	20	Double row	\$1.25	\$1.10	\$.99	\$.85

Centronics Parallel Interface Connectors

Metal Body and Shell, Solder-Type Contacts

SALE



- Solder eyelets accept 24 AWG wire, pg 121
- Male cable plugs
- Complete with cable boot, shell and hardware

Part No.	Cross Ref. No.	Contacts	1	10	50
180072CD	57-30140	14	\$1.15	\$1.05	\$.95
42382CD	57-30360	36	1.79	1.59	1.49

.100" & 2mm IDC Socket Connectors

Double Row

- Mates with 2 rows of .025" Sq. or Dia. posts on patterns of .100" centers (male headers, see below)
- Industry standard IDC socket (plastic)
- Temperature rating: -55°C to +105°C
- Use crimping P/N 73251CD, pg 164



Polarized IDC Socket Connectors

Part No.	Mfr. Cross Ref. No.	Contacts	1	10	100	1000
32491CD	S10	10	\$.29	\$.25	\$.19	\$.15
153947CD	S14	14	.32	.27	.21	.16
119466CD	S16	16	.35	.29	.22	.17
32521CD	S20	20	.39	.32	.25	.18
32563CD	S26	26	.45	.35	.29	.19
32643CD	S34	34	.49	.39	.35	.25
32678CD	S40	40	.55	.45	.39	.29
100386CD	IDC440*	44 (2mm)	.99	.89	.75	.59
32707CD	S50	50	.65	.55	.45	.35
32758CD	S60	60	.75	.68	.54	.40

*2mm pin spacing

Non-Polarized IDC Socket Connectors

Part No.	Mfr. Cross Ref. No.	Contacts	1	10	100	1000
138376CD	SN10	10	\$.35	\$.32	\$.28	\$.24
138325CD	SN20	20	.45	.40	.36	.28
138333CD	SN26	26	.39	.35	.32	.28
138341CD	SN34	34	.45	.39	.35	.29
138350CD	SN40	40	.49	.45	.39	.29
138368CD	SN50	50	.65	.55	.45	.35

.100" (2.5mm) Straight Male Headers

With Standard Latch



Double Row

- 0.1" contact center
- Mount vertical
- Keying slot
- Use with IDC socket connectors, above

Part No.	Description	1	10	100	500
117663CD	10-pin	\$1.29	\$1.09	\$.81	\$.58
71829CD	20-pin	1.39	1.25	1.13	.95
71933CD	26-pin	1.49	1.25	.99	.89
72215CD	50-pin	1.85	1.65	1.49	1.35

PANAVISE IDC Bench Press and Cable Cutter

Designed for low to medium volume mass termination of various IDC connectors on flat ribbon cable.



Part No.	Prod. No.	Description	Wt. (lbs.)	1	10
27174CD	M505	Bench press	7.0	\$179.95	\$159.95

M505 Accessories

27182CD	M507	Cable cutter	0.9	\$66.95	\$61.95
27203CD	M510	Base plate	0.5	26.95	24.29

Jameco's Low-Price Guarantee

We'll match the advertised price of any like product.

.100" Non-Polarized Connector Housings and Crimp Pins

- Mates with .025" square post on pattern of .100" centers (male headers, see pg 128)
- Current rating: 1A • Pin material: brass/tin plated
- Pin wire gauge: 26-22 AWG • Plastic
- Temperature rating: -55°C to +105°C
- Use 159265CD pin crimper, pg 164 and 100765CD below

* Prepackaged: order in increments of 10, 100 or 1000

		Single Row			
		103190CD			
		100765CD			
Part No.	Mfr. Cross Ref. No.	Contacts	1	10	100 1000
100811CD	SCH2	2 *	\$.23	\$.21 \$.17
157382CD	SCH3	3 *	.24	.22 .18
100802CD	SCH4	4 *	.25	.23 .19
163686CD	SCH5	5 *	.27	.25 .22
103211CD	SCH6	6 *	.31	.27 .21
103202CD	SCH8	8 *	.35	.29 .25
103190CD	SCH10	10 *	.42	.39 .31
103181CD	SCH20	20 *	.49	.45 .35
103157CD	SCH36	36 *	.49	.45 .35
100765CD	FCH1	Female pin *	.11	.09 .06
145357CD	MCH1	Male pin *	.15	.135 .12

		Double Row			
		145357CD			
		103253CD			
Part No.	Mfr. Cross Ref. No.	Contacts	1	10	100 1000
103253CD	DCH8	8 *	\$.59	\$.53 \$.45 \$.39
157420CD	DCH10	10 *	.69	.62 .55 .49
157438CD	DCH14	14 *	.79	.69 .62 .55
103237CD	DCH16	16 *	.83	.75 .60 .45
103229CD	DCH20	20 *	.99	.89 .79 .69
157462CD	DCH40	40 *	1.09	.99 .89 .75
157471CD	DCH50	50 *	.65	.59 .53 .47
100765CD	FCH1	Female pin *	.11	.09 .06
145357CD	MCH1	Male pin *	.15	.135 .12

.100" Low Profile Keyed Shrouded Headers and Connector

CD-ROM 4-Pin Headers and Connector



- Voltage rating: 250V AC/DC
- Current rating: 3A AC/DC
- Insulation resistance: 1000MΩ min.
- Connector material: PBT, 30% glass
- Header material: PBT + 30% glass
- Withstanding voltage: 1000V AC/minute
- Pin material: tin-plated brass
- Recommended crimp tool P/N 99442CD, pg 164

* Prepackaged: order in increments of 10, 100 or 1000

Part No.	Description	1	10	100	1000
152741CD	Straight header	\$.45	\$.39	\$.35 \$.29
152725CD	Right angle header55	.49	.45 .39
152733CD	Single w/ latch†45	.39	.23 .17
181673CD	Female pins *	.11	.08	.06

† P/N 152733CD requires 4 pins (P/N 181673CD)

.100" DIP Header Plugs

- Gold-plated leads
- Header plugs: keyed corner to indicate pin 1
- U-shaped pin termination for easy component attachment
- Lead length: .188" • 0.1" spacing between leads

Part No.	Mfr. Cross Ref. No.	Width	Pins	1	10	100
104336CD	8HP	0.3"	8	\$.79	\$.67 \$.57
134922CD	14THP*	0.3"	1499	.85 .69
37129CD	14HP	0.3"	14	1.19	.99 .89
37330CD	16HP	0.3"	16	1.35	1.25 1.09
38578CD	20HP	0.3"	20	1.49	1.35 1.19

* 134922CD is tin-plated

.100" IDC DIP Flat Cable Plugs

- Mates with standard 14, 16, 20, 24, 26, 28 & 40-pin DIP sockets with 0.1" spacing
- Plastic with gold-plated contacts
- Uses 28 AWG flat ribbon cable, pg 121
- Current rating: 1 amp

Part No.	Mfr. Cross Ref. No.	Width	Contacts	1	10	100	500
42657CD	609-14	0.3"	14	\$.49	\$.40	\$.35 \$.29
42673CD	609-16	0.3"	1655	.45	.35 .30
104096CD	609-20	0.3"	2069	.62	.55 .49
42690CD	609-24	0.6"	2479	.71	.64 .59
99670CD	609-28	0.6"	2889	.80	.72 .59
42711CD	609-40	0.6"	40	1.15	1.05	.95 .85

Card-Edge Connectors

- Fits all PC boards • .054" to .070" thick
- **Solder Eyelet .140" Spacing Between Rows**
- Contact centers: .156" • With mounting ears

Part No.	Position	Contacts	1	10	100
39116CD	22/44	Gold	\$2.95	\$2.65 \$2.38

Solder Tail .200" Spacing Between Rows

Part No.	Position	Contacts	1	10	100
40694CD	31/62	Tin (PC/AT)	\$.99	\$.89 \$.69
42091CD	49/98	Tin (AT)89	.59 .39

Fiber Optic Infrared Detectors

- Mates with standard 1000µm core jacketed plastic fiber cable
- Connector-less fiber termination and connection
- Inexpensive plastic connector housing
- Compatible with LED emitters, below
- Interference-free transmission from light-tight housing
- Internal micro-lens for efficient coupling



- Internal micro-lens for efficient coupling
- **169990CD:** TTL compatible output infrared detector D95T
- **169981CD:** TTL open-collector output infrared detector D96

Part No.	Color Dot	Peak Wavelength	Sensitivity	1	10
169990CD	Yellow	800nm	\$5.95	\$5.35
169981CD	White	850nm	6.95	6.25

Infrared and Visible Light Fiber Optic LED Emitters

- Mates with standard 1000µm core jacketed plastic fiber cable (recommend P/N 171272CD, below)
- Internal micro-lens for efficient coupling
- Connector-less fiber termination and connection
- Interference-free transmission from light-tight housing
- Excellent linearity
- Compatible with fiber optic photo detectors, above



Peak Wavelength Sensitivity:

- **169957CD:** 950nm, Vf=1.7V max @ 50mA
- **169965CD:** 660nm, Vf=1.8V max @ 50mA
- **169949CD:** 660nm, Vf=1.8V max @ 50mA

Part No.	Description	Color Dot	1	10
169957CD	Fiber optic LED E91A	Blue	\$3.25 \$2.95
169965CD	Fiber optic LED E96	Pink	5.35 4.89
169949CD	Fiber optic LED E97	Red	5.95 5.39

USB-A & B Connectors and Pins



174060CD: USB A & B Male Connector

- 3-part housing: tin plate over brass and glass fiber
- 4-pins (P/N 159724CD) required per USB connector

161023CD/174051CD: USB A & B Female Connectors

- PC mount right angle with board locks

159724CD: Male Crimp Pin

- Pin for P/N 174060CD (4 required)
- Contact brass
- Use P/N 159265CD for crimping tool, pg 164

* Prepackaged: order in increments of 10, 100 or 1000

Part No.	Description	1	10	100	1000
161023CD	USB-A conn. (F)	\$.79	\$.71	\$.61 \$.55
174060CD	USB-B conn. (M)95	.85	.69 .55
174051CD	USB-B conn. (F)95	.85	.69 .55
159724CD	Crimp pin *	.125	.09	.065

Fiber Optic Cable-Cutting Tool Kit

- Contains fiber optic stripper, 25W hot knife professional fiber cutter, water dispenser, rubber pad, 600 grit and 3µm polishing film, replacement blades, ST-connector fiber polishing puck, rugged storage container and instructions.



Part No.	Description	Wt. (lbs.)	1	10
170034CD	Fiber Optic Tool Kit	2.5	\$105.95 \$94.95

10' Fiber Optic Cable

- 1000µm core jacketed plastic fiber optic cable (10')

Part No.	Description	1	10
171272CD	10' fiber optic cable	\$6.95 \$6.25

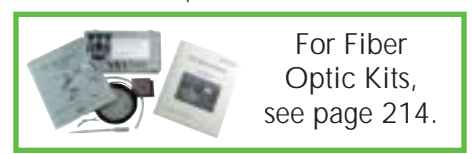

For Fiber Optic Kits, see page 214.

Machine Contact Dual-In-Line Female Sockets

- 0.100" centers
- Solder tail contact: .114" L
- Pin sleeve: tin
- Contact clip: gold

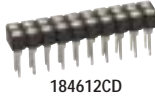

Part No.	Mfr. Cross Ref. No.	Pins	1	10	100
212855CD	SA101000	10	\$.29	\$.23	\$.21
212863CD	SA121000	12	.30	.28	.25
212871CD	SA141000	14	.35	.33	.30
212880CD	SA161000	16	.40	.37	.34
212898CD	SA181000	18	.45	.42	.38
184612CD	SA201000	20	.50	.46	.42
212901CD	SA221000	22	.55	.51	.47
212919CD	SA241000	24	.60	.56	.51
212927CD	SA321000	32	.80	.74	.68
212935CD	SA481000	48	1.20	1.11	1.01

ARIES® Low Profile ZIF Sockets

Provides a low cost solution for ZIF test socket requirements. It has a height of only .319" (8.10mm), and even with the handle in open position it measures just .554" (14.07mm).

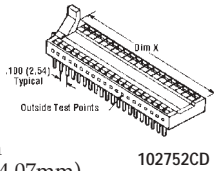

Part No.	Aries No.	Pins	Dim X	1	10	100
102744CD	28-526	28	1.64"	\$5.49	\$4.99	\$4.49
102752CD	40-526	40	2.24"	6.95	6.39	5.75

ARIES® Universal ZIF Sockets

- Solder directly to PCB or plug directly into IC socket
- Screw mounting holes
- Accepts .300" to .600" IC centers x .1" spacing



Part No.	Aries No.	Pins	1	10	100
103991CD	24-6554-10	24	\$7.49	\$6.79	\$5.99
104002CD	28-6554-10	28	8.45	7.39	7.15
104011CD	32-6554-10	32	9.95	8.49	8.29
104029CD	40-6554-10	40	11.25	9.80	9.45

Jameco Special Values!



See the yellow and green highlighted items.

Details on page 4.



For Tools see pages 160 - 168.

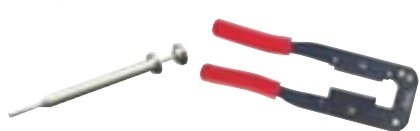

.100" Male Headers (Gold)

- Solder to PC boards for instant plug-in access via shorting blocks, pg 128
- Snap apart to fit your application
- Contact material: phosphor bronze
- Current rating: 1 amp
- Contact area: gold
- Temp. range: -55°C to +120°C
- .025" square posts on a .100" x .100" matrix
- Use with crimp connector housing, pg 127

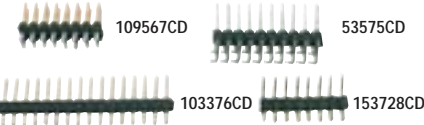

*Prepackaged: order in increments of 10, 100 or 1000

.100" Straight Male Headers Single Row

Part No.	Mfr. Cross Ref. No.	Contacts	1	10	100	1000
108337CD	SMH02	2	\$.16	\$.14	\$.13	
109575CD	SMH03	3	.17	.15	.135	
117559CD	SMH04	4	.17	.15	.135	
153699CD	SMH06	6	.17	.15	.135	
153701CD	SMH08	8	.20	.17	.15	
103392CD	SMH10	10	.18	.14	.10	
103376CD	SMH17	17	.16	.14	.13	
103368CD	SMH20	20	.25	.23	.21	
202825CD	SMH22	22	*.25	*.21	*.16	
103350CD	SMH25	25	.25	.21	.16	
103341CD	SMH30	30	.35	.31	.28	.25
68339CD	SMH36	36	.42	.38	.34	.29
160881CD	SMH40	40	.49	.44	.40	.36

.100" Straight Male Headers Double Row

Part No.	Mfr. Cross Ref. No.	Contacts	1	10	100	1000
115027CD	923804DS	4	\$.10	\$.09	\$.07	
115035CD	923806DS	6	.18	.16	.14	
109516CD	923808DS	8	.18	.16	.14	
67820CD	923810DS	10	.18	.16	.14	
203810CD	923812DS	12	.60	.55	.49	.44
118455CD	923814DS	14	.45	.40	.36	.33
109567CD	923816DS	16	.55	.49	.45	.39
203828CD	923818DS	18	.65	.59	.55	.49
53479CD	923822DS	22	.70	.65	.59	.49
203836CD	923824DS	24	.70	.65	.59	.49
203844CD	923826DS	26	.70	.65	.59	.49
53495CD	923830DS	30	.75	.69	.59	.55
203852CD	923832DS	32	.75	.69	.59	.55
203879CD	923834DS	34	.75	.69	.59	.55
203861CD	923836DS	36	.80	.75	.65	.59
53516CD	923838DS	38	.80	.75	.65	.59
53532CD	923840DS	40	.65	.55	.39	.25
53559CD	923842DS	42	.60	.55	.49	.45
68574CD	923844DS	44	.70	.65	.59	.55
103405CD	923846DS	46	.85	.75	.69	.59
117196CD	923848DS	48	.90	.80	.75	.65

.100" Shorting Block w/ Handle

- Mates w/ .100" male headers, pg 128
- Ratings:
 - Current: 3A
 - Accessible test point in handle
- Contact resistance: 20mΩ max.

Material:

- Plastic: PBT, glass filled
- Contact: phosphor bronze
- Prepackaged: order in increments of 10, 100 or 1000

Part No.	Description	10	100	1000
152670CD	.100" shorting block	\$.19	\$.15	\$.12



.100" Right Angle Male Headers Single Row

Part No.	Mfr. Cross Ref. No.	Contacts	1	10	100	1000
153728CD	RMH08	8	\$.45	\$.40	\$.30	\$.25
103270CD	RMH36	36	.75	.64	.58	.41

.100" Right Angle Male Headers Double Row

Part No.	Mfr. Cross Ref. No.	Contacts	1	10	100	1000
203908CD	923804DR	4	\$.49	\$.44	\$.40	\$.36
203916CD	923806DR	6	.55	.49	.33	.26
203924CD	923808DR	8	.49	.44	.35	.26
203932CD	923810DR	10	.59	.53	.40	.31
203941CD	923812DR	12	.59	.53	.42	.31
203959CD	923814DR	14	.65	.58	.47	.34
203967CD	923816DR	16	.65	.58	.47	.34
203975CD	923818DR	18	.65	.58	.47	.34
53575CD	923820DR	20	.59	.53	.48	.43
203983CD	923822DR	22	.65	.58	.47	.34
203991CD	923824DR	24	.65	.58	.47	.34
53583CD	923826DR	26	.69	.55	.41	.29
204003CD	923828DR	28	.69	.62	.50	.36
204011CD	923830DR	30	.75	.68	.54	.40
204020CD	923832DR	32	.75	.68	.54	.40
204038CD	923834DR	34	.75	.68	.54	.40
204046CD	923836DR	36	.75	.68	.54	.40
204054CD	923838DR	38	.75	.68	.54	.40
53604CD	923840DR	40	.85	.75	.57	.50
53612CD	923850DR	50	.85	.75	.57	.50
103413CD	923872DR	72	1.15	.99	.89	.75
139563CD	923880DR	80	1.35	1.19	1.09	.99

.100" and 2mm Shorting Blocks

- Mates to .025" square posts on .100" centers
 - Shorting socket jumper to address or code strip line plugs
 - Mate with male headers, pg 128
 - Pin material: phosphor bronze
- Open:** open on top to allow for a test point while they are the same
- 119263CD:** 2mm shorting block (for disk drives)



Part No.	Description	10	100	1000
22023CD	Top open, black	\$.12	\$.09	\$.06
119263CD	Top open, black (2mm)	.15	.135	.12
112424CD	Top open, blue	.12	.09	.06
112416CD	Top open, red	.12	.09	.06
19140CD	Top closed, black	.12	.09	.06
112441CD	Top closed, blue	.12	.09	.06
112432CD	Top closed, red	.16	.14	.11

Solder Tail Low Profile Sockets

- Material: beryllium copper or phosphor bronze
- Contact current: 1A
- Tin-plated contacts and tails
- Contact resistance: less than 5mΩ
- Dielectric withstanding voltage: 300Vrms
- Insulation resistance: greater than 1000MΩ
- Insulator: glass-filled polyester or glass-filled polyphenylene sulfide
- Sleeve material: brass
- Thru-hole lead length: .140" (A)
- Body height: .188" (B)

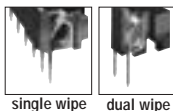
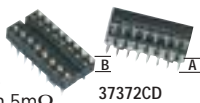

Single Wipe

- Prepackaged: order in increments of 10, 100 or 1000

Part No.	Mfr. Cross Ref. No.	Pins	Width (in.)	10	100	1000
51570CD	8LP	8	0.3 ...	\$.07	\$.06	\$.05
37161CD	14LP	14	0.309	.07	.06
37372CD	16LP	16	0.310	.09	.06
38113CD	18LP	18	0.311	.094	.07
38607CD	20LP	20	0.312	.10	.07
39132CD	22LP	22	0.412	.10	.07
39378CD	24SLP	24	0.317	.12	.06
39335CD	24LP	24	0.616	.14	.09
40301CD	28LP	28	0.619	.13	.09
41110CD	40LP	40	0.619	.17	.12

Dual Wipe

- Prepackaged: order in increments of 10, 100 or 1000

Part No.	Mfr. Cross Ref. No.	Pins	Width (in.)	10	100	1000
112192CD	6LPD	6	0.3 ...	\$.09	\$.06	\$.05
112205CD	8LPD	8	0.309	.08	.07
112213CD	14LPD	14	0.310	.075	.05
112221CD	16LPD	16	0.313	.115	.095
112230CD	18LPD	18	0.316	.14	.12
112248CD	20LPD	20	0.317	.14	.11
112281CD	24SLPD	24	0.317	.14	.11
112264CD	24LPD	24	0.619	.16	.12
112299CD	28SLPD	28	0.321	.19	.17
112272CD	28LPD	28	0.621	.17	.12
112301CD	32LPD	32	0.618	.14	.10
112310CD	40LPD	40	0.626	.23	.19
167396CD	48LPD	48	0.635	.32	.29
112326CD	64LPD	64	0.939	.33	.24

SIMM and SIPP Sockets

- Locking tabs
- Tinned contacts
- Memory module sockets
- Keyed mounting posts

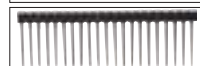
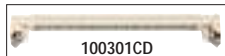

SIMM Sockets

Part No.	Description	1	10	100	500
100301CD	Single x 30-pin, vert.	\$.99	\$.89	\$.69	\$.59
72531CD	Dual x 30-pin, vert.	.25	.15	.12	.09
203203CD	Single x 68-pin vert.	.89	.75	.59	.49
72426CD	Single x 72-pin vert.	1.10	.99	.79	.58

SIPP Sockets

Part No.	Description	1	10	100	500
102200CD	Single x 10-pin	\$.26	\$.23	\$.20	\$.18
192840CD	Single x 11-pin	.49	.44	.35	.26
78641CD	Single x 30-pin	.89	.80	.68	.61
175919CD	Single x 36-pin	1.19	1.09	.97	.87
101282CD	Single x 20-pin WW2†	1.49	1.35	1.09	.80
104053CD	Single x 30-pin WW3*	1.95	1.75	1.49	1.35

† Lead length: .435" (2) * Lead length: .575" (3)

Machine Tooled Solder Tail Low Profile Sockets

- Contact plating: gold
- Tin-plated leads
- Contact current: 3A
- Multiple contact elements
- Material: beryllium copper or phosphor bronze
- Contact resistance: less than 5mΩ
- Dielectric withstanding voltage: 300Vrms
- Insulation resistance: greater than 1000MΩ
- Insulator: glass-filled polyester or glass-filled polyphenylene sulfide
- Sleeve material: brass
- Thru-hole lead length: .177" (A)
- Body height: .117" (B)

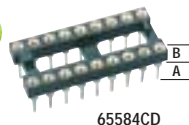

Part No.	Mfr. Cross Ref. No.	Pins	Width (in.)	1	10	100	1000
167003CD	6MLPT	6	0.3 ...	\$.29	\$.26	\$.18	\$.16
51625CD	8MLP	8	0.325	.22	.19	.17
37196CD	14MLP	14	0.342	.38	.33	.30
37401CD	16MLP	16	0.347	.43	.37	.34
65584CD	18MLP	18	0.355	.49	.43	.39
38623CD	20MLP	20	0.359	.55	.45	.39
192209CD	22ASMLP	22	0.459	.53	.42	.31
39386CD	24SMLP	24	0.371	.64	.51	.38
39351CD	24MLP	24	0.672	.65	.52	.39
114411CD	28SMLP	28	0.385	.75	.65	.55
184680CD	284SMLP	28	0.485	.75	.65	.55
40328CD	28MLP	28	0.683	.75	.65	.59
105380CD	32MLP	32	0.695	.85	.75	.65
41136CD	40MLP	40	0.6 ...	1.19	1.05	.79	.69
42059CD	48MLP	48	0.6 ...	1.39	1.25	1.05	.72
200707CD	64MLP	64	0.9 ...	1.89	1.69	1.53	1.37

Wire Wrap Socket I.D. Markers

- Quick identification of pin numbers
- Slips onto socket before wrapping
- Plastic
- Can easily write location, part number or function

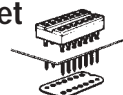

Part No.	Prod. No.	Pins	Width (in.)	1	10	100	500
51561CD	8ID	8	0.3 ...	\$.44	\$.35	\$.30	\$.28
37145CD	14ID	14	0.335	.31	.28	.24
37356CD	16ID	16	0.329	.25	.23	.21
38105CD	18ID	18	0.349	.45	.39	.35
38586CD	20ID	20	0.355	.49	.39	.35
39327CD	24ID	24	0.659	.52	.43	.38
40299CD	28ID	28	0.665	.55	.45	.41
41101CD	40ID	40	0.689	.79	.69	.65

PLCC Solder Tail Sockets

- Solder tail allows through-hole board patterns in .100" grid
- Accepts JEDEC type "A" plastic leaded chip (0.05" centers)
- Thru-hole lead length: .125"
- Body height: .375"



Part No.	Mfr. Cross Ref. No.	Pins	1	10	50	100
71263CD	G1P428	28	\$.56	\$.44	\$.34	\$.29
71811CD	G1P432	32	1.15	.99	.81	.54
71618CD	G1P444	44	1.15	.99	.81	.69
72442CD	G1P452	52	1.15	.91	.75	.63
71968CD	G1P468	68	1.15	.99	.89	.79
71976CD	G1P484	84	1.29	1.19	.93	.70



See page 85 for PLCC Surface Mount Sockets.

Level 1, 2 & 3 Wire Wrap Sockets

- Contact plating/leads: gold (WWW) or tin (TWW); Dual Wipe
- Material: beryllium copper or phosphor bronze
- Contact current: 1A
- Contact resistance: less than 5mΩ
- Dielectric withstanding voltage: 300Vrms
- Insulation resistance: greater than 1000MΩ
- Insulator: glass-filled polyester or glass-filled polyphenylene sulfide
- Sleeve material: brass
- Thru-hole lead length: .315" (L1); .438" (L2); .638" (L3)
- Body height: .300" (A)

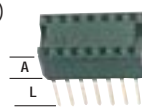

Gold (WWW)

SALE

Part No.	Mfr. Cross Ref. No.	Pins	Width (in.)	1	10	100	500
51641CD	8WWW2	8	0.3	\$1.49	\$1.29	\$1.19	\$.99
196832CD	14WWW1	14	0.3	1.19	1.07	.86	.64
37233CD	14WWW2	14	0.3	1.49	1.35	1.19	1.09
37479CD	16WWW2	16	0.3	1.75	1.59	1.43	1.29
196859CD	18WWW3	18	0.3	1.55	1.39	1.12	.84
38674CD	20WWW2	20	0.3	2.25	1.99	1.82	1.65
39394CD	24WWW2	24	0.6	1.95	1.73	1.51	1.40
40352CD	28WWW2	28	0.6	2.35	2.07	1.81	1.69
41187CD	40WWW2	40	0.6	3.15	2.80	2.45	2.29

Tin (TWW)

Part No.	Mfr. Cross Ref. No.	Pins	Width (in.)	1	10	100	500
112660CD	8TWW2	8	0.3	\$.49	\$.45	\$.38	\$.34
37217CD	14TWW2	14	0.3	1.15	1.03	.93	.84
196841CD	14TWW3	14	0.3	.93	.79	.65	.49
37436CD	16TWW2	16	0.3	.99	.89	.73	.66
87636CD	18TWW2	18	0.3	1.09	.98	.81	.73
75379CD	20TWW2	20	0.3	1.69	1.52	1.35	1.23
75416CD	24TWW2	24	0.6	1.49	1.35	1.09	.79
75424CD	28TWW2	28	0.6	2.19	1.95	1.79	1.59
41179CD	40TWW2	40	0.6	2.59	2.22	1.85	1.69

Level 2 & 3 Machine Tooled Wire Wrap Sockets

- Contact plating: gold
- Tin-plated leads
- Contact current: 3A
- Contact resistance: less than 5mΩ
- Dielectric withstanding voltage: 300Vrms
- Material: beryllium copper or phosphor bronze
- Insulation resistance: greater than 1000MΩ
- Insulator: glass-filled polyester or glass-filled polyphenylene sulfide
- Sleeve material: brass
- Body height: .115" (A)
- Thru-hole lead length: .365" (L2); .515" (L3)

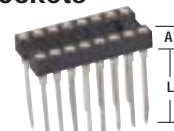

Part No.	Mfr. Cross Ref. No.	Pins	Width (in.)	1	10	100	500
94473CD	8MSWW3	8	0.3	\$.53	\$.46	\$.38	\$.34
62050CD	14MSWW3	14	0.3	.93	.80	.67	.60
37410CD	16MSWW3	16	0.3	1.09	.93	.78	.69
94481CD	18MSWW3	18	0.3	1.15	.99	.81	.73
38631CD	20MSWW3	20	0.3	1.33	1.14	.95	.86
185324CD	22MSWW3	22	0.3	1.49	1.29	1.15	.99
192831CD	224MSWW3	22	0.4	1.45	1.25	.99	.78
105371CD	24MSWW3	24	0.3	1.60	1.39	1.19	1.03
196867CD	24MSWW2	24	0.6	1.49	1.35	1.15	.81
94490CD	24MSWW3	24	0.6	1.60	1.45	1.35	1.19
200715CD	283MSWW3	28	0.3	1.86	1.60	1.35	1.19
40336CD	28MSWW3	28	0.6	1.79	1.55	1.29	1.17
117057CD	32MSWW3	32	0.6	2.19	1.79	1.55	1.35
94502CD	40MSWW3	40	0.6	2.66	2.28	1.90	1.71
200723CD	48MSWW3	48	0.6	2.99	2.69	2.42	2.18
200731CD	64MSWW3	64	0.9	3.99	3.49	3.29	2.99

BNC Connectors and Adapters

- Frequency range: 0-4GHz
- Working voltage: 500V
- Contact plating: silver/gold
- Body plating: nickel/tin-lead
- Cable type:
- 223351CD: RG58/58A/58C/141/303/LMR, Belden 7806A
- 223360CD: RG55/141/142/223/400
- 223394CD: RG59/62/71/140/210/302
- 223474CD: RG59/62/140/210, Belden 8241/8263/8279/9209
- 223693CD: RG5/9/87A/214/313/325



Fig. 1



Fig. 2



Fig. 3



Fig. 4



Fig. 5



Fig. 6



Fig. 7



Fig. 8



Fig. 9



Fig. 10



Fig. 11



Fig. 12



Fig. 13



Fig. 14

Part No.	Product No.	Fig.	Industry No.	Description	1	10	100
223351CD	31-2	1	UG-88/U	50Ω plug, straight, clamp/solder	\$4.55	\$3.45	\$3.25
223431CD	31-202	1	UG-88C/U	50Ω plug, straight, solder cup	4.15	3.25	2.75
223360CD	31-5	2	UG-89/U	50Ω jack, straight, clamp/solder	5.99	4.55	3.39
223378CD	31-8	3	UG-274/U	50Ω/75Ω T-adapter, jack-plug-jack	12.59	9.49	7.45
223458CD	31-208	3	UG-274A/U	50Ω T-adapter, jack-plug-jack	10.49	7.99	5.85
223386CD	31-9	4	UG-306/U	50Ω right angle adapter, jack-plug	13.29	9.99	7.45
223466CD	31-209	4	UG-306A/U	50Ω right angle adapter, jack-plug	12.49	10.75	8.19
223394CD	31-12	5	UG-260/U	50Ω plug, straight, clamp	7.49	5.79	5.65
223474CD	31-212	5	UG-260B/U	50Ω plug, straight, clamp/solder	4.29	3.29	3.19
223415CD	31-17	6	CW-159/U	50Ω male shorting cap	7.59	5.75	3.89
223423CD	31-102	7	UG-657/U	50Ω bulkhead receptacle, straight, solder cup	6.15	4.49	4.10
223440CD	31-203	8	UG-290A/U	50Ω receptacle, straight/flange, solder cup	6.99	5.29	4.05
223482CD	31-218	9	UG-491A/U	50Ω in-series adapter, plug-plug	9.29	6.99	5.89
223491CD	31-219	10	UG-914/U	50Ω in-series adapter, jack-jack	5.39	3.99	2.99
223503CD	31-220H	11	UG-492A/U	50Ω in-series adapter, jack-jack	9.15	6.99	5.99
223511CD	31-221	12	UG-1094/U	50Ω bulkhead receptacle, straight, solder cup	2.55	1.95	1.43
223538CD	31-2221	13	UG-1094A/U	50Ω bulkhead receptacle, straight, solder cup	3.69	2.49	1.89
223520CD	31-236	12	UG-625B/U	50Ω bulkhead receptacle, straight, pin/pin	2.85	2.15	1.69
223685CD	5575	12	UG-625/U	50Ω bulkhead receptacle, solder	4.45	3.39	2.69
223693CD	6775	14	UG-959/U	50Ω right angle plug, clamp/solder	12.59	9.99	9.75

UHF Connectors and Adapters

- Frequency range: 0-300MHz
- Working voltage: 500V
- Contact plating: nickel & silver
- Cable type:
- 223600CD/223618CD/223677CD: RG8/9/87A/214/313/225
- 223651CD: RG58/141



Fig. 1



Fig. 2



Fig. 3



Fig. 4



Fig. 5



Fig. 6



Fig. 7



Fig. 8

Part No.	Product No.	Fig.	Industry No.	Description	1	10	100
223562CD	83-1AP	1	UG-646/U	In-series right angle adapter, jack-plug	\$7.15	\$6.49	\$6.05
223571CD	83-1F	2	UG-363/U	In-series bulkhead adapter, socket-socket	13.49	10.49	10.29
223589CD	83-1J	3	PL-258	In-series straight adapter, jack-jack	6.99	5.99	5.29
223837CD	83-1T	4	M-358	In-series T-adapter, jack-plug-jack	11.19	8.99	8.75
223597CD	83-1R	5	SO-239	Non-constant impedance panel receptacle, solder cup	3.10	2.49	2.29
223669CD	83-798	5	SO-239A	Non-constant impedance panel receptacle, solder cup	5.25	3.99	3.59
223600CD	83-1SP	6	PL-259	Non-constant impedance plug, straight, solder-solder	3.69	2.79	2.39
223618CD	83-1SP-1050	7	PL-259	Non-constant impedance plug, straight, solder-solder	2.29	1.85	1.55
223677CD	83-822	7	PL-259	Non-constant impedance plug, straight, solder-solder	3.89	2.99	2.59
223651CD	83-765	8	UG-177/U	Hood for 83-1R, above	2.55	1.99	1.69

BNC Adapters



188411CD



188429CD



188402CD

- Frequency range: 0-4GHz with low reflection
- 188411CD: Straight jack-to-jack
- 188429CD: Jack-plug-jack
- 188402CD: Gasketed jack-to-jack

Part No.	Product No.	1	10	50	100
188411CD	31-219-RFX	\$2.99	\$2.49	\$1.72	\$1.62
188429CD	31-208-RFX	4.69	3.99	2.99	2.39
188402CD	31-220G-RFX	3.49	3.15	2.79	2.49

BNC & Type N 50Ω Cable Plugs

BNC 3-Piece

- Silver-plated
- Frequency range: 0-4GHz with low reflection
- Attachment (outer/inner): crimp/crimp



- 188306CD: RG58/184
- 188349CD: RG174/188/316

Part No.	Product No.	1	10	50	100
188306CD	31-320-RFX	\$1.69	\$1.29	\$0.95	\$0.79
188349CD	31-315-RFX	1.99	1.79	1.35	1.05

Type N

- Silver-plated
- RG58/141
- Attachment (outer/inner): crimp/crimp



Part No.	Product No.	1	10	50	100
188445CD	82-5375-RFX	\$4.19	\$3.19	\$2.39	\$2.19

SMA Brass Plug

- Frequency range: 0-18GHz
- Outer cable attachment: crimp
- Inner cable attachment: solder
- Construction: captive contact
- Type: crimp plug
- For RG174/U, RG188/U, and RG316/U cables



Part No.	Product No.	1	10	50
188488CD	901-9877-RFX	\$2.49	\$2.25	\$1.99

RG Type Bulk Coaxial Cable



- RG58/U & RG58A/U (50Ω): nominal capacitance: 27pF/ft.; center resistance: 10.4Ω/1kft. @ 77°F
- RG59/U (75Ω): nominal capacitance: 19pF/ft.; center resistance: 16.5Ω/kft. @ 77°F
- RG174/U (50Ω): nominal capacitance: 30.8pF/ft.; center resistance: 97Ω/kft. @ 77°F

• Prepackaged and priced in increments of 100' or 1000'

Part No.	Description	100 ft.	1000 ft.
102226CD	RG58/U, for ethernet, oscilloscopes (solid 20 AWG)	\$12.00	\$96.00
116898CD	RG58A/U, for ethernet, oscilloscopes (stranded 20 AWG)	16.00	140.00
102218CD	RG59/U, for CATV & video patch cords (solid 22 AWG)	13.00	110.00
112037CD	RG174/U, for ethernet, oscilloscopes (stranded 26 AWG)	19.00	169.00

We carry major manufacturers – call for OEM PRICING.

BNC Coax Connectors **SALE**

• Miniature, lightweight units designed to operate up to 11GHz and typically yield low reflection up to 4GHz

Part No.	Fig.	Description	1	10	100	500
71458CD	1	BNC male terminator (50Ω)	\$1.55	\$1.15	\$.99	\$.89
71790CD	1	BNC male terminator (75Ω)	1.35	1.09	.89	.73
102306CD	1	BNC male terminator (93Ω)	.36	.33	.29	.26
135618CD	2	BNC male with pin and ferrule (RG6)	.89	.69	.45	.39
71482CD	2	BNC male with pin and ferrule (RG58)	1.65	1.49	1.35	1.25
71271CD	2	BNC male with pin and ferrule (RG59/62)	1.39	1.25	.99	.75
112109CD	2	BNC male with pin and ferrule (RG174)	1.59	1.45	1.29	1.15
119394CD	3	BNC male clamp-on (RG59/62)	1.39	1.25	1.15	.89
108994CD	4	BNC male twist-on (RG58)	1.49	1.19	.95	.75
71781CD	4	BNC male twist-on (RG59/62)	1.09	.99	.89	.79
71589CD	5	BNC female panel mount (UG-1094A)	1.49	1.35	1.25	1.09
71909CD	6	BNC female/female coupler (UG-914)	1.29	.99	.85	.74
127343CD	7	BNC male/male coupler (UG-491B/U)	1.69	1.55	1.39	1.25
111561CD	8	BNC female isolated bulkhead	2.29	1.99	1.79	1.59
148224CD	9	BNC female bulkhead feed-thru	1.69	1.55	1.39	1.25
148232CD	9	BNC female isolated bulkhead feed-thru	2.29	2.09	1.85	1.69
127351CD	10	BNC M-F right angle (DG-306B/O)	2.49	2.19	1.85	1.59
160928CD	11	BNC female, crimp type (RG58)	1.25	1.09	.99	.89
161921CD	11	BNC female, crimp type (RG174)	1.49	1.35	1.19	1.05
174289CD	12	BNC female chassis mount	1.29	1.09	.99	.89
174297CD	13	BNC female twist-on bulkhead	2.25	1.95	1.79	1.59
174254CD	14	BNC male to F connector female	1.69	1.55	1.39	1.25
207183CD	15	BNC male to RG58/59 crimp on	3.99	3.59	3.25	2.95

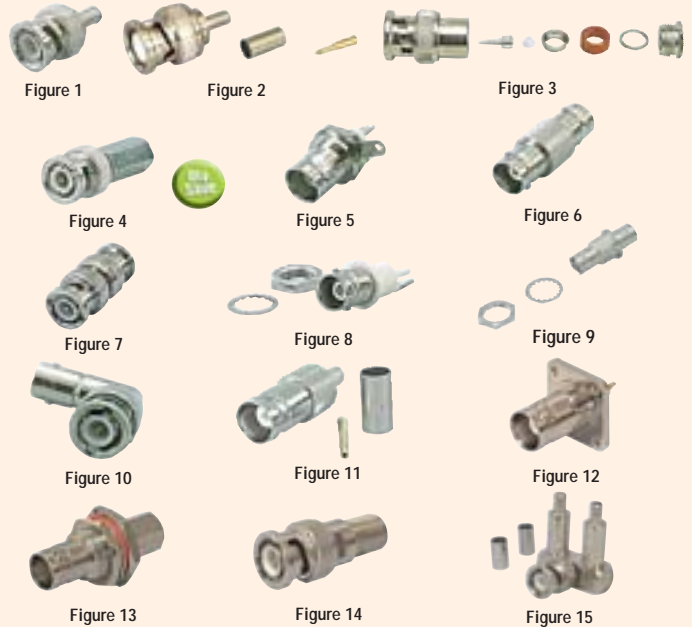

BNC PCB Connectors

- 146528CD: Ideal for applications where multiple insertions require a connector which can endure the stress of high torque
- 146510CD/161656CD: Maintains matching impedance at 50Ω & 75Ω. Ideal for LAN cards & precision video

Part No.	Description	Length (L)	1	10	100	500
146528CD	BNC straight metal	.719"	\$2.79	\$2.55	\$2.29	\$2.05
210884CD	BNC straight/panel mount metal	.830"	2.29	1.99	1.79	1.59
146510CD	BNC right-angle plastic insulation	1.37"	1.95	1.75	1.49	1.25
161656CD	BNC right-angle metal	.861"	2.29	1.99	1.79	1.59

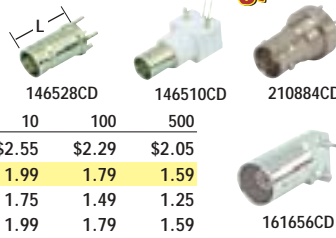

BNC Adapters

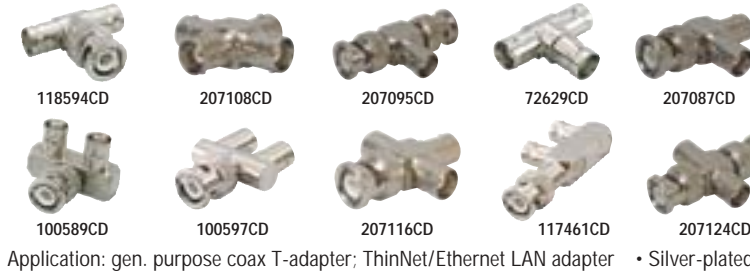

Application: gen. purpose coax T-adapter; ThinNet/Ethernet LAN adapter • Silver-plated

Part No.	Description	1	10	100	500
118594CD	Male to female/female T-adapter	\$2.39	\$2.15	\$1.75	\$1.25
207108CD	Quad female adapter	3.99	3.49	2.99	2.49
207095CD	Female to male/male T-adapter	5.95	5.35	3.99	3.49
72629CD	Female to female/female T-adapter	2.49	2.25	1.99	1.69
207087CD	Female to male/female T-adapter	9.95	8.95	6.45	5.79
207132CD	Female to bulkhead female (rt. angle)	4.59	4.15	3.75	3.35
100589CD	Male to female/female T-adapter (90°)	3.95	3.55	3.19	2.89
100597CD	Male to female/female T-adapter (180°)	5.79	5.25	4.69	4.25
207116CD	Male to female/female/female T-adapter	7.19	6.49	5.85	5.25
117461CD	Male to female/female F-adapter (90°)	3.99	3.59	3.15	2.75
207124CD	Male/male to female/female T-adapter	4.49	4.05	3.65	3.29
207167CD	RCA female to BNC female	1.99	1.79	1.59	1.39
114788CD	RCA female to BNC male adapter	1.35	1.05	.99	.98
207175CD	RCA male to BNC male	1.99	1.79	1.59	1.39
114753CD	RCA male to BNC female adapter	1.59	1.45	1.29	1.19
114770CD	BNC female to "F" connector male adapter	1.79	1.59	1.39	1.19
207141CD	3.5mm mono male to BNC female	1.99	1.79	1.59	1.39
207159CD	2.5mm mono male to BNC female	2.99	2.69	2.39	1.99



BNC Coax Cables



Part No.	Description	1	10	50	100
181307CD	Male coax connectors				
152311CD	RG6 75Ω Cables				
85542CD	RG58/U 50Ω Cables				
176794CD	3' BNC to BNC	\$3.95	\$3.55	\$3.19	\$2.89
176815CD	6' BNC to BNC	4.95	4.49	3.59	2.65

RG6 75Ω Cables

Part No.	Description	1	10	50	100
176794CD	3' BNC to BNC	\$3.95	\$3.55	\$3.19	\$2.89
176815CD	6' BNC to BNC	4.95	4.49	3.59	2.65

RG58/U 50Ω Cables

Part No.	Mfr. Cross Ref. No.	Lgth (ft.)	1	10	50	100
181307CD	CRG58-1RR	1	\$3.15	\$2.85	\$2.55	\$2.35
102314CD	CRG58-1	1.5	3.49	3.15	2.85	2.55
11404CD	CRG58-3	3	3.95	3.59	3.25	2.89
102331CD	CRG58-6	6	3.69	3.29	2.99	2.69
152311CD	RG58MF-6*	6	2.95	2.59	2.25	1.95
180822CD	CRG58-10	10	4.49	4.05	3.65	3.29
102349CD	CRG58-12	12	4.95	4.49	3.99	3.39
169818CD	CRG58-15	15	5.49	4.95	3.95	2.95
102357CD	CRG58-25	25	6.49	5.85	5.29	4.75
102365CD	CRG58-50	50	9.49	8.55	7.69	6.89
102381CD	CRG58-100	100	13.49	12.15	9.75	7.15

*152311CD has male and female coax connectors

RG59/U 75Ω Cables

Part No.	Mfr. Cross Ref. No.	Lgth (ft.)	1	10	50	100
86471CD	CRG59-1	1.5	\$2.99	\$2.69	\$2.45	\$2.19
85542CD	CRG59-6	6	3.75	3.39	2.99	2.75
226253CD	BZA3636	8	4.49	3.95	3.65	3.29
102373CD	CRG59-12	12	5.49	4.95	4.45	3.99

RG174/U 50Ω Cables

Part No.	Mfr. Cross Ref. No.	Lgth (ft.)	1	10	50	100
111472CD	RG174U3	3	\$3.85	\$3.49	\$3.15	\$2.85
111481CD	RG174U6	6	4.59	4.15	3.75	3.35

SMB PCB Connector

- 0-4GHz electrical performance
- Gold plated brass
- Insulation: teflon
- Contact: beryllium copper

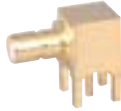

Part No.	Description	1	10	50
167311CD	Fem. right angle PCB ..	\$4.75	\$4.29	\$3.69

SMB PCB Jack Connectors

- SMB bulkhead jacks for RG-174 cable
- 50Ω crimp type
- Gold plated
- Use with crimping tool P/N 114534CD, pg 164

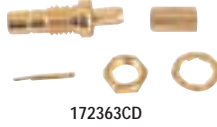

Part No.	Description	1	10	50
172363CD	Bulkhead crimp female	\$3.49	\$2.95	\$2.49
172371CD	Bulkhead crimp male	4.29	3.89	3.49

SMA/SMB 50Ω Coax Cables

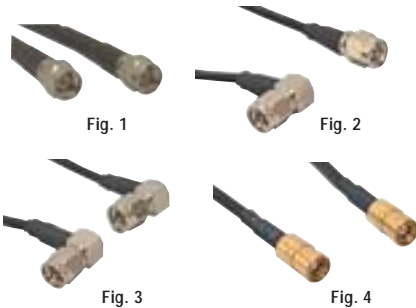

Fig. 1

Fig. 2

Fig. 3

Fig. 4

- Fig. 1: SMA male to SMA male
- Fig. 2: SMA male to SMA right angle male
- Fig. 3: SMA right angle male to SMA right angle male
- Fig. 4: SMB male to SMB male

Part No.	Cable	Fig.	Lgth (ft.)	1	10	50
159370CD	RG58	1	2	\$4.49	\$3.99	\$3.49
159396CD	RG58	1	6	5.49	4.89	4.19
169800CD	RG174	1	0.5	5.59	4.99	4.55
163854CD	RG174	1	1	4.49	3.95	3.39
153381CD	RG174	1	2	4.95	4.29	3.39
153390CD	RG174	1	4	5.49	4.75	4.29
159450CD	RG174	1	4	6.79	6.15	5.55
175126CD	RG174	2	0.5	4.49	3.95	3.49
175134CD	RG174	2	1	4.95	4.25	3.75
175142CD	RG174	3	0.5	5.75	5.25	4.49
175151CD	RG174	3	1	6.25	5.75	4.75
175169CD	RG174	4	0.5	4.25	3.19	2.25
175177CD	RG174	4	1	5.29	4.79	3.95

F-Type 75Ω Coax Cable

- Low signal loss
- Strain relief
- Male to male F-type



Part No.	Cable	Lgth (ft.)	1	10	50	100
85585CD	RG59	3	\$2.39	\$2.15	\$1.72	\$1.29

30-Day Money-Back Guarantee

If you're not satisfied we'll take it back!
Details on page 217.

SMA Connectors, Adapters and Couplers



- Application: cellular phone, data communication, instrumentation, and video
- 50Ω impedance
- Frequency range: 0-18GHz
- Temperature range: -65° C to 165° C
- Plating: gold and nickel

Connectors

Part No.	Description	Cable Type	Plated	1	10	50	100
157972CD	SMA 50Ω crimp type male plug connector	RG58	Gold	\$3.99	\$3.59	\$3.29	\$2.99
153365CD	SMA 50Ω crimp type male plug connector	RG174	Gold	4.39	3.95	3.55	3.19
145381CD	SMA straight female PCB mount connector, 4 legs	—	Gold	5.25	4.75	4.25	3.49
145373CD	SMA 90° female PCB mount connector, 4 legs	—	Gold	7.39	6.65	5.95	5.39
153285CD	SMA bulkhead solder female w/ washer, rear mount	RG58/174	Gold	3.29	2.99	2.69	2.45
159530CD*	SMA female panel mount conn., 4 mounting holes	RG58/174	Gold	2.95	2.65	2.35	2.10
160021CD*	SMA female panel mount conn., 2 mounting holes	RG58/174	Gold	3.99	3.59	3.25	2.95
160012CD	Panel mount feed thru connector female – female	—	Nickel	4.49	4.05	3.65	3.29
188509CD	SMA PCB straight jack	—	Gold	3.69	3.35	2.99	2.69
188525CD	SMA PCB right angle jack	—	Gold	5.95	4.95	3.79	3.35

*159530CD/160021CD: Solder cup

SMA to BNC Adapters



Part No.	Description	Cable Type	Plated	1	10	50	100
153453CD	SMA female to BNC male adapter	—	Nickel	\$2.49	\$2.25	\$1.99	\$1.79
159468CD	SMA female to BNC female adapter	—	Nickel	2.69	2.45	2.19	1.99
153592CD	SMA male to BNC male adapter	—	Nickel	3.39	3.05	2.75	2.49
159476CD	SMA male to BNC female adapter	—	Nickel	2.99	2.69	2.45	2.19

Couplers



Part No.	Description	Cable Type	Plated	1	10	50	100
153293CD	SMA straight coupler female – jack-to-jack	—	Gold	\$3.85	\$3.39	\$2.19	\$1.79
161277CD	3-way coupler, 1 male – 2 female	—	Gold	3.49	3.15	2.85	2.45
161293CD	Straight coupler male – male	—	Gold	3.15	2.85	2.55	2.35
161306CD	Right angle coupler male – female	—	Gold	4.99	4.49	3.99	3.65

Don't worry about backorders.
Over 99% of our products are in stock!

We'll Send It Today!

Just place your order by 6PM EST
for same business day shipment.



European Terminal Blocks

- Number of poles: 12
- 1.2mm raised base
- Working temperature: 230°F (110°C)
- Material: Polyamide 66 (nylon 66), UL94V2, natural
- Terminal insert: brass metal alloy, nickel plated
- Wire protector: stainless steel spring
- Screws: zinc plated, yellow chromed
- Voltage: 600V



215010CD

Part No.	Prod. No.	Amps	AWG	1	10	100
215010CD	PA8H	20A	12-22 ..	\$1.79	\$1.59	\$1.29
215028CD	PA10H	30A	10-22	1.89	1.69	1.39
215036CD	PA12H	35A	10-22	2.59	2.29	1.99

KULKA® 601 GP Series Double Row Terminal Blocks

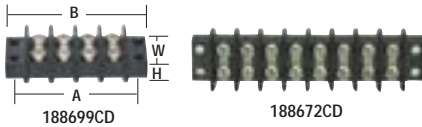

- Base: general purpose phenolic; 150°C
- Screws: #6-32, binder head, phillips-slot
- Terminals: brass plated • Width (W): 1.12"
- .437" (11 mm) centers • Height (H): .50"
- 1100Vrms; 20A ratings; for 14-16 AWG wires
- Open block design
- UL/CSA/CE approved



Part Number	Product Number	Poles	Dimensions		1	10	50
			A"	B"			
188699CD	601GP4	4	2.19	2.50	\$1.69	\$1.49	\$1.35
188681CD	601GP6	6	3.06	3.38	2.39	2.19	1.89
188672CD	601GP8	8	3.94	4.25	2.95	2.75	2.49
188664CD	601GP10	10	4.81	5.13	3.49	3.25	2.95
188701CD	601GP12	12	5.69	6.00	5.49	4.95	3.95

Double Row Terminal Blocks

- Wire gauge range: 12-18 AWG
- Body Material: black thermoplastic (UL94V-0)
- Terminals: brass tin plated
- Screws: steel nickel plated
- Insulation withstanding voltage: 2000VAC min.
- Insulation resistance: 1000MΩ or more at 500VDC

10A @ 600V

- Screw size: M3.0
- Width (W): 19.5mm
- Height (H): 11.9mm



208872CD

Part Number	Product Number	Poles	Dimensions		1	10	50
			A"	B"			
208856CD	GGE-10-4P	4	47.5	55	\$.99	\$.89	\$.79
208864CD	GGE-10-6P	6	64.5	74	1.39	1.25	1.15
208872CD	GGE-10-8P	8	95	102.5	1.69	1.59	1.49
208899CD	GGE-10-10P	10	104.5	112	2.39	2.15	1.89
208881CD	GGE-10-12P	12	123.5	131	2.79	2.49	2.25

20A @ 600V

- Screw size: M3.5
- Width (W): 22.0mm
- Height (H): 13.2mm



207571CD

Part Number	Product Number	Poles	Dimensions		1	10	50
			A"	B"			
207538CD	GGE-20-4P	4	54.5	63.5	\$1.39	\$1.25	\$1.10
207546CD	GGE-20-6P	6	76.3	85.3	1.99	1.79	1.59
207554CD	GGE-20-8P	8	98.1	107.1	2.59	2.35	2.15
207562CD	GGE-20-10P	10	119.9	128.9	3.29	2.99	2.69
207571CD	GGE-20-12P	12	141.7	150.7	3.59	3.19	2.79

DINKLE .197" (5mm) Terminal Blocks

- Materials: housing: polyimide; solder: tin plated brass
- Lead spacing: .197"
- Wire range: 12-24 AWG
- Contact rating: 300V @ 10A
- PC mount
- Insulation resistance: 500MΩ or more @ 500V
- Modular housing: end-to-end stackability
- Terminals interlocking with same series

DT Series

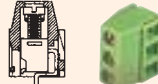

DT128 Type (Side Entry)

- Block width & height: .40" x .55" Fig. 1 99397CD

Part No.	Fig.	Term.	Block Lgth	1	10	100	1000
99426CD	1	2	0.4"72	\$.55	\$.44	\$.40
99397CD	1	3	0.6"99	.89	.79	.59

EK500 Series



EK500V Type (Side Entry)

- Block width & height: .40" x .55"
- | Part No. | Fig. | Term. | Block Lgth | 1 | 10 | 100 | 1000 |
|----------|------|-------|------------|-----|-------|-------|-------|
| 160784CD | 2 | 2 | 0.4" | .75 | \$.65 | \$.50 | \$.43 |
| 160792CD | 2 | 3 | 0.6" | .95 | .85 | .75 | .69 |

EK500A Type (45° Entry)

- Block width & height: .48" x .61"
- | Part No. | Fig. | Term. | Block Lgth | 1 | 10 | 100 | 1000 |
|----------|------|-------|------------|-----|-------|-------|-------|
| 161066CD | 3 | 2 | 0.4" | .75 | \$.65 | \$.49 | \$.39 |
| 161058CD | 3 | 3 | 0.6" | .95 | .85 | .75 | .69 |

Nylon Standard Cable Ties



70560CD

- Cable ties made from UL approved Nylon 66
- Temperature range: -40°C to +85°C
- Flammability rating: UL 94V-2
- Color: clear (except P/N 182676CD)
- Sold in increments of 100 or 1000

Part No.	Tensile Strength (lbs.)	Dimensions (L" x W")		100	1000
		Length	Width		
70560CD	18	3.1 x 0.10	\$.025	\$.015
126543CD	18	4.0 x 0.1002	.014
182676CD	18*	4.75 x 0.13035	.025
182650CD	18	5.5 x 0.13035	.025
139150CD	18	8.0 x 0.1005	.031
182668CD	18	8.0 x 0.13075	.05
182684CD	18	8.0 x 0.18036	.033
70906CD	40	5.8 x 0.10035	.029
190756CD	40	10.0 x 0.14099	.075
190772CD	40	11.0 x 0.1910	.07
190764CD	40	13.0 x 0.1410	.075

* Black



See page 122 for more Cable Ties.

OST .200" (5.08mm) Vertical Terminal Blocks

Side Entry

- Rated voltage (UL): 250V
- Rated current: 15A
- Wire size: 14-22 AWG
- PCB hole diameter: .050"
- Spacing: .200"
- Insulating material: polyimide
- Terminal block: copper zinc
- Wire guard: copper nickel

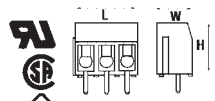

152346CD

Part No.	Term.	Size (L"xW"xH")	1	10	100	1000
152346CD	2	.42 x .35 x .49	\$.65	\$.55	\$.45	\$.39
152354CD	3	.62 x .35 x .49	..51	.46	.38	.32

OST .197" (5mm) Vertical Terminal Blocks

Side Entry

- Rated voltage (UL): 250V
- Rated current: 15A
- Wire size: 22-14AWG
- PCB hole diameter: .050"
- Spacing: .197"
- Terminal block: copper zinc



189675CD

Part No.	Term.	Size (L"xW"xH")	1	10	100	1000
189675CD	2	.42 x .30 x .37	\$.79	\$.71	\$.64	\$.58
189667CD	3	.61 x .30 x .37	..89	.80	.72	.61

OST .197" (5mm) Terminal Blocks

- Screw size: M2.6
- Rated current: 10A; 300VAC
- Insulation resistance: >500MΩ @ 500VDC
- PCB hole diameter: 1.8mm
- Wire range: 14-24 AWG
- Materials: cage clamp/ terminal/ pin header – tin plated brass
- Use with P/N 164814CD, below

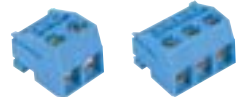

164793CD

164806CD

Part No.	Term.	Size (L"xW"xH")	1	10	100	1000
164793CD	2	.40 x .54 x .43	\$.59	\$.53	\$.47	\$.42
164806CD	3	.60 x .54 x .43	..84	.76	.62	.54

.197" (5mm) Male Header

- Snap apart to fit your application • Spacing: .197"
- Contact pin: tin plated brass • 0.05" round posts
- Use with 164793CD & 164806CD, above • 24-pin

Part No.	Mfr.	Cross Ref. No.	1	10	100
164814CD	TBH24	\$2.25	\$1.95	\$1.75

entrelec® DIN Rail-Mounted Terminal Blocks

- Foot snaps onto standard DIN and DIN 2 rails. Terminals are positively retained on rails, but can be removed without disturbing adjacent units.



185914CD

Part No.	Product No.	Type	Sold in 1 meter (39") length			
			1	10	100	
185914CD	011511607	M4/6	\$1.25	\$1.09	\$.99
185965CD	017322005	PR30	7.19	6.49	5.85

.062" (1.57mm) Power Connectors

- Passive friction lock
- Polarized housing assures proper mating
- Voltage: 250V • Current: 5.0A
- Dielectric withstanding voltage: 1500VAC_{RMS}
- Contact retention to housing: 20 lbs. minimum
- Housing: nylon; UL94V-2
- Temperature range: -40°C to +105°C



Plugs



Part No.	Product No.	Circuits	1	10	100
224477CD	03-06-2011	1	\$.29	\$.16	\$.13
224485CD	03-06-2023	2	.30	.18	.15
224493CD	03-06-2032	3	.31	.19	.16
224506CD	03-06-2042*	4	.39	.27	.24
224514CD	03-06-2044**	4	.39	.27	.24
224522CD	03-06-2061	6	.45	.28	.25
224531CD	03-06-2092	9	.49	.27	.24
224549CD	03-06-2122	12	.52	.30	.25

*In-line **Grid

Receptacles



Part No.	Product No.	Circuits	1	10	100
224397CD	03-06-1011	1	\$.29	\$.16	\$.13
224400CD	03-06-1023	2	.30	.18	.15
224418CD	03-06-1032	3	.31	.19	.16
224426CD	03-06-1042*	4	.39	.27	.24
224434CD	03-06-1044**	4	.39	.27	.24
224442CD	03-06-1062	6	.45	.28	.25
224451CD	03-06-1092	9	.49	.27	.24
224469CD	03-06-1122	12	.52	.30	.25

*In-line **Grid

.062" (1.57mm) Contacts

- Durability: tin - 25 mating/un-mating cycles max.
- Contact: brass or phosphor bronze
- Tin plating
- Temperature range: -40°C to +105°C
- Prepackaged: order in increments of 10, 100 or 1000



Crimp-Type Contacts



Part No.	Product No.	Gender	AWG	10	100	1000
224565CD	02-06-2103	M	18-24	\$.18	\$.057	\$.038
224581CD	02-06-2132	M	24-30	.18	.057	.038
224557CD	02-06-1103	F	18-24	.18	.057	.038
224573CD	02-06-1132	F	24-30	.18	.057	.038

Solder-Tail Contacts



Part No.	Product No.	Gender	10	100	1000
227379CD	02-06-8103	Male	\$.18	\$.11	\$.066
227387CD	02-06-7103	Female	.18	.11	.066

.093" (2.36mm) Power Connectors

- Passive friction lock
- Voltage: 250V
- Current: 12A per circuit
- Dielectric withstanding voltage: 1500VAC_{RMS}
- Contact retention to housing: 20 lbs. minimum
- Housing: nylon; UL94V-2
- Temperature range: -40°C to +105°C



Plugs



Part No.	Product No.	Circuits	1	10	100
224063CD	03-09-2011	1	\$.29	\$.18	\$.12
224071CD	03-09-2022	2	.30	.25	.18
224080CD	03-09-2032	3	.41	.32	.21
224098CD	03-09-2042	4	.45	.22	.20
224101CD	03-09-2062	6	.49	.39	.29
224119CD	03-09-2092	9	.55	.35	.30
224127CD	03-09-2121	12	.69	.59	.39

Receptacles

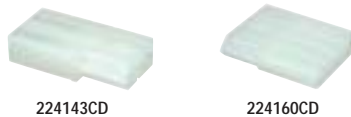

Part No.	Product No.	Circuits	1	10	100
224135CD	03-09-1011	1	\$.29	\$.09	\$.08
224143CD	03-09-1022	2	.30	.25	.18
224151CD	03-09-1032	3	.44	.25	.16
224160CD	03-09-1042	4	.46	.25	.22
224178CD	03-09-1064	6	.49	.23	.20
224186CD	03-09-1094	9	.69	.59	.39
224194CD	03-09-1126	12	.75	.49	.39

.093" (2.36mm) Contacts

- Durability: tin - 25 mating/un-mating cycles max.
- Contact: brass or phosphor bronze
- Tin plating
- Temperature range: -40°C to +105°C
- Prepackaged: order in increments of 10, 100 or 1000



Crimp-Type Contacts



Part No.	Product No.	Gender	AWG	10	100	1000
224207CD	02-09-2118	M	18-22	\$.19	\$.06	\$.04
224223CD	02-09-2103	M	14-20	.18	.059	.04
224215CD	02-09-1119	F	18-22	.20	.07	.04
224231CD	02-09-1104	F	14-20	.18	.059	.04

Solder-Tail Contacts



Part No.	Product No.	Gender	10	100	1000
224240CD	02-09-2133	Male	\$.149	\$.129	\$.091
224258CD	02-09-1134	Female	.20	.14	.09

.062" Power Connector Kit

This assortment kit contains mating sets of housings and pins.

- Voltage: 250VAC • Current: 5A
- Temperature range: -40°C to +105°C



Includes: 3 ea. 2-pin plugs and 2-pin receptacles, 8 ea. male contacts, and female contacts.



Part No.	Product No.	Description	1	10	50
142113CD	1625-2	Kit	\$5.69	\$5.15	\$4.59

.093" Power Connector Kits

These assortment kits contain mating sets of housings and pins.

- Voltage: 250VAC
- Temperature range: -40°C to +105°C

- 142181CD: • 3 ea. 2-pin plugs & receptacles, 8 ea. female & male contacts • Current: 12A
- 142201CD: • 2 ea. 4-pin plugs & receptacles, 10 ea. female & male contacts • Current: 9A
- 142228CD: • 2 ea. 6-pin plugs & receptacles, 14 ea. female & male contacts • Current: 9A

Includes: Male and female tin-plated standard brass .010" pins; 18-22 AWG crimp size wire

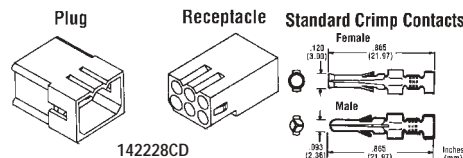

Part No.	Product No.	Description	1	10	50
142181CD	1545	Kit	\$4.95	\$4.49	\$3.95
142201CD	1490	Kit	5.69	5.15	4.65
142228CD	1261	Kit	5.25	4.75	3.95

Extraction Tools for Molex Power Connectors

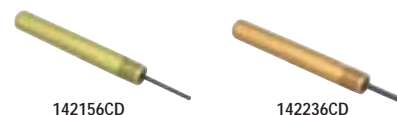

142156CD/227467CD: Tool for .062" connectors
142236CD/227395CD: Tool for .093" connectors

Part No.	Product No.	AWG	1	10
142156CD	W-HT-2285	18-30	\$14.49	\$13.49
227467CD	W-HT-2023	18-30	11.99	10.99
142236CD	W-HT-2038	14-30	14.49	13.49
227395CD	W-HT-2054	14-30	11.99	10.99

Hand Crimp Tool



This tool is designed to crimp terminals, strip and cut wires, and cut bolts. Cuts and strips wires from 30-18AWG. For Molex crimp pin terminals with .062" and .093" diameters.



- Length: 8.3"L • Weight: 0.5 lbs.

Part No.	Product No.	1	10
227491CD	W-HT-1921	\$14.99	\$13.99

.156" (3.9mm) Center Straight-Friction Lock Headers

- Ideal for AC and DC power distribution
- Voltage rating: 250VAC/VDC max.
- Current rating: 7 amps AC/DC
- Contact resistance: 20mΩ
- Temperature range: -25°C to +85°C
- Header material: pin - brass/tin-plated
- Base: nylon 66, UL94V-2



* Prepackaged: order in increments of 10, 100, 1000

Part No.	Cross Ref. No.	Pins	1	10	100	1000
104791CD	LMH4	4*	\$.11	\$.09	\$.07
104803CD	LMH5	5*	.14	.11	.09
104811CD	LMH6	6*	.15	.12	.10
104838CD	LMH8	8*	.12	.11	.099
104846CD	LMH10	10*	.29	.25	.19

.156" (3.9mm) Center Housing Connectors

- Common to many power supplies carried by Jameco. Some power supplies (pgs 7-0) may require multiple connectors
- Housing material: nylon 66, UL94V-2
- Use with crimp pins, 78318CD, below

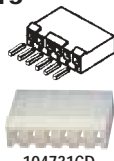

* Prepackaged: order in increments of 10, 100, 1000

Part No.	Cross Ref. No.	Pins	1	10	100	1000
176743CD	LCH2	2*	\$.07	\$.045	\$.04
104432CD	LCH3	3*	.19	.12	.11
104715CD	LCH4	4*	.22	.15	.12
104723CD	LCH5	5*	.26	.24	.17
104731CD	LCH6	6*	.33	.30	.24
104766CD	LCH10	10*	.39	.32	.28

.156" (3.9mm) Center Crimp Pin

- Use with .156 housings (above)
- Use 159265CD crimping tool, pg 164
- Material: brass/tin plated
- Pin wire gauge: 22-26 AWG

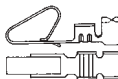

Prepackaged: order in increments of 10, 100, 1000

Part No.	Mfr. Cross Ref. No.	10	100	1000
78318CD	AMP501T*	\$.11	\$.08

.156" Female Crimp Pins

SALE

- Pin wire gauge: 18-22 AWG
- Material: tin-plated brass
- Use 99442CD crimping tool, pg 164



Prepackaged: order in increments of 10, 100 or 1000

Part No.	Mfr. Cross Ref. No.	10	100	1000
154093CD	LRPIN*	\$.07	\$.05



More Crimping Tools for above Crimp Pins See page 164.



0.118"-Pitch ATX Power Connectors for Motherboards & Power Supplies

- Voltage rating: 250V AC/DC
- Current rating: 7A AC/DC
- Temperature range: -25°C to 85°C
- Insulation resistance: 1000MΩ min.
- Withstanding voltage: 1500V/min.

147379CD: ATX male 20-pin edge mount connector

• Material: nylon 66, UL-94V0

• Material of post: tin-plated brass • Diameter of post: .045"

147387CD: Housing connector • Material: nylon 66, UL-94V0

147395CD: ATX power terminal pins • Material: tin-plated brass

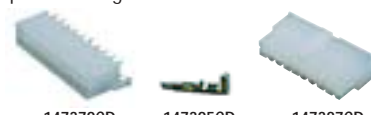

* Prepackaged: order in increments of 10, 100 or 1000

Part No.	Description	L	W	H	Dia	Use With	1	10	100	1000
147379CD	20-pin male connector	1.7"	0.4"	0.6"	—	—	\$.59	\$.53	\$.48	\$.43
147387CD	20-pin housing connector	1.7"	0.4"	0.8"	—	147395CD	*	.19	.17	.15
147395CD	Power terminal pin, female	.59"	—	—	.068"	147387CD	*	.12	.11	.10

0.098"-Pitch AT Power Connectors for Motherboards & Power Supplies

- Voltage rating: 250V AC/DC
- Current rating: 7A AC/DC
- Temperature range: -25°C to 85°C
- Insulation resistance: 1000MΩ minimum
- Withstanding voltage: 1500V/min.

78300CD: AMP60G male 6-pin PCB mount connector

• Material of post: tin-plated brass • Diameter of post: .09"

78326CD: AMP50G female 6-pin housing connector • Material: nylon

78318CD: AMP501T terminal pin

• Material: tin-plated brass



* Prepackaged: order in increments of 10, 100 or 1000

Part No.	Description	L	W	H	Dia	Use With	1	10	100	1000
78300CD	6-pin male connector	.93"	.37"	.57"	—	—	\$.45	\$.39	\$.35	\$.31
78326CD	6-pin housing connector	.94"	.25"	.74"	—	78300CD	.35	.31	.28	.25
78318CD	Power terminal pin, female	.69"	—	—	.09"	78326CD	*	.11	.08	.07

.156" (3.9mm) Center Housing Connectors and Crimp Contact

- Mating connectors for Mean Well LPS and LPP series power supplies (pgs 17-19)
- Current rating: 10A AC/DC
- Voltage rating: 250V AC/DC



227416CD:

- Material: brass
- Finish: tin-plated
- 18-22 AWG



* Prepackaged: order in increments of 10, 100, 1000

Part No.	Description	1	10	100	1000
215950CD	5 pos. housing*	\$.35	\$.32	\$.28
215976CD	8 pos. housing*	.39	.35	.28
215968CD	12 pos. housing*	.49	.44	.39
227416CD	Crimp contact*	.29	.19	.10

Extraction Tools for Crimp Pins

- Quickly and easily extract 0.093" locking pins from interlocking connectors
- Length: 5"
- See right for crimp pins, 42729CD & 42649CD



Part No.	Product No.	Description	1	10
131887CD	HT319C	Male tool for 42729CD	\$.95	\$.85
131879CD	HT319B	Fem. tool for 42649CD	9.95	8.95

Corporate Customers



Opening an account is easy!!

Call 1-800-831-4242 for details today.

0.2"-Pitch Power Connectors and Pins

Connector & Housing Specifications:

- Voltage rating: 250VAC (Mate-N-Lock 600VAC)
- Operating temperature: -55°C to +105°C

Crimp Pin Specifications:

- Material: tin plated brass • Current rating: 1.5 amps
- Wire size range: 18-24 AWG
- Use crimp tool P/N 99442CD, pg 164

For 5.25" Disk Drives and Power Supplies

42075CD & 42067CD Connector Housings:

- Keyed mating connectors
- External key bar indicates pin 1



• See far left for extraction tools, 131887CD & 131879CD

* Prepackaged: order in increments of 10, 100 or 1000

Part No.	Description	10	100	1000
109145CD	4-pin M vert. PCB mtg*	\$.59	\$.49
117567CD	4-pin M PCB mounting, horizontal edge mount*	.63	.55
42075CD	4-pin M housing*	.12	.11
42067CD	4-pin F housing*	.23	.18
42729CD	M crimp pin for 42075CD*	.10	.07
42649CD	F crimp pin for 42067CD*	.10	.07

For 3.5" Disk Drives and Power Supplies

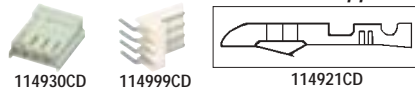

* Prepackaged: order in increments of 10, 100 or 1000

Part No.	Description	10	100	1000
114930CD	4-pin F housing*	\$.19	\$.17
114921CD	F crimp pin for 114930CD*	.11	.095
114999CD	4-pin M rt. angle PCB mtg*	\$.35	\$.31

Buzzers and Sonic Transducers

SALE

Magnetic Transducers • Applied voltage: 1/2 duty, square wave

Part Number	Fig.	Operating Volt. (Vp-p/mA)	Voltage Range (Vp-p)	Frequency (Hz)	Sound (dB)	Dimensions	Pricing			
							1	10	100	1000
138721CD	1	1.5/10	1 - 2	2048	80	.32"H x .46"Dia.	\$1.29	\$1.19	\$.91	\$.86
207917CD	2	1.5/30	1 - 2	2048	75	.22"H x .47"Dia.	1.09	.89	.75	.69
207925CD	3	1.5/70	1 - 2	2048	80	.50"L x .50"W x .30"H	.99	.89	.80	.72
207941CD	4	1.5/80	1 - 2	2731	80	.28"H x .38"Dia.	.99	.89	.80	.72
207968CD	5	1.5/80	1 - 2	2731	80	.22"H x .35"Dia.	1.09	.89	.75	.69
207909CD	2	3.6/40	1 - 4	1980	70	.22"H x .47"Dia.	.99	.84	.69	.59
138739CD	1	5/40	3 - 8	2400	85	.35"H x .46"Dia.	1.39	1.25	.89	.84
106500CD	1	5/40	3 - 8	2400	85	.40"H x .48"Dia.	1.19	.99	.79	.74
207933CD	4	5/100	4 - 8	3100	85	.28"H x .38"Dia.	1.09	.89	.75	.69
207950CD	5	5/100	4 - 8	3100	85	.22"H x .35"Dia.	1.35	1.15	.99	.89

Magnetic Buzzers

Part Number	Fig.	Operating Volt. (VDC/mA)	Voltage Range (VDC)	Frequency (Hz)	Sound (dB)	Dimensions	Pricing			
							1	10	100	1000
207984CD	6	1.5/30	1.25 - 2	2300	75	.47"H x .38"Dia.	\$2.49	\$2.19	\$1.99	\$1.69
76064CD	6	5/30	4 - 7	2300	85	.35"H x .46"Dia.	2.99	2.69	2.45	2.19
207976CD	6	12/30	8 - 15	2300	85	.47"H x .38"Dia.	2.49	2.19	1.99	1.69

Piezo Buzzers

Part Number	Fig.	Operating Volt. (VDC/mA)	Voltage Range (VDC)	Frequency (Hz)	Sound (dB)	Dimensions	Pricing			
							1	10	100	1000
206295CD	6	12/6	3 - 20	2900	95	.63"H x .92"Dia.	\$2.49	\$2.25	\$1.95	\$1.75
196357CD	6	12/5.8	3 - 16	4000	86	.30"H x .54"Dia.	2.69	2.45	2.19	1.95
138712CD	6	12/7	3 - 16	4000	80	.30"H x .54"Dia.	2.19	1.99	1.59	1.15
207896CD	7	12/120	6 - 15	2800	105	3.4"L x 2.2"W x 1.3"H	7.95	7.19	6.45	5.85
207888CD	7*	12/120	9 - 15	3100	105	3.4"L x 2.2"W x 1.3"H	8.95	7.95	6.95	6.25
207992CD	8	12/250	6 - 16	3500	105	2.3"L x 1.8"W x 1.6"H	6.95	6.29	5.65	5.09
32601CD	9	24/15	1 - 28	2900	95	1.4"H x 1.7"Dia.	4.95	4.45	3.95	3.59
123537CD	9*	24/20	4 - 28	2900	80	1.4"H x 1.7"Dia.	4.19	3.79	3.39	2.95
76021CD	10	24/20	1.5 - 28	3200	95	1.0"H x 1.1"Dia.	4.79	4.35	3.89	3.49

* P/N dual tone

Mechanical/ElectroMechanical Buzzers

Part No.	Mfr.	Cross Ref. No.	Description	Wt. (lbs.)	Pricing					
					1	10	100	1000		
24871CD	11	9/30	6 - 12	400	75	1.3"L x 0.7"W x 0.6"H	\$2.49	\$1.99	\$1.79	\$1.79
105822CD	12	9/220	—	500	80	1.3"H x 2.0"Dia.	1.39	1.25	1.15	.91
140695CD	11	12/25	9 - 15	400	75	1.3"L x 0.7"W x 0.6"H	1.79	1.59	1.49	1.29



110VAC Piezo Buzzer

- Sound pressure level: 90dB
- Output tone: pulse • 6" lead wires
- Operating range: 60-150VAC
- Current drain: 20mA
- Fits 1.125" diameter opening
- Size: 1.3"H x 1.7"Dia.



Includes: Mounting nut

Part No.	Product No.	1	10	100
184743CD	FM-110A-903AL	\$3.19	\$2.99	\$2.69

Microphones and Microphone Cartridges

VHF High-Band Wireless Microphones

The perfect microphone for use with portable PA systems, video recording, and stage use. There is no cord to restrict your movements while providing clear crisp sound.

- T.H.D. (total harmonic distortion): less than 0.5% for crystal-clear sound
- Frequency stability: ±0.005% with Quartz controlled
- Maximum deviation range: ±15kHz with limiting compressor • Transmission range: 300m
- Carrier frequency range: 100Hz to 15kHz • S/N ratio: over 180dB @ 15kHz deviation

Includes: 0.25" mono jack patch cable, 9V battery and power supply

Part No.	Mfr. Cross Ref. No.	Description	Wt. (lbs.)	1	5
198248CD	WR101R	Handheld wireless microphone	2.1	\$95.19	\$86.55
198221CD	WR202H	Wireless microphone with clip-on headset	2.3	99.95	89.95

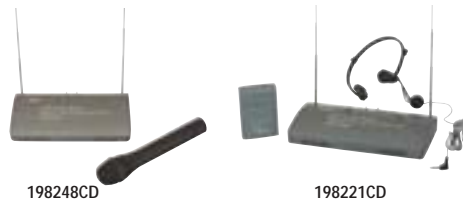

SALE

30-Day Money-Back Guarantee

If you're not completely satisfied with your purchase, we'll take it back!

Details on page 217.

Omni-directional Electret Condenser Microphone Cartridges

Applications:

- Tape recorders, intercoms, hearing aids, telephone and answering devices, sonic controlled toys and sensors
- Modems for computers
- Used for recording, testing, and monitoring

Part No.	Type	Sensitivity	Impedance	Frequency (Hz)	Max. Op. Volt. (VDC)	Stand Op. Volt. (VDC)	Current (Max.)	Sensitivity Reduction	S/N Ratio	Terminals	Size (H x Dia.)	Pricing			
												1	10	100	1000
116505CD	WM-54PC	-44 ±2dB	>2.2kΩ	20-16,000	10V	2.5V	0.6mA	-3dB @ 2V	>60dB	PC pin leads	.20" x .38"	\$7.75	\$6.67	\$5.55	\$4.49
160979CD	WM-64PKT	-44 ±3dB	>2.2kΩ	20-16,000	10V	2.0V	0.5mA	-3dB @ 1.5V	>58dB	PC pin leads	.10" x .24"	.79	.71	.64	.57
136573CD	WM-60PC	-54 ±2dB	>2.2kΩ	20-12,000	12V	4.5V	0.5mA	-3dB @ 3V	>40dB	PC pin leads	.30" x .38"	.53	.48	.43	.39
196488CD	JL-061C	-58 0dB	2kΩ	20-20,000	10V	2.0V	0.04mA	-3dB @ 1.5V	>55dB	Solder pad	.10" x .24"	1.29	.99	.89	.79
140986CD	CRM919	-64 ±3dB	1kΩ ±30%	20-10,000	12V	3.0V	0.8mA	-3dB @ 3V	>40dB	Lead wires	.90" x .39"	1.59	1.43	1.29	1.15

Full-Range Replacement Speakers

These full-range speakers are perfect replacements for TVs, stereos, and computer systems.

- Full-range coaxial speakers provide extended frequency response and can handle higher-powered amplifiers
- Dual-cone speakers provide richer bass tones and crisper high tones
- Two-way speakers provide extended frequency response with both a tweeter and woofer
- Impedance: 8Ω

SALE

196402CD: shielded magnet prevents signal distortion of TVs, monitors, and CTRs.



Part No.	Mfr. Cross Ref. No.	Size	Type	Shape	Freq. Range	Magnet Wt. (oz.)	RMS Watts	Pricing	
								1	10
196402CD	480P039-1	4"	Full range shielded	square	120-10kHz	6	10	\$6.49	\$5.85
197042CD	5030	5"	Full range	square	135-15kHz	3	5	3.25	2.95
197077CD	6030W	6"	Full range dual cone	round	70-15kHz	3	8	4.89	4.45

Round Ferrite Speakers

- Pre-tinned speaker lugs
- Large magnet
- Anodized metal surfaces
- Braided copper voice coil leads
- Paper diaphragm



For speaker wire, see page 121

Part Number	Mfr. Cross Ref. No.	Dimensions (Dia." x D")	Input		Impedance (Ω)	Output SPL (dB)	Frequency Range (Hz)	Magnet Size (Dia." x H")	Pricing		
			Nom (W)	Max (W)					1	10	100
135589CD	FE200	2.0 x 0.7	0.2	0.4	8	83	420 – 5000	1.3 x 0.4	\$1.69	\$1.45	\$0.99
10840CD	FE201	2.2 x 0.7	0.2	0.4	8	88	400 – 4500	1.3 x 0.4	1.65	1.45	1.05
177130CD	57RF07	2.2 x 0.8	0.5	0.9	45	88	500 – 8000	1.6 x 0.5	.54	.49	.43
135714CD	FE202	2.6 x 0.8	0.3	0.5	8	88	340 – 4000	1.3 x 0.4	.65	.56	.50



135589CD side



135589CD back

Square Ferrite Speakers

- Pre-tinned speaker lugs
- Large magnet
- Anodized metal surfaces
- Braided copper voice coil leads
- Paper diaphragm

Part Number	Mfr. Cross Ref. No.	Dimensions (Dia." x D")	Input		Impedance (Ω)	Output SPL (dB)	Frequency Range (Hz)	Magnet Size (Dia." x H")	Pricing		
			Nom (W)	Max (W)					1	10	100
135693CD	FEB200	2.0 x 0.7	0.2	0.3	8	82	500 – 6000	1.3 x 0.5	\$1.59	\$1.45	\$1.29
31958CD	FEB216	2.6 x 0.8	0.2	0.4	16	85	330 – 8000	1.3 x 0.5	2.25	1.99	1.79
99995CD	FEB204	2.6 x 0.9	3.0	4.0	4	95	300 – 14000	1.8 x 0.5	2.49	2.25	1.99



99995CD side



99995CD back

Flat-Magnet, Square Piezo Speakers

- Excellent for alarms or other voice uses
- Stainless steel diaphragm

Part Number	Mfr. Cross Ref. No.	Dimensions (Dia." x D")	Input		Impedance (Ω)	Output SPL (dB)	Frequency Range (Hz)	Magnet Size (Dia." x H")	Pricing		
			Nom (W)	Max (W)					1	10	100
34024CD	AZ30S	1.2 x 0.2	0.4	0.8	8	70	1300-8000	1.2 x 0.1	\$1.69	\$1.52	\$1.35
76030CD	AZ40S	1.6 x 0.2	0.4	0.8	8	70	600-6000	1.6 x 0.1	1.95	1.75	1.49



34024CD side



34024CD back

Alnico Speakers

- For computer case use
- Paper diaphragm
- Wide frequency response
- Pre-tinned solder lugs
- Large magnet
- Impedance: 8Ω

SALE

Part Number	Mfr. Cross Ref. No.	Fig.	Dimensions (Dia." x D")	Input		Output SPL (dB)	Frequency Range (Hz)	Magnet Size (Dia." x H")	Pricing		
				Nom (W)	Max (W)				1	10	100
88410CD	A0200	1	2.0 x 0.8	0.2	0.4	87	430 – 4500	0.5 x 0.4	\$1.49	\$1.29	\$1.19
135765CD	A0201C	1	2.2 x 0.8	0.3	0.5	87	400 – 4000	0.5 x 0.4	1.59	1.35	.99
111587CD	B0102	2	1.7 x 0.6	0.1	0.3	83	500 – 5500	0.5 x 0.4	2.25	1.69	1.49
135811CD	A1527C02	3	1.6 x 2.8 x 1.2	2.0	5.0	82	450 – 20000	0.5 x 0.5	3.19	2.89	2.59



Fig. 1

Fig. 2

Fig. 3

Samarium Cobalt Low Profile Speaker

- Round frame
- Anodized metal surfaces
- Ultra thin
- Solder tabs
- Paper diaphragm
- Nominal input: 0.3W; max. input: 0.5W
- Impedance: 8Ω
- Output SPL : 85 dB
- Frequency range: 550 - 5000Hz
- Magnet size: 0.5"Dia. x 0.6"H
- Dimensions: 2.0"Dia. x 0.3"D



Side



Back

Part No.	Mfr. Cross Ref. No.	1	10	100
135626CD	MSC299	\$2.95	\$2.65	\$2.39

1.2" (30mm) PCB Mountable Speaker

- Round frame design
- Ideal for PC board mounting
- Mylar diaphragm
- Solder leads
- Nominal input: 0.15W; max. input: 0.2W
- Impedance: 8Ω
- Output SPL : 82 dB
- Frequency range: 700 - 5000Hz
- Pin spacing: 15mm
- Dimensions: 1.2"Dia. x 0.5"D



Part No.	Mfr. Cross Ref. No.	1	10	100
135722CD	PCM415	\$2.25	\$1.99	\$1.85

Don't worry about backorders. Over 99% of our products are in stock!

We'll Send It Today!

Just place your order by 6PM EST for same business day shipment.

20MHz Dual-Trace Analog Oscilloscope



EZ DIGITAL

Blue CRT for higher resolution!

- 6" rectangular high-resolution blue CRT with internal graticule & scale
- Vertical deflection: 5mV/div to 5V/div in 10 calibrated steps
- Horizontal deflection: 0.2µs/div to 0.2s/div in 19 calibrated steps, 1-2-5 sequence
- Max. signal input voltage: 250V (DC and peak AC)
- ADD function measures sum of two signals
- Input voltage: 98-125VAC @ 1A, 198-225VAC @ 0.5A, 50-60Hz, 45W
- Two-year manufacturer's warranty
- Size: 16.4"L x 12.6"W x 5.3"H • Weight: 20.8 lbs.

Includes: Two (X1/X10) 40MHz probes, power cord, manual, and block diagram

Part No.	Prod. No.	Description	1	5
136098CD	OS5020	20MHz scope ...	\$399.95	\$385.95

20MHz Dual-Trace Analog Oscilloscope with 1MHz Function Generator



EZ DIGITAL

2 Instruments in 1

- Basic specs same as OS5020 (above)
- Function generator**
- Frequency range: 0.1Hz to 1MHz (7 ranges)
- Output waveforms: sine, triangle, square, TTL pulse
- Output impedance: 50Ω
- Output voltage: 14Vp-p
- Two-year manufacturer's warranty
- Size: 12.6"L x 12.6"W x 6.8"H • Weight: 23.8 lbs.

Includes: Two X1/X10 40MHz probes, power cord, manual, BNC to alligator, and cable

Part No.	Prod. No.	Description	1	10
94650CD	OS5020G	Scope+func. gen.	\$529.95	\$499.95

20MHz Dual-Trace Analog Oscilloscope With Built-in Component Checker



Prottek

- 6" rectangular CRT with internal graticule
- Built-in component checker/tester for resistors, capacitors, coils, diodes
- Vertical sensitivity: 5mV/div to 20V/div in 12 calibrated steps (1-2-5 sequence)
- Input impedance: 1MΩ + 20pF
- Max. input (vertical amplifier): 300VDC or AC peak
- Horizontal sweep time: 0.2µs/div to 0.5s/div in 20 calibrated steps (1-2-5 sequence)
- Internal trigger sensitivity: 20Hz to 20MHz
- Size: 17"L x 14"W x 5.75"H

Includes: Two X1/X10 60MHz probes, power cord, and operations manual

Part No.	Product No.	Wt. (lbs.)	1	5
201857CD	P-3502C	15.5	\$394.95	\$375.19

20MHz Dual-Trace Analog Oscilloscope With Alt-Mag and 1mV/div Sensitivity



Prottek

- Large 6" CRT with internal graticule
- Alt-Mag sweep for simultaneous displays of the main and X5 magnified trace
- Auto-focus
- Input voltage: 100V, 120V, 220V, 240V @ 50-60Hz (selectable)
- Size: 14.8"L x 13.4"W x 5.5"H • Weight: 24 lbs.

Vertical Amplifier

- Sensitivity – 1mV/div to 1V/div (X5 Mag); 5mV/div to 5V/div in 10 steps (1-2-5 seq.)
- Bandwidth: (-3dB): DC to 20MHz
- Input impedance: 1M ohms + 25pF
- Maximum input voltage: 400V (DC or AC peak)

Horizontal Sweep

- Sweep time: 0.1µs/div to 0.2S/div in 20 steps (1-2-5 seq.); X5 mag: 20ns/div to 40ms/div

Triggering

- Sensitivity: Internal – DC to 2MHz: 2 divisions; 2MHz to 20MHz: 3 divisions

Includes: X1 and X10 probes, power cord & manual

Part No.	Product No.	Description	1	5
220679CD	PROTEK 6502	20MHz scope	\$448.95	\$425.95

20MHz Dual-Trace Analog Oscilloscope With 1mV/div Sensitivity



NEW

- 6" rectangular CRT with internal graticule
- Input sensitivity: 1mV/div
- Vertical deflection: 1mV/div – 1V/div (X5Mag); 5mV – 5V/div in 10 steps (1-2-5 sequence)
- Bandwidth (-3dB): DC – 20MHz
- Input impedance: 1MΩ; 25pF
- Horizontal deflection: 0.2µs/div – 0.2s/div in 19 steps (1-2-5 sequence); X10Mag extends maximum sweep rate to 20ns/div
- Trigger system: internal and external trigger system
- External maximum input voltage: 300V (DC+AC)
- Input voltage: 110V/220V @ 48-62Hz
- Size: 14.5"L x 12.2"W x 5.1"H • Weight: 14.3 lbs.

Part No.	Product No.	1	5
226261CD	AEEC-2550S	\$389.95	\$369.95

100MHz Dual-Trace Analog Oscilloscope



EZ DIGITAL

- 2-channel dual trace
- Delay line
- Auto focusing according to intensity
- Two-year warranty
- Weight: 22.8 lbs.
- Size: 16.9"L x 12.6"W x 5.5"H

Includes: Two (X1/X10) 100MHz probes, power cord, and operations manual

Part No.	Prod. No.	Description	1	5
121179CD	OS5100	Oscilloscope	\$1,195.95	\$1,139.95

100MHz Delayed Sweep Analog Oscilloscope w/ Frequency Counter

2 Channel, 4 Trace

EZ DIGITAL

- DC to 100MHz bandwidth
- 6" rectangular CRT with internal graticule
- Auto set, readout cursor, delay sweep, hold-off functions
- Z-axis intensity modulation: DC to 2MHz bandwidth; 30VDC + peak AC max. input voltage
- Vertical deflection factor: 2mV/div to 5V/div
- Horizontal time base A/B deflection: 5ns/div to 0.5s/div in 22 calibrated steps
- Input coupling: AC, GND, DC
- Rise time: 3.5ns or less

Includes: Two X1/X10 100MHz probes, power cord, and operations manual

Part No.	Product No.	Wt. (lbs.)	1	5
190932CD	OS5100RB	17.6	\$1,099.95	\$1,044.95

100MHz Notebook DSO with 3 3/4-Digit DMM



SALE

- Direct hardcopy through RS-232 interface
- Extra bright 5" backlit LCD display
- Oscilloscope:**
- Vertical axis: 8-bits resolution with 1mV/div to 5V/div in 12 steps; 1MΩ/25pF input impedance
- Horizontal axis: 25MS/s real time sampling rate; 5ns/div to 9.5s/div real time sampling rate
- Math parameter of amplitude, frequency, period, pulse width, duty cycle
- Arithmetic functions (addition, subtraction, inversion)
- Two channels and dual digitizers
- Low drift and internal noise
- CH1, CH2 turned on or off independently
- Auto set-up and tracking
- 4,000-Count 3 3/4 Digit Multimeter:**
- DC/AC voltage ranges: 400mV to 400V in 4 ranges with resolution of 0.1mV to 100mV
- Resistance ranges: 400Ω to 400MΩ in 5 ranges with resolution of 0.1Ω to 1KΩ
- Diode test, continuity test, min./max./relative hold

Includes: Serial cable, software, oscilloscope probes, multimeter probes, power supply and NiCad battery

Part No.	Product No.	Wt. (lbs.)	1	5
190924CD	OS310M	8.6	\$1,399.95	\$1,259.95

30-Day Money-Back Guarantee

If you're not completely satisfied with your purchase, we'll take it back!

Details on page 217.

Dual-Channel 150MHz Digital Oscilloscope

- Repetitive B/W: 150MHz
- Sample rate: 100MS/s max. (real time)
- Record length: 32k
- Resolution: 8-bits
- 5.7" mono LCD display (320 x 240)
- Math functions and set-up save/recall
- Automatic measurement amplitude, auto set-up of vertical, horizontal D.F., & trigger level
- Vertical sensitivity: 2mV/div to 5V/div
- Input impedance: 1MΩ or 50Ω, 20pF nominal
- Max. input: 300V@1MΩ; 5V @ 50Ω
- Horizontal time base range: 2ns/Div to 5s/Div
- Trigger sensitivity: DC – 10MHz; 0.5 Div.
- Input voltage: 90 to 250VAC @ 48-440Hz
- Size: 12.9"L x 12.3"W x 5.9"H • Weight: 13.2 lbs.



EZ DIGITAL

Includes: Two (X1/X10) 250MHz probes, power cord, and operations manual

Part No.	Product No.	1	5
201865CD	DS-1150	\$1,599.95	\$1,519.95

Handheld 5MHz Oscilloscope with 4000-Count Digital Multimeter

- 128 x 128 pixel graphic STN LCD
- E/L backlight
- PC interface via RS-232
- Memory and recall for 4 values
- **221962CD:** With temperature measurement
- **225912CD:** With logic test



221962CD

Oscilloscope:

- DC-5MHz bandwidth; 20MS/sec. sampling rate; single channel
- Vertical axis: 3 steps (±0.5/5/50 volts) with 4 divisions
- Horizontal axis: 16 steps (800ns/div to 26.2ms/div) in 8 divisions
- Trigger: auto and internal mode, slope and 5 trigger level selectable
- Text display for peak to peak, min/max voltage and frequency

Digital Multimeter:

- 3¼-digit with 43 segment bargraph
- Auto ranging; triple display for related reading; data and range hold; auto/min/max hold and relative offset
- **DC voltage ranges:** 400mV – 1000V
- **AC voltage ranges:** 4V – 750V
- **DC/AC current ranges:** 400µA – 400mA
- **Resistance ranges:** 400Ω – 40MΩ
- **Frequency ranges:** 4kHz – 4MHz
- **Temperature ranges:** -40°C – +1200°C (221962CD only)
- **Capacitance ranges:** 4nF – 400µF
- Diode, continuity, and logic test (225912CD only) – text displayed as HI, ----, LO
- Size (unit): 8.0"H x 3.4"W x 1.5"D
- Weight: 3.9 lbs.

METEX®

Includes: Manual, power adapter and test leads

Part No.	Description	1	5
221962CD	MS-1280 (w/ temperature)	\$349.95	\$332.49
225912CD	MS-1280L (w/ logic test)	349.95	349.95
221938CD	RS-232 cable & software	19.95	18.95
221946CD	Scope Probe	24.95	23.69
221954CD	Holster	5.95	5.65

Handheld 1MHz Digital Oscilloscope and Multimeter

Six Units in One!

- 4,000 count True-RMS DMM
- 1MHz bandwidth oscilloscope
- 20MHz sampling rate
- Logic test
- Frequency counter
- Trend mode allows recording of sine waves for a period of time
- Component test • Three-year warranty



FREE
Protective Boot –
\$19.95 value!

SALE

Includes: AC charger, test leads & manual

Part No.	Description	1	5
160805CD	440 digital oscilloscope ...	\$328.95	\$312.55
168330CD	RS-232 software and cable	69.95	62.95

Handheld 5MHz Digital Oscilloscope

- 5MHz for repetitive signals; 0.5MHz for single shot events
- Input impedance: 1MΩ/20pF
- Max. input volt.: 100V peak (AC + DC)
- Input coupling: DC, AC, and GND (GND for auto zero reference)
- LCD graphics display: 64 x 128 pixels (64 x 96 pixels for signal)
- Vertical resolution: 8-bit (6-bit for LCD)
- Timebase range: 2µs to 20s/div
- Input sensitivity: 5mV to 20V/div
- Trigger mode: run, normal, once, and ± slope
- True RMS and dB measurements • Linearity: ±1 bit
- High contrast LCD display w/ 3.3" viewing angle
- Recommend 9VDC @ 300mA power supply (P/N 133891CD, pg 55) • Screen hold
- Batteries not included, recommend P/N 32627CD or P/N 151087CD, pg 202 • Weight: 1.6 lbs.



valleman

Includes: Insulated BNC-to-alligator clip measurement probes and case

SALE

Part No.	Description	1	5
168823CD	5MHz scope (Model HPS5)	\$168.95	\$158.95

Handheld 20MHz Digital Oscilloscope & Multimeter

- 4-in-1: digital oscilloscope, DMM, frequency counter & logic analyzer
- **Oscilloscope:** 2-channel input, 5mV-2V/div; DC-20MHz(-3dB); 50ns – 0.5µs/div; 20 MS/s sampling rate
- **Logic analyzer:** 8 inputs; 1.4V threshold level; 35VDC max. input; 50ns min. pulse width
- **Digital multimeter:** 3¼-digit (max. 3999 counts); 40 segment analog bargraph; AC/DC voltage 400mV-600V; AC current 40µA-400mA; DC current 400µA-400mA; resistance 400Ω-40MΩ; continuity & diode testing
- **Frequency counter:** 5Hz-20MHz; 5 digit max.; autoranging; AC/DC/DC input coupling; ±10ppm accuracy; 35Vrms/42V-P/60VDC max. input
- Oscilloscope probes: Use P/N 22891CD/216047CD/140687CD, pg 140 • One-year warranty
- Battery required for portable use (see below)
- Size: 10.0"L x 5.0"W x 2.0"H • Weight: 9.2 lbs.



(Shown w/ logic probe P/N 162974CD – not included)

Includes: Manual, 5VDC @ 3A power supply, power cord, DMM test leads, holster and case

Part No.	Description	1	5
162430CD	20MHz digital scope	\$749.95	\$712.49
162974CD	Logic probe	59.95	53.95
163141CD	Rechargeable battery	45.95	41.49
162966CD	RS-232 cable and software	26.95	24.25
221946CD	Scope probe	24.95	23.69

Fluke 123 20MHz Industrial Scopemeter® with FlukeView Software

Digital Scope, 15-Function Digital Multimeter & Recorder

The Fluke 123 is the ideal choice for troubleshooting industrial machinery, instrumentation, and power systems. Automatically recognizes signal patterns and sets up correct triggering, timing, and amplitude for stable displays.

FLUKE



- **Recorder:** dual-channel TrendPlot™
- **Digital Scope:** dual-input 20MHz oscilloscope with 1.25GS/sec. repetitive sampling rate
- **Digital Multimeter:** dual-input 5000-count True RMS meter with ohms, capacitance & temperature
- Size: 4.5"W x 2.0"D x 9.1"H • Weight: 5.8 lbs.
- **FlukeView Software (Version 3.04)**
- Documenting: transfer screens, waveforms & data to your PC for printing or importing to other programs
- Archiving: store and retrieve waveforms with text annotations and create your own library
- Analysis: gather valuable data and enable cursor measurement, extend recording of up to four user-selected measurements, upload waveforms and use cursors for detailed measurements
- Compatible with Windows® operation system

† Refurbished

Part No.	Model No.	Price
203131CD	Fluke 123S †	\$1,195.95

Fluke 124 40MHz Oscilloscope w/ 5000-Count Digital Multimeters and Paperless Recorder

The compact ScopeMeter 124 is the rugged solution for industrial troubleshooting and installation applications.

FLUKE



222421CD

It's a truly integrated test tool, with oscilloscope, multimeter and "paperless" recorder in one affordable, easy-to-use instrument. FlukeView software helps you get more out of your Scopemeter by: **(A) Documenting** by transferring waveforms, screens and measurement data from the Scopemeter to a PC; **(B) Adding** user text to individual Scopemeter settings provides guidance to the operator when recalling a set-up; **(C) Archiving** creates a library of waveforms with your comments for easy reference and comparison; **(D) Storing** complete Replay cycles for analysis of waveform changes and memory content for back-up purposes; and **(E) Analyzing** use cursors, perform spectrum analysis or export data to other analysis programs.

- Dual-input 40MHz or 20MHz digital oscilloscope
- Two 5,000-count true-RMS digital multimeters
- A dual-input TrendPlot™ recorder
- Connect-and-View™ trigger simplicity for hands-off operation • Optically isolated RS-232 interface
- Shielded test leads for oscilloscope, resistance and continuity measurements
- 10:1 Voltage Probe included for reduced circuit loading • 600 V CAT III safety certified

Part No.	Product No.	1	5
222421CD	FLK-124	\$1,494.95	\$1,419.95
222412CD	FLK124S (w/ software)	1,794.95	1,705.19

Fluke 190 Series ScopeMeters with 5000-Count Digital Multimeters, Color and B/W

For the more demanding applications, the ScopeMeter 190 Series high-performance oscilloscopes offer specifications usually found on more expensive bench instruments. With up to 200MHz bandwidth, 2.5 GS/s real-time sampling and a deep memory of 27,500 points per input; they're ideal for engineers who need the full capabilities of a high-performance oscilloscope in a handheld, battery-powered instrument.



222404CD

- Dual-input – 200 or 100MHz bandwidth
- Up to 2.5 GS/s real-time sampling per input
- Connect-and-View™ automatic triggering and a full range of manual trigger modes
- Digital Persistence for analyzing complex dynamic waveforms like on an analog scope
- Fast display update rate for seeing dynamic behavior instantaneously
- Automatic capture and replay of 100 screens
- 27,500 points per input record length using ScopeRecord mode
- TrendPlot paperless chart recorder for trend analysis up to 22 days
- Up to 1000V independently floating isolated inputs
- Waveform reference for visual comparisons and automatic pass/fail testing of waveforms
- Vpwm function for motor drive and frequency inverter applications
- 1000 V CAT II and 600 V CAT III safety certified
- Four-hour rechargeable NiMH battery pack

211220: Includes FlukeView software

Includes: Test leads, probes and manual

Part No.	Product No.	1	5
222404CD	FLK-196C (100MHz) color ..	\$2,698.95	\$2,563.95
222383CD	FLK-199C (200MHz) color ...	2,998.95	2,848.95
222391CD	FLK-199B (200MHz) B&W ...	2,698.95	2,563.95
211220CD	FLK-199B/S (200MHz) †	2,495.95	2,295.95

20MHz Digital Oscilloscope PC Card for Windows®

Dual Channel PC-Based DSO

- 20MS/s sample rate per channel
- Amplitude: max. 300V + pk
- Auto setup: 30Hz to 2MHz, 35V p-p max.
- Impedance: 1MΩ 25pF
- External trigger coupling: AC
- 8-bit resolution
- Trigger levels: ±3 div
- Trigger type: analog
- Time range: 50ns/div to 0.5s/div 1-2-5 22 step
- Input range: 50mV/div to 5V/div 1-2-5 7 step
- Two-year warranty

System requirements: IBM PC 486, Pentium® or compatible; 8MB of RAM; VGA graphics card and monitor; 8-bit ISA slot and Windows® 95/98

Includes: CD-ROM software, driver, manual and probes

Part No.	Description	1	5
153568CD	Oscilloscope card	\$214.95	\$208.95

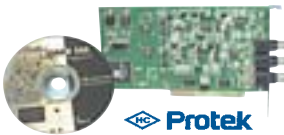

Protek
SALE

PC-MultiScope 100MHz Dual-Channel DSO

mission technology

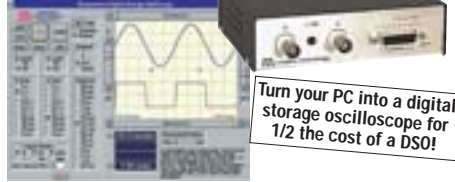

Turn your PC into a digital storage oscilloscope for 1/2 the cost of a DSO!

- 100MHz sampling; dual channel
- Chart recorder and FFT mode
- 5mV to 5V per div.; 20MHz bandwidth; ext. trigger
- 0-4MHz sine and square wave signal generator
- Triple power supply; 5VDC @ 500mA and ±0-8VDC @ 250mA
- Size: 4.3"L x 5.0"W x 1.5"H
- One-year warranty
- Weight: 3.8 lbs.

Includes: Parallel port cable, AC adapter, alligator clip probe, Windows® 3.1/95/98 software

Part No.	Description	1	10
163230CD	PC-MultiScope 3	\$579.95	\$529.95

1GHz Digital PC-Based Oscilloscope, Spectrum Analyzer and Transient Recorder

- Sampling frequency: (real-time) 1.25kHz–50MHz; (repetitive) 1GHz
- Input impedance: 1MΩ / 30pF
- Parallel Port Interface
- Inputs: 2 channels, 1 external trigger input
- Max. input voltage: 100V (AC and DC)
- Power required: 9V to 10V @ 1000mA (recommend P/N 100888CD, pg 55)



- Timebase: 20ns–100ms per division
- Input sensitivity: 5mV–15V per division with auto step-function
- Recording length: 4096 samples per channel
- Frequency range: 0 to 25MHz
- Time scale: 20ms/div–2000s/div
- Max. recording time: 9.4 hours/screen
- Max. number of samples: 100/s

System requirements: IBM compatible PC, Windows® 95/98/ME, SVGA card, mouse, printer port, CD-ROM

Includes: 2 test leads, PC parallel cable, manual and CD-ROM software

Part No.	Product No.	1	5
200184CD	PCS500	\$478.95	\$429.95

Jameco carries test leads, plugs and binding posts that are perfect for your applications!



See pages 144, 150 & 151 for our complete selection.

Pomona® 100MHz Probe Set

- Complete accessory kit included
- Attenuation: x1/x10
- Bandwidth: 15/100MHz (-3dB)
- Rise time: 23.33/3.5ns
- Input resistance: 1/10MΩ
- Capacitance: 64/10.5pF
- Compensation range: 10–60pF



Part No.	Product No.	Description	1	10
156451CD	4550B	Probe kit	\$51.95	\$46.95

PROBE MASTER® Oscilloscope Probes

Designed for use with Tektronix and Hewlett Packard oscilloscopes.

- 3 position switch: x1, ref, x10
- Bandwidth @ 3dB: 10MHz (x1); 150MHz (x10)
- Loading: 57pF, 1MegΩ (x1); 15pF, 10MegΩ (x10)
- Low-resistance gold contacts
- Cord length: 5'
- 174473CD: 7-piece kit
- 212214CD/212257CD: 25-piece kit



174473CD



Part No.	Product No.	1	10	50
174473CD	4901-02 (150MHz) ..	\$49.95	\$44.99	\$40.49
212214CD	4915 (150MHz)	149.99	142.49	142.49
212257CD	4915A (250MHz)	159.99	151.99	151.99

Modular Oscilloscope Probes



22891CD



140687CD

- 60MHz, 100MHz, 250MHz
- Hook and pointed probes
- 216047CD/140687CD: with IC test ground cover and spring ground contact
- Alligator clip ground wire
- Maximum input voltage: 600V
- BNC male connector
- Length: 5'

Part No.	Bandwidth (±3dB)		Impedance (R/C)*	
	Attenuation		Attenuation	
	x1	x10	x1	x10
22891CD	6MHz	60MHz	1MΩ/180pF	10MΩ/22pF
216047CD	6MHz	100MHz	1MΩ/47pF	10MΩ/16pF
140687CD	6MHz	250MHz	1MΩ/150pF	10MΩ/14pF

* with 20pF oscilloscope input

Part No.	Mfr. Cross Ref. No.	1	10	50
22891CD	LF101E	\$22.95	\$20.79	\$18.69
216047CD	HF-9100	34.95	29.95	26.95
140687CD	LF290	45.95	41.39	37.25

We'll match the advertised price of any like product.

Jameco's Low-Price Guarantee

It's that simple!

2-Channel, 1.5GHz Frequency Counters

- Input voltage: 115/230VAC @ 50-60Hz (switchable)
- Gate time: 0.01s, 0.1s, 1s, 10s
- 9-digit green LED display
- Size: 10.3"L x 10.0"W x 3.2"H
- One-year warranty



201873CD

Includes: Fuse, manual and BNC cable

55790CD:

- Frequency range: 0.1Hz to 150MHz (A input); 50MHz to 1.5GHz (B input)
- Resolution: 0.1nHz to 10Hz (A input); 0.1Hz to 100kHz (B input)
- Frequency, period, totalize, RPM
- Weight: 5.3 lbs.

201873CD: With Time Interval and Ratio

- Frequency range: 0.1Hz to 150MHz (A/B input); 50MHz to 1.5GHz (C input)
- Resolution: 1nHz to 10Hz
- Sensitivity: 20Vrms (A, B input); 30Vrms (C input)
- Impedance: 1MΩ < 40pF (A, B inputs); 50Ω (C input)
- Totalize, period & RPM function
- Weight: 6.0 lbs.



Part No.	Product No.	1	5
55790CD	FC-7150	\$299.95	\$259.95
201873CD	FC-7150U	342.95	325.95

2MHz & 10MHz Function Generators with Frequency Counter

Function Generator

- Wave forms: sine, square, triangle, skewed, ramp, pulse & TTL level square
- Frequency: 2Hz to 2MHz in 7 ranges (192671CD); 1Hz to 10MHz (221911CD)
- Output amplitude: 2 to 20Vpp at open load; 1 to 10Vpp at 50Ω load
- Output impedance: 50Ω ±10%
- Offset variable range (max.): ±10VDC at open load
- Frequency sweep time: 20ms to 2s



192671CD

Frequency Counter

- Measuring range: channel A: 1Hz to 20MHz; channel B: 20MHz to 2.7GHz
- Input sensitivity: channel A: 20mVRMS sinewave or 100mVp-p; channel B: 40mVRMS for 20MHz to 1.3GHz; 70mVRMS for 1.3GHz to 2.7GHz
- Max. input voltage: channel A: 35Vp-p; channel B: 3Vp-p
- Input impedance: channel A, 1MΩ; channel B, 50Ω
- Data logging and graphic software
- Size: 11.0"L x 8.2"W x 3.7"H
- Weight: 13.4 lbs.

Includes: Coax & power cable, manual, serial cable and software

Part No.	Description	1	5
192671CD	2MHz/2.7GHz	\$319.95	\$303.95
221911CD	10MHz/2.7GHz	439.95	417.95
222279CD	Software for 221911CD	12.95	12.39

Be sure your test bench has sufficient power! See page 149.



METEX® 4-in-1 Universal System

With Function Generator, Universal Counter, DC Power Supply & Digital Multimeter

- **Function generator** capable of generating seven forms of waves (sine, square, triangle, skewed sine, ramp, pulse, and TTL square wave) in seven frequency ranges from 0.2Hz to 2MHz



Save bench space & \$800!

- **Universal counter** capable of measuring frequency ranges from 5Hz to 1.3GHz
- **DC power supply** capable of generating 5V @ 2A, 15V @ 1A fixed and 0 to 30V @ 0 to 2A variable
- **Digital multimeter** with ranges of: DC voltage (400mV to 100V), AC voltage (400mV to 750V), DC/AC current (40mA to 20A), resistance (400Ω to 40MΩ), capacitance (4nF to 400μF) and forward resistance of a semiconductor junction in kΩ
- One-year warranty
- Size: 14.5"W x 14.0"D x 7.0"H
- Weight: 37 lbs.

Includes: Manual, cables and software

Part No.	Product No.	1	5
160864CD	MS9150	\$549.95	\$499.95

2MHz Function Generator

- Frequency range: 0.02Hz to 2MHz
- Waveforms: sine, triangle, square, ramp, TTL pulse, skewed sine
- Variable waveform/duty cycle symmetry
- DC offset voltage from 0 to ±10V; can be superimposed to output waveform
- Output voltage: 20Vp-p (open circuit), 10Vp-p (into 50Ω)
- Input voltage: 110V/220V 50-60Hz
- One-year manufacturer's warranty
- Size: 10.0"L x 8.0"W x 3.0"H
- Weight: 5.4 lbs.



Includes: Cord, BNC to clip cable, fuse and manual

Part No.	Product No.	1	5	10
66069CD	FG8002	\$189.95	\$179.95	\$169.95

3MHz Function Generator

- Square, triangle, and sine waves; TTL and CMOS pulse outputs
- Frequency: 0.3Hz to 3MHz in 7 ranges
- Output impedance: 50Ω ±10%
- DC offset: <-5V to >+5V into 50Ω load
- CMOS output level: 4Vpp, ±1Vpp to 14.5Vpp; ±0.5Vpp adjustable
- Variable controlled frequency input
- Variable DC offset control
- Signal polarity invert button
- Duty cycle control
- Size: 9.6"W x 11.5"D x 3.7"H
- Weight: 4.4 lbs.



Part No.	Product No.	1	5
222594CD	FG2C	\$258.95	\$245.95

5MHz Function Generator

Engineered for high reliability and user convenience.

- Waveforms: sine, square, triangle, and ramp
- 0.5 to 5MHz
- 100% DC offset
- Variable duty cycle
- Output Impedance: 50Ω
- Coarse and fine tuning
- Two-year warranty
- Size: 10.4"W x 11.7"D x 3.4"H
- Weight: 6.2 lbs.



Part No.	Prod. No.	Description	1	5
160469CD	BK4011A	0.5 to 5MHz	\$314.95	\$299.95

3MHz Sweep/Function Generator

- 6-digit green LED with 0.3" digit height
- Square, triangle, and sine waves; TTL and CMOS pulse outputs
- Frequency range: 0.3Hz to 3MHz in 7 ranges
- Impedance: 50Ω ±10%
- DC offset: <-5V to >+5V (into 50Ω load)
- CMOS output level: 4Vpp ±1Vpp to 14.5Vpp ±0.5Vpp adjustable
- Manual sweep selector operation
- Internal/external frequency counter switch selector
- Frequency counter range: 0.3Hz to 3MHz internal; 5Hz to 150MHz external
- Frequency counter impedance: 1MΩ / 150pF
- Signal polarity invert button
- Variable duty cycle
- Variable DCV offset
- Linear and logarithmic sweep
- Size: 9.6"W x 11.5"D x 3.6"H
- Weight: 4.8 lbs.



Part No.	Product No.	1	5
222586CD	FG3C	\$498.95	\$473.95

2MHz & 5MHz Sweep Function Generators with 6-Digit Frequency Counter

- Frequency range: 0.02Hz-2MHz (P/N 94676CD); 0.02Hz-5MHz (P/N 201881CD) in 7 ranges
- Sweep width: 1:1 to 100:1; rate: 20ms to 25s (5Hz-50Hz)
- Output impedance: 50Ω ±5%
- Frequency counter range: 0.2Hz to 50MHz
- Maximum input voltage: 250Vp-p
- Input voltage: 115/230VAC @ 50-60Hz (switchable)
- Size: 10.3"L x 10.0"W x 3.2"H
- Weight: 5.8 lbs.
- One-year warranty



201881CD



Includes: Probe and detachable power cord

Part No.	Prod. No.	Description	1	5
94676CD	FG7002C	2MHz Func. gen.	\$329.95	\$296.95
201881CD	FG7005C	5MHz Func. gen.	369.95	358.95

Digital Multimeter Quick Selection Guide

* See indicated page for more details on each product

All measure DC Voltage, AC Voltage, Resistance and Current, except as noted

Handheld Digital Multimeters													
Part No.	Manufacturer No.	Model No.	Features		Standard Functions			Special Functions			Unit Price		
			Display Count	Analog Bar Graph	Autorange	True RMS	Capacitance	Inductance	Frequency	Temperature		Diode Test	Logic Test
SALE	Best Sellers												
220812CD	Mastech M300	146	2000										\$12.95
119212CD	JE110	147	2000										19.95
192647CD	Wavetek/MM 10XL	143	2000										49.90
222519CD	Wavetek/MM 30XR	143	2000										59.49
220759CD	Mastech MAS830L	146	2000										15.95
220821CD	Mastech M3900	146	2000										24.95
27115CD	Metex M3800	145	2000										35.95
197958CD	Extech MV110	147	2000										38.95
220741CD	Mastech MAS838	146	2000										24.95
197966CD	Extech MV120	147	2000										59.95
192604CD	Wavetek/MM 23XT	143	2000										59.95
141250CD	BellMerit DX405	147	2000										69.95
220775CD	Mastech MY64	146	2000										45.95
177480CD	AEEC2890	147	2000										49.95
220791CD	Mastech M9508	146	2000										56.95
220783CD	Mastech M9704	146	2000										56.95
147096CD	BellMerit DX460L	147	2000										99.95
160813CD	Metex M3640D	145	2000										89.95
155491CD	Metex ME-22T	145	2000										89.95
192639CD	Wavetek/MM DM78A	143	3200										34.49
101936CD	EZ Digital DM333	147	3200										67.95
182035CD	Fluke 73-III	142	3200										148.95
192612CD	Wavetek/MM 35XL	143	3200										64.95
220767CD	Mastech MY68	146	3260										54.95
198694CD	Wavetek/MM DM73B	143	3400				(No current)						44.95
220804CD	Mastech M320	146	4000										26.95
221989CD	Metex P-09EF	144	4000										39.95
192583CD	Wavetek/MM AC40A	150	4000				(No DC current)						74.95
222501CD	Wavetek/MM DM9	143	4000										39.49
221971CD	Metex P-10	144	4000										39.95
216514CD	Metex ME-31	145	4000										59.95
222308CD	Metex ME-32	145	4000										79.95
220724CD	Wavetek/MM 34XR	143	4000										108.95
211650CD	Extech MN26	147	4000										39.95
222535CD	Wavetek/MM 33XR	143	4000										89.49
221997CD	Metex M3270D	144	4000										89.95
216522CD	Metex ME-32F	145	4000										79.95
215589CD	Metex M3890D	154	4000										99.95
117372CD	Metex M3850D	145	4000										109.95
137461CD	Metex M3860D	145	4000										149.95
190967CD	Fluke 110 (No I)	142	6000										108.95
190975CD	Fluke 111	142	6000										128.95
185527CD	Fluke 112	142	6000										148.95
192655CD	Fluke 175	142	6000										168.95
192663CD	Fluke 177	142	6000										193.95
185535CD	Fluke 179	142	6000										208.95
222560CD	Wavetek/MM HD160B	143	10,000										229.49
222527CD	Wavetek/MM 37XR	144	10,000										129.49
222543CD	Wavetek/MM 38XR	144	10,000										149.49
136590CD	Mastech MY65	146	20,000										69.95
144872CD	Metex M4640A	145	20,000										139.95
222375CD	Fluke 187	142	50,000										378.95
185201CD	B&K BK5380	147	50,000										149.99
182043CD	Fluke 189	142	50,000										398.95

Fluke 73 Series III 3200-Count Analog/Digital Multimeter

- 3200-count digital display with 31 segment analog bar graph
- Cat II 600V rating with overvoltage protection
- Automatic touch hold
- Default auto range mode
- Resolution: 100µV maximum
- DC/AC voltage ranges: 320mV – 600V
- DC/AC current ranges: 320mA – 10A
- Resistance ranges: 320Ω – 32MΩ
- Diode and continuity test
- Weight: 2.0 lbs.



Part No.	Model No.	1	5
182035CD	Fluke 73 III	\$148.95	\$138.95

Fluke 110 Series 6000-Count Digital Multimeters

- Basic DC accuracy of 0.7%
- True RMS reading
- Min./max./average functions
- CAT III 600V rated
- Resolution: 1mV maximum
- DC/AC voltage ranges: 6V – 600V
- Resistance ranges: 600Ω – 40MΩ
- Also capacitance, frequency and continuity
- Weight: 1.3 lbs.
- Size: 11.8"L x 7.0"W x 3.0"H
- Backlight display



Part No.	Model No.	AC current	DC current	1	10
190967CD	Fluke 110	—	—	\$108.95	\$103.49
190975CD	Fluke 111	10A	6A/10A	128.95	122.95
185527CD	Fluke 112	10A	6A/10A	148.95	141.95

Fluke 175/177/179 6000-Count Digital Multimeters

- Min./max./average functions
- Auto hold and manual hold
- IEC 1010 rating Cat IV 600V/ Cat III 1000V
- Resolution: 100µV maximum
- DC/AC voltage ranges: 600mV – 1000V
- DC/AC current ranges: 60mA – 10A
- Resistance ranges: 600Ω – 50MΩ
- Also capacitance and frequency
- Size: 6.3"L x 3.3"W x 9.2"H
- Weight: 1.5 lbs.
- Temperature: -40 to +400°C

True RMS



Part No.	Model No.	DC Accuracy	1	5
192655CD	Fluke 175	0.15%	\$168.95	\$159.95
192663CD	Fluke 177	0.09%	193.95	184.95
185535CD	Fluke 179	0.09%	208.95	198.49

Fluke 187/189 50,000-Count Multimeters

- Digital and analog bar graph display
- Backlight with 2 brightness levels
- Fast auto range
- AC/DC true RMS
- Resolution: 1µV maximum
- Resistance range: 500Ω – 500MΩ
- DC/AC voltage ranges: 50mV – 1000V
- DC/AC current ranges: 500µA – 10A
- Also capacitance, frequency & temp.
- Conductance, diode testing and continuity functions
- Wt.: 2.0 lbs.
- Data logging: 288 intervals stored; 100 readings (182043CD only)
- Size: 8.0"L x 3.9"W x 2.0" Thick



Part No.	Model No.	Resistance Ranges	1	5
222375CD	Fluke 187	500Ω-500MΩ	\$378.95	\$359.95
182043CD	Fluke 189	500Ω-500MΩ	398.95	378.95

Test Lead Kits see page 144

7-Function 2000-Count Multimeter



- Unique voltage Safety Tester™
- 7 function/22 ranges & 6 range volt tester
- Large 17mm (.67") display
- Resolution: 0.1mV maximum
- DC voltage ranges: 200mV – 1000V
- AC voltage ranges: 200V – 750V
- DC current ranges: 200µA – 10A
- Resistance ranges: 200Ω – 20MΩ
- Safety tester: 6, 12, 24, 50, 110 and 220 volts
- Diode test and continuity beeper
- Size: 2.8"W x 1.3"D x 6.1"H • One-year warranty



Part No.	Model No.	1	10	25
192647CD	10XL	\$49.90	\$47.45	\$44.95

5-Function 3200-Count Pocket Multitester



- 5 functions, 15 ranges
- 3 1/4-digit LCD display w/ bargraph
- Resolution: 100µV maximum
- DC voltage ranges: 320mV – 450V
- AC voltage ranges: 3.2V – 450V
- Resistance ranges: 320Ω – 32MΩ
- Diode and continuity test
- Auto power off for longer battery life
- CAT I 600V, CAT II 300V rated • Data hold
- Size: 2.2"W x 0.4"D x 4.3"H • Weight: 0.2 lbs.

Includes: Manual, case and battery

Part No.	Product No.	1	10
192639CD	DM78A	\$34.49	\$32.79

11-Function 4000-Count Multimeter



- 11 functions/32 ranges
- Resolution: 100µV maximum
- DC voltage ranges: 400mV – 1000V
- AC voltage ranges: 400mV – 750V
- DC/AC current ranges: 400µA – 10A
- Resistance ranges: 400Ω – 40MΩ
- Capacitance ranges: 4µF – 4000µF
- Temperature ranges: -20°C to 1000°C (-4°F to 1832°F) • Auto power off
- Frequency: 4kHz – 40MHz
- Duty cycle & continuity test • Holster with strap
- MIN./MAX., data hold and range lock
- CAT III 600V, CAT II 1000V • Weight: 1.0 lb.
- Size: 7.8"W x 3.6"D x 2.4"H • Three-year warranty

Part No.	Model No.	1	10	25
220724CD	34XR	\$108.95	\$103.55	\$103.55

2000-Count Multimeter With Non-Contact Voltage & Battery Tester

- 9 functions, 26 ranges
- 3 1/2-digit LCD display
- Resolution: 100µV maximum
- DC/AC voltage ranges: 200mV – 600V
- DC/AC current ranges: 200µA – 10A
- Resistance ranges: 200Ω – 20MΩ
- Battery tester ranges: 1.5V – 9V
- Non-contact voltage detector ranges: 70VAC – 600VAC
- Diode and continuity test
- Min/Max, data hold
- CAT III 300V, CAT II 600V rated
- Size: 3.5"W x 2.4"D x 7.7"H
- Weight: 1.0 lb.



Includes: Spare fuse, test leads, and 9V battery

Part No.	Product No.	1	5
222519CD	30XR	\$59.49	\$56.49

8-Function 3200-Count Multimeter

- 8 functions/26 ranges
- Digital & analog bar graph display
- Long 1000 hour battery life with auto off for power saving
- Resolution: 0.1mV maximum
- DC voltage ranges: 320mV – 600V
- AC voltage ranges: 3.2V – 600V
- DC current ranges: 320µA – 10A
- AC current ranges: 320µA – 10A
- Resistance ranges: 320Ω – 32MΩ
- Capacitance ranges: 32µF – 32mF
- Diode test and continuity beeper
- Size: 2.8"W x 1.3"D x 6.1"H • Data hold
- One-year warranty



Part No.	Model No.	1	10
192612CD	35XL	\$64.95	\$58.49

8-Function 4000-Count Multimeter with Battery Tester

- 8 functions, 19 ranges
- 3 1/4-digit LCD display
- Resolution: 1mV maximum
- DC/AC voltage ranges: 4V – 600V
- DC/AC current ranges: 400mA
- Resistance ranges: 4000Ω – 40MΩ
- Battery tester ranges: 1.5V – 9.0V
- Diode and continuity test
- Auto ranging
- Special ranges to test household batteries with Go/NoGo LED
- CAT II 600V rated
- Size: 3.1"W x 1.6"D x 5.5"H
- Weight: 0.6 lbs.



Includes: Spare fuse, test leads, and 9V battery

Part No.	Product No.	1	5
222501CD	DM9	\$39.49	\$37.49

4000-Count Multimeter with Temperature, Capacitance and Frequency Measurements

- 3 1/4-digit LCD display with 41-segment analog bargraph
- 10 functions, 33 ranges
- Resolution: 100µV maximum
- DC voltage ranges: 400mV – 1000V
- AC voltage ranges: 400mV – 750V
- DC/AC current ranges: 400µA – 10A
- Resistance ranges: 400Ω – 4MΩ
- Capacitance ranges: 4µF – 4000µF
- Temperature ranges: -20°C to 1000°C (-4°F to 1832°F)
- Frequency ranges (auto-ranging): 4kHz – 40MHz
- Diode and continuity test
- Auto power off to save battery life
- Input warning tone when test leads are in wrong jack
- CAT III 600V, CAT II 1000V rated
- Min/Max, relative, peak and data hold
- Size: 3.5"W x 2.3"D x 7.7"H • Weight: 0.9 lbs.



Includes: Spare fuse, test leads and 9V battery

Part No.	Product No.	1	5
222535CD	33XR	\$89.49	\$84.99

7-Function 10,000-Count Heavy-Duty Multimeter

- 7 functions, 19 ranges
- 4-digit LCD display with bargraph
- Resolution: 100µV maximum
- DC voltage ranges: 1V – 1500V
- AC voltage ranges: 10V – 1000V
- DC/AC current ranges: 10mA – 10A
- Resistance ranges: 1kΩ – 40MΩ
- Diode and continuity test
- Auto ranging
- True RMS measuring
- Unique live voltage Safety Tester
- Special sealing for environment and water proofing
- CAT III 1000V rated
- Size: 3.9"W x 2.3"D x 8.8"H • Weight: 1.4 lbs.



Includes: Spare fuse, test leads, and 9V battery

Part No.	Product No.	1	5
222560CD	HD160B	\$229.49	\$217.99

10-Function 2000-Count Multimeter

- 10 functions/28 ranges & 4 voltage testers
- Unique voltage Safety Tester®
- Resolution: 0.1mV maximum
- DC voltage ranges: 200mV – 1000V
- AC voltage ranges: 200mV – 750V
- DC/AC current ranges: 200µA – 10A
- Resistance ranges: 200Ω – 2000MΩ
- Temperature: -20° to 750°C (-4° to 1400°F)
- NPN/PNP transistor, TTL/CMOS logic and diode test
- Size: 3.1"W x 1.5"D x 7.2"H
- Data hold
- Continuity beeper



Part No.	Model No.	1	10	25
192604CD	23XT	\$59.95	\$50.99	\$38.25

Log on Today! www.Jameco.com

4200-Count Probe-Style Pen Meter

- Unique "Pen" Style DMM that allows easy, one-hand operation
- Auto power off
- Resistance ranges: 340Ω – 34MΩ
- VAC ranges: 3.4V – 600V
- Superior 0.5% accuracy
- Size: 1.4"W x 1.1"D x 7.8"H
- Resolution: 0.1mV max.
- VDC ranges: 340mV – 600V
- Analog bar graph
- Continuity beeper
- One-year warranty



SALE

Includes: Alligator clip, ground test lead, spare probe tip and batteries

Part No.	Model No.	Size (WxDxH)	1	10
198694CD	DM73B	1.4" x 1.1" x 7.8"	\$44.95	\$41.49



Test Equipment

10,000-Count True RMS Multimeter with Decibel Measurement, Component and Logic Test

- 13 functions, 42 ranges
- 4-digit LCD display with 41-segment analog bargraph
- Resolution: 100µV maximum
- **DC voltage ranges:** 1000mV – 1000V
- **AC voltage ranges:** 1000mV – 750V
- **DC/AC current ranges:** 100µA – 10A
- **Resistance ranges:** 1000Ω – 40MΩ
- **Capacitance ranges:** 40nF – 400µF
- **Inductance ranges:** 4mH – 40H
- **Frequency ranges:** 100Hz – 10MHz
- **Decibel ranges:** -13dBm - +50dBm
- Duty Cycle: 0% to 90%
- Logic, continuity, diode test
- Input warning tone when test leads are in wrong jack
- Min/Max, average, relative, peak, and data hold
- True RMS
- Auto power off to save battery life
- CAT III 600V and CAT II 1000V rated
- Size: 7.8"H x 3.6"W x 2.4"D • Weight: 1.0 lb.



Includes: Spare fuse, test leads, and 9V battery

Part No.	Product No.	1	5
222527CD	37XR	\$129.49	\$122.99

13-Function 10,000-Count True RMS Multimeter

- 13 functions, 43 ranges
- 4-digit LCD display with 41-segment analog bargraph
- Resolution: 100µV maximum
- **DC voltage ranges:** 1000mV – 1000V
- **AC voltage ranges (True RMS):** 1000mV – 750V
- **AC/DC voltage ranges:** 1000mV – 750V
- **DC/AC current ranges:** 100µA – 10A
- **Resistance ranges:** 1000Ω – 40MΩ
- **Capacitance ranges:** 40nF – 400µF
- **Temperature ranges:** -20°C - +1300°C (-4°F - +2372°F)
- **Frequency ranges:** 100Hz – 10MHz
- **Decibel ranges:** -13dBm - +50dBm
- Diode and continuity test
- Duty Cycle: 0% to 90%
- Min/Max, average, relative, peak and data hold
- Auto power off and auto-ranging
- Input lead warning
- Optical PC interface (P/N 222551CD): with the optional software and RS-232 cable, the multimeter can be used for real-time data acquisition using any industry standard Windows® PC
- CAT IV 600V, CAT III 1000V rated
- Size: 7.8"H x 3.6"W x 2.4"D
- Weight: 1.0 lb.



Includes: Test leads with threaded alligator clips, temperature adaptor, K-type thermocouple, 9V battery, spare fuse, and manual

Part No.	Product No.	1	5
222543CD	38XR	\$149.49	\$141.99
222551CD	38SW (software/cable)	19.49	18.49

Test Lead Kits

214332CD:
Wavetek Metertek Basic DMM Test Lead Kit

- Silicone lead wires, 48" long, red and black
- Standard probe tips, red and black
- Alligator clips, red and black
- Spade lugs, red and black



214332CD

222471CD:
Wavetek Metertek Deluxe DMM Test Lead Kit

- Silicone lead wires, 48" long, red and black
- Standard probe tips, red and black
- Alligator clips, red and black
- Spade lugs, red and black
- Spring loaded crimp tips, red and black
- Red tip length extender



222471CD

222463CD: Fluke Deluxe Electronic Test Lead Kit

Recommended for use in low energy, electronic test applications that require fine probing easily achievable with larger industrial probes. CAT III 300V rated. Compatible with Fluke and other multimeters that accept safety shrouded, standard diameter banana connectors.



222463CD

One pair (red & black) of each of the following:

- One meter long test lead with a safety shrouded, right angle banana connector on one end and a stainless steel test probe on the other end
- Insulated probe tip extender
- Modular test probe w/ banana connector in handle
- Modular hook-style clip test lead w/ banana connector
- Modular pinch-style clip test lead with banana connector • Insulated alligator clip
- Modular alligator clip with banana connector
- Slide-on IC probe tip adapter and test lead couplers
- Bare spade lug with banana connector

222455CD: Fluke Basic Electronic Test Lead Kit

One pair (red & black) of each of the following:

- One meter long test lead with a safety shrouded, right angle banana connector on one end and a stainless steel test probe on the other end
- Insulated probe tip extender
- Insulated alligator clip



222455CD

222447CD: Fluke SureGrip Industrial Test Lead Kit

- 1000 V CAT III, 600 V CAT IV rated.
- Includes:** one pair (red and black):
 - AC220 Insulated Alligator Clips: nickel plated jaws grip objects up to 3/8" (9.5mm); Blunt tip grabs round screw heads
 - TP220 Industrial Test probes: Sharp, 1/2" (12mm) stainless steel tip provides reliable contact; Flexible finger barrier improves grip
 - TL222 Industrial Right Angle Test leads: 1.5 meter silicone insulated wire resists heat and cold; superior strain relief



222447CD

Part No.	Product No.	1	5
214332CD	DL243C	\$34.49	\$32.79
222471CD	DL248C	57.49	54.59
222463CD	TL81A	98.95	93.95
222455CD	TL80A	38.95	36.95
222447CD	TL220	44.95	42.69

4000-Count Pocket Multimeters

- 3½-digit LCD display with 0.46" digit height
- Resolution: 100uV maximum
- Diode test
- Continuity buzzer
- Battery check
- Built-in test leads and battery
- Auto ranging and auto polarity indication
- Size: 4.6"H x 2.9"W x 0.7"D



221971CD

- 221971:**
- 10 functions, 13 ranges
 - **DC voltage ranges:** 400mV – 400V
 - **AC voltage ranges:** 4V – 400V
 - **DC/AC current ranges:** 400µA – 400mA
 - **Resistance ranges:** 400Ω – 40MΩ
 - **Frequency ranges:** 10Hz – 10MHz
 - **Capacitance ranges:** 40nF – 40µF
 - Duty measurement of 100%



221989CD

- 221989:**
- 6 functions, 7 ranges
 - **DC/AC voltage ranges:** 400mV – 400V
 - **DC current ranges:** 400mA
 - **Resistance ranges:** 400Ω – 40MΩ
 - **Electric Field Test ranges:** 50VAC – 400VAC, 50-60Hz

Part No.	Product No.	1	10	25
221971CD	P-10	\$39.95	\$37.95	\$35.95
221989CD	P-09EF	39.95	37.95	35.95

4000-Count Multimeter With Dual Display and Bargraph

- 10 functions, 16 ranges
- 3½-digit LCD display with 43-segment bargraph and dual display
- Resolution: 100µV maximum
- **DC voltage ranges:** 400mV – 1000V
- **AC voltage ranges:** 4V – 750V
- **DC/AC current ranges:** 400µA – 20A
- **Resistance ranges:** 400Ω – 40MΩ
- **Capacitance ranges:** 4nF – 400µF
- **Frequency ranges:** 4kHz – 4MHz
- Diode, continuity, h_{FE} test
- Dual display for related readings
- Data-hold, range-hold, auto/min/max-hold and relative offset
- Memory and recall for 10 values
- Auto-ranging and auto polarity indication
- Size: 7.1"H x 3.3"W x 1.3"D



Includes: test leads and battery

Part No.	Product No.	1	10
221997CD	M-3270D	\$89.95	\$85.49

30-Day Money-Back Guarantee

If you're not satisfied, we'll take it back!
Details on page 217.

METEX® 2000-Count Multimeter

0.6" Digit Height • LCD Readout

- Resolution: 100µV maximum
- DC voltage ranges: 200mV – 1000V
- AC voltage ranges: 200mV – 700V
- DC/AC current ranges: 20µA – 20A
- Resistance ranges: 200Ω – 20MΩ
- Diode test and continuity beeper
- Auto zeroing
- Input impedance: 10MΩ
- Surge protection up to 3kV
- See page 150 for compatible leads (P/Ns: 77745CD, 21856CD, 21864CD)
- Size: 3.5"W x 1.3"D x 6.8"H
- Weight: 1.2 lbs.
- One-year warranty



SALE



Includes: Probes, carrying case, manual & 9V battery

Part No.	Product No.	1	10	50
27115CD	M3800	\$35.95	\$32.49	\$29.95

4000-Count Multimeter with RS-232 and Analog Bar

- 3½-digit LCD display with analog bar (0.6" digit height)
- RS-232 computer interface
- Automatic polarity indication
- Data hold/range hold function
- Resolution: 100µV maximum
- DC voltage ranges: 400mV-1000V
- AC voltage ranges: 400mV-750V
- DC/AC current ranges: 4mA-20A
- Resistance ranges: 400Ω-4MΩ
- Diode and continuity test
- Size: 3.3"W x 1.5"D x 7.3"H
- Weight: 1.9 lbs.



METEX®

Includes: Probes, 9V battery, software, RS-232 cable and manual

Part No.	Model No.	1	10
216514CD	ME-31	\$59.95	\$53.95

4000-Count Multimeter w/ RS-232, Dual Display, Inductance & True RMS

- Dual displays for comparative measurements
- 3½-digit LCD (0.63" digit height)
- True RMS
- Resolution: 100µV maximum
- DC voltage ranges: 400mV - 1000V
- AC voltage ranges: 400mV – 750V
- DC/AC current ranges: 400µA – 20A
- Resistance ranges: 400Ω – 40MΩ
- Temperature: -40°C to +1200°C; 1°C resolution
- Weight: 1.9 lbs.
- Measures inductance, capacitance, transistor h_{FE} and frequency
- Computer interface (RS-232C) w/ software & cable
- Autoranging all measurement settings
- Size: 3.3"W x 1.8"D x 7.2"H
- One-year warranty



METEX®

Includes: 9V battery and software

Part No.	Product No.	1	10
137461CD	M3860D	\$149.95	\$134.99

2000-Count Multimeter w/ RS-232, Analog Bar and Temperature

- 3½-digit LCD (.65" digit height) with analog bar
- Data hold
- RS-232C computer interface
- True RMS
- Resolution: 100µV maximum
- DC voltage ranges: 200mV – 1000V
- AC voltage ranges: 200mV – 750V
- DC/AC current ranges: 2mA – 20A
- Resistance ranges: 200Ω – 2000MΩ
- Frequency ranges: 2kHz – 20MHz
- Temperature: -40°C to +1200°C @ 1°C resolution
- Diode, transistor h_{FE} and logic test and continuity test
- One-year warranty
- Size: 3.0"W x 1.5"D x 7.2"H
- Weight: 1.9 lbs.



METEX®

Includes: Operating manual, probes, K-type thermocouple, 9V battery and software

Part No.	Product No.	1	10	25
155491CD	ME-22T	\$89.95	\$79.95	\$71.95

4000-Count Multimeters w/ RS-232, Analog Bar and Temperature

- 3½-digit LCD display (0.6" digit height) with bargraph
- Automatic polarity indicator
- Range hold function
- RS-232 computer interface
- Resolution: 100µV max.
- DC voltage ranges: 400mV – 1000V
- AC voltage ranges: 400mV – 750V
- DC/AC current ranges: 4mA – 20A
- Resistance ranges: 400Ω – 4MΩ
- Capacitance ranges: 4nF – 400nF
- Temperature ranges: -4°F – 2000°F
- Continuity, diode and transistor h_{FE} test
- Size: 3.2"W x 1.5"D x 7.3"H
- Weight: 1.7 lbs.
- 222308CD: same as above except with temperature measurement in °C only



216522CD (reading in °F only)

Includes: Probes, K-type temperature probe, software, 9V battery and manual

Part No.	Model No.	Description	1	10
216522CD	ME-32F	°F	\$79.95	\$69.95
222308CD	ME-32	°C	79.95	75.95

4000-Count Multimeter w/ RS-232, Temperature & Autorange

- 3½-digit LCD (0.63" digit height)
- RS-232C computer interface
- Resolution: 100µV max.
- DC voltage ranges: 400mV – 1000V
- AC voltage ranges: 400mV – 750V
- DC/AC current ranges: 400µA – 20A
- Resistance ranges: 400Ω – 40MΩ
- Temperature: -40°C to +1200°C
- Diodes and continuity
- Measures transistor h_{FE}, frequency, and capacitance
- Autoranging all scale settings
- One-year warranty
- Size: 3.3"W x 1.8"D x 7.2"H
- Weight: 1.8 lbs.



METEX®

Includes: Manual, software, RS-232 interface cable, temperature probe and probes

Part No.	Product No.	1	10	25
117372CD	M3850D	\$109.95	\$99.95	\$89.95

20,000-Count Multimeter w/ RS-232 & Multi-Display

- 0.63" digit height
- LCD readout
- Multi-display: 4 simultaneous displays for relative and comparative measurements
- Resolution: 10µV maximum
- DC voltage ranges: 200mV – 1000V
- AC voltage ranges: 200mV – 750V
- DC/AC current ranges: 2mA – 20A
- Resistance ranges: 200Ω – 20MΩ
- Capacitance ranges: 20nF – 200µF
- Frequency ranges: 20kHz – 2MHz
- Diode/continuity: measures forward resistance of a semiconductor junction in kΩ a test current of approximately 1mA
- Measures transistor h_{FE}
- Size: 3.3"W x 1.5"D x 7.5"H
- Weight: 2.0 lbs.
- LCD size: 2.4"W x 1.3"H
- One-year warranty



METEX®

Includes: Software, test leads, PC interface cable, manual and 9V battery

Part No.	Product No.	1	10
144872CD	M4640A	\$139.95	\$125.95

Don't worry about backorders. Over 99% of our products are in stock!

We'll Send It Today!

Just place your order by 6PM EST for same business day shipment

2000-Count Multimeter w/ RS-232 & Dual Display

- Dual displays for comparative measurements
- 3½-digit LCD w/ 2000 counts (.65" digit height)
- Auto/min/max/data hold function
- Resolution: 100µV maximum
- DC voltage ranges: 200mV – 1000V
- AC voltage ranges: 200mV – 750V
- DC/AC current ranges: 2mA – 20A
- Resistance ranges: 200Ω – 2000MΩ
- Tests continuity, diode, transistor h_{FE}, frequency, capacitance and temperature
- Size: 3.2"W x 1.2"D x 7.1"H
- Weight: 1.8 lbs.
- One-year warranty



METEX®

Includes: PC interface cable, probes, temperature probe, manual, software and 9V battery

Part No.	Product No.	1	10	25
160813CD	M3640D	\$89.95	\$84.95	\$79.95

Extremely Low Cost 7-Function 2000-Count Multimeter

- 3½-digit LCD display (0.5" digit height)
- Resolution: 100µV maximum
- DC voltage ranges: 200mV - 500V
- AC voltage ranges: up to 500V
- DC current ranges: 200µA - 10A
- Resistance ranges: 200Ω - 2000kΩ
- Diode, continuity and transistor h_{FE} test
- Size: 5.0"H x 2.7"W x 1.0"D



Part No.	Product No.	1	10	25
220855CD	M830B	\$9.95	\$9.45	\$8.99

2000-Count Auto-Range Pocket Multimeter

- 3½-digit LCD display (0.43" digit height)
- Resolution: 100µV maximum
- DC voltage ranges: 2V - 500V
- AC voltage ranges: 200V - 500V
- DC current ranges: 200mA
- Resistance ranges: 2kΩ - 2000kΩ
- Diode and continuity test
- Size: 4.7"H x 2.7"W x 0.8"D



Part No.	Product No.	1	10	25
220812CD	M300	\$12.95	\$12.29	\$11.69

8-Function 2000-Count Multimeter

- 8-functions/30 ranges
- 3½-digit LCD display (0.8" digit height)
- Resolution: 100µV maximum
- DC voltage ranges: 200mV - 1000V
- AC voltage ranges: 200mV - 700V
- DC/AC current ranges: 20µA - 10A
- Resistance ranges: 200Ω - 20MΩ
- Diode, continuity and transistor h_{FE} test
- CAT II 1000V and CAT III 600V rated
- Size: 6.8"H x 3.4"W x 1.3"D



Part No.	Product No.	1	10	25
220821CD	M3900	\$24.95	\$23.69	\$22.55

2000-Count Multimeter w/ Frequency & Temperature Measurements

- 3½-digit LCD display (1.0" digit height)
- Resolution: 100µV maximum
- DC voltage ranges: 200mV - 1000V
- AC voltage ranges: 200mV - 700V
- DC/AC current ranges: 200µA - 10A
- Resistance ranges: 200Ω - 200MΩ
- Capacitance ranges: 2nF - 20µF
- Frequency range: up to 20kHz
- Temperature ranges: -20°C - +1000°C
- Diode, continuity, and transistor h_{FE} test
- Tilting LCD display • Hold data button
- Size: 8.0"H x 4.0"W x 1.8"D



Part No.	Product No.	1	10	25
220791CD	M9508	\$56.95	\$54.15	\$51.45

2000-Count Multimeter w/ Temperature Measurement

- 8 function/17 ranges
- 2000-count 3½-digit LCD display (0.6" digit height)
- Resolution: 100µV maximum
- DC voltage ranges: 200mV - 600V
- AC voltage ranges: 200V - 600V
- DC current ranges: 2mA - 10A
- Resistance ranges: 200Ω - 2MΩ
- Temperature ranges: -20°C - +1000°C
- Diode, transistor h_{FE}, and continuity test
- Data hold switch
- Size: 5.7"H x 3.0"W x 1.4"D



Includes: Test leads, and temperature probe

Part No.	Product No.	1	10	25
220741CD	MAS838	\$24.95	\$23.69	\$22.49

2000-Count Multimeter With Diode and h_{FE} Test

- 2000-count 3½-digit LCD display (0.6" digit height)
- 7 function/17 ranges
- Resolution: 100µV maximum
- DC voltage ranges: 200mV - 600V
- AC voltage ranges: 200V - 600V
- DC current ranges: 200µA - 10A
- Resistance ranges: 200Ω - 2MΩ
- Diode, continuity, and transistor h_{FE} test
- Data hold switch & backlight button
- Size: 5.7"H x 3.0"W x 1.4"D



Part No.	Product No.	1	10	25
220759CD	MAS830L	\$15.95	\$15.15	\$14.39

2000-Count Multimeter w/ Digital & Analog Pointer Display, Frequency & Temperature Measurements

- 3½-digit LCD display (0.7" digit height) with analog pointer
- Resolution: 100µV maximum
- DC/AC voltage ranges: 200mV - 600V
- DC/AC current ranges: 2mA - 200mA
- Resistance ranges: 200Ω - 20MΩ
- Capacitance ranges: 2nF - 20µF
- Frequency ranges: up to 20kHz
- Temperature ranges: -20°C to +1000°C
- Diode, continuity, and transistor h_{FE} test
- Zero adjustment knob for analog pointer display
- Built-in test leads • Size: 7.6"H x 4.0"W x 1.5"D



Part No.	Product No.	1	10	25
220783CD	M9704	\$56.95	\$54.15	\$51.45

We'll match the advertised price of any like product.

Jameco's Low-Price Guarantee

It's that simple!

2000-Count Multimeter w/ Temperature & Frequency Measurements

- 11 functions/33 ranges
- 2000-count LCD display with 1" digit height
- Resolution: 100µV max.
- DC voltage ranges: 200mV - 1000V
- AC voltage ranges: 200mV - 700V
- DC/AC current ranges: 2mA - 10A
- Resistance ranges: 200Ω - 200MΩ
- Capacitance ranges: 2nF - 20µF
- Frequency ranges: 2kHz - 20kHz
- Temperature ranges: -20°C - +1000°C
- Diode, continuity, and transistor h_{FE} test



Includes: Test leads and K-type thermocouple

Part No.	Product No.	1	10	25
220775CD	MY64	\$45.95	\$43.65	\$41.45

3260-Count Multimeter with Analog Bargraph & Frequency Measurements

- 10-functions/29 ranges
- 3260-count 0.67" digit height LCD display with analog bar graph
- Resolution: 100µV maximum
- DC voltage ranges: 326mV - 1000V
- AC voltage ranges: 3.26V - 750V
- DC/AC current ranges: 326µA - 10A
- Resistance ranges: 326Ω - 32.6MΩ
- Capacitance ranges: 326nF - 32.6µF
- Frequency ranges: 32.6kHz - 150kHz
- Diode, continuity, and transistor h_{FE} test
- Auto range and data hold push button



Part No.	Product No.	1	10	25
220767CD	MY68	\$54.95	\$52.25	\$49.65

4000-Count Auto-Range Pocket Multimeter

- 3¾-digit LCD display (0.43" digit height)
- Resolution: 100µV maximum
- DC/AC voltage ranges: 4V - 500V
- DC/AC current ranges: 40mA - 400mA
- Resistance ranges: 400Ω - 40MΩ
- Diode and continuity test
- Size: 4.8"H x 2.7"W x 0.8"D
- Data hold button
- Built-in test leads



Part No.	Product No.	1	10	25
220804CD	M320	\$26.95	\$25.65	\$24.35

Our Lowest Priced 20,000-Count Multimeter

- Extra-large digits (0.8" digit height)
- Resolution: 10µV maximum
- DC voltage ranges: 200mV - 1000V
- AC voltage ranges: 2V - 700V
- DC/AC current ranges: 2mA - 10A
- Resistance ranges: 200Ω - 200MΩ
- Capacitance ranges: 200pF - 20µF
- Measures transistor h_{FE} & continuity
- Hold button • Auto power off
- Size: 3.9"W x 1.9"D x 8.0"H
- Weight: 1.5 lbs. • One-year warranty



Part No.	Product No.	1	10	25
136590CD	MY65	\$69.95	\$62.95	\$56.95

Comparison table for all DMMS - see page 142

2000-Count Pocket Multimeter

- DC voltage ranges: 200mV, 2V, 20V, 200V, 1000V
- AC voltage ranges: 200V, 750V
- DC current ranges: 200µA, 2mA, 20mA, 200mA, 10A
- Resistance ranges: 200Ω, 2kΩ, 20kΩ, 200kΩ, 2MΩ
- Diode, transistor and audible continuity tests
- 0.5" digit height
- Removable test leads
- One-year warranty
- Size: 2.6"W x 1.0"D x 4.8"H
- Weight: 0.5 lbs.



Includes: 9V battery

Part No.	Description	1	10	50
119212CD	Pocket multimeter	\$19.95	\$17.95	\$16.19

2000-Count Multimeter with Temperature & Frequency Measurement

- 3½-digit LCD (1.0" digit height)
- Resolution: 100µV maximum
- DC voltage ranges: 200mV - 1000V
- AC voltage ranges: 2V - 700V
- DC current ranges: 2mA - 10A
- AC current ranges: 200mA - 10A
- Resistance ranges: 200Ω - 20MΩ
- Capacitance ranges: 2nF - 20µF
- Frequency: 20kHz
- Temperature range: -20°C - 1000°C
- Diode, transistor and continuity testing
- Data hold switch
- Size: 4.0"W x 2.0"D x 8.0"H • Weight: 1.6 lbs.



Includes: Manual, probes, and 9V battery

Part No.	Mfr. Cross Ref. No.	1	10
177480CD	AEEC2890	\$49.95	\$44.95

Autoranging 3200-Count Analog/Digital Multimeter

- 3¼-digit (0.53" digit height) LCD with analog bar graph
- Resolution: 100µV maximum
- DC voltage ranges: 320mV - 1000V
- AC voltage ranges: 320mV - 750V
- DC/AC current ranges: 320µA to 10A
- Resistance ranges: 320Ω - 32.59MΩ
- Data hold
- Diode/continuity test
- Auto range
- Auto power off
- Size: 3.9"W x 1.5"D x 7.7"H • Weight: 1.5 lbs.



EZ DIGITAL

Part No.	Mfr. Cross Ref. No.	1	10
101936CD	DM333	\$67.95	\$59.95

2000-Count Multimeters

- Function and range annunciators
- Resolution: 100µV max.
- Data hold
- DC voltage ranges: 200mV - 1000V
- DC/AC current ranges: 200µA - 10A
- Frequency ranges: 2kHz - 20MHz
- AC voltage ranges: 200mV - 750V
- Resistance ranges: 200Ω - 20MΩ
- Diode and continuity test h_{FE}
- Auto power off
- Z_{IN} = 10MΩ
- 141250CD: Basic model with transistor test h_{FE}
- Capacitance: 2nF - 20µF
- Size: 4.0"W x 2.3"D x 8.0"H
- 147096CD: Basic model with transistor test h_{FE}
- Capacitance: 2nF - 2000µF
- Inductance: 20mH - 20H
- Size: 4.0"W x 1.5"D x 8.0"H



SALE

BelMERIT



141250CD



147096CD

Includes: Manual, test probes and 9V battery

Part No.	Description	Wt. (lbs.)	1	10
141250CD	Meter w/ h _{FE}	1.5	\$69.95	\$62.95
147096CD	Meter w/ inductance	2.7	\$99.95	\$89.95

2000-Count Multimeters w/ Adjustable Viewing Angle

- Adjustable 1" LCD display for better viewing
- Auto power-off
- Improper test lead position alarm alerts user if position does not match function
- Accuracy: ±0.5% for DCV
- Resolution: 100µV maximum
- DC voltage ranges: 200mV - 1000V
- AC voltage ranges: 200mV - 750V
- DC/AC current ranges: (P/N 197958CD) 20µA - 10A; (P/N 197966CD) 20mA - 20A
- Resistance ranges: 200Ω - 200MΩ
- Tests diode, continuity and transistor h_{FE}
- Size: 3.5"W x 1.3"D x 7.3"H
- Weight: 0.6 lbs.
- 197966CD: Capacitance ranges: 2nF - 20µF
- Temperature: -40° to 1000°C



Tilttable Screen



197958CD



197966CD

Includes: Test leads, protective holder, 9V battery and temperature probe (P/N 197966CD only)

SALE

Part No.	Product No.	1	10	25
197958CD	MV110	\$38.95	\$34.95	\$32.95
197966CD	MV120	\$59.95	\$53.99	\$48.59

11-Function 4000-Count Multimeter with Autorange

- 4000-count large LCD display
- Auto ranging with manual override
- Resolution: 0.1mV max.
- AC/DC voltage ranges: 400mV - 600V
- AC/DC current ranges: 400µA - 10A
- Resistance ranges: 400Ω - 40MΩ
- Capacitance ranges: 4nF - 200µF
- Frequency ranges: 10Hz - 10MHz
- Temperature ranges: 0°F - 1400°F (0°C - 760°C)
- Diode test, duty cycle and continuity
- Relative zero, data hold, range hold, auto off
- Size: 2.4"W x 1.6"D x 4.8"H
- Weight: 0.6 lbs.



Includes: Protective holster with stand, two 1.5V AAA batteries and test leads

Part No.	Product No.	1	10
211650CD	MN26	\$39.95	\$37.95

50,000-Count Digital Multimeter with Analog Bargraph

- True RMS reading
- Auto and manual ranging
- Large LCD display provides easy readability; all test parameters in clear view (0.55" digit height)
- AC/DC voltage protection
- Continuity and diode testing
- Basic DC accuracy: 0.025%
- DC voltage ranges: 500mV - 1000V (10µV - 100mV resolution)
- AC voltage ranges: 500mV - 750V (10µV - 100mV resolution)
- AC/DC current ranges: 500µA - 10A (10µA - 1mA resolution)
- Resistance: 500Ω - 50MΩ (10mΩ - 1kΩ res.)
- Capacitance: 50nF - 50mF (10pF - 10µF res.)
- Frequency: 0.6Hz - 500kHz
- Size: 3.2"W x 1.6"D x 7.5"H
- Weight: 1.5 lbs.



Includes: Probes and manual

Part No.	Product No.	1	10	25	
185201CD	BK5380	Reg. \$279.95	\$149.99	\$127.49	\$95.65

Test Equipment



For test leads to accompany your multimeters see pages 150 - 151.



Opening an account is easy!!
Call
1-800-831-4242
for details today.



Corporate Customers

Pocket Analog Multimeter

- DC/AC voltage ranges: 0 – 500V
- DC current ranges: 0 – 250mA
- Resistance ranges: 0 – 1kΩ
- Size: 2.3"W x 1.2"D x 3.6"H



SALE

Includes: Insulated probes

Requires: 1.5V battery
(recommend P/N 198707CD, pg 202)

Part No.	Description	1	10	50
206287CD	Pocket multimeter	\$8.95	\$8.09	\$7.25

Digital LCR Meter

- 3½-digit display (0.5" digit height)
- Inductance ranges: 200μH to 200H
- Capacitance ranges: 200pF to 2000μF
- Resistance ranges: 2mΩ to 20MΩ
- Dissipation factor measurement
- Size: 3.3"W x 1.4"D x 6.7"H
- Weight: 1.1 lbs.
- One-year warranty



Includes: Test leads and 9V battery

Part No.	Description	1	10	25
127538CD	LCR meter	\$139.95	\$125.95	\$118.95



Passive Component LCR Meter

- Measures L, C, and R with secondary parameter Q, D or R; both are displayed
- Accuracy of 0.7% for L & C, 0.5% for R
- Inductance ranges: 2000.0uH to 2000.0H
- Capacitance ranges: 2000.0pF to 2000.0uF
- Resistance ranges: 20.000Ω to 20.000MΩ
- Test frequencies of 120Hz and 1kHz
- Dissipation Factor (D) reading: 0 to 0.9999
- Quality (Q) reading: 0 to 9999
- Selectable parallel or series equivalent circuit
- Set HI/LO limits, absolute or percentage
- 4½-digit backlit LCD display
- Bidirectional RS-232 port with optional software
- Max./Min./Avg. recording with auto power off
- Size: 3.6"W x 2.1"D x 7.6"H • Weight: 0.8 lbs.



198678CD

Includes: Test leads, alligator clips, 9V battery and holster

Part No.	Description	1	10
198678CD	LCR Meter	\$178.95	\$160.95
189237CD	9VDC @ 300mA adapter	4.25	3.59



See the yellow and green highlighted items, throughout the catalog.

Jameco Special Values!

Details on page 4.

20,000-Count True RMS Benchtop Multimeter



- 6 functions, 22 ranges
- 4½-digit red LED display with 0.5" digit height
- Resolution: 10μV maximum
- DC voltage ranges: 200mV – 1200V (with 0.03% accuracy)
- AC voltage ranges: 200mV – 1000V (with 0.03% accuracy)
- DC/AC current ranges: 200μA – 20A
- Resistance ranges: 200Ω – 20MΩ
- Diode test
- AC or AC+DC coupling
- Interlocking push buttons for easy selection
- 3600 adjustable tilting bail for maximum readability of display
- Input power: 117VAC or 234VAC @ 50-60Hz
- Size: 13.0"W x 9.0"D x 3.1"H • Weight: 4.7 lbs.



Part No.	Product No.	Price
222578CD	BDM40	\$468.95

20,000-Count Benchtop Digital Multimeter

- 4½-digit green LCD
- DC accuracy: 0.05%
- Full overload protection
- Resolution: 10μV max.
- DC voltage ranges: 200mV – 1000V
- AC voltage ranges: 200mV – 750V
- DC/AC current ranges: 2mA – 10A
- Resistance ranges: 200Ω – 20MΩ
- Frequency measurement up to 200kHz
- Continuity check with beeper
- Data hold, diode check, transistor h_{FE} measurement available
- True RMS AC
- One-year manufacturer's warranty
- Size: 9.9"L x 9.8"W x 3.6"H • Weight: 6.1 lbs.



True RMS

Part No.	Product No.	1	10	25
132564CD	DM441	\$219.95	\$209.95	\$199.95

20,000-Count Benchtop Multimeter w/ RS-232, Analog Bar & 4 Displays

- Automatic polarity indicator
- 1-2 readings per second
- DC accuracy: 0.1% +5 digits
- 10 reading storage & compare
- Resolution: 10μV max.
- DC voltage ranges: 200mV – 1000V
- AC voltage ranges: 200mV – 750V
- DC/AC current ranges: 2mA – 20A
- Resistance ranges: 200Ω – 20MΩ
- Frequency ranges: 20kHz – 20MHz
- MIN., MAX., AVE., relative functions
- Logic, diode, transistor h_{FE} and continuity test
- Size: 11.2"L x 8.2"W x 3.2"H • Weight: 7.5 lbs.



METEX

Includes: Manual, power cable, probes and software

Part No.	Product No.	1	10
166852CD	MXD4660A	\$249.95	\$224.95

Fluke 45 100,000-Count Dual-Display Benchtop Multimeter



FLUKE

The Fluke 45 is a feature-rich 5-digit, 100,000 count meter that truly fits all applications and virtually any measurement needed on the workbench or in the field. Two multifunction displays and 16 different measurement capabilities allow wide ranging versatility at an affordable price. The Fluke 45 delivers high performance and flexibility for manufacturing test, depot and field service, as well as R&D applications.

- Multifunction vacuum fluorescent dual display allowing the user to measure two different parameters of the same signal from one test connection, and view both measurements at the same time.
- True-RMS voltage and current, including ac + dc
- Frequency measurement to 1 MHz
- dB measurements: 21 selectable reference impedances from 2 to 8000, and audio power from 2W to 16W
- Compare (Hi/Lo/Pass) function for quick in-tolerance tests
- 0.05% DC current accuracy for 4-20 mA current loop service
- 8 functions, 31 ranges • 2.5 reading per second
- Resolution: 1μV maximum
- DC voltage ranges: 100mV – 1000V
- AC voltage ranges (True RMS; AC-coupled): 100mV – 750V
- DC/AC current ranges: 10mA – 10A
- Resistance ranges: 100Ω – 100MΩ
- Frequency ranges: 1kHz – 1MHz
- Diode and continuity test • RS-232 Interface
- Size: 8.5"W x 11.3"D x 3.7"H
- Weight: 5.2 lbs. (Without battery)

Includes: RS-232C interface

Part No.	Product No.	Description	1	5
222367CD	FLK-45	Multimeter ...	\$748.95	\$711.49
222359CD	FLK-45-01K	Battery pack ..	184.95	175.69

High Voltage AC/DC Test Probe

- Maximum voltages: DC: 40kV, AC: 40kV peak, 28kVRMS
- Accuracy: DC: ±1.5%, AC: ±5%
- 10MΩ meter input impedance required
- Input/output impedance: 1,000MΩ/1.1MΩ
- Cable length: 39"
- Probe length: 14"
- Weight: 0.8 lbs.

SALE



Part No.	Description	1	10
132290CD	High voltage test probe	\$79.95	\$72.95

Find more products on the Jameco website.
Log on today!
www.jameco.com



90-Watt Digital DC Power Supply

30VDC @ 3A

- Constant current and constant voltage operation
- Can be used for positive or negative source
- Overload protection circuit
- Input voltage: 100/240VAC @ 50-60Hz
- Size: 5.2"W x 5.6"H x 10.0"D
- Weight: 10.9 lbs.
- One-year warranty



SALE

Part No.	Product No.	Description	1	10
121152CD	GP4303D	Digital DC	\$199.95	\$189.95

150-Watt Digital Power Supply

30VDC @ 5A

- Adjustable voltage/current outputs
- Constant voltage and current operation
- LCD displays for both current and voltage
- Coarse and fine adjustment knobs for current and voltage
- Color-coded terminals for positive, negative and ground connections
- 2A @ 250V fuse
- Dual digital display
- Input voltage: 110/220VAC @ 50-60Hz (switchable)
- One-year warranty
- Size: 5.4"W x 10.7"D x 6.0"H
- Weight: 13.8 lbs.



SALE

Part No.	Description	1	10	25
153242CD	30VDC @ 5A	\$219.95	\$197.99	\$178.19

150-Watt Power Supply

50VDC @ 3A

- Adjustable voltage/current outputs
- Constant voltage & current operation
- Color-coded terminals for ground, positive and negative terminals
- 3A @ 115V fuse
- Color-coded adjustment knobs for voltage, current and fine adjustment
- Input voltage: 110VAC @ 60Hz
- Color: dark gray
- Size: 9.0"L x 4.75"W x 7.5"H
- Weight: 12.3 lbs.
- One-year warranty



Part No.	Description	1	10	25
163723CD	50VDC @ 3A	\$159.95	\$144.95	\$137.95

100-Watt Triple Output Digital and Analog DC Power Supplies

30VDC @ 3A

- Triple output with fixed 5VDC @ 0.5A, 12VDC @ 0.5A
- Adjustable 0 - 30V voltage and 0 - 3A current outputs
- Displays of both voltage and current
- Constant voltage or current
- Current limiting indicator
- Overload and short circuit protection
- Binding post terminals for variable supply
- Input voltage: 110/220VAC @ 50-60Hz (switchable)
- Size: 9.5"L x 6.0"W x 5.6"H
- Weight: 10.0 lbs.



197991CD



197982CD

Part No.	Description	1	10
197991CD	Digital DC	\$198.95	\$178.95
197982CD	Analog DC	168.95	151.95



150-Watt Linear Power Supply

15VDC @ 10A

- Output voltage: 2VDC to 15VDC
- Output current: 15A max.
- Constant voltage and current operation
- Color-coded terminals for positive and negative terminals, voltage adjustment knob
- Overvoltage, overcurrent, short-circuit protection
- Cigarette lighter output current plug
- LED indicator for power and warning
- Current and voltage panel meter
- Built-in fan
- Input voltage: 110VAC @ 60Hz
- Size: 5.7"L x 6.2"W x 4.0"H
- Weight: 12.0 lbs.



Part No.	Mfr. Cross Ref. No.	1	10	25
175265CD	DPS150A	\$149.95	\$134.95	\$129.95

190-Watt Triple Output Power Supply

Digital Display

- Output voltage: 0 to +30VDC @ 3A, 0 to -30VDC @ 3A, +5VDC @ 2A
- Ripple voltage: less than 3mVp-p
- Volt and current meter: LED display ($\pm 1\%$ + 1 digit)
- Overload protection circuit
- Input voltage: 100VAC/230VAC @ 50-60Hz (switchable)
- Weight: 23 lbs.
- One-year warranty



Includes: Manual and spare fuse

Part No.	Product No.	1	5
157518CD	GP4303TP	\$549.95	\$529.95

225-Watt Analog Power Supply

15VDC @ 15A

- Output voltage: 9VDC to 15VDC
- Output current: 25A max. (22A continuous @ 13.8VDC)
- Constant voltage
- Over-voltage protection @ 16.5V
- Short-circuit protection @ 27.5A
- Color-coded adjustment knob and output terminals for voltage
- Cigarette lighter plug for current output
- Power and fan LED indicator
- Built-in fan
- Voltage and current panel meter
- Input voltage: 110VAC/220VAC @ 47-63Hz (switchable)
- Size: 5.6"L x 6.2"W x 4.0"H
- Weight: 3.8 lbs.



Part No.	Mfr. Cross Ref. No.	1	10	25
175257CD	SPS250A	\$169.95	\$152.95	\$144.95

250-Watt Analog Power Supply

50VDC @ 5A

- Adjustable voltage/current outputs
- Constant voltage and current operation
- Color-coded adjustment knobs for voltage, current, and fine tuning
- Color-coded terminals for ground, positive, negative
- 5A @ 250V fuse
- Isolated ground
- Input voltage: 110VAC @ 50-60Hz
- Color: dark gray
- Size: 4.9"L x 7.7"W x 6.7"H
- Weight: 13.8 lbs.



Part No.	Mfr. Cross Ref. No.	1	10	25
175249CD	DPS5050	\$189.95	\$179.95	\$171.49



100W to 600W Benchtop Power Supplies

- Voltage and current adjustable
- Current restricted and short-circuit protection
- Input voltage: 110/220 $\pm 10\%$ VAC

Analog display power supplies

- Accuracy: 2.5%

Digital display power supplies

- Voltage accuracy: 1% + 2 digits
- Current accuracy: 1.5% + 2 digits



207618CD



207706CD



211705CD

Single Output

Part No.	Product No.	Displays	Power (W)	Voltage (VDC)/Current (A)	Size (W"xH"xD")	Wt. (lbs.)	1	10
207618CD	HY3005C	2-Analog	150	30/5	5.4 x 6.2 x 11.5	14	\$159.95	\$144.95
207626CD	HY3010C	2-Analog	300	30/10	14.4 x 6.5 x 10.4	28	299.95	269.95
207693CD	HY5002	2-Digital	100	50/2	5.4 x 6.2 x 11.5	13	199.95	179.95
207706CD	HY5003	2-Digital	150	50/3	5.4 x 6.2 x 11.5	14	249.95	224.95
207600CD	HY5005	2-Digital	250	50/5	14.4 x 6.5 x 11.5	28	299.95	269.95
207634CD	HY3010	2-Digital	300	30/10	14.4 x 6.5 x 10.4	32	399.95	359.95
207685CD	HY3020	2-Digital	600	30/20	14.4 x 6.5 x 10.4	46	499.95	449.95

Multiple Output

Part No.	Product No.	Displays	Power (W)	Voltage (VDC)/Current (A)	Size (W"xH"xD")	Wt. (lbs.)	1	10
211721CD	HY3002-2	2-Digital	120	0-30/2; 0-30/2	18.1 x 10.3 x 14.1	23	\$249.95	\$224.95
211705CD	HY3002D-2	4-Digital	120	0-30/2; 0-30/2	18.1 x 10.2 x 14.2	23	269.95	242.95
211692CD	HY3003D-2	4-Digital	180	0-30/3; 0-30/3	18.1 x 11.4 x 14.2	28	289.95	259.95
211730CD	HY3003-2	2-Digital	180	0-30/3; 0-30/3	18.1 x 11.4 x 14.1	28	299.95	269.95
211713CD	HY3003-3	2-Digital	195	0-30/3; 0-30/3; 5/3	18.1 x 11.4 x 14.1	29	319.95	287.95
211684CD	HY3003D-3	4-Digital	195	0-30/3; 0-30/3; 5/3	18.1 x 11.4 x 14.1	29	329.95	296.95



Mini DC/AC 2000-Count Clamp Meter/Multimeter

- Bright 1/2" LCD display with DATA HOLD
- 0.5" digit height
- Compatible w/ P/N 162325CD, below
- Size: 7.1"L x 1.9"W x 1.4"H
- Weight: 0.9 lbs.
- One-year warranty



ACA*	20A, 200A	±1.2% +5d
DCA	200A	±1.2% +5d
ACV*	500V	±1.0% +2d
DCV	200V	±0.8% +1d
Resistance	200Ω	±1.2% +1d
*Frequency Response	40-400Hz	
Zero Adjust	External knob for DCA	

Requires: 9V battery not included (P/N 151095CD, pg 202)
Includes: Test leads, manual and case

Part No.	Description	1	10
115756CD	Mini DC/AC clamp meter....	\$119.95	\$107.95

5-Function 4000-Count Clamp Meter/Multimeter

- 4000-count display with bar graph
- Resolution: 0.1mV maximum
- DC/AC voltage range: 600V
- AC current range: 400A
- Resistance range: 400Ω
- Continuity test
- 1.0" max conductor size
- Compatible with P/N 162325CD
- AC line separator, below
- Data hold
- Size: 11.4"L x 6.6"W x 2.1"D



Part No.	Model No.	1	10
192583CD	AC40A	\$74.95	\$72.39

15A AC Line Separator for AC Current Clamp Meters

3-Prong US-Type Plug

- Maximum overload: 250VAC @ 15A
- X1 and X10 clamp areas
- Convenient 0.1"Dia. meter tip test points for neutral/earth/line
- Socket compatible with US & European connectors
- Size: 6.0"L x 1.9"W x 1.4"T



Part No.	Description	1	10	25
162325CD	3-prong separator	\$10.95	\$9.95	\$8.95

50mV/50A Current Shunt

- Current ranges: 0 to 50A
- Accuracy: 0.8% ±0.2mV
- Output ratio: 1mV/1A
- Max. current: 100A
- Size: 5.3"L x 1.2"W x 1.4"H



Part No.	Description	1	10	25
162309CD	Current shunt	\$24.95	\$22.49	\$19.95

17MHz Logic Probe

- Max input freq.: 17MHz
- Minimum pulse width: 30ns
- Input impedance: 1MΩ
- Pulse flash time: 500ms
- Audible tones for high & low
- Power supply protection: ±20V
- TTL threshold: Lo = 0.8V ±0.2V, Hi = 2.3V ±0.2V
- CMOS threshold: Lo = 30% VCC, Hi = 70% VCC
- Size: 7.7"L x 1.0"W x 0.6"H



Part No.	Description	1	10	25
149930CD	Logic probe	\$29.95	\$26.99	\$24.29

Logic Pulser

- Compatible with TTL, DTL and CMOS ICs
- 1MΩ sync input impedance
- "One shot" or continuous 5Hz train pulse
- Pulse repetition rate: 0.5pps/400pps
- Pulse width output at 100mA load: 10μs
- Pulse mode output current: 10mA
- Square wave current output: 5mA
- Size: 7.8"L x 1.0"W x 0.6"H



Part No.	Description	1	10	25
24601CD	Logic pulser	\$19.95	\$17.95	\$15.95

See page 141 for Function Generators and Frequency Counters.



PC Cable-Check™ Tester

Tests standard computer cables for open, shorted and cross-connected wires. PC Cable-Check™ also tests any combination of D-sub 9-pin, D-sub 15-pin, D-sub 25-pin, Centronics 36-pin printer, plus RJ11, and RJ45 telephone plugs. A separate section to check USB-A to USB-B cables, as well as a separate section to check female BNC to female BNC cables.



Includes: Battery and manual

Part No.	Description	1	10
123916CD	PC cable-check™	\$159.95	\$149.95

See page 193 for Modular Network Cables and Jacks.

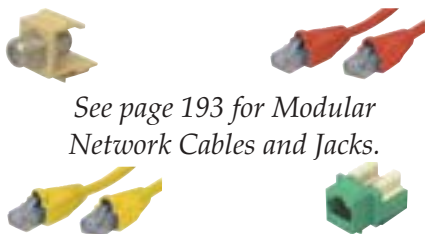

RS-232 Mini-Tester with Status LEDs

Tests any RS-232 (DB25) interface and helps to identify equipment that has failed. Seven bicolor LEDs indicate the status of TD, RD, RTS, CTS, DSR, CD and DTR. LEDs indicate positive (red) and negative (green). No extra power is required. Connectors: male to female DB25.



Part No.	Description	1	10	100
26729CD	Mini-tester	\$10.95	\$9.95	\$8.95

Miniature RS-232 Breakout Box for Quick Design Changes

Design new interfaces or modify old ones quickly and easily. Completely self-contained. Connectors: male to female DB25.



Includes: 25 each 22 AWG wire jumpers and machine tool sockets

Part No.	Description	1	10	100
11181CD	Breakout box	\$8.95	\$7.95	\$6.95

RS-232 Loopback Tester

The tester acts as a data verifier by sending data back to the transmission device. Used for diagnostic testing of RS-232 circuits. 4 LEDs monitor lines 2 to 3, 4 to 5, 6 to 20, and 15 to 17. Connectors: male to female DB25.



Part No.	Description	1	10	100
22728CD	Loopback tester	\$6.95	\$5.95	\$4.45

RS-232 Line Status Tester

Identifies simple interface problems which you can repair yourself. Targets the status of lines 2, 3, 4, 5, 6, 8, 11, 19, and 20. Connectors: male to female DB25.



Part No.	Description	1	10	100
14285CD	Check line tester	\$7.95	\$6.49	\$5.95

RS-232 Signal Adapter/Splitter

- Metal connectors: DB25 female and male, and DB9 male
- Gold-plated contacts



Part No.	Description	1	10	100
105195CD	Tri-port serial adapter	\$7.95	\$6.95	\$5.95

Flexible Multilink RS-232 Tester & Breakout Box

Visually indicates the status of lines 2, 3, 4, 5, 6, 8, 20, and 22 on the DTE and DCE sides. Provides signal status at a glance.

Complete cable "breakout" & reconfiguration. Connectors: DB25 male & DB25 female.

- Cable length: 4"
 - Size: 3.5"L x 3.3"W x 1.0"H
- Includes: handy carrying case, 10 jumper wires and a device wiring chart

Part No.	Description	1	10	25
25945CD	Tester/breakout box	\$22.95	\$19.95	\$17.95



Phone
1-800-831-4242

Fax
1-800-237-6948

Online
www.Jameco.com

We'll Send It Today!

Protected Banana Style Multimeter Test Probes

- Threaded/pointed test tip
- 18 AWG wire
- 42" long
- Black and red
- 2 per package

Part No.	Description	1	10	25
77737CD	Protected probes	\$6.49	\$5.85	\$5.25

Standard Banana Style Multimeter Test Probes

- Black and red
- 18 AWG wire
- 42" long
- 2 per package

Part No.	Description	1	10	25
77745CD	Std. banana probes	\$7.69	\$6.95	\$6.25

PROBE MASTER Probe Test Leads

- 23K gold tips
- Silicon wire
- 1000V rated
- Length: 3'3"
- Spring loaded micro tip

Part No.	Description	1	10	25
174625CD	Includes: 8 plunger type tips			

- 212222CD Includes: Screw-on alligator clips, spade lugs and spring hooks

Part No.	Description	1	10	25
174625CD	Micro tip test leads	\$34.95	\$31.49	\$28.95
212222CD	Softie test leads	29.99	26.49	24.99

PROBE MASTER Probe Kits

- Rating: 1000V 10A
- Gold tips and contacts
- 212231CD: Universal probe kit includes leads with shrouded right angle banana plug, probes, sprung hook probes, alligator clips and spade lugs
- 212249CD: Electronic deluxe probe kit includes same as P/N 212231, plus extender probes, minigrator leads, .025" wire wrap leads, pico hooks and pincer hooks

Part No.	Description	1	10
212231CD	Universal probe kit	\$39.99	\$37.99
212249CD	Electronic deluxe probe kit ...	79.99	75.99

Pomona® Replacement Probe Test Lead Set

- Set of two PVC 48" insulated leads, probe to banana plug
- Fits all DMMs
- Right-angle multimeter connectors

Part No.	Product No.	1	10	25
155951CD	5519A	\$12.95	\$11.49	\$10.49

Breadboard-Pin to Breadboard-Pin Test Leads

- 4 each red, yellow, blue, black, white
- 5.9" long
- 20 AWG wire
- 20 per package

Part No.	Description	1	10	25
77825CD	Breadboard pin leads	\$12.95	\$11.69	\$10.49

Pomona® Basic Electronic DMM Test Lead Kit

Kit Contains 2 Each (Black/Red):

- Test probes with silicone insulated lead
- Slide-on extended tips & alligator clips
- Supplied in a reusable plastic case
- 48" leads
- Fits most equipment with banana jacks

Part No.	Product No.	1	10	25
155942CD	5672A	\$22.95	\$19.95	\$18.95

Universal Test Lead Kit

- Includes: 3 ft. black/red cables, 4.5" black/red insulated test probes, 0.8" needle probes, spade terminals, 2 sets of 4 pieces each red/black insulated alligator clips and banana plug

Part No.	Description	1	10	100
168516CD	Universal kit	\$8.95	\$7.95	\$6.95

Surface Mount Test Clips

Color Coded

- Can access 0.3mm pitch IC leads
- Stackable side by side
- High reliability: gold-plated hook and contact
- High durability: barrel extension is fluorine-resin coated
- Wire length: 3" test clip wires
- Clip/wire color: 2 each black, red, green, yellow, blue and gray

Includes: 3" ground wire with #8 spade terminal

Part No.	Description	1	10
170528CD	SMD nano clips (12)	\$189.95	\$169.95

Micro Test Clip

- One piece per package

Part No.	Description	1	10	100	1000
153162CD	1.6" micro test clip	.75	\$.59	\$.39	\$.29

Mini Test Clips

- Two lengths

Includes: One black and one red hooked probe clip

Part No.	Description	1	10	100
114809CD	1.75" mini test clips	\$1.89	\$1.49	\$1.35
114817CD	3.5" mini test clips	1.75	1.55	1.39

Mini-Clip Test Leads

These spring loaded mini-clips hook easily to IC pins for testing.

- Set of five: red, blue, green, black and yellow
- 14"L; clips on both ends
- 26 AWG to 300V CSA/UL approved wire

Part No.	Description	1	10	100	1000
135298CD	Mini test leads	\$11.49	\$10.39	\$9.29	\$8.39

Pomona® Minigrabber® Test Clip Patch Cord Kits

- One each of 10 colors: black, brown, red, orange, yellow, green, blue, violet, gray and white
- 24" leads; clips on both ends

Part No.	Prod. No.	Description	1	10
156494CD	5523	Patch cord (hook)	\$34.95	\$31.49
156507CD	5521	SMD cord (jaws)	59.95	53.95

BNC to Clip Test Cables



BNC connectors are designed for signal frequencies into the gigahertz range, making them ideal for communications, video & test equipment.

- Micro-clip or mini-clip
- Length: 39"

Part No.	Description	1	10	50	100
11421CD	Micro-clip RG174	\$3.99	\$3.19	\$2.89	\$2.59
11463CD	Mini-clip RG174	4.39	3.99	3.59	3.19

Pomona® BNC to Minigrabber® Test Clips

- RG 174/U, .100" O.D.
- Rating: 300 VRMS max., +50°C (+122°F) max.
- Strain relief: PVC molded directly to connector
- Length: 36"

Part No.	Prod. No.	Description	1	10
176954CD	5187-K-36	Minigrabber® ...	\$21.95	\$19.95

Pomona® BNC Male w/ Molded Strain Relief to Minigrator® Test Clips

- RG 58C/U, .195" O.D.
- Rating: 45 VRMS max., +50°C (+122°F) max.
- Jaws open to .187" max.
- Length: 36"

Part No.	Prod. No.	Description	1	10
176971CD	4532-C-36	BNC/Minigrator® ...	\$17.95	\$15.95

Pomona® BNC Cables

- RG58 C/U 50Ω cable
- BNC male connectors
- Molded strain relief
- Length: P/N 159871CD: 36" P/N 159880CD: 60"

Part No.	Product No.	1	10	25
159871CD	2249-C-36	\$15.95	\$14.39	\$12.95
159880CD	2249-C-60	16.95	14.95	12.95

Insulation-Piercing Test Clips with Banana Jack

Makes contact with insulated wires without cutting stripping. Pierces insulation on wires from 22 to 14 AWG.

- Op. V/A: 30VAC or 60VDC/1A max.

Part No.	Description	1	10	25
217453CD	Piercing clips	\$29.95	\$27.95	\$26.95

Test Leads, Plugs and Binding Posts



Mini-Clip to Banana Test Cables

- Plunger-type action
- Available in black or red
- Positive connection that won't disconnect from components
- Banana plug connection on opposite end
- Length: 3.5' • 20 AWG insulated wire



21864CD

Part No.	Description	1	10	100
21856CD	Black test cable	\$3.95	\$3.55	\$2.99
21864CD	Red test cable	3.95	3.49	2.99

Pomona® Stackable Banana Test Lead Cables



159898CD 159901CD 159919CD

- 5000V @ 15A • 55°C max.
- 159898CD: Two 36" leads, mini clip w/ banana
- 45VAC @ 5A max.; beryllium copper contact and glass filled insulation
- 159901CD: Two 24" leads 159919CD: Two 36" leads

Part No.	Prod. No.	Description	1	10	25
159898CD	3782-36	Mini w/ banana	\$7.95	\$6.95	\$6.25
159901CD	B-24-02	Patch cord	9.95	8.95	7.95
159919CD	B-36-02	Patch cord	9.95	8.95	7.95

Banana-to-Banana Test Leads

- Stackable
- Color coded; 2 each red, yellow, blue, black, white • 9.8" long
- 10 per package
- 18 AWG wire



Part No.	Description	1	10	25
77841CD	Test leads	\$22.95	\$20.69	\$18.59

Double-Banana Plug to Alligator Clips Test Cable

- Red & black rubber boot
- 4" lead wire • Length: 3'



Part No.	Description	1	10	50	100
107422CD	Test cable	\$3.95	\$3.49	\$2.95	\$2.49

Alligator Clip Leads

- 24 AWG wire
- Color-coded, 15" long
- Insulated alligator clip on each end
- 10 per pkg. in assorted colors



Part No.	Description	1	10	100	1000
10444CD	Alligator leads	\$3.99	\$3.59	\$3.25	\$2.95

BNC to Alligator Clip Test Cable

Permits BNC assembly to be used as a test cable.

- Upper connection: two alligator clips – red 5.5" 22AWG wire; black 9" 22AWG wire
- Lower connection: 23" RG/58U cable with BNC connector



Part No.	Description	1	10	100	1000
11383CD	BNC cable	\$3.49	\$2.49	\$2.25	\$2.05

Pomona® Test Lead Holders

- 155985CD:
 - Max cable dia.: 0.450"
 - 11"L • Color: blue
- 155977CD:
 - Max cable dia.: 0.320"
 - 11"L • Color: black
- 155969CD:
 - Max cable dia.: 0.210"
 - 11"L • Color: orange

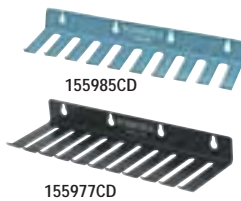

Part No.	Prod. No.	No. of Slots	1	10	25
155985CD	2708B	9	\$9.95	\$9.45	\$8.95
155977CD	4408	10	9.95	9.45	8.95
155969CD	1508	14	9.95	9.45	8.95

Insulated Alligator Clips

- Color-coded
- Insulated barrel
- Jaw opening .375"-0.5"
- Accepts standard banana connector
- Solder strap and pre-drilled hole for 6-32 self threading screw • Size: 2.3"L x 0.5"W



Includes: One red and one black clip

Part No.	Description	1	10	100	1000
70990CD	Alligator clips	\$.39	\$.36	\$.33	\$.30

1 1/16" Banana Plugs

- Set-screw connection
- Standard banana spring plug
- Additional 6-32 threaded hole for connection reliability
- .1875" lead opening
- Insulating sleeve is threaded to banana plug body
- Size: 1.6"L x 0.4"Dia.



Includes: One red and one black plug

Part No.	Description	1	10	100	1000
72194CD	Banana plugs ...	\$1.59	\$1.49	\$1.25	\$1.09

2 1/4" Banana Plugs

- Nine rib spring plug
- Will accept up to 0.1" dia. wire
- Set-screw connection
- Each plug equipped with hole for interconnection
- Size: 2.3"L x 0.3"W
- Insulating sleeve fits snugly over copper post



Includes: One red and one black connector

Part No.	Description	1	10	100
137525CD	Banana plugs	\$2.95	\$2.12	\$1.84

Pomona® Solderless Banana Plug Sets

- 159863CD:
 - Nickel-plated
 - ABS insulation
 - Color: 1 red and 1 black per set
- 159855CD:
 - Set screws secure leads
 - 5000VDC @ 15A • 50°C max.
- 159927CD:
 - Solderless double banana plug w/ wire guide



Part No.	Product No.	1	10	25
159863CD	1825-02 set	\$2.45	\$2.19	\$1.95
159855CD	1325-02 set	2.95	2.69	2.39
159927CD	MDP-02 set	4.49	4.05	3.65

Double Banana Plugs

- Dual gold-plated female banana plugs
- Stackable

125217CD



Part No.	Description	1	10	100
125209CD	Blk banana connector	\$2.39	\$2.15	\$1.89
125217CD	Red banana connector	2.39	2.15	1.95

1" Screw-Type Binding Posts

- For both wire and standard banana
- 0.16" hole for banana test leads
- Chassis mount with lock washer and nut
- Solder tab hole: 0.06" diameter
- Size: 1.0"L x 0.5"Dia.



Requires: 0.32" mounting hole

Includes: One red and one black insulated post

Part No.	Description	1	10	100	1000
71239CD	Binding posts (2)	\$.99	\$.85	\$.69	\$.59

1 3/4" Screw/Solder Binding Posts

- For both wire and standard banana
- 0.16" hole for banana test leads
- Solder post: 0.0625" diameter • Chassis mounting
- Size: 1.8"L x 0.5"Dia.



Includes: One red and one black insulated post

Part No.	Description	1	10	100	1000
77690CD	Binding posts (2)	\$1.09	\$.95	\$.79	\$.69

Double Binding Posts – Dual Banana

- Red/Black design
- Screw-mount
- 0.72" between posts
- Size: 1.6"L x 1.4"W



Part No.	Description	1	10	100
125196CD	Screw mount bind post	\$3.95	\$3.45	\$3.19

Single Binding Post to BNC Male

- Binding post with captive thumb nut
- Accepts standard banana plugs
- Operating voltage: 500 VRMS
- Brass nickel plated

See page 131 for BNC Connectors



Part No.	Description	1	10	100
100600CD	Red binding post	\$1.49	\$1.19	\$.95
100618CD	Black binding post	1.49	1.19	.95

BNC to Double Binding Posts – Dual Banana

- Red/Black design

125233CD



Part No.	Description	1	10	100
125233CD	BNC-female	\$4.49	\$3.99	\$3.55
99354CD	BNC-male	4.95	4.49	4.05

BNC to Standard Double Banana Plugs

- Permits BNC cables to be used with equipment having banana jacks. Lower connection: BNC; upper connection: double banana plug on .750" centers. Cross holes .166" diameter in body provide side stack-up connections.



Part No.	Description	1	10	100
11439CD	BNC banana plug (F)	\$4.49	\$4.05	\$3.65
125225CD	BNC banana plug (M)	4.95	4.39	3.69

ExStik pH Water Proof Meters

This compact, portable pH meter provides a low-cost method for monitoring pH. Ideal for measuring chlorine in drinking water, cooling towers and waste water discharges. Waterproof design floats in water and protects the meter in wet environments. Flat surface electrodes also provide surface pH spot measurements.



EXTECH
INSTRUMENTS

- Measure pH from 0.00 to 14.00 with accuracy of ± 0.01 pH
- Measures temperature from 23°F to 194°F (-5°C to 90°C)
- Smart chip predicts pH electrode performance with "RENEW" indicator when replacement is needed
- "CAL" indicator alerts user to recalibrate
- Large 3½-digit display with bar graph
- Bar graph originates at neutral point (7.0pH) and fluctuates to the left or right depending on the measurement
- Automatic temperature compensation
- Simultaneous display of pH and temperature
- Tripak buffers: 6 each of 4, 7, 10 pH and 2 rinsing solutions
- Size: 6.8"L x 1.6"W x 1.4"T • Weight: 0.3 lbs.

Includes: Meter and electrode, protective sensor cap, sample cup, 4 LR44 button batteries, and neckstrap

Part No.	Description	1	5
218122CD	pH waterproof meter	\$78.95	\$74.95
218131CD	Tripak buffers for calibration ..	24.95	23.69
218165CD	Carrying pouch	18.95	17.95

Heavy Duty pH/mV Temperature Meter

This is an ideal meter for field measurement of pH, millivolts and temperature with laboratory-quality accuracy at a very attractive price.

- Dual display for pH or mV and temperature
- Degrees C/F switchable
- Easy 2-point slope and cal adjustments at pH4 and pH7
- Min./max., and average recall
- Super-large LCD with contrast adjust
- Manual and auto temperature compensation using temp. probe
- Auto shutoff and data hold • Low battery indicator
- Size: 7.0"L x 2.9"W x 1.3"T • Weight: 0.8 lbs.

NEW



EXTECH
INSTRUMENTS

Includes: Temp. probe, pH probe and carrying case

Part No.	Description	1	5
223861CD	Heavy duty temp. meter	\$268.95	\$255.49
218131CD	Tripak buffers for calibration ..	24.95	23.69
218149CD	Vinyl carrying case	9.95	9.49

Digital Light Meter

- Measures in Lux and footcandle ranges
- Range: Lux – 0 - 50,000 Lux (3 ranges); footcandle – 0 - 5,000 Fc (3 ranges)
- Analog output connectors for external recording
- Separate light sensor for optimum location sampling
- 0.5" digit height
- Dimensions (sensor probe): 3.2"L x 2.2"W x 0.5"H
- Weight: 0.9 lbs. • One-year warranty



Part No.	Description	1	10
131764CD	Digital light meter	\$99.95	\$89.95

Pro-Vane Thermo-Anemometer

Remote vane rotates freely to measure airflow and temperature. Ideal for checking performance of fans, blowers, exhaust hoods and HVAC applications.



EXTECH
INSTRUMENTS

- 2.83" remote vane wheel
- Data hold function
- Super large 0.7" LCD display
- Measures air velocity as ft/min, m/s, km/h, knots
- Utilizes Type K sensor for thermometer measurements in the range of 32°F to 140°F (0°C to 60°C) with accuracy of 1.5°F (0.8°C) with 0.1° resolution
- Durable housing case and sensor made of ABS plastic with 39" cable
- Size: 6.6"L x 3.2"W x 1.2"T • Weight: 0.8 lbs.

Includes: Sensor, hard vinyl carrying case, and 9V battery

Part No.	Description	1	5
218093CD	Thermo-anemometer	\$198.95	\$179.95

Mini Thermo-Anemometer



Foldable housing extends 9" for better reach



Waterproof, pocket size with air velocity, temperature and windchill, all in one. Ideal for checking blowers, fans, exhaust hoods and balancing AC/HT ducts.

- Measures temperature and windchill from 0°F to 122°F (-18°C to 50°C)
- Measures wind speed in ft/min. MPH, m/s, km/h, knots and Beaufort force
- Large dual display for air velocity and temperature
- Auto shut-off 20 minutes after last key is pressed
- Water resistant housing floats and drop tested to 6'

Includes: CR2032 lithium battery and lanyard

Part No.	Description	1	5
218085CD	Mini thermo-anemometer	\$88.95	\$84.49

2dB Sound Level Meter

Ideal instrument to measure OSHA compliance, equipment design, community sound ordinances and sound system installations.

- High & low measuring ranges: High: 75 to 130dB; Low: 35 to 90dB w/ 0.1dB res.
- A and C weighing
- Large: 05", 3½-digit display
- Meets ANSI and IEC 651 Type II standards
- Fast/slow response; max. hold with reset button
- Built in calibration check
- Utilizes a 0.49" condenser microphone
- Size: 9.5"L x 2.7"W x 1.0"T • Weight: 0.5 lbs.

Includes: Hard vinyl case and 9V battery



Part No.	Description	1	5
218114CD	Digital decibel sound meter	\$248.95	\$236.49

Waterproof Thermometer



Waterproof housing allows thermometer to be completely submerged in water

- 2.75" stainless steel stem
- Digital display of 0.1° resolution
- C/F switchable ranges -40°F to 392°F (-40°C to 200°C)
- Max./min. recall of high and low temperature
- HOLD and AUTO-OFF features
- Size: 5.9"L x 0.8"W x 0.7"T
- Weight: 0.1 lbs.

Includes: LR44 button battery and protective cover

Part No.	Description	1	5
218077CD	Waterproof thermometer	\$18.95	\$17.95

Electromagnetic Radiation Meter

Electromagnetic radiation is all around us, some of it good, some bad; but there's never been an easier, more portable device to detect and measure it until the ZAP Checker.

Now you can measure your microwave oven's emissions or take engineering measurements of HF, VHF, or UHF transmissions. ZAP Checker does it all. Its portability, multiple settings, ultra-high sensitivity and expanded bandwidth allows you to search out EMR whenever and wherever needed.

- 10MHz to 4.5GHz



Totally Unique

Laser and Contact Tachometer

This combination non-contact and contact laser tachometer is ideal for measuring the revolving speed of fans, motors, gears, pumps, conveyors, and elevators.

- Photo tachometer range: 10 to 99,999 RPM with accuracy of $\pm 0.05\%$ + 1 digit
- Contact tachometer range: 0.5 to 19,999 RPM with accuracy of $\pm 0.05\%$ + 1 digit
- Measures from up to 6.5 feet from the target for improved safety and accessibility
- Memory stores last, maximum and minimum readings
- Display characters reverse direction for measurement type selected
- Large 0.4" (5-digit) LCD display
- Weight: 0.7 lbs.

Includes: 4-AA batteries, tips and wheel for RPM or linear surface speed, reflective tape, & carrying case

Part No.	Description	1	5
218106CD	Laser contact tachometer ..	\$278.95	\$264.95



EXTECH
INSTRUMENTS

Temperature/Humidity Meter with Clock & Min/Max Memory

- Large bright LCD displays for temperature, humidity, and time
- Temperature range: 14°F to 140°F (-10°C to 60°C)
- Humidity range: 10 to 85%
- Clock function displays 12 hour time with AM/PM indication or 24 hour time
- Min./Max. memory function with reset for temperature and humidity
- Size: 4.3"L x 2.8"W x 0.8"Thick



Includes: Built-in tilt stand, AAA battery and wall mounting bracket

Part No.	Description	1	10	25
198053CD	Temp/humidity meter	\$28.95	\$25.95	\$24.49

Indoor/Outdoor Temperature Alarm

- Large 1.5" LCD display
- Displays indoor/outdoor temp. from -58° to 158°F
- Single point alarm (external sensor): set alarm when temperature is above Hi-set or below low set point
- Dual point alarm (external sensor): set alarm when temperature is either outside of or within two set points
- Accurate to 1.8°F with 0.1°F resolution
- Audible alarm and red/green LED indicators
- Size: 2.75"L x 2.75"W



SALE

Includes: 10 ft. weatherproof outdoor sensor, built-in stand, AAA battery and hardware

Part No.	Description	1	10	25
198037CD	Temperature alarm ...	\$17.39	\$16.15	\$15.29

Temperature/Humidity Meter with Min/Max Memory

- Displays (%) relative humidity and temperature (°C/°F) simultaneously
- Min./Max. memory on both relative humidity and temperature with reset function
- Temperature range: 14°F to 140°F (-10°C to 60°C);
- Humidity range: 10% to 99%
- 1" high readout
- Size: 4.3"L x 3.9"W x 0.8"Thick



Includes: Built-in tilt stand, AAA battery, and wall mounting bracket

Part No.	Description	1	10	25
198045CD	Temp./humidity meter	\$38.95	\$34.95	\$32.95

Opening an account is easy!

Corporate Customers

Call 1-800-831-4242
for details today.

Pocket IR Thermometer

Measure the surface temperature of objects which are difficult to reach or unsafe to contact. Also measure hot spots in electrical panels & equipment.

- Temperature range: -58°F to 518°F
- Built-in laser pointer to improve aim
- °F/°C switchable
- Fixed emissivity (0.95) covers 90% of surface applications
- Visual overrange indicator
- 6:1 field of view
- Data hold and max hold
- Pocket size meter



Best Seller!

Includes: 2 AA batteries

Part No.	Description	Price
219361CD	Pocket IR thermometer	\$59.99

Non-Contact Infrared Thermometer

Non-contact thermometer with laser pointer measures up to 600°F (320°C)

- Temperature range: 0°F to 600°F (-20°C to 320°C)
- Basic accuracy: ±2%
- Built-in laser pointer improves aim and accuracy
- Field of view: 6:1 (6" distance measures 1" target)
- 2000-count backlit LCD display
- Audible and visible over range indicators
- Backlit display
- Automatic data hold and power off
- Fixed emissivity covers 90% of surface application
- Size: 8.3"L x 3.5"W x 1.5"D
- Weight: 0.4 lbs.



Includes: 9V battery

Part No.	Description	1	10
211588CD	Non-contact thermometer	\$88.95	\$84.50

Humidity/Temperature Pen Meter and Pen Meter Kit



Compact, digital Hygro-thermometer ideal for field use.

- 2000-count LCD display
- Simultaneous display of temperature and relative humidity
- Capacitance-type sensor
- Max/min and data hold
- Max. resolution: 1% humidity, 1° temperature
- Humidity range: 10% to 90%
- Temperature range: 32°F to 112°F (0°C to 50°C)
- Basic accuracy: ±5%, ±1.5°
- Size: 5.7"L x 1.2"W x 1.0"Thick

Includes: Pocket clip, 3V lithium battery and carrying case

169797CD Includes: same as above plus 33% and 75% RH calibration standards (calibration bottles)

Part No.	Description	1	10
211609CD	Humidity/temp pen meter	\$52.25	\$46.95
169797CD	Humidity/temp pen meter kit	\$89.95	\$81.29

SALE

3999-Count Multimeter with Triple Display, USB Interface and Temperature

- 3½ digit LCD display with triple display (main/sub1/sub2) and analog bar (0.76" digit height)
- Dual display readout for temperature in °C and °F
- Data hold, memory, relative offset, recall, range, minimum/maximum hold functions
- Auto power off
- Auto ranging
- Computer interface: (USB) USB-A male to USB-B male cable with Windows® 98/ME/2000 software (3.5" diskette)



- DC voltage ranges: 400mV – 1000V
- AC voltage ranges: 4V – 750V
- DC current ranges: 400µA – 20A
- AC current ranges: 400µA – 20A
- Resistance ranges: 400Ω – 40MΩ
- Capacitance ranges: 4nF – 200µF
- Frequency ranges: 4kHz – 4MHz
- Temperature: -40°F to 2192°F (-40°C to 1200°C)
- Diode, continuity, transistor hFE, and logic test
- Size: 3.5"W x 1.7"D x 7.8"H
- Weight: 1.6 lbs.

Includes: Manual, probes, K-type thermocouple, USB-A male to USB-B male cable, software, and 9V battery

Part No.	Product No.	1	10
215589CD	M-3890D	\$99.95	\$94.99

LCD Stopwatch with Alarm and Calendar

- Water resistant housing, complete with 39" neck strap and battery
- Large LCD display
- Accurately times a two-person competition
- Displays accumulated elapsed time and split-time measurements
- Timing capacity of 23 hours, 59 minutes, and 59 seconds
- 12/24 hour clock operation with settable hour chime, wake and snooze alarm
- Accurate to ±3 seconds/day
- Size: 2.3"W x 2.8"H x 0.5"Thick



SALE

Part No.	Description	1	10
154739CD	Stopwatch w/ Alarm	\$17.95	\$16.95

Pro-Digital Stopwatch/Up-Down Timer/Alarm/Calendar

- Water resistant housing, lithium battery, and 39" (1m) neckstrap
- Large display provides timing to 1/100th of a second
- Timing capacity: 9 hours, 59 minutes, 59.99 seconds
- Accurate to ±5 seconds/day
- Built-in memory recalls up to 10 laps
- Clock function (12/24hr) features programmable alarm with hourly chime
- Built-in calendar displays day, month, and date
- Countdown timer function features input ranges from one minute to 9 hours, 59 minutes



SALE

Part No.	Description	1	10	25
198029CD	Stopwatch/timer	\$27.49	\$24.95	\$23.39



16 to 30-Watt Variable Soldering Iron, Stand & Sponge

- 116572CD: Length: 7.5"
- 36329CD: Black anodized steel base - 5.3"L x 3.3"W
- See below for replacement sponge (P/N 134631CD)
- Fits most soldering irons .85" diameter

Includes: Sponge

Part No.	Description	1	10	100
116572CD	Soldering iron	\$18.95	\$17.09	\$15.35
36329CD	Soldering stand	4.25	3.85	3.45
134631CD	Sponge (for P/N 36329CD)	2.99	2.69	2.49

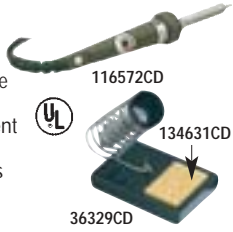

Special Low-Cost Irons

30-Watt Soldering Iron and Stand

- UL approved
- Ideal for precision work
- 1/4" removable tip
- Length: 8.3"
- 110-120VAC

Part No.	Description	1	10	100
102461CD	30W soldering iron	\$4.79	\$4.35	\$3.89
116020CD	Replacement tips (2)	2.25	1.79	1.25
36329CD	Soldering stand	4.25	3.85	3.45



35-Watt Soldering Iron

- UL approved
- Ideal for maintenance and hobby use
- 0.157" removable tip
- Length: 8.1" • 110-120VAC

Part No.	Description	1	10	100
208987CD	35W soldering iron	\$2.99	\$2.69	\$2.45
208995CD	Replacement tips (2)	.99	.89	.79
209074CD	Solder Roll, 8mm (.031")	5.49	4.89	4.39



Light-Duty 23-Watt Soldering Iron & Kit

- Ideal for hobby or electronics kit work
- 1/8" removable tip
- Indicator light
- Length: 8"
- 120VAC @ 60Hz

- 191960CD: Includes iron, MT1 (cone shaped), MT2 (screwdriver), MT3 (chisel) 1/8" tips, lead free solder, soldering aid tool and stand • Weight: 2.0 lbs.
- 189384CD/191978CD/191986CD: 2 pack

Part No.	Description	1	10	25
152872CD	Iron only (SP23L)	\$14.95	\$13.49	\$11.95
191960CD	Iron kit (SP23LK)	17.19	16.35	14.89
189384CD	1/8" cone tip (MT1)	4.95	4.49	3.95
191978CD	1/8" screwdriver tip (MT2) ..	3.79	3.59	3.45
191986CD	1/8" chisel tip (MT3)	4.95	4.49	3.95

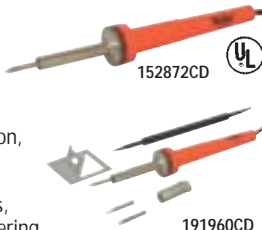

Weller® 40-Watt Soldering Iron

- Develops 900°F (482°C) of heat
- MT10 1/4" (10mm) diameter replaceable nickel plated copper tip
- Stainless steel barrel • Length: 8.25"
- 120VAC @ 50-60Hz • Weight: 0.27 lbs.
- Heat & impact resistant handle

Part No.	Prod. No.	Description	1	10
170561CD	SP40L	40W solder iron ...	\$15.95	\$14.39
188980CD	MT10	1/4" chisel tip 2 pk ...	6.99	6.29



Economical, High-Performance Soldering Irons

High-quality soldering irons that are suitable for both professional and do-it-yourself applications.

- 25W, 40W, & 60W
- Length: 9"
- 120VAC: 6' cord with 3-prong plug
- 226000CD (chisel, std.);
- 226018CD (conical, opt.) - tips for 224611CD/224602CD
- 226026CD (chisel, std.);
- 226034CD (conical opt.) - tips for 195223CD

Part No.	Product No.	1	10	25
224611CD	200PHG-25W	\$7.95	\$7.15	\$6.45
224602CD	200PHG-40W	9.95	8.95	8.09
195223CD	200PHG-60W	13.95	12.49	12.11
226000CD	44-240517	.95	.85	.79
226018CD	44-240513	.95	.85	.79
226026CD	44-240617	1.95	1.79	1.59
226034CD	44-240603	1.95	1.79	1.59

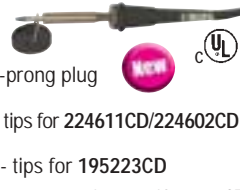

Thermally Balanced 25-Watt Soldering Iron

The XY200GX is a thermally balanced soldering iron for the professional or hobbyist.

- 120VAC; 6' cord • 25-watt power consumption
- Interchangeable tips (pg 156)
- One-year warranty • UL listed • Length: 8.0"

Includes: 1.6mm conical tip

Part No.	Description	1	10	25
129040CD	25W solder. iron	\$11.49	\$10.35	\$9.35



High-Quality 25-Watt & 35-Watt Soldering Irons

- Interchangeable heater elements
- Lightweight handle with cushioned grip
- Quick change knurled collar
- Length: 9"
- 120VAC @ 60Hz

Includes: Power cord & ST3 tip (pg 157)

Part No.	Product No.	Description	1	10
170587CD	WP25	25W solder iron	\$32.95	\$31.35
192102CD	WP35	35W solder iron	39.95	35.95
192153CD	PH25	Solder iron stand	16.19	15.35



Weller® 100-Watt Soldering Iron

- "Closed loop" method of controlling maximum tip temperature
- Nominal heat-up time with 700°F tip is 110 seconds
- 120VAC @ 60Hz input • Length: 6" • Wt.: 0.7 lbs.

Includes: CT6F7 (0.375" screwdriver tip; 700°F)

Part No.	Prod. No.	Description	1	10
192081CD	W100PG	Solder iron	\$59.95	\$56.95
192090CD	CT6F7	.375" screwdriver tip	9.95	8.49

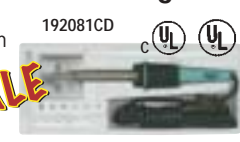

SMD Tweezer Iron

- Maximum efficiency ceramic heating elements insures rapid heat-up and instant heat recovery
- Max. temp.: 760°F
- 120VAC
- Heater insulation exceeds 100MΩ
- Heater power consumption: 35W each

Includes: 0.095" tip

Part No.	Description	1	10	25
168410CD	Tweezer iron	\$59.95	\$53.95	\$48.95
168583CD	Tip .078"	11.95	10.79	9.69
168591CD	Tip .590"	12.95	11.69	10.49



WAHL® Cordless Soldering Iron

The #1 choice for field service soldering!

IsoTip® Power Pro Model #7904

- 900°F tip temperature
- Iron performance equivalent to 25-watt iron
- Solders 200+ joints or up to 30 minutes of continuous soldering
- LED indicator light
- Weight: 1.1 lbs.

Includes: Soldering iron, recharging stand, Ni-Cad battery pack, and tips

Part No.	Description	1	10
132783CD	Power Pro cordless iron	\$58.95	\$57.55



Weller® Cordless Soldering Iron Kit

- Self igniting and instant heat
- Adjustable temperature (25W to 125W)
- Auto switch off
- Visible gas level
- Additional tips can be special ordered
- 2 hours of heat on average tank setting

Includes: soldering tool, hot blow tip, hot knife tip, 2.4mm and 4.8mm double flat tip, cleaning sponge, storage case and instruction manual

Part No.	Prod. No	Description	1	10
152207CD	PSI-100K	Tool kit	\$74.95	\$71.29



Electric & Manual Desolder Pumps

- Easily disassembled for cleaning
- One-hand operation
- Replacement tips available

19254CD: • UL listed • Size: 10.5"L x 1.0"Dia.

Part No.	Description	1	10
19254CD	Electric desolder pump	\$26.95	\$23.95
19166CD	Manual desolder pump	4.95	4.49
19262CD	1 tip for 19254CD	4.95	4.49
22091CD	2 tips for 19166CD	4.49	3.95



Vacuum Pen Tools

- Picks up components with weight of 1.1 lbs. or less
- ESD safe body

207239CD: 4 tips and cups
207247CD: Aluminum body; 6 tips and cups

Part No.	Description	1	10	25
207239CD	Handivac tool	\$18.69	\$16.79	\$15.15
207247CD	Pen Vac tool	37.95	34.25	30.49

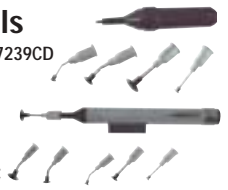

45-Watt Analog Display Soldering Station

Grounded Soldering Tip

- 500°F to 850°F • Fully grounded
- Insulated ceramic heating element for rapid heat-up and heat recovery • Wt.: 2.5 lbs.
- Heater insulation exceeds 100MΩ
- Zero voltage circuitry eliminating high voltage spike and magnetic field generation • Size: 7.0"L x 4.5"W x 3.5"H

Includes: Manual and 1.2mm diameter conical tip

Part No.	Product No.	Description	1	10	25
156785CD	379	Soldering station	\$59.95	\$53.95	\$48.95
156814CD	XYB01	Sharp conical chisel 1/32" tip	4.95	4.49	3.95
156822CD	XYB04	Conical chisel 1/16" tip	4.95	4.49	3.95
134631CD	SP715	Replacement sponge for P/N 156785CD	2.99	2.69	2.49

60-Watt Digital Display Soldering Station

Designed for soldering situations where precise temperature is required for sensitive components.

- Temperature is maintained at ±6°F
- Electronic temperature control from 392° to 878°F
- External calibration port
- CMOS devices protected against voltage spikes
- Power-on and heater-on LED indicators
- Size: 5.1"W x 8.0"D x 4.0"H
- Weight: 4.8 lbs.

Includes: One 1/16" tip (P/N 35115CD – below)

Part No.	Product No.	Description	1	10	25
162456CD	XY9-60D	Soldering station with ESD	\$129.95 \$109.95	\$99.95	\$89.95
168401CD	TWZ50ESD	SMD tweezer iron w/ 0.078" tip	79.95	71.95	64.95
168583CD	46-060102	Tip .078" for P/N 168401CD	11.95	10.79	9.69
168591CD	46-060115	Tip .590" for P/N 168401CD	12.95	11.69	10.49
134631CD	SP715	Replacement sponge for P/N 162456CD	2.99	2.69	2.49

ESD Safe!

UL

Special 5% Bundle Bonus

Complete digital solution for an ISO 9000 Soldering/Desoldering Station –
P/N 162456CD & 125508CD
Sold separately \$439.90
Combined: P/N 207263CD
\$407.95

SALE

60-Watt Analog Display Soldering Stations

Maintains a steady temperature using a cartridge heating element, providing a longer life for the solid soldering tip.

- Electronic temperature control: 300°F to 850°F
- CMOS devices protected against voltage spikes
- Size: 4.3"W x 6.0"D x 3.4"H • Weight: 4.1 lbs.

Includes: One 1/16" tip (P/N 35115CD – below)

Part No.	Product No.	Description	1	10	25
114569CD	168-3C	Analog display station	\$89.95	\$79.95	\$72.95
219627CD	XY9-60A(CH)	Analog display station	99.95	89.95	79.95
134640CD	SP815	Replacement sponge for P/N 114569	2.99	2.69	2.49

Desoldering & Soldering/Desoldering Stations

- Simple fine tune feature to select within 300–850°F range
- Vacuum pump activated "on demand" using finger tip switch on desolder handle
- CMOS devices protected against voltage spikes
- Replacement sponge for P/N 125516CD – below

125508CD: Size: 9.2"L x 7.2"W x 3.6"H; Weight: 13.1 lbs.

Includes: 3/64" conical tip and solder holder

125516CD/223853CD: Size: 11"L x 10"W x 4.0"H; Weight: 18.1 lbs.

Includes: 1/32" conical tip, solder holder, tip cleaner and tweezers

223853CD: Dual display of tip temperature with selector switch for C or F and read/set temperature

Part No.	Product No.	Description	1	10	25
125508CD	968	Desoldering station	\$299.95	\$269.99	\$242.99
125516CD	988	Soldering/desoldering station	399.95	359.99	323.99
223853CD	988D	Soldering/desoldering (dual display)	459.95	413.95	372.55
202721CD	TWZ60ESD	SMD tweezer iron w/ .078" tip	69.95	62.95	56.95
207221CD	D1A60A	Replacement desoldering iron	74.95	67.49	59.95
168583CD	46-060102	Tip .078" for P/N 207271CD	11.95	10.79	9.69
168591CD	46-060115	Tip .590" for P/N 207271CD	12.95	11.69	10.49

Tips & Replacement Parts For XYTronic Soldering and Desoldering Products

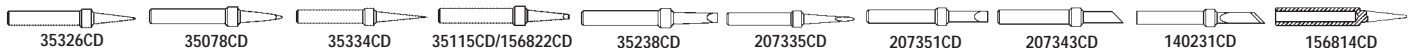

Part Number	Product Number	Description	For XYTronic Model Numbers (*Legacy Models)										Pricing						
			168-3C	168*	200X, 200PG	RESD, 10ESD	XY960A	960D*	968	988	999SDA*	JS236*	168-3C	2660*	1	10	25		
35326CD	XY401	Soldering tip - conical bevel 1/32"	✓	✓	✓	✓	✓	✓	✓	✓	✓	✓	✓	✓	✓	✓	\$4.49	\$3.95	\$3.65
35078CD	XY402	Soldering tip - semi-chisel 1/32"	✓	✓	✓	✓	✓	✓	✓	✓	✓	✓	✓	✓	✓	✓	4.49	3.95	3.65
35334CD	XY403	Soldering tip - conical sharp 1/64"	✓	✓	✓	✓	✓	✓	✓	✓	✓	✓	✓	✓	✓	✓	4.49	3.95	3.65
35115CD	XY404	Soldering tip - conical chisel 1/16"	✓	✓	✓	✓	✓	✓	✓	✓	✓	✓	✓	✓	✓	✓	4.49	3.95	3.65
35238CD	XY405	Soldering tip - semi-chisel wide 1/8"	✓	✓	✓	✓	✓	✓	✓	✓	✓	✓	✓	✓	✓	✓	4.49	3.95	3.65
207335CD	XY406	Soldering tip - long conical chisel 3/64"	✓	✓	✓	✓	✓	✓	✓	✓	✓	✓	✓	✓	✓	✓	2.95	2.69	2.39
207351CD	XY410	Soldering tip - chisel 3/16"	✓	✓	✓	✓	✓	✓	✓	✓	✓	✓	✓	✓	✓	✓	2.95	2.69	2.39
207343CD	XY411	Soldering tip - wedge 3/16"	✓	✓	✓	✓	✓	✓	✓	✓	✓	✓	✓	✓	✓	✓	2.95	2.69	2.39
140231CD	XY430	Soldering tip - SMD flat pack 7/32"	✓	✓	✓	✓	✓	✓	✓	✓	✓	✓	✓	✓	✓	✓	8.95	7.95	7.25
156814CD	XYB01	Soldering tip - sharp conical chisel 1/32"	✓	✓	✓	✓	✓	✓	✓	✓	✓	✓	✓	✓	✓	✓	4.95	4.49	3.95
207301CD	XYB02	Soldering tip - conical semi-sharp 1/32"	✓	✓	✓	✓	✓	✓	✓	✓	✓	✓	✓	✓	✓	✓	4.95	4.49	3.95
207327CD	XYB03	Soldering tip - conical sharp 1/64"	✓	✓	✓	✓	✓	✓	✓	✓	✓	✓	✓	✓	✓	✓	4.95	4.49	3.95
156822CD	XYB04	Soldering tip - conical chisel 1/16"	✓	✓	✓	✓	✓	✓	✓	✓	✓	✓	✓	✓	✓	✓	4.95	4.49	3.95
207298CD	XYB05	Soldering tip - semi-wide chisel 1/8"	✓	✓	✓	✓	✓	✓	✓	✓	✓	✓	✓	✓	✓	✓	4.95	4.49	3.95
207280CD	XYB06	Soldering tip - long conical chisel 3/64"	✓	✓	✓	✓	✓	✓	✓	✓	✓	✓	✓	✓	✓	✓	4.95	4.49	3.95
207319CD	XYB30	Soldering tip - wedge blade 3/16"	✓	✓	✓	✓	✓	✓	✓	✓	✓	✓	✓	✓	✓	✓	8.95	8.09	7.25
35191CD	XY25	Soldering tip - conical sharp 1/64"	✓	✓	✓	✓	✓	✓	✓	✓	✓	✓	✓	✓	✓	✓	6.49	5.85	5.25
35297CD	XY37	Heating element - (nichrome)	✓	✓	✓	✓	✓	✓	✓	✓	✓	✓	✓	✓	✓	✓	20.95	18.95	16.95
35318CD	XY48	Assembly - 60W w/ nichrome heater	✓	✓	✓	✓	✓	✓	✓	✓	✓	✓	✓	✓	✓	✓	30.95	27.95	24.95
127634CD	XYD10	Desoldering tip - 1.0mm (.0394")	✓	✓	✓	✓	✓	✓	✓	✓	✓	✓	✓	✓	✓	✓	8.95	7.95	7.25
127642CD	XYD12	Desoldering tip - 1.2mm (.0472")	✓	✓	✓	✓	✓	✓	✓	✓	✓	✓	✓	✓	✓	✓	8.95	7.95	7.25
127651CD	XYD15	Desoldering tip - 1.5mm (.0586")	✓	✓	✓	✓	✓	✓	✓	✓	✓	✓	✓	✓	✓	✓	8.95	7.95	7.25

Fume Extractors and Filters

Absorbs noxious lead fumes using activated-carbon filter and a high-efficiency fan

- Operate continuously providing filtered air
- Air flow: 115 CFM
- Compact size allows use on work bench with minimum space
- 120VAC, 60Hz, 22 watt
- On/off power switch
- Aerodynamic hood design for effective removal of solder fumes
- Noise: 49dB fan
- Fuse protected
- Static ground jack
- Removable carbon-impregnated filter
- One-year warranty



168268CD



120150CD

168268CD:

- High carbon plastic case
- Size: 8.5"W x 5.0"D x 8.0"H
- Weight: 4.2 lbs.

120150CD:

- Black anodized aluminum case
- Size: 6.4"W x 4.6"D x 7.9"H
- Weight: 4.6 lbs.

Includes: Detachable power cord

SALE

Part No.	Description	1	10	25
168268CD	Fume ext. (ESD safe)	\$59.95	\$53.95	\$49.95
120150CD	Fume extractor	58.95	52.95	47.79
127183CD	Replace. filters (2/pk)	10.95	9.95	8.95

Combination 42-Watt Soldering Station and Fume Extractor

- Power consumption: 42W @ 650°F (soldering iron)
- Adjustable knob for temperature control: 500° to 800°F
- Stability @ idle: ±9°F
- Maximum air volume: 95/115CFM
- Electronic zero-voltage switching
- LED indicator for pilot light & lighted on-off switch
- Input voltage: 100-120VAC @ 60Hz
- Size: 6.4"W x 7.8"H x 4.7"D
- Weight: 5.2 lbs.



Includes: Soldering iron, iron holder, sponge, carbon activated filter, power cord and manual

Part No.	Product No.	1	10	25
183169CD	456DLX	\$99.95	\$89.95	\$80.99

Don't worry about backorders.
Over 99% of our products
are in stock!

We'll Send It Today!

Just place your order by 6PM EST
for same business day shipment

Weller® 40-Watt Soldering Station

- Lighted on/off switch
- Adjustable power from 5 watts to 40 watts
- 120V @ 60Hz
- Temperature is electronically controlled from 350° to 850°F
- Size: 5.5"L x 4.5"W x 3.5"H • Weight: 1.9 lbs.



Includes: ST3 1/8" screwdriver tip, soldering station and manual

Part No.	Prod. No.	Description	1	10
146595CD	WLC100	Soldering station	\$49.95	\$44.95

Weller® Soldering Tips

Replacement Tips for WLC100, WP25 & WP23

Part No.	Prod. No.	Description	1	10
146608CD	ST1	Screwdriver tip 1/16"	\$5.95	\$5.35
146616CD	ST3	Screwdriver tip 1/8"	5.95	5.35
192145CD	ST6	Screwdriver tip .031"	5.25	4.75
146624CD	ST7	Conical tip 1/32"	5.95	4.95

40-Watt Digital Display Soldering Station

- Microprocessor controller for accuracy and dependability
- Digital LED display allows you to read temp. setting and actual tip temp. – accuracy for most demanding applications
- Temp. accuracy: calibrated to ±9°F
- Temp. stability: ±10°F
- ESD safe to protect sensitive components
- Quick disconnect plug for soldering iron and lighted on/off switch • Weight: 4.5 lbs.
- 120VAC @ 60Hz input • Size: 5.9"L x 4.5"W x 3.6"H



Weller®

Includes: EC1201A 40W soldering iron

Part No.	Prod. No.	Description	Price
191994CD	EC2002M1	Solder Station	\$299.99

42-Watt Controlled-Output Soldering Station

- Transformer powered soldering station complete with macro style, low voltage, temp. controlled soldering iron
- Closed loop method of controlling max. tip temp. for protection of temp. sensitive components
- Power unit housing features impact resistant plastic for durability • Size: 5.9"L x 4.5"W x 3.6"H
- Quick disconnect plug for soldering iron and lighted on/off switch • Uses PT series tips
- Separate conductor grounds iron tip and terminates third pin of power cord • Weight: 4.0 lbs.
- 120VAC @ 60Hz input



Includes: Soldering iron and PTA7 tip (below)

Part No.	Prod. No.	Description	1	10
170552CD	WTCPT	Solder station ...	\$129.95	\$124.95
192161CD	TC201T	Replac. iron	68.95	62.05
192170CD	PTA6	.062" screwdriver tip (600°F)	6.95	6.25
192188CD	PTA7	.062" screwdriver tip (700°F)	5.69	5.15
192196CD	PTA8	.062" screwdriver tip (800°F)	5.69	5.15

50-Watt Analog Display Soldering Station

Innovative heater and sensor combination for quick heat-up and rapid temperature recovery

- Tip temperature offset capability allows user to reset temperature readings to match tip size and style
- Wireless temperature lockout
- Auto power-down after 90 minutes of inactivity
- Temperature range: 350°F to 850°F
- Temp. accuracy: ±9.0F • ESD safe
- Size: 5.9"L x 4.5"W x 3.6"H • Weight: 4.0 lbs.



Weller®

Includes: PES51 50W soldering iron with ETA tip, PH50 stand and sponge, and adjustment tool

Part No.	Product No.	1	10
217461CD	WES51	\$115.95	\$105.95

Weller® Soldering Tips

Replacement Tips for WES50

- Tip leakage: less than 2mV
- Tip to ground resistance: less than 2Ω
- Tips also used with WCC100 station
- Additional tips can be special ordered

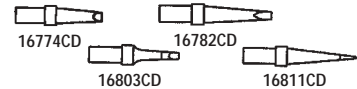

Part No.	Prod. No.	Description	1	10
16774CD	ETA	Screwdriver 1/16" ...	\$6.95	\$6.25
16782CD	ETJ	Long screwdriver 1/32"	6.95	6.25
16803CD	ETR	Narrow screwdriver 1/16"	6.95	6.25
16811CD	ETS	Long conical 1/64"	6.95	6.25

SMD Rework Station

Engineered to meet the demanding needs of today's electronic industry, technician service/repair centers, and assembly work. With this system, replacement of surface mount devices or dual-in-line components is a snap. It not only increases productivity in SMD assembly repair, but achieves a new standard of quality, superior performance, and ease of operation.



- High-performance, inexpensive, versatile
- Adjustable temperature: 250°C - 450°C (482°F - 842°F)
- Thermocouple sensor for stable temperature
- Long-life ceramic heating element
- Rapid heat-up and recovery
- 40W station, 25W ceramic element
- Size: 7.4"L x 5.0"W x 3.3"H
- Weight: 2.6lbs.

Includes: Base power unit, sponge, stand, surface mount tweezer iron, and stand for tweezers

Part No.	Description	1	10	25
224629CD	Rework station	\$89.95	\$80.99	\$72.85

Rosin Core Solder Rolls and Pocket Packs

Part No.	Mfr.	% Composition			Dia. (In.)	Wt. (lbs.)	Pricing					
		Tin	Lead	Silver			1	10	50	100		
141778CD	32117CD	73576CD	Kester (pak)	60	40	0	.031	0.04	\$2.59	\$2.35	\$1.99	\$1.85
		32117CD	Kester	60	40	0	.031	1.00	13.19	11.89	10.69	9.59
		73605CD	Kester (pak)	62	36	2	.020	0.10	1.75	1.49	1.31	1.15
		112344CD	Kester	63	37	0	.020	1.10	17.95	16.19	14.55	13.09
		151474CD	Kester*	63	37	0	.031	1.00	14.95	13.49	12.15	10.95
		170456CD	Golden	60	40	0	.031	0.06	1.39	1.25	1.05	.74
		141794CD	Super	60	40	0	.031	0.55	5.95	5.39	4.85	4.35
		141786CD	Super	60	40	0	.031	1.10	7.95	6.95	6.25	5.59
		141778CD	Super	60	40	0	.031	2.20	13.95	12.95	11.95	10.95

* Organic core

Lead-Free Solder Tip Tinner

Prevents oxide buildup and tin depletion on the tip. Increases tip life and heat transfer resulting in a better solder joint!

- 0.7 oz. tin with self adhesive pad



Safe and Effective!

Part No.	Description	1	10	50
132986CD	Lead-free tip tinner	\$4.95	\$4.59	\$4.19

5' No-Clean Desolder Braids

Meets all of the most stringent soldering standards for worldwide application including: MIL-F-142560D Type R, NASA specification NHB5300.4, NPC200-4 and SP-5002.

- Length: 5'



139951CD 124126CD



Part No.	Description	1	10	100
139951CD	.030"W desolder braid	\$2.25	\$1.95	\$1.75
124126CD	.060"W desolder braid	2.25	1.95	1.75
124118CD	.075"W desolder braid	2.25	1.95	1.75

5' Desoldering Braids

- Easy-to-use, handy dispenser
- Braided copper with flux



41099CD

Part No.	Description	1	10	100
41081CD	.079"W braid (5')	\$1.49	\$1.20	\$.95
41099CD	.098"W braid (5')	1.55	1.29	1.15
153461CD	.120"W braid (5')	1.59	1.39	1.25

One-Shot Desoldering Gun

This low maintenance desoldering gun with self-contained vacuum pump is perfect for desoldering through-hole components.

- Power consumption: 60W
- Interchangeable standard tips
- Zero static tip, 3 wire grounded
- Sensitive where CMOS protection is needed
- Quick release stainless solder collector
- Electronic temperature control
- Ergonomic, lightweight design
- 120VAC • One-year warranty
- Gun casing size: 7.0"L x 4.0"W • Weight: 2.2 lbs.

Includes: 1.0mm tip

Part No.	Description	1	10	25
129066CD	Desolder gun	\$99.95	\$89.95	\$79.95
140214CD	*Y* replacement tip	10.95	9.95	8.95
134594CD	1.0mm replace. tip	8.95	7.95	7.19
134607CD	1.2mm replace. tip	8.95	7.95	7.19



Soldering Tip Cleaner with Stand and Rosin Paste Flux

156777CD:

- For cleaning soldering iron tips without the use of water and sponge
- Metal wool for cleaning
- Rubberized base for stability



156777CD 73584CD

73584CD: Highly active non-corrosive and non-conductive flux with excellent wetting action

Part No.	Description	1	10	50
156777CD	Tip cleaner & stand	\$4.95	\$4.49	\$4.05
160004CD	Metal wool replacement	2.79	2.49	2.29
73584CD	Rosin paste flux (2 oz.)	1.79	1.65	1.45

Desoldering Wick

No more burnt fingers

- Handy dispenser • Length: 5'
- Pure copper braid
- No clean flux formula



SALE

Part No.	Description	1	10	25
175986CD	0.067"W braid	\$2.49	\$1.99	\$1.79

Clip-On Heat Sink

- Absorbs and dissipates heat during soldering and desoldering sensitive parts
- Size: 2.7"L x 0.7"W



Part No.	Mfr. Cross Ref. No.	1	10	25
159126CD	HT156	\$2.49	\$2.25	\$1.99

Heat Sink and 7-Piece Soldering Aid Kit



100378CD

100503CD

100378CD: Heat sink absorbs and dissipates heat during soldering & desoldering of sensitive parts
100503CD contains: Soldering wick, 3 pc. scraper set, acid brush, clip-on heat sink and empty squirt bottle

Part No.	Description	1	10	50
100378CD	Heat sink	\$.85	\$.74	\$.59
100503CD	Soldering kit	4.95	4.49	3.95

Plastic Pump Bottle

- 6 oz. bottle
- ESD compliant
- Plastic bottle with dispenser cover



Part No.	Description	1	10	50
158131CD	Pump bottle	\$9.95	\$8.95	\$7.95

300-Watt Solder Pot

Temperature Regulated between 420 – 450°C

- HI/LO switch selectable for temperature
- 2 conductor power cord: 5' 9" long
- Holds up to 1 bar of P/N 170464CD or 176057CD, below
- Input voltage: 110VAC @ 2.7A; 50-60Hz
- Size: (unit) 4.8"H x 5.5" Dia. (base)
- Size: (tub) 2.4"Dia. x 1.6"D
- Weight: 5.9 lbs. • One-year warranty



Part No.	Description	1	10	25
160303CD	300W solder pot	\$64.95	\$58.49	\$52.65

600-Watt Solder Pot

Temperature Adjustable

- 2-wire power cord (5'5")
- Temperature: 0°C to 500°C
- Self regulating temperature
- On-off power switch and LED indicator for heat
- Input voltage: 110VAC @ 5.5A
- Holds up to 3 bars of P/N 170464CD or 176057CD, below
- Size (unit): 6.8"L x 5.5"W x 2.8"H
- Size (tub): 3.9"L x 1.6"D • Weight: 7.4 lbs.



Includes: Skimmer and removable dross tray

Part No.	Description	1	10
172275CD	600W solder pot	\$189.95	\$159.95

2000-Watt Solder Pot

- Thermostat control for setting temperature from 50°C to 300°C
- Holds up to 48 bars of P/N 170464CD or 176057CD, below
- Input voltage: 110VAC @ 18A 50-60Hz single phase
- 3 conductor pigtail power cord: 5' long
- Size (unit): 18.1"L X 11.5"W X 6.0"H
- Size (tub): 12.0"L X 8.0"W X 2.9"H
- Weight: 23.1 lbs. • One-year warranty



Part No.	Description	1	5
149876CD	2000 watt solder pot	\$399.95	\$359.95

Solder Bars

- Used for soldering pots
- Tin/lead: 60/40 & 63/37
- Size: 13"L x 0.9"Dia.



170464CD

Part No.	Description	Wt. (lbs.)	1	10	25
176057CD	60/40	1.1	\$8.49	\$7.65	\$6.89
170464CD	63/37	1.8	6.95	6.60	6.25

Solder Spool Stand

- 12 pc. solder spool stand (some assembly required)
- Size: 3.6"W x 3.9"D x 4.3"H
- Shaft dia.: 0.6" • Weight: 1.6 lbs.

Solder not included



Part No.	Description	1	10	100
141760CD	Solder spool stand	\$8.95	\$7.95	\$6.95

Solder Spool and Iron Stand

- 4 pc. spool stand (some assembly required)
- Shaft diameter: 0.6"
- Size: 6"L x 3.5"W x 3.1"H
- Sponge size: 1.6"W x 2.4"L
- Weight: 2.0 lbs.

Solder not included



Part No.	Description	1	10	100
169551CD	Spool & iron stand	\$16.95	\$15.29	\$13.75

See page 224 for New Weller Soldering Station

Clamp Vise

- Lightweight, sturdy construction
- No tools needed – finger turn to tighten
- Ball cup allows vise to adjust to any angle
- Nylon jaws open 2" • Size: 10.0"L x 2.5"W



Part No.	Description	Wt. (lbs.)	1	10
127167CD	Clamp vise	2.1	\$19.95	\$17.95

PANA VISE Vacuum Vise

- Features the patented "split ball" that tilts, turns and rotates through three planes
- Nylon jaws open a full 2.25"
- Powerful suction pad for quick and easy set-up
- Size: 5.0"L x 4.0"W x 6.3"H
- Weight: 3.3 lbs. • One-year warranty



Part No.	Product No.	Description	1	10
27131CD	M381	Vacuum vise	\$59.95	\$53.99

PANA VISE Electronic Work Center

- Circuit board holder, standard base, tray base mount, solder station, sponges and wire holder included
- Size: 8.5"W x 7.8"H
- Weight: 5.3 lbs.
- One-year warranty



Part No.	Description	1	5	10
27060CD	Electronic center	\$74.95	\$71.25	\$66.95

PANA VISE PV Jr. Vice

- Jaw opening: 2.8"
- Jaw size: 1" wide x 2" long
- Jaw heat tolerance: 350°F
- Vertical/horizontal jaw grooves
- Fine/course adjusting knob
- The vise neck tilts, turns and rotates
- Vise height: 6.8"
- Base bolt is 4.3" and fits all PanaVise base mounts
- Weight: 1.4 lbs.
- One-year warranty



Part No.	Description	1	10
134439CD	Jr. vice w/ mountable base	\$19.95	\$18.95

Third Hand

- Frees hands for soldering
- Two adjustable arms with alligator clip jaws
- 2" diameter magnifying lens
- Quick and easy rotation
- Sturdy, heavy base
- Weight: P/N 26690: 0.7 lbs.; P/N 72864: 1.4 lbs.



Part No.	Description	1	10	50
26690CD	Third hand	\$5.95	\$5.35	\$4.79
72864CD	W/ soldering holder	7.95	7.19	6.49

Soldering Tip

What is the correct way to solder?

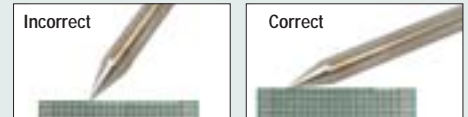

Follow these three steps:

Step One: The connection to be soldered must be clean. A small file, sanding pen or steel brush can be used if needed. A good soldered connection also requires a good mechanical connection. Make sure that wires are firmly attached to terminals or each other before soldering.

Step Two: When using a new soldering tip, coat the tip with solder to prevent oxides from forming, then immediately brush off the excess with a soft cloth to form a smooth, silvery soldering surface. This process is referred to as "tinning".

Step Three: Apply tapered surface of the soldering iron tip to the connection (see picture above). Allow connection to become hot, then apply solder. Don't use the point to melt solder – let the connection melt it to avoid "cold" solder joints. When soldering delicate components, work quickly and use a heat sink to draw off damaging heat.

Anti-Static Equipment

Protective Coiled Grounding Wrist Strap

- Comfortable, adjustable Velcro wrist strap
- The coiled cord has banana plug and alligator clips
- Extended cord: 9' long
- Color: black



Includes: 1MΩ resistor for added safety

SALE

Part No.	Description	1	10	100
34551CD	Anti-static strap	\$6.49	\$5.85	\$5.29

3M Wrist Strap for Static Protection

- Rubberized wrist strap for comfort
- 1MΩ resistance for static dissipation
- Length: 5'
- Coiled cord with a banana plug and alligator clip
- Zipper-style mechanism adjustable to any size wrist



Part No.	Description	1	10	100
159257CD	Adjustable strap	\$7.95	\$7.39	\$6.99

Anti-Static Heel Strap

- Discharges static without restricting your mobility
- Ideal for anyone handling static sensitive devices
- Ground strap: 15.5"L



SALE

Part No.	Description	1	10	100
100327CD	Heel strap	\$7.25	\$6.53	\$5.95

Anti-Static Work Mats

Make your work environment safe from static discharge! These mats are made of attractive semi-conductive vinyl that provide adequate discharging, yet will not short leads or pins.



Includes: Grounding clip

Part No.	Dimensions	Wt. (lbs.)	1	10	100
10575CD	11.3" x 22"	0.7	\$8.95	\$7.95	\$6.95
10583CD	19.5" x 23.5"	1.1	\$13.95	\$12.59	\$11.35
168508CD	24" x 28"	1.8	\$18.95	\$17.09	\$15.35

3M Anti-Static Field Service Kit

This kit provides all the basic items needed to create a static-safe work environment for field service work.



Includes: Static-discharge work surface mat, adjustable wrist band and cord, mat ground cord, and alligator clip

Part No.	Description	1	10
159994CD	8506 Field service kit	\$38.95	\$34.95

We'll match the advertised price of any like product.

Jameco's Low-Price Guarantee

It's that simple!

Conductive Anti-Static Foam and Bags

Don't get zapped!

Protect your investment with these inexpensive bags and ensure a safe work area with our conductive anti-static foam.

- For safe storage of static sensitive devices

13864CD: 24.0"L x 12.0"W x 0.25"H

Part No.	Description	1	10	100
13864CD	Anti-static foam	\$7.95	\$6.95	\$6.15

78668CD: 4" x 6" anti-static bags19 .17 .16

78650CD: 8" x 10" anti-static bags .. .69 .62 .55

Anti-Static Plastic DIP IC Storage Tubes and Rubber Rail Stops

29516CD: Thin tube (rail) fits 8, 14, 16, 18, 20 and 22-pin integrated circuits. Length: 23.75"

29524CD: Wide tube (rail) fits 24, 28, 32, 40 and 48-pin integrated circuits. Length: 20"

29583CD: Rubber stops used to plug plastic rail ends



* Prepackaged: order in increments of 10 or 100

Part No.	Mfr. Cross Ref.	Description	1	10	100
29516CD	RIC20	Thin rail	\$.59	\$.40	\$.29
29524CD	RIC220	Wide rail	.29	.25	.15
29583CD	RRS	Rubber stop	*	.07	.06

Professional Electronic Technician Tool Kits for Every Situation!

25-Piece Field Repair Tool Kit

Two-in-one design allows user to carry a tool case and a briefcase in one. Features a separate case for tools that attaches to the briefcase with zippers.

- In addition to the tools listed in the matrix below, the kit includes:
 - 5" snipe nose pliers
 - Alignment driver
- Size: 14.2"W x 11.0"D x 4.7"H • Weight: 6.6 lbs.



Part No.	Description	1	5
218211CD	Master electronic tool kit	\$66.95	\$58.95

28-Piece Cellular Phone Services Tool Kit

This kit is perfect for mobile phone repair.

- In addition to the tools listed in the matrix below, the kit includes:
 - 4" micro cutting pliers
 - 5" snipe nose pliers
 - Hot air tip
 - Self igniting micro torch
 - S-needle tip
- Size: 11.9"L x 9.8"W x 1.9"H • Weight: 3.2 lbs.



Part No.	Description	1	5
218202CD	Cellular phone tool kit	\$66.95	\$59.95

51-Piece Tech Tool Kit

Essential Kit for Electronic Machine Maintenance and Repair Jobs!

- In addition to the tools listed in the matrix below, the kit includes:
 - 2 nut drivers
 - Solder pen
- Case features removable pallets, a combination lock and a cushioned black plastic handle
- Size: 12.5"L x 17.5"W x 3.5"H • Weight: 10.4 lbs.



Part No.	Description	1	5
26681CD	51-piece tool kit	\$99.95	\$89.95

27-Piece Technician's Tool Kit

All the essential technician's tools in a durable canvas carrying case.

- In addition to the tools listed in the matrix below, the kit includes:
 - 5" precision range side cutting pliers
 - 5.3" precision range long nose pliers
 - Solder wick
 - Alignment driver
 - Nut screwdriver (1/4")
- Size: 16.2"W x 13.0"D x 3.0"H • Weight: 7.1 lbs.



Part No.	Description	1	5
218229CD	Technician's tool kit	\$115.95	\$104.95

55-Piece Tech Tool Kit

An assortment of tools for general & precision work for technicians, engineers, students, etc.

- In addition to the tools listed in the matrix below, the kit includes:
 - Screwdriver handle
 - 6-piece mini-hammer set
 - 5 piece of double edge blade
 - PLCC extraction tool
- Carrying case has outer velcro pockets to store paperwork, etc.
- Complete your assortment with a multimeter (See pages 0-0)
- Size: 17.6"L x 12.8"W x 4.0"H • Weight: 9.2 lbs.



Part No.	Description	1	5
136311CD	55-piece tool kit	\$129.95	\$116.95

57-Pc. Master Electronics Tool Kit

Simply every tool needed for field repair or installation. All in a handsome lockable case, with room for spare parts or special equipment.

- In addition to the tools listed in the matrix below, the kit includes:
 - 5" & 6" side cutter
 - 5" & 6" long nose pliers
 - 8" combination pliers
 - 9.5" water pump pliers
 - Testing driver
 - Alignment driver
 - Solder wick
 - Parts tube
 - PVC insulated tape
 - 5-piece file set
 - Oil can
 - 6" stainless scissors
 - Carpenter hammer
- Carrying case has two removable pallets, adjustable compartments, and combination locks
- Size: 18.0"W x 13.0"D x 4.0"H • Weight: 16.0 lbs.



Part No.	Description	1	5
218245CD	Master electronic tool kit ...	\$131.95	\$117.95

Quick-Reference of Professional Tool Kit Contents

Parts included in kits	218211CD	218229CD	218202CD	26681CD	136311CD	218245CD	105646CD	149024CD
3-prong holder					1	1	1	1
Anti-static strap					1		1	1
Brush		1		1		1	1	1
Crimping tool		1 (7-way)			1 (7-way)	1	1	1 (5-way)
Desoldering pump	1	1		1	1	1	1	1
Digital Multimeter		1		1			1	
Drill set							1	1
Files, needle		2-pc		2-pc				
Flashlight		1			1	1	1	1
Forceps								1
Heat sink					1	1	1	1
IC extractor	1	1			1	1	1	1
Inspection mirror						1		1
Measuring tape, 10-foot	1			1		1		1
Pliers, 8" lineman	1 (6")				1		1	
Pliers, bent needle nose				1	1	1	1	1
Pliers, diagonal cutter	1			1	1	1	1	1
Pliers, flat nose				1	1	1	1	1
Pliers, needle nose								
Pliers, snipe nose			1					1
Scissors				1		1	1	
Screwdriver set	6-pc	7-pc	12-pc	8-pc	3-pc	8-pc	11-pc	40-pc
Screwdrivers, precision			2-pc	6-pc	6-pc	6-pc	6-pc	6-pc
Solder core	1	1	1		1	1	1	1
Soldering aid kit, 3-pc			1 (6-pc)	1	1	1	1	1
Soldering iron	1 (30W)	1 (30W)		1	1 (30W)	1 (30W)	1 (30W)	1 (25W)
Soldering stand		1		1		1	1	
Tape, electrician		1					1	
Tweezers	1	1	1	1	2	1	1	1
Utility components box		1		1		1	1	1
Utility knife	2-in-1	1			1	1	1	
Wire stripper								1
Wrench, adjustable	1	1			1	1	1	1
Wrench, hex key	7-pc	7-pc		7-pc	7-pc	7-pc	7-pc	7-pc
Wrench set						6-pc	10-pc	10-pc
Total Pieces	25	27	28	51	55	57	66	69
Price	\$66.95	\$115.95	\$66.95	\$99.95	\$129.95	\$131.95	\$179.95	\$259.95

66-Piece Tech Tool Kit

Kit for Field Technicians and Engineers!

- In addition to the tools listed in the matrix left, the kit includes:
 - Computer/polarity circuit tester
 - Mini vacuum cleaner
 - Cassette head cleaning fluid
 - Keyboard/monitor spray cleaner
 - Long nose pliers with cutter
 - Hobby vice
- Aluminum case features removable pallets, surface-type locks, a black plastic handle, side buckles and a strap.
- Size: 18.0"L x 14.0"W x 6.0"H • Weight: 15.5 lbs.

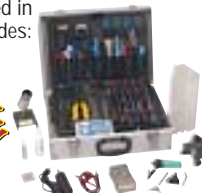

Part No.	Description	1	5
105646CD	66-piece tool kit	\$179.95	\$164.95

69-Piece Tech Service Tool Kit

- In addition to the tools listed in the matrix left, the kit includes:
 - 40-pc socket pack
 - 6" side cutter
 - 6" long nose plier
 - 6" slip joint plier
 - carpenter hammer
 - 3 piece trimmer set
 - stainless steel spring hook
 - solder wick
 - 8" combination plier
 - 2 removable pallets
- Size: 18.5"L x 13.8"W x 6.7"H • Weight: 22.8 lbs.



Part No.	Description	1	5
149024CD	69-piece tool kit	\$259.95	\$235.95

Economy Tool Kits for Every Budget!

8-Piece Compact Tool Kit

The perfect size and tools for quick repairs.

- 5" side cutter
- 5" long nose pliers
- PRO-SOFT 3 x 75mm slotted screwdriver
- PRO-SOFT #0 x 75mm Phillips screwdriver
- Stainless tweezers
- Solder core • Desoldering pump
- Portable gas soldering iron with torch tip
- Size: 8.1"L x 5.7"W x 1.4"H • Weight: 1.2 lbs.



Part No.	Description	1	5
218181CD	8-piece compact tool kit	\$21.95	\$19.95

10-Piece Electronic Tool Kit

Ideal for repairing electronic devices and perfect for the electronic enthusiast.

- #0 Phillips and 3mm slotted screwdrivers
- Precision Phillips and slotted screwdrivers
- Stainless steel tweezers
- Flat and round needle files • Utility knife
- 5" side cutter and long-nose pliers
- Size: 7.7"L x 3.7"W x 1.3"H • Weight: 0.8 lbs.



Part No.	Description	1	5
226077CD	10-piece electronic tool kit ..	\$14.95	\$14.19

11 & 12-Piece Lightweight Computer-Service Tool Kits

- Both kits include:
 - 2 nut drivers: 3/16", 1/4"
 - 3-claw parts holder
 - 1-pc hex key wrench
 - IC extractor
 - 4-pc screwdriver set
 - Tweezers

167206CD: 11-Piece Tool Kit

- In addition this kit includes:
 - Clear components, tube holder
- Size: 8.5"L x 5.9"W x 1.3"H
- Weight: 1.1 lbs.



167206CD

14189CD: 12-Piece Tool Kit

- In addition this kit includes:
 - 14-16 pin IC inserter/straightener
- Size: 9.0"L x 5.8"W x 1.3"H • Weight: 1.2 lbs.



14189CD

Part No.	Description	1	10	25
167206CD	11-piece tool kit	\$12.95	\$11.49	\$9.95
14189CD	12-piece tool kit	14.95	13.49	11.95

20-Piece SAE Computer Tool Kit

- The kit includes:
 - 1-pc hex key wrench
 - 30W soldering iron
 - Adjustable wrench
 - Needle nose plier
 - 6-pc screwdriver set
 - 6" solder – Tweezers
 - 8" wire cutter/stripper
 - Clamping tweezers
 - 3-pronged parts retriever
 - Spare parts tube – IC extractor
 - Flashlight with battery – Heavy duty molded case
 - 2 nut drivers (1/4" & 3/16")
- Size: 11.9"L x 9.2"W x 2.0"H • Weight: 3.5 lbs.



Part No.	Description	1	10	100
170966CD	Computer tool kit	\$28.95	\$25.95	\$22.95

24-Piece PC Premium Tool Kit

- 3.2mm x 75mm slotted screwdriver
- #0 x 75mm Phillips screwdriver
- 3 prong holder
- Spring tweezers
- Spare parts tube
- IC extractor • Torch
- Extension bar for ratchet bits
- Adjustable ratchet screwdriver
- Side cutter pliers • Long nose pliers
- 5mm and 7mm slotted bit
- #1 and #2 Phillips bit
- T10, T15, T20, T25, and T30 torx bit
- 1/4" and 3/16" nut • Socket adapter
- Size: 8.4"L x 5.9"W x 1.4"H • Weight: 1.3 lbs.



Part No.	Description	1	5
2226085CD	24-piece premium tool kit	\$19.95	\$18.95

26-Piece SAE Hobby Tool Set

- 4-1/2" long nose pliers
- 4-1/2" diagonal cutting pliers
- #1 & #2 Phillips bits
- #1 & #2 pozi bits
- 3/16" & 1/4" slotted bits
- Hex to 1/4" driver adapter
- T-10, T-15, and T-20 TORX bits • Tweezers
- Driver handle • Compact carrying case
- 3" extension bar for 1/4" drive
- 3 slotted and 3 screw driver precision set
- 3/16", 1/4", 11/32" and 3/8" sockets for 1/4" drive
- Size: 12.0"L x 9.0"W x 2.0"H • Weight: 1.5 lbs.



Part No.	Description	1	10	25
170069CD	26-pc. SAE tool set ..	\$14.95	\$12.95	\$10.95

26-Piece Metric Hobby Tool Set

- 6 screwdrivers: Phillips #0, #1, slotted 0.05", 0.08", 0.09", 0.12"
- 10 bits: 5mm, 6mm, #No.1, #No.2, No.1, No.2, T-10, T-15, T-20, socket adapter
- Stainless steel tweezers • Sockets: 5, 6, 8, 10mm
- Extension bar • Handle • 4" side cutter
- 4" long nose pliers • Plastic carrying case
- Size: 6.4"L x 4.1"W x 2.0"H • Weight: 1.2 lbs.



Part No.	Description	1	10	25
99629CD	26-piece tool set	\$9.95	\$9.45	\$8.95

40-Piece Electronic Tech Tool Kit

- The kit includes:
 - Wire cutters/stripper
 - Adapter bit for sockets
 - Pocket clip screwdriver
 - Potentiometer alignment tools
 - T10-T25 reversible TORX screwdriver bits
 - 3/16"-1/2" S.A.E. nut driver sockets
 - 6mm-12mm metric nut driver sockets
 - Slotted and Phillips screwdriver bits
 - 10-pc screwdriver set
 - Extra long 3-claw parts holder
 - IC inserter w/ pin straightener – IC extractor
- Size: 9.5"L x 6.8"W x 1.4"H • Weight: 1.7 lbs.



Part No.	Description	1	10	25
119183CD	40-piece tool kit	\$19.95	\$17.95	\$15.95

Professional Tool Case

- Aluminum framed
- Padded interior and adjustable dividers (6 sections)
- Detachable tool organizer for easy access
- Color: black with aluminum trimmings
- Size: 18"L x 13"W x 6"H
- Weight: 8.1 lbs.



Part No.	Description	1	10
149016CD	Professional tool case	\$37.95	\$33.95

17-Piece Offset Ratchet and Socket Driver Set

This offset ratchet and socket driver set includes 6 hexagon sockets made from quality hardened carbon steel. The handle features a 1/4" male head drive to accommodate the accompanying bits and sockets.



- Slotted bits: 4, 5 and 6mm
- Phillips bits: #1 and #2 • Pozi bits: #1 and #2
- TORX bits: T10, T15 and T20
- Hex sockets: 3/16", 7/32", 1/4", 5/16", 11/32" & 3/8"
- Reversible driver handle with 1/4" male head

Part No.	Description	1	5
226069CD	Offset ratchet & socket	\$7.49	\$7.19

29-Piece 1/4" Driver Socket Wrench Set

- Flank driver socket (6 pt): 4, 4.5, 5, 5.5, 6, 7, 8, 9, 10, 11, 12 and 13mm
- Slotted bit: 4, 5.5 and 7mm
- Hex bit: 3, 4, 5, 6 and 8mm
- Phillips bits: #1 and #2 • Pozi bits: #1 and #2
- 2" extension bar • Sliding T bar
- Universal joint • Extension bar with spinner handle
- Pear-type ratchet handle with quick release
- Size: 8.7"L x 4.3"W x 1.6"H • Weight: 1.8 lbs.



Part No.	Description	1	5
226229CD	1/4" driver socket	\$29.95	\$28.49

6-Pc Precision TORX Screwdriver Set

- T5 and T6 x 50mm TORX screwdriver
- T7, T8, T9, T19 x 50mm TORX hex screwdriver



Part No.	Description	1	5
226106CD	Precision TORX screwdriver	\$12.95	\$12.29

11-Pc Precision Screwdriver Set

- 0.9, 1.2, 1.4, 1.8, 2.4 and 3mm slotted screwdrivers
- Phillips #00, #0 and #1 screwdriver
- Awl
- Magnetic pick-up



Part No.	Description	1	5
226093CD	Precision screwdriver	\$4.49	\$4.29

Ballpoint Allen Hex Socket-Type Screwdriver Set

- Unique ballpoint tip ideal for tightening and removing Allen socket screws in hard-to-reach spots
- Will engage screw-heads from any angle
- Ends are precision-machined to close tolerances to help slip easily into sockets and hold securely without reaming
- Clear plastic case



Ballpoint tip

Kit includes: 99X5 extension, 991 handle, 9 pcs of 4" long blades (.05, 1/16, 5/64, 3/32, 7/64, 1/8, 9/64, 5/32, 3/16)

Part No.	Description	1	5
217859CD	11-piece screwdriver set	\$64.95	\$61.79

Flat-Tip Allen Hex Socket-Type Screwdriver Set

- Inch sizes
- Clear plastic case

Kit includes: Regular handle, extension bar, .05, 1/16, 5/64, 3/32, 7/64, 1/8, 9/64, 5/32, 3/16 blades



Flat-tip

Part No.	Description	1	5
217912CD	11-piece screwdriver set	\$43.95	\$40.95

Xcelite® 9-Piece Screwdriver Set

- Handles more jobs with fewer tools, saves bench space and lightens service kits
- Equipped with remarkable black, "piggyback" torque amplifier handle
- Color coded handles
- Inch sizes
- Clear plastic case



Kit includes: Green 3/32", red 1/8", black 5/32", orange 3/16", amber 1/4", blue #0 Phillips, brown #1 Phillips, amber #2 Phillips, and black torque amplifier handle

Part No.	Description	1	10
218069CD	9-piece screwdriver set	\$27.95	\$26.29

6-Pc Long-Neck Screwdriver Set

- Three slotted: 0.09"Dia. x 6.6"L, 0.12"Dia. x 6.6"L, 0.16"Dia. x 9.6"L
- Three Phillips: No.0, 0.12"Dia. x 6.64"L; No.1, 0.16"Dia. x 9.61"L; No.2, 0.09"Dia. x 6.65"L



Part No.	Description	1	10	50
99451CD	6-pc. screwdriver set	\$7.95	\$6.95	\$6.25

6-Pc Precision Screwdriver Sets

34041CD includes: 3/64", 1/16", 5/64", 5/32", 1/8" and 9/64" slotted screwdrivers

34059CD includes: 3/64"#0, 1/16"#0, 5/64"#0, 3/32"#0, 1/8"#1 and 9/64"#1 Phillips screwdrivers



Part No.	Description	1	10	50
34041CD	Slotted screwdriver set	\$3.95	\$3.49	\$2.95
34059CD	Phillips screwdriver set	3.95	3.49	2.95

Flexible Ratchet Driver Set

With the mini-ratcheting handle and 7.5" flexible shaft, you can loosen or tighten those hard-to-reach screws.

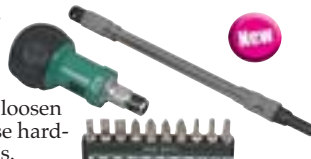

Includes: Flexible shaft (190mm), mini ratchet handle that has forward, reverse and conventional settings, slotted bits (4mm, 5mm & 6mm), Phillips (#1 & #2 bits), Pozi (#1 & #2 bits), and TORX (10, 15 & 20mm bits)

Part No.	Description	1	5
223802CD	Ratchet drivers set	\$7.95	\$7.39

6-Piece Screwdriver & Pliers Set

- One micro cutting nipper
- One micro flat nose pliers
- 2 long-neck slotted: 0.12"Dia. x 9.61"L; 0.09"Dia. x 7.64"L
- 2 long-neck Phillips: No.0, 0.12"Dia. x 9.61"L; No.2, 0.09"Dia. x 7.64"L



Part No.	Description	1	10	50
99565CD	Screwdriver/pliers ...	\$14.95	\$13.49	\$11.95

JAMECO Pocket Screwdriver

Phillips/Flat head

- Pocket screwdriver with Phillips and slotted
- Pen clip for pocket storage
- Size: 6"L



Part No.	Description	1	10	100
127271CD	Pocket screwdriver	\$1.55	\$1.45	\$1.19

Xcelite® Needle Nose Pliers



217891CD 217963CD 217998CD

- 217891CD:** Serrated jaws
- Positive gripping of fine wire or subminiature components
- Fine point allows use in confined areas
- 217963CD:** Fine serrated jaws
- General purpose
- 217998CD:** Smooth jaws
- General purpose for pick-up and wire forming

Part No.	Description	1	10
217891CD	4" submini needle nose	\$14.95	\$13.69
217963CD	5.5" thin long nose	16.95	15.49
217998CD	5" thin long nose	16.95	15.79

Xcelite® 6-Piece Pliers Kit

- A compact kit designed for an electronics technician or dedicated hobbyist
- Durable pocket-pouch with heavy-duty snaps
- Each professional quality tool features the unique Copaloy rivet for smoother action



Kit includes: 4.5" transverse end-cutting pliers, 4" diagonal-cutting pliers, 5" long-nose pliers with side cutters, 5" fine-tip needle nose pliers, 5" flat-nose pliers, and 5" long-nose pliers

Part No.	Description	1	5
218051CD	6-piece pliers kit	\$109.95	\$103.89

Retaining Ring Pliers

SALE

Internal/External

- Black oxide finish
- Hi-carbon tempered steel
- Vinyl grip
- Length: 6"
- For 0.47" to 0.98" diameter retaining rings



Part No.	Description	1	10
177551CD	Retaining ring pliers	\$5.95	\$5.39

Linesman Pliers

SALE

- Drop forged steel
- Heat treated
- Milled jaws
- Vinyl grips
- Polished head
- Length: 8"
- Weight: 0.9 lbs.



Part No.	Description	1	10	50	100
177594CD	Linesman pliers	\$4.25	\$3.85	\$3.49	\$3.15

Half-Round Long Nose Pliers

- Drop forged steel
- Heat treated
- Spring return action
- Vinyl grips
- Length: 4.5"
- Knurled jaws

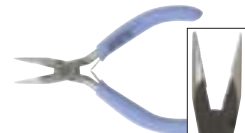

Part No.	Description	1	10	50	100
177607CD	Half-round pliers	\$4.95	\$4.49	\$3.95	\$3.59

5.3" Flat and Half-Round Long Nose Pliers

- Stainless steel
- Spring return
- Durable rubber handles
- 5.3" length w/ 1.4" plier nose
- 35473CD/35490CD:** Knurl jaws
- 195531CD:** Smooth jaws



Part No.	Description	1	10	50	100
35473CD	Flat long nose	\$5.49	\$4.99	\$4.49	\$3.49
195531CD	Flat long nose	4.95	4.49	3.95	3.49
35490CD	Half round	4.95	4.49	3.95	3.49

Precision 5-Piece Stainless Steel Pliers Set



- Spring return
- Insulated handles
- Includes:** One 3.5"L micro cutting nippers and one each 4"L micro round nose pliers, long nose pliers, flat nose pliers and bent nose pliers

Part No.	Description	Wt. (lbs.)	1	10	25
73120CD	5-piece set	0.6 ...	\$16.95	\$14.95	\$13.49

Xcelite® Cutters and Pliers



Part No.	Product No.	1	10	50	100
146712CD	170M	\$5.95	\$5.35	\$4.79	\$4.29
146739CD	MS54V	13.95	12.95	11.95	10.95
146721CD	MN7776V ...	16.95	15.95	14.95	13.95

Xcelite® Diagonal Cutters

Manufactured from the finest forged alloy steel with polished head and cushion comfort handles, these cutters are designed for the demands of engineers and manufacturing environments.

- Flush or semi-flush cutting edge handles most cutting requirements
- Cutting edges machine ground and electronically hardened for extended life
- Forged alloy steel w/ polished head for high durability
- Patented COPALLOY rivet construction provides smooth operation and long life
- Handle coil springs for fast cutting action
- ESD safe cushion grips for maximum comfort

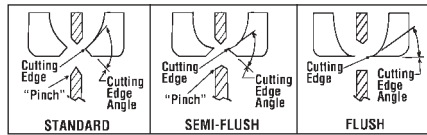

Choose the finished cut best for your projects

Expanded Xcelite Professional Tools

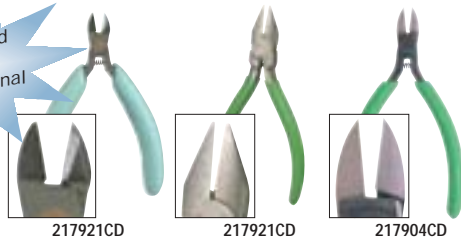

217904CD: Flush cutting of leads in restricted spaces; narrow tip gives increased clearance

217955CD: Used for cutting component leads

Part No.	Description	1	10
217921CD	4" oval head-flush cut	\$16.95	\$15.49
217955CD	4" relieved head-flush cut	15.95	14.85
217904CD	4" tapered head-flush cut	15.95	15.19
217867CD	4" slim line tapered head-flush cut	15.95	14.69
218034CD	4" slim line tapered semi-flush cut	15.95	14.85

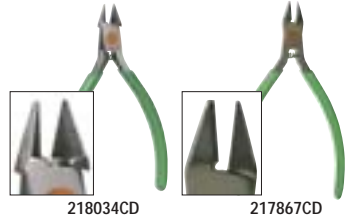

Xcelite® Shearcutter/Pliers Set

- Improved handle grip for control and comfort
- Non-glare black finish carbon steel
- Size (plier): 5.6"L
- Size (shearcutter): 5.2"L

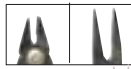

Part No.	Description	1	10	25
152055CD	Cutter/pliers set (S2K)	\$15.95	\$14.95	\$13.95

4" Diagonal Wire Cutter

- Drop forged steel
- Heat treated
- Vinyl grips
- Spring return action
- Polished head
- Length: 4"



Part No.	Description	1	10	50	100
179901CD	Wire cutter	\$4.95	\$4.49	\$3.95	\$3.59

4.3" Diagonal Wire Cutter

- Cuts component wire up to 1.2mm thick
- Stainless steel
- Durable rubber handles
- Jaws are designed for flush cutting
- 4.3"L x 2.1"W with 0.5" cutting blade



Part No.	Description	1	10	50	100
35481CD	Wire cutter	\$5.59	\$4.99	\$4.55	\$3.99

5" Diagonal Wire Cutter

- Cuts component wire up to 1.2mm thick and 0.08mm fine wire
- Insulated handles
- Jaws are designed for flush cutting
- 5.0"L x 1.8"W w/ 0.5" cutting blade



Part No.	Mfr. Cross Ref. No.	1	10	25
161411CD	Wire cutter	\$6.95	\$6.25	\$5.59

We'll Send It Today!

Just place your order by 6PM EST for same business day shipment.

5" Wire Cutter/Stripper

20-24 AWG Stripper

- Strips and cuts 20-24 AWG wires
- Insulated grips
- Spring loaded for easy use
- Cutter angled @ 45 degrees for use in tight places
- Size: 5.0"L x 3.0"W



Part No.	Product No.	1	10	50	100
159273CD	HT1091	\$4.95	\$4.49	\$3.95	\$3.59

5" Wire Cutter/Strippers

- Insulated handles
- Spring return
- Tempered steel cutting edge
- Size: 5.0"L x 3.0"W
- One-year warranty

78991CD



78991CD: 10-30 AWG (screw adjustable)
215888CD: 10-24 AWG (dial to adjust for wire gauge)

Part No.	Mfr. Cross Ref. No.	1	10	50	100
78991CD	HT108	\$3.95	\$3.49	\$2.95	\$2.59
215888CD	JE-2022C	3.95	3.49	2.95	2.59

6" Premium T5 & T6 Wire Strippers

- Contoured cushion-grip handles
- Wire size markings, in AWG and mm
- Size: 6.0"L x 2.0"W

161226CD: Premium T-5
• 10-18 AWG solid
• Color: yellow

161234CD: Premium T-6
• 16-26 AWG stranded
• Color: red

161218CD: Standard T-6
• 16-26 AWG stranded
• Color: red



Part No.	Prod. No.	Description	1	10
161226CD	ID45-215	T-5 10-18 AWG	\$15.95	\$14.49
161234CD	ID45-216	T-6 16-26 AWG	15.95	14.49
161218CD	ID45-121	T-6 16-26 AWG	13.95	12.95

Xcelite® 6.5" Snip Tool

- Shearing action of 1.5" cut pointed blades prevent peaks on fine wires and filaments
- Useful for removing insulation and cutting light sheet metal
- Coil spring opens blades
- Safety latch
- Plastic coated cushion grips provide maximum leverage

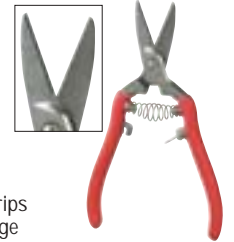

Part No.	Description	1	10
218026CD	Snip tool	\$29.95	\$28.15

6.6" Wire Stripper

22-30 AWG

- Wire stripper, cutter, steel wire cutter, and wire loop
- Scale: AWG and mm
- Strips and cuts wires from 20-30 AWG
- Size: 6.6"L x 2.0"W



Part No.	Product No.	1	10	50
159290CD	HT5023	\$8.95	\$7.95	\$6.95

7-in-1 Wire-Handling Tool

- Wire stripper, wire cutter, steel wire cutter, pliers and wire loop
- Solderless crimping tool
- Scale: mm and inch
- Size: 6.6"L x 3.0"W



Part No.	Prod. No.	Description	1	10	50
18796CD	HT104	10-18AWG	\$4.95	\$4.49	\$3.95
127861CD	HT1042	16-26AWG	4.95	4.49	3.95
127870CD	HT1043	22-30AWG	4.95	4.49	3.95

Rotary Coax Cable Strippers

2 and 3 Blade

- 159118CD (3 Blade):
2 settings RG58/59/62
• For cable sizes 4-10mm
• Size: 4.2"L x 1.3"W
• Color: black

- 159185CD (2 Blade):
4 settings RG58/59/62/174
• For cable sizes 4-12mm
• Size: 3.9"L x 0.7"W
• Color: gray



Part No.	Product No.	1	10	25
159118CD	HT312B (3 blade)	\$12.95	\$11.49	\$9.95
159185CD	HT332D (2 blade)	12.95	11.49	9.95

Automatic Wire Strippers

- 175097CD:
Strips 8-22 AWG wires
• Spring load grip
• Size: 7.0"L x 2.5"W
• Weight: 0.8 lbs.

- Includes: Wire stopper for desired strip length

- 202841CD:
Strips 3-24 AWG wires
• Size: 6.5"L x 3.0"W
• Weight: 0.3 lbs.



Part No.	Description	1	10	25
175097CD	Auto wire stripper	\$15.95	\$14.39	\$12.95
202841CD	Auto wire stripper	12.45	11.19	9.95

Crimp/Cut/Strip Tool

For RJ11 (6P) and RJ45 (8P) Modular Plugs

- Repeatable crimp action for consistent high-quality connections
- Push-down locking mechanism
- Size: 8.0"L x 2.0"W • Weight: 0.8 lbs.



Includes: Cut and strip blade

Part No.	Mfr. Cross Ref. No.	1	10
174684CD	TTK071	\$34.95	\$31.49

Telemaster Modular Connector Crimp/Cut/Strip Tool

For RJ11 (6P) and RJ45 (8P) Modular Plugs

- Repeatable crimp action for consistent high quality connectors
- Size: 6.0"L x 2.0"W
- Weight 0.8 lbs.



Includes: Cut and strip blade

Part No.	Prod. No.	Description	1	10
161091CD	ID30-496	Telemaster tool	\$41.95	\$37.95

Ratchet Crimp Tool

For RJ11 (6P) and RJ45 (8P) Modular Plugs

- Repeatable crimp action for consistent high-quality connections
- Size: 8.5"L x 2.2"W
- Weight: 1.2 lbs.



Includes: Cut and strip blade

Part No.	Mfr. Cross Ref. No.	1	10
174676CD	TTK070	\$42.95	\$38.95

Professional Modular Connector Crimping Tool

- Spring return action
- 6mm and 12mm stripping guide
- Crimp modular plugs without changing dies
- Crimps 10P10C, RJ45: 8P8C, RJ11 and RJ12: 6P6C, and 4P4C (Handset)
- Insulated handles • Size: 8.2"L • Weight: 1.2 lbs.



Part No.	Product No.	1	10	25
181147CD	HT200	\$57.95	\$53.95	\$48.95

Modular Connector Crimping Tool Set

- 8" metal modular crimping tool
- Cuts, strips and crimps
- Crimps RJ11 and RJ45 plugs
- Carrying case: blue hard plastic, 8.0"L x 10.5"W x 2.0"H
- Weight: 2.1 lbs.



Includes: 90 modular plugs, 40 pcs. 4P4C, 30 pcs. 6P6C, 20 pcs. 8P8C

Part No.	Product No.	1	10	25
73496CD	HT2000B	\$79.95	\$69.95	\$62.95

See page 134 for **NEW** Molex Hand Crimp Tool.

3-Piece Open-End Ratcheting Wrench Sets

The most useful development in open-end wrenches in 40 years. Most open-ended wrenches need a pivot angle of 60° to reinsert the wrench to make the next movement. The Alden Wrench needs only 30°, and with the built-in ratchet, you need not even remove the wrench from the head of the bolt or nut. Coupled with their small head sizes and ratcheting action, you can loosen or tighten a bolt faster and in tighter spaces than any standard combo wrench. It is made of stainless steel alloy widely used in aerospace and is individually hand polished.

- Weight: 0.6 lbs.
- 223896CD: SAE 3/8-7/8, 1/2-9/16, 5/8-11/16
- 223909CD: Metric 10-12, 13-14, 15-17



Part No.	Description	Price
223896CD	SAE	\$34.95
223909CD	Metric	34.95

33-Piece Ratchet Driver Set

High torque reversible ratchet handle with forward, reverse, and conventional settings. Magnetic shaft holds steel screws to bit for easy positioning. Bits can easily be stored in handle for easy transport.

- TORX bits: T6, T7, T8, T9, T10, T15 and T20
- Nut bits: 3/16", 1/4", 9/32", 5/16", 11/32" and 7/16"
- Hex bits: 1.5, 2.0, 2.5, 3, 4, 5, 6 and 8mm
- Pozi bits: #0, #1, #2 • Phillips bits: #0, #1, #2
- Slotted bits: 3, 4, 7 and 6.3mm • 50mm adapter
- Size: 9.1"W x 2.0"D x 7.6"H • Weight: 1.7 lbs.



Part No.	Description	1	5
226051CD	33-piece ratchet driver set	\$19.95	\$18.95

Metal Modular Connector Crimping Tool

- Cable stripper and wire cutter
- Size: 8.0"L
- Weight: 1.8 lbs.
- Crimps 6P and 8P plugs (6P2C, 6P4C, 6P6C, 8P2C, 8P4C, 8P6C, 8P8C)



Part No.	Description	1	10	25
114526CD	RJ11/RJ45	\$21.95	\$19.79	\$17.79

Ratcheted Modular Connector Crimping Tool

- Insulated grip
- Ratcheted type
- Metal • 7.5"L
- Crimps RJ45 (8P8C) and RJ11/12 (6P6C) • Weight: 0.7 lbs.

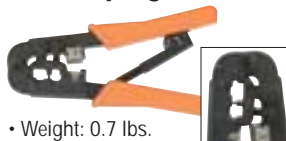

Part No.	Description	1	10	25
159311CD	RJ45/11/12	\$21.95	\$19.95	\$17.95

Twin Wrench Driver Set

The handle of this twin wrench driver set has two tips, horizontal and vertical for those hard-to-reach areas.



- Non-slip double ended driver
- Three slotted bits: 4mm, 5mm, and 6mm
- Phillips bits: #1 and #2 • Pozi bits: #1 and #2
- Torx bits: 10mm, 15mm, and 20mm

Part No.	Description	1	10
223811CD	Twin wrench driver set	\$3.95	\$3.59

Non-Insulated Terminal D-Sub Crimping Tool

14-26 AWG

- Heavy-duty metal crimping tool with cutter and insulated handles
- For computer pins and sockets, D-sub 26-28 AWG wire
- For butt-insulated connectors, 22-26 AWG wire
- For telephone spade lugs, 22-26 AWG wire
- For non-insulated connectors, 20-22 AWG wire
- For non-insulated connectors, 14-18 AWG wire
- Coiled spring return • Size: 7.3"L x 1.5"W



Part No.	Product No.	1	10	25	100
99442CD	HT202A	\$8.95	\$7.95	\$6.95	\$6.29

D-Sub Crimping Tool 20-28 AWG

- Crimps D-sub pins and sockets
- For use with P/Ns 43377CD, 43369CD, pg 125 and 100765CD, pg 127
- Size: 7.0"L x 4.0"W



Part No.	Product No.	1	10	25
159265CD	HT213	\$9.95	\$8.95	\$7.95

IDC Connector Crimping Tool

- Crimping distance: 27.5mm to 6mm (with attachment)
- Cushioned red handles
- Crimp insulation displacement connectors
- Use for IDC socket connectors, pg 126
- Size: 9.2"L x 3.0"W • Weight: 1.1 lbs.



Part No.	Product No.	1	10	25
73251CD	HT214	\$14.95	\$13.49	\$12.15

Solderless Terminal Crimping Tool

- Crimps solderless terminals: 18-22 AWG red, 14-16 AWG blue and 10-12 AWG yellow
- Size: 9.0"L x 2.0"W



Part No.	Product No.	1	10	25
72995CD	HT303	\$17.95	\$15.95	\$13.95

Ratcheted BNC Crimping Tool

- Crimps RG58, RG59, RG62, RG174 and fiber optic
- All steel construction
- Size: 8.5"L x 2.5"W
- Weight: 1.1 lbs.



Part No.	Product No.	1	10	25
114534CD	HT-3019	\$22.95	\$19.95	\$17.95

8-Piece Fold-Up TORX Key Set

- 3.7" long handle
- TORX bits: T9, T10, T15, T20, T25, T27, T30, T40
- Size: 3.7"L x 1.2"W



SALE

Part No.	Description	1	10	100
176006CD	TORX key set	\$9.95	\$8.95	\$7.95

Steel File Sets

- Strong tool steel
- 100360CD: 8-piece
- 5.65"L

- 1 ea. 0.15"Dia., 0.13"Dia., 0.12"Dia., 0.11"Dia. and four 0.22"Dia.

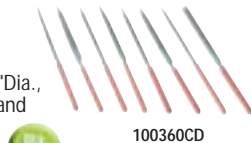

- 202833CD: 6-piece
- 5.5"L

- 1 ea. 0.12"Dia. (round), 0.11"W (triangle), 0.10"W (square), 0.20"W (half-round) and two 0.2"W (flat)

Part Number	Mfr. Cross Ref. No.	Description	1	10
100360CD	FS108F	8-piece file set	\$9.95	\$8.95
202833CD	08110	6-piece file set	6.95	5.59

Impact Punch-Down Tool

- Reversible clip-in blade
- Adjustable (HI-LO) spring-loaded impact mechanism
- Storage bin on handle for spare blade



175071CD

175071CD: Punch-down tool with blade

- For 66-type terminals
- Size: 5.2"L x 1.5"W x 1.0"H



175089CD: Punch-down blade

- Blade for 110-type terminals

175089CD

Part No.	Description	1	10
175071CD	Tool w/ 66 blade	\$39.95	\$35.95
175089CD	Punch-down blade 110	14.95	13.49

Impact Punch-Down Tool

Conforms to AT&T performance specification. Reversible clip-in blade, adjustable spring-loaded impact mechanism and spare storage blade in the handle.

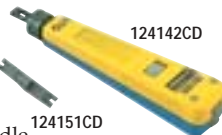

124142CD

124151CD

- One-year warranty

124142CD: For 66-type bifurcated terminals

- Size: 7.0"L x 1.4"W x 1.1"H

124151CD: Blade for 110-type terminals

Part No.	Description	1	10
124142CD	Tool with blade	\$49.95	\$44.95
124151CD	#110 blade	19.95	17.95

Rivet Tool

Sets 3/32", 1/8", 5/32" and 3/16" rivets without adjustments. Simply change the appropriate nozzle, slip the rivet into the pre-drilled hole, and you have a perfect fasten. Spring-loaded handle for automatic ejection of the mandrel.



226114CD

Part No.	Description	1	5
226114CD	Rivet tool	\$6.95	\$6.69
226288CD	1/8" x 1/4" long rivet (100 pk)	2.19	1.99
226296CD	3/16" x 1/4" long rivet (100 pk)	3.49	3.29

4-Way Master Key Chuck Tool

- Opens a variety of chucks (P/N 172911 opens 86 types); (P/N 172929 opens 127 types)
- Opens most chucks from manufacturers such as Cooper, Milwaukee, Craftsman, Black and Decker, and Rohm



- 172911CD: • Chuck size: 1/4" to 3/8" • Wt.: 0.3 lbs.
- 172929CD: • Chuck size: 1/2" to 3/4" • Wt.: 0.6 lbs.

Part No.	Description	1	10	25
172911CD	Opens 86 chucks	\$10.95	\$9.85	\$8.89
172929CD	Opens 127 chucks	8.89	8.09	7.35

1/4 - 1/2 Watt Resistor Lead Forming Tool

- Watt size indicates appropriate package size
- Bends lead length in .05" increments
- Excellent for capacitors also
- 1/4W: 0.4"-1.5"; 1/2W: 0.5"-1.5"; 5.4"L x 1.5"W



Part No.	Description	1	10	50
106884CD	1/4-1/2W	\$2.95	\$2.65	\$2.39

5" Steel Hemostats

- Grade 410 A.I.S.I. stainless steel
- Three locking positions
- Available with straight or curved tip



115107CD

Part Number	Mfr. Cross Ref. No.	Description	1	10	50
115107CD	HEM01	5" straight	\$3.95	\$3.49	\$2.95
115115CD	HEM02	5" curved	4.25	3.75	3.25

3-In-1 Tool

Measuring Tape, Knife, and Saw

Cut through drywalls, wood, PVC plastic, and paper. This 3-in-1 tool has a serrated saw on one side, a straight edge blade on the other and a detachable 6' measuring tape.

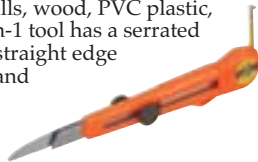

- Length: 8.4"

Part No.	Description	1	10
218641CD	3-in-1 tool	\$4.95	\$4.49

Deluxe Precision Knife Set

- Three different knife handles - fine work, medium and heavy duty power grip
- Size: 6.3"L x 2.8"W x 1.4"H



Includes: 13 different types of blades

Part No.	Description	1	10	25
72768CD	13 blade knife set	\$9.95	\$8.95	\$7.95

Glue Gun and Sticks

- Adheres to PCBs, cardboard, wires, metal and cloth
- Silicon nozzle
- Electronic heating
- Trigger action
- Utilizes long gluesticks (100mm)
- Size: 7.3"L x 6.3"W • Weight: 0.8 lbs.



72696CD

Part No.	Description	1	10	25
72696CD	Glue gun	\$10.95	\$9.95	\$8.95
78633CD	Glue sticks (6/pk)	2.95	2.69	2.29
176292CD	Glue sticks (10/pk)	4.95	4.29	3.79

Steel Fish Tapes

Fishing wires inside finished walls or through conduit is not fun. But with our steel fish tapes, you won't have to spend all day finishing the job. Designed specifically to make the retrieval of wires quick and easy.



- Impact resistant yellow ABS case won't rust or dent
- Finger grips around reel to ensure easy control
- Trigger provides constant-pressure tension while retracting

Part No.	Length	1	10	25
217470CD	50'	\$27.95	\$25.95	\$22.95
217488CD	100'	46.95	42.95	39.95
217496CD	200'	62.95	58.95	54.95

Magnetic Tip Measuring Tape

Measuring height or width with a regular tape measure is not easy, especially if you are working single-handed with metal materials. Typical end hooks will always slide out or will not hook properly. With this measuring tape, you can easily clamp on to metal surfaces with its magnetic hook and make precise height or width measurements.



- Magnetic end hook for convenient measuring and TRU ZERO function
- Blade with nylon coating for easy scale reading
- Anti slip and shockproof rubber case
- Heavy duty spring and blade system
- Tape measure length: 25'

Part No.	Description	1	10
215415CD	Magnetic tip tape measure	\$13.85	\$12.59

12-Piece Deluxe Hole Saw Kit

Cut smooth, accurate holes from 3/4" to 5" diameter in drywall, wood, plaster, aluminum, laminates, and plastic. With the 1/4" and 3/8" mandrels you can use it with any battery or electric drill.



- Hole saw diameters: 3/4", 7/8", 1 1/8", 1 1/4", 1 1/2", 1 3/4", 2", 2 1/2", 3", 3 1/2", 4", 5"
- 1/4" & 3/8" drive mandrels
- Allen wrench
- Size: 8.0"L x 6.0"W x 1.9"H
- Weight: 2.8 lbs.

Part No.	Description	1	10
211262CD	Hole saw kit	\$18.95	\$17.45

6" Drywall Saw

Ideal for cutting holes in drywall.



- Hardened tempered steel blade
- Sharp tip for plunge cuts
- Hard plastic handle

Part No.	Description	Price
224004CD	6" drywall saw	\$2.99

Spring-Hook Tools

Grab or place in position springs and wires in those hard-to-reach areas with these 8" long spring hook tools.



Part No.	Description	1	5
226042CD	Spring hooks	\$5.95	\$5.69

4-Piece Steel Tweezer Set



- 4 styles of stainless steel tweezers, one self-locking
- Ideal for picking up small components in hard-to-reach places

Part No.	Description	1	10	50
10735CD	4-piece tweezer set	\$7.95	\$6.95	\$5.95

Automatic Center Punch Tool

Adjustable

- Precision instrument
- Alloy steel point
- Knurled steel body • Size: 5.0"L x 0.5"Dia.



Part No.	Description	1	10	50
160282CD	Center punch tool	\$5.95	\$5.39	\$4.85

T-Handle Reamer Tool

Excellent for aluminum chassis work

- For enlarging starter holes on panel mount components from 1/8" to 1/2" diameter
- T-handle for easy rotation of tool
- Handle: 3.3" long, tool: 5.3" long



SALE

Part No.	Description	1	10	25
151749CD	T-handle reamer tool ..	\$8.59	\$7.79	\$6.95



Nibbling Tool

- Perfect for cutting, trimming, or notching sheet metal up to 18 AWG
- Time-saver when working on prototyping, chassis, and circuit boards
- Minimum .375" hole required • Size: 7.8"L



Part No.	Prod. No.	Description	1	10	25
18809CD	HT204	Nibbling tool ...	\$8.95	\$7.95	\$6.95
29330CD	HT204B	Replacement bit	4.95	4.49	3.95



Strip-Wrap-Unwrap Tools

- Tool tip made of tempered steel
- Use with 30 AWG wire on .025" square posts
- No solder necessary, see pg 121 for wire
- Spring steel cutter • 4.5" long
- Wrap 1 to 2 turns of insulated portion of wire for secure connections • Modified tool



Part No.	Product No.	1	10	25
34585CD	WSU30M	\$29.95	\$26.95	\$23.95

D-Sub Pin Insertion/Extraction Tool

- Insertion/extraction tool: red/white plastic body; exchangeable tips



Part No.	Description	1	10	100
19094CD	Insertion/ext. tool	\$3.49	\$2.99	\$2.59



BNC Connector Removal Tools

- For deep chassis removal
- Allows access to hard-to-reach places

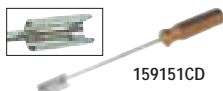

Part No.	Product No.	Size	1	10	25
159151CD	HT2206	6"L	\$8.95	\$8.09	\$7.25
152047CD	HT2212	12"L	14.95	13.49	11.95

32-Piece Security Bit Set

This security bit set contains most of the bits commonly used in today's electronic products to make them tamper resistant. Now you can open the cases of these products to repair them without damaging the case or screw.



- TORX bits: 4, 6, 8 & 10mm
- Tri-wing bits: #1, #2, #3 and #4
- Security hex bits: 2, 2.5, 3, 4, 5 and 6mm; 5/32", 9/64", 1/8", 7/64", 3/32" and 5/64"
- Security TORX bits: T8, T10, T15, T20, T25, T27, T30, T35 and T40 • 60mm magnetic bit extension

Part No.	Description	Price
223829CD	60-piece tool kit	\$11.95

Xcelite® Heavy-Duty Nut Driver Kit

This set of heavy-duty nut drivers are ideal for service/repair or manufacturing environments or anywhere you encounter small metric components.



- Metric • Red case
 - 31.35mm shaft hole depth
- Includes:** 4 thru 8, 10, 11 & 13mm

Part No.	Description	1	5
218042CD	Nut driver kit	\$59.95	\$55.95

IC Pin Straightener

Straighten bent pins safely and easily with Jameco's IC pin straightener.



- Straightens 8/14/16/18/20/24/28/40/42-pin ICs
 - Materials: black plastic • Size: 3.3"L x 1.5"W x 0.4"H
- Includes:** Ground terminal

Part No.	Description	1	10	100
99362CD	IC straightener	\$7.35	\$6.35	\$5.75



Electronic Inspection Set

- Bent mirror tool (0.1"Dia. x 6.8"L) – for visual inspection
- Sharp metal pick (0.1"Dia. x 6.0"L) – great for PCB re-work



SALE

Part No.	Description	1	10	25
72514CD	Electronic inspection ..	\$2.49	\$2.19	\$1.99

Trimmer Potentiometer Adjustment Pocket Tool

- Glass-filled body
- Stainless steel blade
- Size: 5.2"L



Part No.	Description	1	10	100
153314CD	Trimmer tool	\$1.19	\$0.99	\$0.89



Crimp Pin Extraction Tools

- Easily extract 0.093" locking pins from connectors
- Heavy duty metal
- Precision design
- Length: 5"



Part No.	Prod. No.	Description	1	10
131887CD	HT319C	Male tool for 42729CD ..	\$9.95	\$8.95
131879CD	HT319B	Female tool for 42649CD	9.95	8.95

60-Piece Bit, 1/4" Socket and Driver Tool Kit

This compact kit contains the most popular bits and 1/4" sockets with a comfortable cushioned, reversible ratchet driver handle.



- Drill bits: 1/16", 3/32", 1/8", 5/32", 3/16"
- Socket bits: 3/16", 7/32", 1/4", 9/32", 5/16", 11/32", 3/8", 7/16", 1/2", 5mm, 6mm, 7mm, 8mm, 9mm, 10mm, 11mm, 12mm, 13mm
- Phillips bits: #1, #2, #3 • Phillips Z bits: 1, 2, 3
- Slotted bits: 1/8", 5/32", 3/16", 1/4", 9/32"
- Hex bits: 5/64", 3/22", 1/8", 5/32", 3/16", 7/32", 1/4"
- Torque bits: T-10, T-15, T-20, T-25, T-30, T-40
- Square bits: 1, 2, 3 • 2.4" Magnetic bit adapter
- Reversible ratchet screwdriver
- 7.5" Flexible extension • Socket adapter
- 6" long nose pliers • 6" adjustable wrench
- Vinyl zipper case with organizer to find sizes fast
- Size: 8.5"L x 6.5"W x 2.2"H • Weight: 3.1 lbs.

Part No.	Description	1	5
218261CD	60-piece tool kit	\$36.95	\$32.95

6-Step Drill Tool

3/16" to 1/2"



Drill multiple holes in thin material with the same bit, faster and easier. Each bit does the work of many drill bit sizes. You can drill holes in most materials such as plastic, metal, and wood up to 1/8" thick. No center punching on most sizes. Made of high-speed steel.

- Drill size: 3/16" to 1/2"

Part No.	Description	1	10	25
172401CD	6-step drill	\$9.95	\$8.95	\$7.95

9-Piece Assorted Drill Bit Kit

- Variety of sizes: .014" to .126"
- Each kit will vary in contents of bit sizes
- Shank diameter: .125"



Includes: Plastic case

Part No.	Description	1	10	50
131676CD	9-piece drill bit kit	\$9.95	\$8.95	\$7.95

13-Piece Drill Bit Kit

- Sizes: 1/16", 5/64", 3/32", 7/64", 1/8", 9/64", 5/32", 11/64", 3/16", 7/32", 15/64", 1/4"

SALE



Includes: Plastic case

Part No.	Description	1	10
202850CD	13-piece drill bit kit	\$3.49	\$3.15

PC Board Drill Bits

- Reconditioned carbon steel bits
- High quality long lasting cutting edge
- Use for drilling holes in glass PC boards
- Shank diameter: .125"



SALE

Part No.	Drill Dia.	No.	Application	1	10	100
16619CD	.021"	75	Miscellaneous	\$1.39	\$1.25	\$1.15
16580CD	.040"	59	Plated thru holes	1.39	1.25	1.15

3X, 3-Bulb Adjustable Magnifying Lamp

Adjustable rectangular 3-diopter lens allows independent movement of the lens for best lighting and viewing angles. Three 9-watt compact fluorescent bulbs located to the side and top of the lens provide superior lighting to your workspace or job at hand.



The integral spring-balance arm reduces the chance of pinched hands from springs, and provides a sleek clean look.

- 47" long arm
- 2 on/off buttons
- Color: beige
- UL listed

Part No.	Description	1	10	25
217517CD	Adj. magnifying lamp	\$79.95	\$74.95	\$69.95

3X Rectangle Magnifying Lamp

3x diopter rectangular magnifying lens provides a large viewing angle and compact design.



With its two 7-watt fluorescent lamps located to the side of the lens, it provides superior lighting for any job. Enclosed springs in the arms reduce the chance of pinched hands and make it easier to clean.

- 47" long arm
- Color: beige
- UL listed

Part No.	Description	1	10	25
217509CD	Magnifying lamp	\$69.95	\$64.95	\$59.95

Tweezers w/ 8X Magnifying Glass

The perfect combination hand tool for professionals working with small objects. Magnifying glass stays in perfect focus with tweezer heads.



- Stainless steel construction
- Precision tip tweezers
- 1.2" diameter 8 diopter lens
- Length: 3.8"

Part No.	Description	1	5
217824CD	Tweezer magnifier	\$5.95	\$5.39

Wide View 2X Foldable Magnifier

This folding 2X magnifier is very popular among professionals needing a large-view magnifier plus the convenience of portability. Made of high-quality plastic, the frame is light with a precision glass lens. Easy-to-read scales in inches (scale of 1/16") and millimeters are etched on the base.



- Size (unfolded): 6.1"W x 5.3"D x 6.5"H

Part No.	Description	1	10
218296CD	Foldable magnifier	\$9.95	\$8.95

3X Magnifier with Adjustable Stand

- Heavy duty steel base
- Size: 15"L (full stand) x 4"Dia.(base)



Part No.	Description	Wt. (lbs.)	1	10
148881CD	Magnifier	2.5	\$13.29	\$11.99

3X Magnifying Lamps

- 45" extension arm
- Supplied with 22-watt circuline tube
- New wire clip design permits easy installation
- Extra strong, all-metal mounting base with electrical outlet
- Metal bulb holder for extra protection
- Power requirement: 110VAC/60Hz
- 3X magnification • Weight: 7.3 lbs.

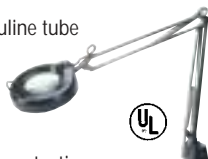

SALE

Part No.	Description	1	10	25
100829CD	Black lamp	\$59.95	\$53.95	\$49.95
149981CD	White lamp	59.95	53.95	49.95

Standard Adjustable 3X Magnifying Lamp

- 4" Diameter lens
- Maneuverable 30" arm extension
- Lamp tilts or turns in any direction
- Uses 60W incandescent bulb (not included)
- 3X magnification
- Power requirement: 110VAC/60Hz
- Weight: 2.9 lbs.



Part No.	Description	1	10	25
22710CD	Magnifying lamp	\$29.95	\$26.95	\$23.95

Precision 5X Magnifying Lamp

The arm extends to 40", is adjustable to any direction or angle, and has a 5X magnifying glass with built-in light. This is the perfect tool to help identify small electronic components and magnify a printed circuit board to help solder electronic components.



- 5" diameter lens • Weight: 7.1 lbs.
- Power requirement: 110VAC/60Hz

Includes: 22W circuline fluorescent bulb

Part No.	Description	1	10	25
197456CD	Magnifying lamp	\$109.95	\$98.95	\$88.95

General Purpose Illuminated 3X Magnifier

- 75mm diameter lens
- Great for magnifying fine print
- Light requires 2 AA batteries, see below
- Size: 7.5"L x 3.75"Dia.



Part No.	Description	1	10	25
149542CD	Illuminated magnifier	\$4.49	\$3.95	\$3.49
151087CD	1.5V AA battery (req. 2)	.25	.23	.21

Precision Micrometer

0"-1" Range ± .0001"

Forged steel frame precision micrometer is complete with chrome barrel and thimble for easy-to-read contrasting graduation. Hardened, precision-ground measuring surface with positive spindle lock holds measurements. Accurate to .0001". Quick and easy zero adjustment.



Part No.	Description	1	10	25
169543CD	Precision micrometer	\$12.95	\$11.69	\$10.49

Super Bright, Super Reliable LED Flashlight

The perfect tool for individuals who really depend upon a flashlight that always works. Containing space-age solid-state circuitry, batteries last 14 times longer than conventional flashlights and function continuously up to one month. Its super bright white LEDs will last at least 11 years.



- Waterproof, designed for all weather conditions
- Shockproof, withstands a drop from 4'
- Low cost per hour of operation
- Industrial grade switch, rated for 10,000 operations
- Rubber over-molding

215677CD: One month continuous operation using three "D" cell batteries (P/N 196998CD, pg 202)

215685CD: 25-days continuous operation using three "C" cell batteries (P/N 197000CD, pg 202)

215693CD: 14-days continuous operation using three "AA" cell batteries (P/N 185261CD, pg 202)

Part No.	Prod. No.	LEDs	Length	1	10
215677CD	LW-4000	10	10.6"	\$59.95	\$53.95
215685CD	LW-3000	7	8.9"	49.95	45.95
215693CD	LW-2100	4	7.9"	34.95	31.49

AA-Battery Flashlight

- Black hard plastic body
- Size: 6.0"L x 0.9"D



Requires: 2 AA batteries (listed below)

Part No.	Description	1	10	100
159812CD	GE flashlight	\$1.95	\$1.55	\$1.19
151087CD	AA batteries	.25	.23	.19

Digital Display Calipers

Metric or Inches

- Hardened stainless steel
- Display: inches to 1/1000THS mm to 1/100THS
- Resolution: 0.01mm (0.0005")
- Instructions for making internal, external, depth and step measurements
- Auto-off after 5 minutes
- Calipers measure to 6 inches/150mm
- Weight: 0.8 lbs. • One-year warranty



Includes: Fitted case and 1.5V silver oxide battery (replacement battery, P/N 140783CD, pg 202)

Part No.	Description	1	10	25
127482CD	Digital disp. calipers	\$59.95	\$53.95	\$48.95

Metal Dial Calipers

Metric or Inches

- For accurate measurements every time
- Measures outside, inside and depth
- Easy-to-read dial gauge
- Materials: metal
- Length: 6" (150mm)
- Color: silver
- Weight: 0.7 lbs.



Includes: Fitted plastic storage case

Part No.	Description (min. reading)	1	10	25
116134CD	Metric (.02 mm)	\$27.95	\$24.95	\$22.49
116126CD	Inches (.001 inch)	27.95	24.95	22.49

3M Portable Vacuum

Avoid inhaling tiny airborne toner particles that almost all vacuums blow out their exhaust. Designed for clean-up of hazardous material, 3M's Government Solutions Division has created this powerful 1HP/5A vacuum with a fully enclosed disposable HEPA filter providing 99.97% efficiency at 0.3 microns. Preferred by service professionals everywhere because of its portability and quick setup, the ingeniously designed compact heavy duty case is the vacuum. All attachments, the power cord, and even the 10' super stretch hose fit conveniently in the case. The motor has factory sealed ball bearings to stand up to even the most demanding tech professionals.

Includes: 10' super stretch hose, crevice nozzle, tubular nozzle, dusting brush and type 2 filter

Part No.	Product No.	Description	Size (L" x W" x H")	Wt. (lbs.)	1	5
219555CD	SV497AJM	Electronic portable vacuum with case	17.8 x 7.8 x 9.3	10.3	\$249.95	\$234.95
219563CD	SV497AJM	Type II filter for P/N 219555CD	—	—	21.95	19.95



Data VAC PRO Vacuum/Blower



The Data-Vac "PRO" Series has plenty of power for the toughest jobs plus a toner filter system that picks up dangerous toner spills from laser printers and copiers. So, the "PRO" is perfect for cleaning all types of office equipment—from micros to mainframes, laser printers, copiers, fax machines, disc drives, calculators, and automatic teller machines. **Includes:** 6' flexible hose, pik-all air pin pointer, crevice tool, snap in brush, soft bristle dusting brush, snorkel probe, air maximizer, adapter nozzle, flexible neck extension wand, micro dusting brush and micro crevice tool

Part No.	Description	1	5
219213CD	Data VAC PRO vacuum	\$148.95	\$139.95
219248CD	Carrying case	57.95	55.95
219230CP	Toner replacement bags (5pk)	34.95	29.95
219221CD	Disposable paper bags (5pk)	5.95	5.49

Powerful Cordless Screwdriver Set

Save time and your wrist with those stubborn screws. This 4.8 Volt rechargeable cordless screwdriver features a spindle lock for greater control and a 180 RPM motor that produces 40 in.-lb. of torque for starting and finishing screws. Comes with 2 magnetic bit holders, 11-piece bit set (5 slotted, 3 Phillips, 3 torque), and power supply at no extra cost.

- Narrow nose for extended reach in tight places
- Construction grade quality
- Recharges in 7 to 9 hours
- Size: 10.5" long
- Weight: 1.4 lbs.

Part No.	Description	1	5
211254CD	Cordless screwdriver	\$18.95	\$17.95



Cordless Screwdriver

- Adjustable handle can be used folded or unfolded
- Thumb switch for reverse and forward action
- No load speed: 180 RPM
- Clutch operating torque from 4 to 21kg-cm
- 3.6V rechargeable battery
- Size: 10.5"L x 1.5" Dia.
- Weight: 1.6 lbs.

Includes: 6VDC @ 300mA power supply and screwdriver bits, slotted and Phillips

Part No.	Description	1	10
176680CD	Cordless screwdriver	\$39.95	\$35.95



Variable High-Speed Rotary Tool Kit

A multiple high-speed rotary tool kit with a 6-speed selection knob ranging from 8,000 to 30,000 RPM, along with the 40-piece accessories, provides you all the power and precision you need to tackle almost any cutting, drilling, polishing, sanding or engraving job. With its high-speed and low torque output, plus a nylon body, you can grasp the tool lightly to perform fast rough work or delicate craftsmanship. A convenient shaft-lock button provides fast-and-easy accessory bit changing.

For accessory bits for the rotary tool see page 225

Part No.	Description	1	5
211289CD	Rotary tool	\$44.95	\$42.95



Mini-Drill and Stand

This Mini Drill is excellent for drilling through circuit boards and protoboards. The drill comes with an array of drilling, grinding and sanding attachments. Drill stand is designed to function like a drill press.



Part No.	Description	Wt. (lbs.)	1	10	25
26702CD	MS398 drill	0.8	\$29.95	\$26.95	\$23.95
26711CD	MS399 stand	1.8	19.95	17.95	15.95

These heavy-duty, all-in-one multi-tools are really handy for do-it-yourself users, students, handy-men, and sportsmen. Folded, they fit in the palm of your hand or slip into a sheath on your belt. Just the tools you need for everyday use!

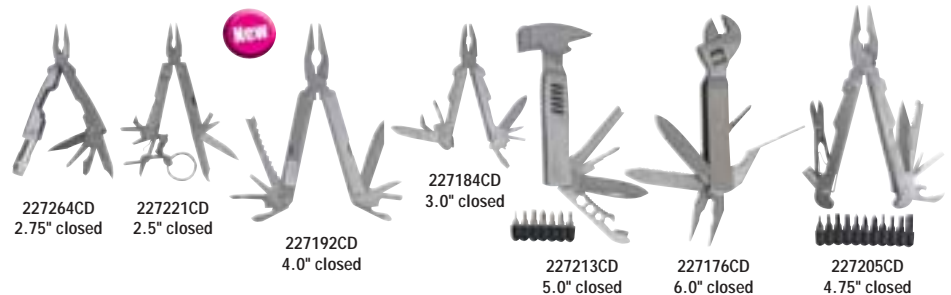

	227264CD	227221CD	227192CD	227176CD	227213CD	227205CD
Accessory bits						
Adjustable wrench		1			7	11
Awl			1	1		1
Can/bottle opener	1 (bottle)		2	2	2	2
File (wood/metal)	1 (metal)		1 (metal)	1 (metal)		
General screwdriver handle					1	1
Flashlight	1					
Hammer, nail remover						2
Hex nuts					1	3
Knife blade	1	1	1	1 (small)	1	1
Nail pick	1		1			
Pliers, regular		1			1	
Pliers, handyman/long-nose	2	2	1	2	2	2
Ruler				1		
Saw		1				1
Scissors			1			1
Screwdriver, flat head		1 (large)	1 (small)	3 (S, M, L)	2 (S, M)	
Screwdriver, Phillips	1	1	1	1	1	
Wire cutter	1	1	1	1	1	1
Description	9-in-1	9-in-1	11-in-1	13-in-1	14-in-1	19-in-1
Pricing	1	1	1	1	1	1
	\$11.95	\$19.95	\$11.95	\$19.95	\$19.95	\$19.95
	5	10.95	18.95	10.95	18.95	18.95

ATX 150-Watt

- Output:
 - +3.3V @ 6A
 - +5V @ 10A
 - +12V @ 6A
 - +5VSB @ 0.72A
 - 5V @ 0.2A -12V @ 1A
- 20-pin ATX form factor
- Mating input connector: suggest using P/N 38050CD power cord, pg 49 – not included
- Built-in fan
- Input voltage: 115/230VAC @ 50-60Hz (auto switching)



Special Purchase
LOW LOW PRICE

Part No.	Product No.	Description	1	10	25
196189CD	MPW-6150F	150W ..	\$34.95	\$31.49	\$27.95



AT 200-Watt

- Output:
 - +5V @ 20A
 - +12V @ 8A
 - 5V @ 0.5A
 - 12V @ 0.5A
- Input voltage: 115/230VAC @ 50-60Hz (switchable)
- AT compatible connectors
- Mating input connector: 3-prong AC receptacle with 6' power cord
- Built-in fan



Includes: 6' power cord

Part No.	Product No.	Description	1	10	25
172822CD	AA-230	200W	\$44.95	\$39.95	\$35.95

ATX 250-Watt + 250-Watt

Redundant

SALE

- Output:
 - +3.3V @ 15A
 - +5VSB @ 1.5A
 - +5V @ 30A
 - +12V @ 14A
 - 5V @ 0.5A -12V @ 1A
- Hot swappable; power fail alarm
- Input volt.: 90-264VAC @ 47-63Hz (auto ranging)
- Built-in fan
- 20-pin ATX form factor
- Internal OR-ing diode for redundant operation



Part No.	Product No.	1	10	25
201443CD	EPR2251	\$136.85	\$124.39	\$113.49

SALE

145 to 400-Watt PC Power Supplies



Part Number	Mfr.	Product Number	Power (W)	Output (VDC/A)	Input (VAC @ Hz)	Input Connector (Mating Connector/Cord)	Output Conn. (Mating Conn.)	Certification	Size (L" x W" x H")	Wt. (lbs.)	Pricing		
											1	10	25
201435CD	Xtreme Power	EPA400	400	+3.3/33, +5/45, +12/15, +5VSB/1, -5/1, -12/1	115/230 @ 47-63 switchable	3-prong AC receptacle with 6' power cord	ATX	UL/CSA/TUV/CE	5.6 x 5.9 x 3.4	5.0	\$109.99	\$93.49	\$70.15
155539CD	American Media	JE2033	300	+3.3/14, +5/30, +12/8, +5VSB/1.5, -5/0.5, -12/0.5	115/230 @ 50-60 switchable	3-prong AC receptacle with 6' power cord	ATX	UL/CSA/TUV	5.9 x 5.5 x 3.4	3.7	69.95	62.95	56.95
155811CD	—	JE5300	300	+3.3/14, +5/25, +12/12, +5VSB/0.8, -5/0.5, -12/0.5	115/230 @ 50-60 switchable	3-prong AC receptacle with 6' power cord	ATX	UL/CSA/TUV	5.9 x 5.5 x 3.2	4.1	79.95	71.95	64.95
205938CD	TGR	FA250N16	250	+3.3/14, +5/25, +12/10, +5VSB/3, -5/0.5, -12/1	115/230 @ 50-60 switchable	3-prong AC receptacle (P/N 38050CD, pg 49)	ATX	UL/CUL/TUV/CE	5.5 x 6.0 x 3.5	3.5	27.95	25.95	23.45
201427CD	Xtreme Power	EPA250	250	+3.3/16, +5/25, +12/10, +5VSB/2, -5/1, -12/1	115/230 @ 47-63 switchable	3-prong AC receptacle with 6' power cord	ATX	UL/CSA/TUV/CE	5.5 x 5.4 x 3.4	5.0	31.49	28.39	25.49
152194CD	American Media	JE2031	250	+3.3/14, +5/25, +12/10, +5VSB/1.5, -5/0.5, -12/0.5	115/230 @ 50-60 switchable	3-prong AC receptacle with 6' power cord	ATX	UL/CSA/TUV	6.0 x 5.5 x 3.4	3.5	49.95	44.99	40.49
152514CD	High Power	JE8250	250	+3.3/16, +5/25, +12/10, +5VSB/1.5, -5/0.5, -12/0.5	115/230 @ 50-60 switchable	3-prong AC receptacle with 6' power cord	ATX	UL/CSA/TUV	5.5 x 5.9 x 3.4	3.3	44.95	39.95	36.39
196437CD	Hipro	HP235NLXAK	235	+3.3/14, +5/25, +12/8, +5VSB/0.1, -5/0.5, -12/0.5	115/230 @ 50-60 switchable	3-prong AC receptacle (P/N 38050CD, pg 49)	ATX	UL/CSA/TUV/CE	5.5 x 5.9 x 3.2	3.2	24.99	21.25	15.35
196111CD	SPI	FSP23560GT	235	+3.3/14, +5/22, +12/8, +5VSB/0.8, -5/0.3, -12/0.8	100/240 @ 50-60 switchable	3-prong AC receptacle (P/N 38050CD, pg 49)	ATX	UL/CUL/TUV/CE	5.6 x 5.9 x 3.4	3.2	34.95	26.25	18.35
202788CD	Enhance	SFX2015	150	+3.3/7, +5/12, +12/5, +5VSB/0.8, -5/0.2, -12/0.3	115/240 @ 47-63 switchable	3-prong AC receptacle (P/N 38050CD, pg 49)	ATX	UL/CUL/TUV/CE	5.9 x 3.6 x 3.4	2.1	34.95	29.49	22.29
196189CD	Emaos	MPW-6150F*	150	+3.3/6, +5/10, +12/6, +5VSB/0.72, -5/0.2, -12/1	115/230 @ 50-60 switchable	3-prong AC receptacle (P/N 38050CD, pg 49)	ATX	UL/CUL/TUV/CE	7.5 x 4.0 x 1.6	2.5	34.95	31.49	27.95
177535CD	Trimag	BM5200	200	+5/19.8, +12/7.3, +5VSB/0.8, -5/0.2, -12/0.3	115/240 @ 47-63 switchable	3-prong AC receptacle with 6' power cord	XT/AT	UL	8.7 x 5.6 x 4.7	5.5	39.95	35.99	27.99
205639CD	Sunpower	SQ-3005	300	+5/30, +12/12, -5/0.5, -12/0.5	115/230 @ 50-60 auto switching	3-prong AC receptacle with 6' power cord	IBM AT	UL/CSA/VE	5.6 x 5.9 x 3.4	4.1	59.95	53.95	48.95
132185CD	APS	JE1035	300	+3.3/28, +5/30, +12/10, -5/1, -12/1	110/220 @ 50-60 switchable	3-prong AC receptacle with 6' power cord	IBM AT	UL/CSA/TUV	5.5 x 5.9 x 3.4	4.7	109.95	99.95	89.95
196728CD	L & C	LC300ATX	300	+3.3/14, +5/25, +12/10, +5VSB/1, -5/0.5, -12/0.5	115/230 @ 50-60 switchable	3-prong AC receptacle (P/N 38050CD, pg 49)	IBM AT	UL/CSA/TUV/CE	6.0 x 5.5 x 3.4	2.5	25.75	23.19	20.85
190123CD	Golden Systems	GPC200-5000	200	+3.3/20, +5/20, +12/8, -5/0.5, -12/0.5	115-230 @ 50-60 switchable	3-prong AC receptacle (P/N 38050CD, pg 49)	IBM AT	UL/CUL/TUV	5.5 x 5.9 x 3.7	4.2	9.95	8.95	7.95
190094CD	Delta	DPS200PB	200	+3.3/20, +5/20, +12/8, -5/0.5, -12/0.5	100-240 @ 50-60	3-prong AC receptacle (P/N 38050CD, pg 49)	IBM AT	UL/CSA/TUV	5.5 x 5.9 x 3.4	3.2	19.99	16.99	12.75
189704CD	Astec	SA1453490	145	+5/18, +12/6, -5/0.3, -12/0.8	100-240 @ 50-60	3-prong AC receptacle (P/N 38050CD, pg 49)	IBM AT	UL/CSA/VE/CE	5.9 x 5.5 x 3.4	2.3	29.95	26.95	23.95
201443CD	Etasis	EPR2251*	250/250 Dual	+3.3/15, +5/30, +12/14, +5VSB/1.5, -5/0.5, -12/1	90-264 @ 47-63 auto ranging	3-prong AC receptacle with 6' power cord	AT	UL/CUL/TUV/CE	7.0 x 3.4 x 9.0	2.6	136.85	124.39	113.49
174465CD	Logic Concept	LC250C	250	+5/20, +12/10, -5/0.5, -12/0.5	110/220 @ 50-67 switchable	3-prong AC receptacle with 6' power cord	AT	UL/CSA/TUV/CE	5.5 x 5.9 x 3.4	2.0	49.95	44.95	39.95
200694CD	Compaq	DPS-200PB-38	200	+5/22, +12/7, -5/0.15, -12/0.15	110/230 @ 50-60 switchable	3-prong AC receptacle (P/N 38050CD, pg 49)	AT	UL/CSA/TUV	5.5 x 5.9 x 3.5	2.8	19.95	17.59	15.95
172822CD	Mean Well	AA-230*	200	+5/20, +12/8, -5/0.5, -12/0.5	115/230 @ 50-60 switchable	3-prong AC receptacle with 6' power cord	AT	CSA/TUV/CE	6.0 x 4.6 x 3.4	2.6	44.95	39.95	35.95
190115CD	API	API-3186S	200	+3.3/20, +5/20, +12/8, -5/0.5, -12/0.5	115/230 @ 50-60 switchable	3-prong AC receptacle (P/N 38050CD, pg 49)	STD AT	UL/CSA/TUV	5.5 x 5.9 x 3.7	3.5	9.59	8.69	7.79

* See photo above

Opening an account is easy! Call 1-800-831-4242 for details today.

Corporate Customers

SALE

Pentium® II Class Motherboards

ATX Motherboards are compatible with Intel Pentium® II processors.



188082CD 188091CD 185367CD 188074CD 185359CD 185682CD 185674CD 185666CD

Part No.	188082CD	188091CD	185367CD	188074CD	185359CD	185682CD	185674CD	185666CD	
Processor	Slot 1 *	Slot 1 *	Slot 1	Slot 1 *	Slot 1	Socket 370	Dual Slot 1	Dual Slot 1	
Speed	233-333 MHz	233-333 MHz	233-333 MHz	233-266 MHz	233-333 MHz	366-533MHz	233-333MHz	233-333MHz	
Chip set	440LX	440LX	440LX	440LX	440EX	i810M	440LX	440LX	
BIOS	Award	Award	Award	Award	Award	AMI	Award	Award	
Memory	SIMM (72-pin)	EDO (168-pin)	EDO (168-pin)	EDO (72-pin)	SDRAM (168-pin)	SDRAM (168-pin)	EDO (168-pin)	SDRAM (168-pin)	
Capacity	384MB	768MB	384MB	384MB	256MB	512MB	1,024MB	512MB	
Slots	6	3	3	6	2	2	4	4	
Speed	66 MHz	66 MHz	66 MHz	66 MHz	66 MHz	66/100MHz	66MHz	66MHz	
Slots									
PCI	5	4	4	5	2	3	5	5	
AGP	None	1	1	1	1	Integrated	1	1	
ISA	3	3	3	3	2	None	2	2	
Interfaces									
Hard Drive	4 EIDE	4 EIDE	4 EIDE	4 EIDE	4 EIDE	4 ATA-66	2 IDE, SCSI	4 EIDE	
Floppy	2	2	2	2	2	2	2	2	
USB	2	2	2	2	2	2	2	2	
Parallel	1	1	1	1	1	1	1	1	
Serial	2	2	2	2	2	2	2	2	
IrDA	None	None	None	1	None	None	None	None	
Sound	CS4237B	None	None	None	ESS	ES1373	None	None	
Keyboard	PS/2	PS/2	PS/2	PS/2	PS/2	PS/2	PS/2	PS/2	
Video	None	None	None	None	None	4MB	None	None	
Size	12" x 9.6"	12" x 7.5"	12" x 7.4"	12" x 9.6"	9" x 7.8"	9.6" x 7.5"	12" x 9.6"	12" x 9.6"	
Weight	2.6 lbs.	2.5 lbs.	2.5 lbs.	2.6 lbs.	1.9 lbs.	1.5 lbs.	3.0 lbs.	3.0 lbs.	
Price	1	\$16.65	\$30.15	\$27.29	\$12.49	\$24.95	\$44.45	\$36.65	\$31.95
	10	\$15.15	\$27.45	\$24.49	\$11.25	\$22.45	\$40.39	\$33.29	\$28.75

* Also supports the Intel Celeron™ processor

Socket 370: Intel Celeron™ PPGA Package processor (see page 0) Slot 1: Intel Pentium® II processor (see page 69)

DIMM and SIMM Memory



148398CD

148443CD

Part Number	Mfr. Cross Ref. No.	Pins	Description	1	10
148398CD	4MBX64SDRAM	168	4M x 64 10ns Syn. DRAM DIMM (32MB)	\$16.95	\$15.95
148401CD	8MBX64SDRAM	168	8M x 64 10ns Syn. DRAM DIMM (64MB) ..	35.95	32.29
148419CD	16MBX64SDRAM	168	16M x 64 10ns Syn. DRAM DIMM (128MB)	69.95	62.99
130729CD	JEEDO7208	72	2M x 32 60ns SIMM EDO module (8MB) ..	11.95	9.95
130711CD	JEEDO7216	72	4M x 32 60ns SIMM EDO module (16MB) ..	24.95	22.95
148443CD	JEEDO7232	72	8M x 32 60ns SIMM EDO module (32MB)	43.95	39.59
148451CD	JEEDO7264	72	16M x 32 60ns SIMM EDO module (64MB)	29.95	28.45
75133CD	P361000-XX-6	72	1M x 36 60ns SIMM module (4MB)	12.95	11.65
75096CD	P362000-XX-6	72	2M x 36 60ns SIMM module (8MB)	28.49	25.95
75184CD	P364000-XX-6	72	4M x 36 60ns SIMM module (16MB)	47.95	43.15
75168CD	P364000-XX-7	72	4M x 36 70ns SIMM module (16MB)	45.95	41.49
148460CD	8MBX36-60	72	8M x 36 60ns SIMM module (32MB)	87.95	79.19
41751CD	421000A9B-70	30	1M x 9 70ns SIMM module (3 chips)	3.95	3.45
53701CD	94000S-70	30	4M x 9 70ns SIMM module (9 chips)	10.15	9.15

Celeron 400-700MHz and Pentium III 533-1000MHz

Intel 815E (Solano 2) Chipset

- Phoenix BIOS
- Windows Plug and Play compatible
- Slot 370 type for Celeron 400MHz-700MHz or Pentium® III 533MHz to 1000MHz
- Supports three 168-pin SDRAM PC100/PC133 memory upgradeable to 512MB
- 6 PCI slots and 1 AGP slot
- On-board I/O controller: 2 EIDE ports that support 4 EIDE devices, floppy drive port that supports LS-120 drive; IRDA port
- PS/2 female keyboard and mouse; 2 USB ports; DB9 male and female serial ports; DB25 female parallel port; DB15 female game port; 3 audio I/O jacks (modular connectors)
- 20-pin ATX form factor
- Size: 12.0"L x 8.8"W
- Weight: 3 lbs.



Includes: Manual and drivers on CD-ROM

Part No.	Mfr. Cross Ref. No.	Description	1	10
218835CD	SY-715A	Celeron and Pentium® III motherboard	\$64.95	\$59.95

In-Ear Stereo Headphones

- 3.5mm input jack connector
- Typical application: CD player
- Color: gray
- 4' Long

SALE



Part No.	Description	1	10	100	1000
191880CD	Headphones	\$0.39	\$0.36	\$0.32	\$0.29

See the yellow and green highlighted items. Sale details are on page 4.

Jameco Special Values!

Back Panel PC Cooling Fan

- Type: sleeve axial fan
- Back panel mountable
- Operating volt.: 12VDC @ 140mA
- Airflow: 43 CFM
- Noise ratio: 26dBA
- Power: 1.7W
- 10.5" wire with 4-pin Molex power connector
- Size: 4.3"L x 3.5"H x 1.1"Thick • One-year warranty



Part No.	Description	1	10	50
152240CD	PC cooler fan	\$19.95	\$17.95	\$15.95

Thermoelectric Cooler Chips

- Cools down to -30°C (dependent on external temp.)
- T max. = 60°C
- 20 AWG wire leads, 4" long
- Heat or cool by changing direction of current



- 172030CD: 8.4VDC max.**
- Couples: 71* • Watts: 19.7
 - Current: 4A max. • Size: 1.2"L x 1.2"W x 0.2"
- 172048CD: 15.4VDC max.**
- Couples: 127* • Watts: 35.6
 - Current: 4A max. • Size: 1.6"L x 1.6"W x 0.2"
- 172056CD: 15.4VDC max.**
- Couples: 127* • Watts: 79.1
 - Current: 8A max. • Size: 2.0"L x 2.0"W x 0.2"

Part No.	Mfr. Cross Ref. No.	1	10
172030CD	TEC30	\$19.95	\$17.95
172048CD	TEC40	\$25.95	\$22.95
172056CD	TEC50	\$41.99	\$33.59

* Couples: # of P&N type semiconductor pairs connected electrically in series

Order Anytime 24x7x365

Phone 1-800-831-4242 Fax 1-800-237-6948
Online www.Jameco.com

See page 77 for Heat Sink Compound

CPU Heat Sinks and Fans

See page 69 for CPUs



- Excellent for avoiding CPU overheating during extended system on-time
- High efficiency cooling fans • Easy installation – just snap it in

Part No.	Description	Size (H" x W" x D")	Agency Approvals	1	10	50	100
211211CD	Heat sink w/ fan slot (SEEC 1)	2.05 x 4.92 x 1.17	UL/CSA/TUV/CE	\$9.95	\$8.95	\$7.95	\$6.95
206244CD	Heat sink w/ dual fan slot (SECC 2)	5.25 x 1.95 x 1.30	CE	12.95	11.65	10.49	9.49
196242CD	Heat sink w/ fan for socket 7 (ATX)	2.26 x 2.12 x 1.07	UL/CE/TUV	9.95	8.95	7.95	6.95
181278CD	Heat sink w/ fan for socket 7 (ATX)	2.12 x 2.05 x 1.67	UL/CE/CSA	8.49	7.65	6.89	6.19
216506CD	Heat sink w/ fan for socket 7 (AT/ATX)	1.95 x 2.05 x 1.37	CE	9.95	8.95	7.95	7.95
207044CD	Heat sink w/ fan for socket 370 (ATX)	2.48 x 2.00 x 1.32	UL/CUL/CE/TUV	14.95	13.49	11.95	10.75
190545CD	Heat sink w/ fan for socket 370	2.45 x 2.42 x 2.10	—	14.99	13.99	12.99	11.99
203115CD	Heat sink for Pentium® Pro– adhesive back	2.18 x 1.95 x 0.76	UL/CSA/TUV/CE	1.65	1.49	1.35	1.25
203123CD	Heat sink for Pentium® Pro– adhesive back	2.34 x 2.10 x 1.77	UL/CSA/TUV/CE	1.85	1.69	1.55	1.39
185607CD	Heat sink w/ fan for Pentium® Pro	2.75 x 2.84 x 1.75	UL/CE/TUV	14.95	13.49	11.95	10.75
118092CD	Heat sink w/ fan for 586 CPU w/ snap	2.18 x 2.30 x 0.86	UL/CE/TUV	4.95	4.49	3.59	2.69
129226CD	Heat sink for 486 CPU – adhesive back	1.70 x 1.63 x 0.36	—	2.95	2.65	2.39	2.15
129234CD	Heat sink for 486 CPU – adhesive back	1.70 x 1.64 x 0.66	—	3.95	3.55	3.19	2.79
191636CD	Heat sink w/ fan for 486 CPU w/ clip	1.85 x 1.92 x 0.72	UL/CE/TUV	5.95	5.39	4.29	4.29
174115CD	Heat sink w/ fan for 486 CPU w/ snap*	1.93 x 1.96 x 0.93	UL/CUL	3.95	3.55	2.95	2.65

* 14" lead wires

State-of-the-Art Audio Products



"The World Standard In Professional Audio"

Noise Canceling Headphones

Eliminate "acoustic junk" noise from cars and machines that cause stress and lead to anxiety and problems with concentration. The NoiseGard system filters out that fatiguing, annoying noise and really lets you enjoy your favorite music. These incredible headphones work on a simple physical principle: sound is cancelled out by anti-static sound, which is phase-shifted through 180°. Lovers of classical music will be treated to detailed sound reproduction and clear separation of instruments. Those into pop music can enjoy a rich powerful bass response.



Folded in case

- Fold and flip – design allows the ear cups to be turned through 90° and fold the headphone closed
- 1.8m Kevlar-reinforced OFC copper cable w/ 3.5mm jack
- Dynamic, closed transducer principle
- 10Hz to 21,000Hz frequency response
- Supplied with soft belt pouch with extra pocket
- 300Ω impedance
- 106dB sound pressure level

Part No.	Description	Price
227088CD	Foldable noise canceling headphone	\$149.95



Cellphone Headset

The MAB-18 is the first in-ear system headset for mobile telephones. It offers a flexible microphone arm, cable clip and the possibility of left or right wearing style. It comes with a 2.5mm jack plug that is compatible with most mobile phones.



- 20Hz to 22,000Hz freq. response (headphones); 40-15,000Hz (microphone)
- Omni-directional microphone
- 32W impedance (headphone), 1.4kW impedance (microphone)
- 106dB sound pressure level

Part No.	Description	Price
227096CD	Cell phone headset	\$21.95

U.S. Robotics® Wireless Audio Broadcast System

Why limit your music's reach when you can listen to your favorite tunes anywhere. Release your MP3s and Internet radio from the confines of your computer and listen to them in HI-FI on stereo from the living room. Simply plug the transmitter into a music source (PC/MP3 player, CD/DVD, etc.) and either plug the receiver unit into your stereo's audio input or simply set your FM tuner to 88.1 or 88.3 station.



Best Seller

- Listen and enjoy internet radio/audio on your home stereo or any FM receiver
- Freedom to rebroadcast music where you are
- Transmits on 900MHz frequency up to 1000'
- Compatible with any audio device's 3.5mm or RCA output jack
- Size: (transmitter) 3.8"H x 4.9"W x 4.0"D; (receiver) 3.7"H x 4.9"W x 3.7"D • Weight: 2.2 lbs.

Includes: Two 6VDC @ 100mA power supply, 3.5mm stereo cable, 3.5mm to RCA cable, RCA cable

Part No.	Description	1	5
210981CD	Wireless audio system	\$74.95	\$67.45



ATX Power Supply 15" Extension Cable

- For use with ATX power supplies
- 20-pin ATX male and female connectors
- Color coded to ATX power supply code
- 15"L x 18 AWG (wires)



Part No.	Mfr. Cross Ref. No.	1	10	100
170237CD	ATX-400-RV	\$6.49	\$5.85	\$5.29

3.5" Disk Drive Power Adapter Cable

- IBM PC/XT and higher compatibles
- Allows connection of standard 3.5" disk drives to power supplies

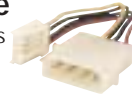

Part No.	Length	AWG	1	10	100
28396CD	3.5"	22	\$2.49	\$2.25	\$1.95

3.5" & 5.25" Disk Drive Power Splitters

- IBM PC/XT and higher compatibles
- Splits 4-line Molex male into 2 females

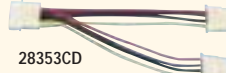

Part No.	Drive	AWG	Length	1	10	100
28353CD	5.25"	18	5"	\$2.95	\$2.69	\$2.15
72303CD	3.5"	22	5"	2.75	2.49	2.19

CD-ROM Audio Cables



- 2 x 28
- 127546CD: Compatible w/ most CD-ROMs
- 168612CD: • 3 connectors on each end of wire:
 - 4-position (.100") housing connector;
 - 4-position (.100") Molex-type keyed connector;
 - 3-position (.100") Molex-type keyed connector
- Use with Creative Labs, Sony or generic sound cards

Part No.	Connection from Sound Blaster to	Length	1	10	50
127546CD	Sony/MPC2	25"	\$2.95	\$2.65	\$2.29
168612CD	Universal	18"	4.95	3.99	3.29

Internal Computer Ribbon Cables

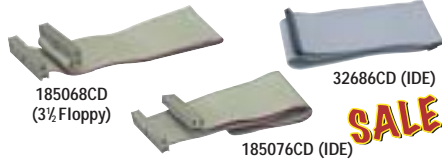

Part No.	Conductors	Length	1	10	100
185068CD	34	9.0"	\$2.95	\$2.55	\$1.89
185076CD	40	14.0"	.79	.69	.59
32686CD	40	18.0"	3.95	3.49	2.95

Ribbon Cable Assemblies

- Metal connector
- 300V rating • 105°C rating
- 28 AWG flat cable
- Tin-plated contacts

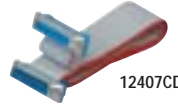

Part No.	Description	1	10	100
12407CD	4' DB25 M-F	\$4.49	\$3.95	\$3.59
208581CD	6' DB9 M-F	3.95	3.55	3.19
208590CD	6' DB25 M-M	4.49	3.95	3.65
208602CD	6' DB25 F-F	4.49	3.95	3.65

Computer Card Brackets



- For securing cards into bus slots
- Fits standard PC/XT/AT cases • Length: 4.75"
- See pg 125 for DB connectors

Part No.	Description	Fig.	1	10	100
11754CD	Blank back panel	1	\$1.79	\$1.59	\$1.45
101717CD	For DB9 connector	2	1.79	1.59	1.45
101733CD	For DB25 connector	3	1.79	1.59	1.45
101741CD	For DC37 connector	4	1.79	1.59	1.45
101830CD	For DB9/DB25 conn.	5	1.79	1.59	1.45

Panel Bracket Cable Assemblies

- Standard computer back panel brackets
- Length: 12"
- Ribbon cable with header connector



149614CD: 2 serial ports
149622CD: 1 parallel port
179995CD: 1 parallel & 2 serial ports

Part No.	Description	1	10	25
149614CD	DB9M to 10-pin header			
	DB25M to 10-pin header	\$4.95	\$4.49	\$3.49
149622CD	DB25 to 26-pin header	4.95	4.49	3.59
179995CD	DB9M to 10-pin header			
	DB25M to 10-pin header			
	DB25F to 26-pin header	1.19	1.09	.99

Controller Cards Page 179

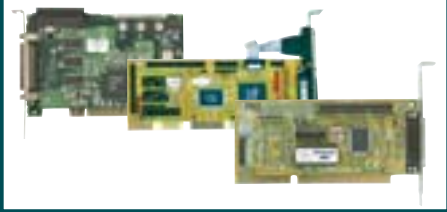

Disk Drive Cables

Part No.	Description	Cable Length	1	10	100
185084CD	34-pin header socket ribbon cable for floppy drive	25"	\$1.19	\$1.05	\$0.76
32918CD	34-pin header socket ribbon cable for floppy to card	23"	3.49	2.99	2.25
72805CD	Two 40-pin header socket ribbon cable for IDE drive	18"	3.69	3.09	2.19
179987CD	One 40-pin and one 34-pin cable kit	20"/25"	.55	.49	.45
175492CD	40-pin header socket ribbon cable for ultra DMA66/100	17"	6.95	6.25	5.49

Internal and External SCSI Cables for Complete Connectivity

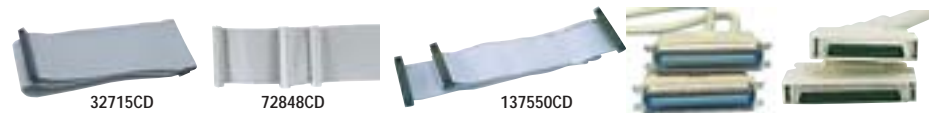

- For PC/XT/AT and compatibles
- All lines connected

Part No.	Description	1	10	100
32715CD	50-pin header socket ribbon cable SCSI-I (18")	\$3.95	\$3.49	\$2.95
72848CD	50-pin header socket ribbon cable SCSI-I (24")†	3.49	2.95	2.49
137550CD	68-pin header internal ribbon cable SCSI-III (27")	17.95	15.95	14.49
189641CD	68-pin header internal ribbon cable with term SCSI-III (42")	6.15	5.59	5.19
180507CD	Male 50-pin Centronics to male DB25 (SCSI-I) 5.5'	3.49	3.15	2.79
164769CD	Male 50-pin Centronics to male 50-pin Centronics SCSI-I to SCSI-I (3")†	2.15	1.95	1.75
73162CD	Male 50-pin Centronics to male 50-pin Centronics SCSI-I to SCSI-I (6")†	6.95	5.95	4.45
118084CD	Male 50-pin Centronics to male HPDB50 cable SCSI-I to SCSI-II (6')	14.95	13.49	11.95
118914CD	Male HPDB50 to male HPDB50 SCSI-II to SCSI-II (3')	14.95	13.49	11.95
118076CD	Male HPDB50 to male HPDB50 SCSI-II to SCSI-II (6')	17.95	15.95	13.95
137576CD	Male HPDB68-pin to male 50-pin Centronics SCSI-III to SCSI-I (3')	18.49	16.65	14.95
137568CD	Male HPDB68-pin to male HPDB50-pin SCSI-III to SCSI-II (3')	12.95	11.49	9.95

† Also Macintosh® compatibles, see right for SCSI type connector guide

SCSI Adapters



- See below for SCSI-type connector guide

Part No.	Description	1	10	50
133920CD	50-pin ribbon header			
	SCSI-I to DB25 female	\$8.95	\$7.95	\$7.25
125241CD	50-pin ribbon header to HPDB50 SCSI-II female	9.95	8.95	7.95
167370CD	DB25 female to HPDB50 male SCSI-II	9.95	8.49	6.35

SCSI TYPE / CONNECTOR REFERENCE TABLE

SCSI type	50-pin Centronics DB25	50-pin Header	Half pitch DB50	Half pitch DB68	HPDB50 Centronics	HPDB50 Centronics
SCSI-I	✓	✓				
SCSI-II			✓	✓		
SCSI-II wide					✓	
SCSI-III						✓
RAID: SCA, SCA-2						✓

1.44MB 3.5" Internal Floppy Disk Drives

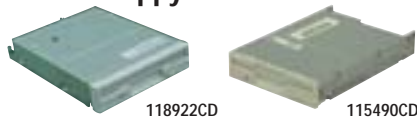

- IBM PC/XT and higher compatibles
- Compatible with DOS versions 3.3 or higher
- Automatically determines if disk is high or low density
- Size: 4.0"W x 5.9"D x 1.0"H (actual drive size)
- Weight: 1.4 lbs.

SALE

Part No.	Mfr. Cross Ref. No.	Mfr.	Color	1	10
224346CD	JU256A216P*	Panasonic	Gray	\$16.95	\$15.25
118922CD	MPF520-1	Sony	Beige	29.95	26.95
115490CD	FD235	TEAC	Beige	21.95	19.95
189165CD	—	Varies	Beige	9.95	8.95
189350CD	—	Varies	Black	6.75	6.15
224012CD	FD235HF	Varies	Black	12.95	11.65
200686CD	—	Varies	(No Bezel)	6.95	5.95

3.5" Drive Mounting Kit

- For mounting a 3.5" floppy drive into a 5.25" slot



Includes: Beige faceplate

Part No.	Description	1	10	50
32088CD	Drive mounting kit ...	\$7.69	\$6.95	\$6.25

SONY® Triple Density 3.5" Internal Floppy Disk Drive

Without Bezel

- Supports 1MB, 1.6MB and 2MB unformatted capacities
- Size: 4.0"W x 5.9"D x 1.0"H
- Weight: 0.8 lbs.

SALE



Part No.	Product No.	Manufacturer	1	10
176284CD	MPF520-7	Sony	\$5.99	\$5.49

Panasonic® Floppy Disk Drive

- 1.44MB capacity
- Compatible with late model Quadras, all Power PCs and G3s
- Size: 5.7"L x 4.0"W x 1.0"H



SALE

Part No.	Description	Wt. (lbs.)	1	10	25
154608CD	Manual insert	1.2	\$19.55	\$17.79	\$16.19

5.25" Hard Drive Cooling Assembly

Dual Fans for Even Cooling
Keep your hard drive cool by using less space. These hard drive cooling fans have 2 high-airflow fans that provide 70% heat dissipation.



SALE

- RPM per fan: 3800
- Combined airflow: 28 CFM
- Dual 12V sleeve bearing fan
- Power consumption: 1.44W each
- Easy installation
- Size: 5.7"L x 5.5"W x 1.2"H

Includes: Mounting hardware

Part No.	Description	1	10	25
175302CD	HD cooler (5.25")	\$9.95	\$9.59	\$9.19

IDE, EIDE & SCSI Hard Drives and Mounting Kits

PC/XT/AT and Compatibles

- IDE drives over 528MB require EIDE controller or higher
- Manufacturers may vary and capacity may exceed specification; we carry Seagate, Western Digital, IBM and others.
- All are 1" in height, except as noted



Part No.	Capacity	Description	Conn. Pins	Wt. (lbs.)	Average Access Time (ms)	Warranty	1	10
200803CD	17.2GB	3.5" IDE	40	1.1	9.5	3 mos. ...	\$99.95	\$94.95
200678CD	15.0GB	3.5" IDE	40	1.1	9.5	3 mos. ...	114.95	99.95
200660CD	13.0GB	3.5" IDE (ATA-4)	40	1.1	9.5	3 mos. ...	144.95	129.95
200651CD	10.2GB	3.5" IDE	40	1.1	9.5	3 mos. ...	139.95	125.95
162261CD	8.45GB	3.5" EIDE (Ultra DMA33)	40	1.2	9.5	1 year	139.95	125.95
151052CD	6.4GB	3.5" EIDE (Ultra DMA33)	40	1.1	9.5	1 year	129.95	116.95
151044CD	4.3GB	3.5" EIDE (Ultra DMA33)	40	1.1	11.5	1 year	119.95	109.95
151036CD	3.2GB	3.5" EIDE (Ultra DMA33)	40	1.1	11	1 year	114.95	105.95
146333CD	2.5GB	3.5" EIDE (Fast ATA-2)	40	1.0	11	1 year	99.95	79.99
146325CD	1.7GB	3.5" IDE (Fast ATA-2)	40	1.1	12	1 year	99.95	89.95
124978CD	1.27GB	3.5" IDE	40	1.1	14	1 year	79.95	71.95
118949CD	850MB	3.5" IDE	40	1.7	14	1 year	84.95	75.95
115764CD	425MB	3.5" IDE	40	1.7	12.5	3 mos. ...	79.95	71.95
189914CD	9.1GB	SCSI (wide, ultra, SCA)	80	1.4	5.0	3 mos. ...	102.55	92.29
188907CD	4.0GB	SCSI (wide, ultra, SCA)	80	1.2	8.1	3 mos. ...	64.95	58.39
199494CD	2.0GB	SCSI (wide, fast) (1.5")	68	1.2	8.0	3 mos. ...	15.99	14.55
197579CD	4.0GB	SCSI (Fast SCSI-II) (1.5")	50	1.3	8.0	3 mos. ...	69.95	62.99
189085CD	1.0GB	SCSI	50	1.3	9.6	3 mos. ...	39.95	35.95

Part No.	Mfr. Cross Ref. No.	Description	Wt. (lbs.)	1	10	25
180857CD	HDB35	3.5" hard drive mount kit (short)	0.2	\$4.95	\$3.75	\$2.65
117217CD	HDMK	3.5" kit (w/ black & gray faceplates)	0.6	7.95	7.25	6.49
34323CD	LIMR	AT mounting rails (2)	0.1	.27	.25	.23

Aluminum IDE Removable Hard Drive Rack with Fan

Easily remove a hard drive from your PC or workstation, safeguard your data and an ideal way to back-up data. Because rack kit is hot removable, you can remove your hard drive without shutting down your computer operations. Aluminum case transfers heat away from the drive for longer & more reliable drive life.



- 5.25" rack kit for 3.5" hard drives
- Drive activity LED
- Built-in fan
- Aluminum rack
- Keylock for security

Part No.	Description	1	10	25
211035CD	Rack kit (IDE)	\$29.95	\$26.95	\$23.95

Internal IDE CD-ROM Drives

- 5.25" half-height design
- One-year warranty
- Manufacturer varies



Part No.	Speed	Buffer	kB/sec.	Wt. (lbs.)	1	10
181745CD	24x	128kB	3600	2.3	\$29.95	\$26.99
149307CD	24x	256kB	3600	2.6	34.95	32.95
189051CD	32x	128kB	4800	2.6	34.95	31.49
189069CD	40x	128kB	6000	2.6	39.95	35.95
189819CD	40x	128kB	6000	2.6	34.95	31.25
162042CD	44x	128kB	6600	2.5	44.95	35.99
189077CD	48x	128kB	7200	2.6	49.95	44.95
189448CD	56x	128kB	8400	2.3	59.95	53.95

† Slot type

CD Accessories



Part No.	Description	1	10	100
172179CD	Single jewel case	\$0.40	\$0.36	\$0.31
208514CD	Paper envelope 25 pk.	2.49	2.19	1.99
208506CD	Clamshell case 10 pk.	2.75	2.49	2.25
208485CD	Slim black 10 pk.	3.59	3.19	2.89
208493CD	Slim asst. color 10 pk.	4.95	4.45	3.95
76591CD	Caddy	3.89	3.55	3.25

External CD-ROM Case

- SCSI-I interface
- SCSI-ID address selector
- Streamlined appearance
- RCA jack
- Metal body with plastic front panel
- 50-watt universal switching power supply
- Size: 6.5"W x 11.8"D x 2.0"H
- Weight: 3.8 lbs.
- Use cable (P/N 73162CD, pg 172) for connections



Part No.	Description	1	10
126391CD	SCSI CD-ROM ext. case	\$49.95	\$44.95

We'll Send It Today!

Don't worry about backorders.
Over 99% of our products are in stock!

Fellowes Premium Confetti-Cut Personal Shredder



Shredded pieces (Confetti-cut)

When it's time to discard sensitive memos, bank statements, accounting records or other confidential business materials, you want to rest assured that they're gone for good. The PS60C-2 features faster throughput, greater capacity and a finer cut so your documents will disappear in short order. Do not let prying eyes poach business records. Let this model's confetti-cutting power turn that stack of confidential paperwork into a handful of scrambled dregs with shredded ease.

Part No.	Description	Price
219176CD	Confetti-cut shredder (refurbished)	\$49.95

Fellowes Personal Strip-Cut Shredder

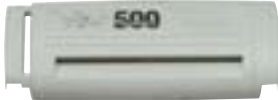

Shredded pieces (Strip-cut)

Protect yourself from prying eyes and "dumpster divers" with a personal shredder that's packed with features. The P500-2 is automatic to go anywhere you need it. Auto-start and stop means you can feed in up to 7 sheets at a time (staples, paper clips and all!) with one-handed ease; no fumbling for a switch. And at this price, you can turn every wastebasket in your home or office into a maximum security receptacle.

Part No.	Description	Price
219184CD	Personal strip-cut shredder	\$9.95

OfficeJet Four-In-One – The Small Office Solution!

Save time and space in your home office or cubicle. This HP multifunctional unit allows you to print, fax, scan and copy for less than many single function units. Professional quality color or black and white printer is at your command in your format of choice: letter, legal, executive, #10 envelope, card stock, or transparency film. Clear and fast faxes with transmission speed of 6 seconds per page at 300dpi grayscale, and 150 pages of memory. Full featured copier with 50% to 200% reduction or enlargement, and makes up to 99 copies at once. Sheet-fed color scanner saves you time with clear, crisp 24-bit color or 8-bit grayscale scans.



- Color copy @ 3.5 minutes per page, or black and white @ 1 minute per page
- Prints black and white @ 3.5ppm and color @ 1ppm
- 150 sheet tray capacity
- ITU group fax 3 compatible
- Scanner supports 300dpi to 1200dpi enhancement
- Size: 17.0"W x 14.2"D x 10.2"H (with tray installed)
- Parallel port interface
- 100 speed dial memory
- Modem speed of 300bps to 14,400bps
- Weight: 15 lbs.

Includes: CD-ROM manual and drivers

Part No.	Description	Price
211043CD	HP OfficeJet 600 four-in-one unit	\$129.95
182967CD	Black ink cartridge.....	35.95
182975CD	Color ink cartridge.....	36.95



SALE

CDPrint Printer

Delivers a low-cost way to create professionally printed CD-R's, Credit Card CD-R's, CD Jewel case liner notes and standard color paper documents. Don't settle for unsightly felt pen scribbles or hard-to-use labels on your CD's. Now print full color images, photos, and text directly on your CD in less than a minute. EZ/CDPRINT is ideal for amateur musicians, family photos, school projects, customer presentations, interactive training or anywhere an extra edge of professional presentation counts.



Home Photos



Impress your friends



No more messy handwritten CD's



Business

Expensive manuals can now be replaced with interactive, low-cost professional looking CD's.

- Prints a full color CD in about a minute
- Compatible with all inkjet printable CD-R & DVD-Rs
- Special PC and Mac software and templates to print CD, liner notes and more
- Both USB connections
- Uses standard C60/C62 Epson inkjet cartridges
- Prints paper documents at 12ppm monochrome & 7ppm color
- Printer size: 18.0"W x 8.0"D x 7.0"H

Requires: Windows® 95/98/2000/ME/XP, Mac OS 8.1 or higher operating systems

Includes: Printer, PC and Mac printer and template software, three printable disks

Part No.	Description	1	5
220708CD	CD/paper printer	\$358.95	\$338.95
220716CD	100 pk. 40x 700MB 80 min. CD-R	48.95	47.45

Jacob Jensen Designed Phone – By Enzer

"Phones must be functional, but who said they should not look great?"

Enzer Electronics has positioned itself as a leader in the telecommunications technology industry that emphasizes the beauty and design of its products. The perfect blend between technology and visual arts will satisfy both your senses and your emotions. They offer more than just technology - it's about innovation and intelligent ideas that defy your expectations! Jacob Jensen, the world famous designer who has won over 100 international prizes and 18 of his works exhibited at the Museum of Modern Art in New York has teamed up with Enzer to bring you beauty and functionality in phones for your business or home office.

227125CD: 2 one-touch memory, 10 two-touch memory, mute/flash/pause function, ringer volume (Hi/Low), last number redial, desktop/wall mountable

227133CD: 10-digit LCD display, 3 one-touch memory, 10 two-touch memory, mute/flash/pause function, ringer volume (Hi/Low), last number redial, desktop/wall mountable

Part No.	Product No.	Description	Price
227125CD	ET-T1	Desktop/Wall mountable	\$79.95
227133CD	ET-T3	Desktop/Wall mountable with display	109.95

Additional Enzer Designer Phones see page 3

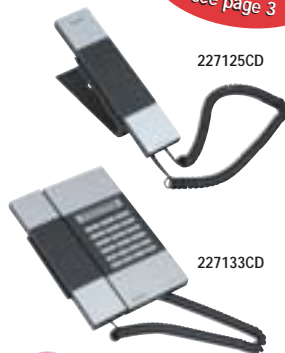

Glare Free Document Light and Holder

This ergonomically-designed document light and holder reduces glare, while creating a well-lit work area.

Optometrists recommend the Eclipse Document Light, especially if you work for more than two hours a day. Attaches to either side of your computer monitor.

Secure the cord to the back of the computer for clutter-free desk, turn on the energy efficient 10,000-hour bulb, and you will immediately notice the difference. Swings out of the way when not in use; adjustable height. Contemporary design blends in with any office decor.



Part No.	Description	Price
224311CD	Glare free document light and holder ...	\$29.95

For Eclipse Computer Light see page 2

Video Capture PCI Card with Camera

- Plug & Play PCI specific version 2.1 compliant
- CIF (common interface format) for image capturing
- True motion codec (compression & decompression)
- Video conferencing, video messaging, editing & manipulation :
- NTSC/PAL/SECAM composite video capture at a full 640 x 480 resolution with 24-bit color depth
- Capture and compress video at rates of 30 frames per second
- Size: 4.8"L x 2.2"W • Weight: 0.8 lbs.



SALE

System requirements: Windows® 95 or better; Pentium® 133MHz or better; 16MB of RAM; 46MB hard disk space, 4X CD-ROM; PCI video board with 2MB of memory; 640 x 480 display with 8-bit color depth; available PCI slot.

Includes: Manual on CD-ROM, CD-ROM drivers, and camera

Part No.	Description	1	10	25
180110CD	Video capture card	\$47.79	\$42.95	\$38.75

USB Color Video Camera

- Plug & Play compatible
- Sensor: 1/3" CMOS
- 640 (H) x 480 (V) pixels
- Minimum illumination: less than 15 lux
- Integrated lens: F2.0
- Resolution and output performance: VGA (640 x 480) up to 10 frames per second
- Size: 3.6"L x 2.1"W x 2.0"H
- Weight: 0.4 lbs.



SALE

System requirements: Pentium® 166MHz, 16MB of RAM, Windows® 98, USB port

Includes: CD-ROM drivers

Part No.	Description	1	10
204134CD	USB color video camera ...	\$29.95	\$26.95

ISA 16-Bit VGA Card

- Supports 16 colors; requires 1MB video RAM
- Supports VESA standard graphics and text modes
- Emulates VGA, EGA, CGA, MDA & Hercules modes
- 1024 x 768 resolution in non-interlaced/interlaced modes • Output HDDB15 female (analog)
- On board memory



Requirements: IBM AT and higher compatibles

Includes: Software and manual

Part No.	Description	1	10	25
104660CD	VGA card	\$49.95	\$44.95	\$39.95

PCI Graphics Accelerator Card

- High performance SIS6326 8MB PCI graphics accelerator
- 800K polygon/sec
- Supports texture, transparency, blending, wrapping and mirror, fogging and blending, point sampled, linear & bi-linear texture filtering
- Built-in direct draw accelerator & NTSC/PAL video encoder • 14-bits resolution in IDCT transformation
- Supports per pixel texture perspective correction and Z & alpha buffer
- Size: 5.5"L x 2.5"W • Weight: 0.4 lbs.



Includes: CD-ROM manual and drivers

Part No.	Description	1	10
210833CD	PCI accelerator card	\$39.95	\$35.95

AverKey Pro PC to TV Converter Box

- Converts VGA video or Macintosh® 640 x 480 to standard NTSC
- Built-in flicker filter
- Resolution: 800 x 600
- TV brightness control
- Compatible w/ Microsoft® Windows® 3.0 and higher
- Two-year warranty
- Size: 6.0"L x 4.0"W x 1.0"H • Weight: 2.2 lbs.



System requirements: VGA-based PC, DOS 3.0 or higher, 640KB RAM or larger

Includes: Compact PC to video converter box, transformer, cables and manual

Part No.	Description	1	10
167193CD	Video signal pro	\$109.95	\$99.95

15" SVGA Color Monitor†

- 0.28mm dot pitch
- Resolution: 1280 x 1024 @ 60Hz
- Digital panel control
- Input voltage: 100-240VAC, 50/60Hz (auto switching)
- Power, contrast, brightness, horizontal and vertical size position, recall and trapezoid front control
- HDDB15 male connector • UL/CSA/TUV approved
- Size: 14.5"W x 16"D x 14.6"H
- Weight: 45 lbs. † Refurbished



Requirements: IBM PC/XT or higher compatibles

Includes: Power cable, tilt and swivel base

Part No.	Description	1	10
153306CD	13.5" monitor viewable †	\$99.95	\$89.95

14" SVGA Color Monitor†

- 13" diagonal view
- 0.28mm dot pitch
- HDDB15 male connector
- Power, contrast, brightness, horizontal and vertical position, recall and trapezoid knob adjustments
- Resolution: 1280 x 1024 @ 60Hz
- Input voltage: 100-240VAC @ 50-60Hz
- Size: 14.2"W x 14.6"D x 13.5"H
- Weight: 25 lbs. † Refurbished



Requirements: IBM PC/XT or higher compatible

Includes: Power cable, tilt and swivel base

Part No.	Description	1	10
174537CD	13" monitor viewable †	\$69.99	\$64.99

PC Monitor Power Cables

- Allows connection of monitors directly to standard IBM type power supplies
- Monitor turns on/off automatically via system power switch
- IBM PC/XT and higher compatibles
- See page 49 for more power adapter cables

SALE



Part No.	Description	1	10	100
177447CD	1' monitor cable	\$2.95	\$2.49	\$2.15
26382CD	6' monitor cable	2.19	1.95	1.79



Pro-Video Editing Controller at Breakthrough Price

CommandPost is a pro-quality video-editing controller for your favorite video/multimedia applications at a new breakthrough special purchase price. Working with your favorite video/multimedia applications has never been easier or faster. Now the most popular controls such as jog wheel, fader, etc., from professional non-linear editors, DVEs and DDRs are brought to your desktop. Includes a free copy of VideoWave Version 4.0 video editing software plus templates for most popular video and graphics applications, including Videonics Effetto Pronto, Apple iMovie, Apple Final Cut Pro, Adobe Premiere, Adobe After Effects, and Digital Origin EditDV.

- Concentric jog/shuttle control
- Centering joystick with pushbutton
- Internally illuminated for readability in darkened edit rooms
- Fader arm, 15 tactile push-button switches
- Supports standard or user-defined keysets
- Easy assignment of control sequences and keyset names

System requirements: USB 1.1 compliant PC: Windows® 98 or 2000, Pentium® 133 or higher, 5MB RAM minimum, 8MB minimum hard disk space. MAC: O.S. 8.6 or higher, Power PC, 10MB of RAM minimum, 5MB min. hard disk space

Part No.	Description	Size	Weight	Price
220329CD	CommandPost	1.5"H x 10.0"W x 7.0"D	2.0 lbs.	\$29.95



Harman/Kardon Multimedia Amplified System

- 4.5 watt RMS per amplified speaker
- Transducer: 3" full range driver, magnetically shielded
- Frequency range: 90Hz to 20kHz
- Volume control, bass and treble control, LED indicator and headphone jack • Weight: 4.7 lbs.
- Size: 8.5"H x 4.5"W x 5.0"D (per speaker)



Includes: 16VAC @ 1A power supply

Part No.	Description	1	10
211001CD	H/K speaker system	\$14.49	\$12.95

SALE

480-Watt Multimedia Amplified Speakers

- Input voltage: 120VAC
- 2 speakers
- Magnetically shielded
- 2-channel stereo amplifier
- Push button type power switch with LED indicator
- Knob controls for volume, bass & treble
- Size: 5.5"W x 7.0"D x 9.1"H • Weight: 5.3 lbs.



Part No.	Description	1	10
196066CD	480W speakers	\$39.95	\$35.95

World Famous Boston Acoustics Self-Amplified Speaker and Subwoofer System

The key to this 3-piece outstanding speaker system is the 2 1/2" satellite speakers that deliver rich mid and high frequency response. Boston Acoustics employs advanced computer modeling to design drivers that reproduce seven audible octaves with remarkable accuracy and smoothness. The satellite speakers come with their own stand and MagnaGuard magnetic shielding to prevent video interference. The subwoofer delivers a robust room-filling sound that compliments the satellite speaker output.

BostonAcoustics



• Frequency response (±3dB): 56Hz – 20kHz
 • Maximum sound pressure level: 104dB
 • Cross over frequency: 240Hz
 • Master volume/power & sub-woofer volume switch
 • Satellite speaker size: 3.3"L x 3.3"W x 3.5"H
 • Subwoofer speaker size: 7.8"L x 6.0"W x 7.0"H
 • Weight: 6.0 lbs.

Includes: 12VAC @ 2A power supply

Part No.	Description	1	5
213911CD	Speaker/subwoofer system	\$64.95	\$59.95

COBY Omnidirectional Microphone Headset

- Frequency range: 20Hz to 20kHz (headset); 50Hz to 16kHz (microphone)
- Impedance: 32Ω
- Maximum power: 100mW
- Sensitivity: 98dB (headset); -62dB (microphone)
- Swivel microphone arm pivot
- Flexible microphone arm
- 6' cord • Two 1/8" phone jacks



Part No.	Description	1	10
153875CD	Microphone headset	\$10.95	\$9.95

Hands-Free Condenser Microphone

- Cord length: 8'
- Connector: 3.5mm male stereo plug
- Size: 1.9"L x 1.2"W x 0.3"H
- One-year warranty



Part No.	Description	1	10	50
135247CD	Microphone	\$3.69	\$3.15	\$2.35

Sennheiser Noise-Cancelling Headphones page 171



Mice & Trackballs

PS/2 2-Button No Tail Mouse

Perfect mouse for laptop and mobile power users. Extract cable to desired length in small spaces thus eliminating tangle and loose cables. Cable retracts into the body of the mouse for compact storage and mouse is switchable from PS/2 to serial.



- Retractable cable for laptop and power notebook users
- Switch selectable from PS/2 to serial mouse
- Adjustable to perfectly fit your limited computer work area
- Size: 4.5"L x 2.4"W x 1.1"H

Includes: PS/2 to serial adapter, retractable RJ11 modem cable, and carrying case

Part No.	Description	1	10
213330CD	PS/2 mouse	\$9.95	\$8.95

Single Button Apple Mouse

- 275 CPI resolution
- Soft, quick, responsive mechanical click button
- ADB connector
- 29" cord
- Size: 4.8"L x 2.4"W x 1.2"H
- One-year warranty



Part No.	Description	1	10	25
150480CD	Single button	\$16.95	\$15.49	\$13.95

3-Button Serial Mouse

- Microsoft® mouse compatible
- IBM PC/XT and higher compatibles
- Size: 4.3"L x 2.3"W x 1.2"H



Part No.	Description	1	10	50	100
104441CD	Serial mouse	\$4.95	\$4.49	\$4.05	\$3.65

Basic PS/2 2-Button Mouse

- Compatible with all major application software
- PS/2 connector (6-pin mini DIN)
- Size: 4.4"L x 2.5"W x 1.4"H



System requirements: IBM PC/XT/AT/PS/2 or compatible systems; Windows® 3.1/95

Includes: 3.5" drivers

Part No.	Description	1	10	100
174326CD	PS/2 mouse	\$7.95	\$6.95	\$6.25

QTRONIX Trackball with Menu Software

- Detachable wrist support
- Variable resolution (20-6400dpi)
- One million cycle life tactile switches
- Ergonomic design
- 3.5" disk
- Size: 5.5"L x 4.6"W x 2.0"H
- Weight: 1.2 lbs.



System requirements: IBM PC/XT & higher compatible systems; MS DOS 3.3 or later, Windows® 95 & higher

Part No.	Description	1	10	25
128995CD	LIBRA 90 MP NET ...	\$29.95	\$26.95	\$24.25

Mini Mouse Pad

- Tough non-skid neoprene backing
- Smooth-gliding cloth surface on top
- Size: 7.0"L x 5.5"W



Part No.	Description	1	10	100
121363CD	Mini mouse pad	\$2.95	\$2.55	\$1.89

See the yellow and green highlighted items.

Jameco Special Values!

Sale details are on page 4.

QTRONIX. Win 95 104-Key Keyboard with Jumbo Trackball



- PC/AT and PS/2 compatible w/ DOS 3.0 or higher
- "N-Key" roll-over for quick typists
- Tactile click sound and feel • Weight: 3.7 lbs.
- Size: 19.0"L x 6.8"W x 1.4"H • One-year warranty

Includes: Software and AT cable adapter

Part No.	Description	1	10	25
128717CD	Scorpius 35PM/NET	\$99.95	\$90.95	\$84.95

Space Saver Keyboards

Full featured AT & PS/2 mini keyboards save valuable desktop space.



Standard Keyboard

Mini Keyboards save up to 30% desk space!

SALE

- Adjustable tilt mechanism
- Tactile key stroke
- LED indicators for Num, Caps, and Scroll lock

114868CD



199718CD

199718CD: 83-key keyboard

- For PS/2 systems
- Auto repeat
- N-key rollover
- Size: 12.8"L x 6.2"W x 1.0"H
- Weight: 1.9 lbs.

114868CD: 84-key keyboard

- For AT systems, designed for Windows® 95
- Size: 12.8"L x 6.6"W x 1.0"H
- Weight: 2.4 lbs.



211756CD

211756CD: 88/89-key keyboard w/ touch pad

- For AT systems, designed for Windows®
- Built-in touch pad and embedded keyboard
- Soft touch membrane contact
- Size: 11.4"L x 8.5"W x 1.2"H • Weight: 2.3 lbs.

Part No.	Description	1	10	25
199718CD	83-key PS/2	\$49.95	\$44.95	\$38.95
114868CD	84-key AT	49.95	44.95	38.95
211756CD	88/89-key AT	59.95	53.95	48.95

Star Win 95 104-Key Keyboard



- For PS/2 systems
- Unmarked window keys
- LED indicators for Num, Caps and Scroll Locks
- 12 Function keys w/ separate arrow & numeric keys
- Tactile feedback • Tilt mechanism
- Size: 18.2"L x 7.0"W x 1.5"H • Weight: 2.7 lbs.

Part No.	Description	1	10	25
173649CD	104-key keyboard ..	\$12.95	\$11.49	\$9.95

Win 95 104-Key Keyboard



SALE

- IBM PS/2 and higher compatibles
- LED indicator for Num, Caps and Scroll Locks
- Tilt mechanism • Ergonomic style
- 12 function keys • Tactile key
- Use adapter P/N 85500CD, pg 185 for AT systems
- Size: 18.5"L x 7.0"W x 1.0"H • Weight: 2.7 lbs.

Part No.	Description	1	10	25
135482CD	104-key keyboard ..	\$10.95	\$9.95	\$7.95

QTRONIX. 108-Key Compact Keyboard



- IBM PC PS/2 or higher compatible
- Use adapter P/N 85500CD, pg 185 for AT systems
- LED indicator for Num, Caps, and Scroll Lock
- Supports Windows® 98 ACPI keys (wake-up, sleep, power) • 12 function keys
- High quality rubber mechanical key switches
- Size: 15.5"L x 6.5"W x 1.1"H • Weight: 1.9 lbs.

Part No.	Description	1	10	25
180347CD	Scorpius 2KP	\$39.95	\$35.95	\$32.49

COMPAQ 101-Key Keyboard



- For PS/2 systems • Tactile touch
- LED indicators for Num, Caps, and Scroll lock
- 12 function keys with separate cursor and numeric keys • Size: 18.3"L x 6.5"W x 1.3"H
- Recommend using adapter P/N 85500CD, pg 185 or P/N 159089CD, pg 194 • Weight: 3.6 lbs.

Part No.	Description	1	10	25
191530CD	101-key keyboard ..	\$19.95	\$16.99	\$12.75

117-Key Multimedia Keyboard



- For PS/2 systems
- Use adapter P/N 85500CD, pg 185 for AT systems
- LED indicators for Num, Caps, and Scroll locks
- ± volume buttons, mute button, forward / reverse/play/stop button for multimedia, WWW button, MS DOS button, My Doc button, Menu/? button, screen saver button, close button
- 12 function keys w/ separate cursor & numeric keys
- Size: 18.5"L x 7.0"W x 1.8"H • Weight: 3.6 lbs.

Includes: 3.5" drivers and keyboard labels for buttons

Part No.	Description	1	10	25
174334CD	Multimedia KB	\$6.95	\$6.25	\$5.65

QTRONIX. Win 95/98 107-Key PS/2 Red Keyboard



195821CD

SALE

- Tactile key stroke with high quality rubber mechanical switch • Adjustable tilt mechanism
- Opaque red or blue top cover & clear bottom cover
- IBM PS/2 and higher compatible
- Designed for Windows® 98 with ACPI keys (wake, sleep, and power) • Windows® 95 compatible
- Use adapter P/N 85500CD, pg 185 for AT systems
- Size: 18.6"L x 6.5"W x 1.1"H • Weight: 2.0 lbs.

Part No.	Product No.	1	10
195821CD	Scorpius 98A Red	\$7.95	\$6.45

For Keyboard Adapters and Cables – see page 185.



Phone
1-800-831-4242

Fax
1-800-237-6948

Online
www.Jameco.com



Order Anytime 24x7x365

PCI Ultra High-Speed I/O

Serial 16C550 and Parallel Port

- 32-bit PCI bus with PCI bus 2.1 specification compliant
- Serial ports are software configurable with throughputs up to 921.6kbps
- BPP/SPP mode compliant
- Windows® 95/98/NT 4.0 drivers supported



SALE

169594CD: 2 serial DB9M on card and 1 parallel DB25F panel bracket assembly

Part No.	Description	1	10
146691CD	Single parallel	\$39.95	\$35.95
163707CD	Dual parallel	49.95	44.95
146667CD	Dual serial (16C550)	38.95	36.95
169594CD	2 serial (16C550) and 1 parallel	59.95	53.95

PCI High-Speed I/O Combo Card

2 Serial 16C650 and 1 Parallel ECP/EPP Ports

- 16C650 UART compatible
- 2 ultra high-speed RS-232 ports and 1 high-speed ECP/EPP parallel port
- Serial port transfer rate up to 921kb/sec. and parallel port up to 2MB/sec.
- 32-byte FIFO buffer
- Supports IRQ sharing
- 32-bit PCI interface
- Plug & Play ready
- 2 DB9 male & 1 DB25 female connector w/ bracket
- Size: 4.7"L x 2.9"W • Weight: 0.6 lbs.



SALE

System requirements: 486/586 and higher compatibles; Windows® 95/98/NT/2000

Includes: Manual, DB25F panel bracket assembly and drivers on CD-ROM

Part No.	Description	1	10
172013CD	2 serial/1 parallel	\$53.95	\$48.59

PCI 4-Port I/O

2 Serial 16C650 and 2 Parallel ECP/EPP/SPP/BPP Ports

- Plug & Play compliant
- Serial port: SUN1889 chipset; 32-byte FIFO; compatible with 16C450/550/650 chip; RS-232 IEEE standard interface; 921kb/sec. transfer rate
- Parallel port: SUN1689 chipset, 32-byte FIFO; ACC3203/ST78C36/HT6535 compatible chips; ECP/EPP/SPP IEEE standard interface; 2Mb/sec. transfer rate
- 2 DB9 male connectors and 2 DB25 female connectors
- Size: 4.7"L x 3.6"W
- Weight: 0.8 lbs.

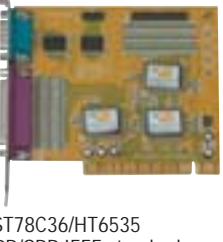

SALE

System requirements: 486/Pentium® & higher comp. Windows® 95/98/NT/2000; available PCI slot

Includes: Manual, cable and CD-ROM drivers

Part No.	Description	1	10
173260CD	PCI 4-port	\$53.95	\$48.59

PCMCIA RS-232 Interface

PC card / PCMCIA-based serial port card.

- Low cost single port RS-232 interface
- Uses 16550 UART
- 5, 6, 7 or 8 data bits
- Odd, even or no parity
- 115k baud data rates
- Configured as COM1, COM2, COM3 or COM4
- PCMCIA type II compliant



Includes: 1' cable

Part No.	Description	1	10
164451CD	PCM-COM232 card	\$119.95	\$104.95

Bidirectional Serial/Parallel Converter

115.2kbps, 512kb Buffer

- One DB25 female connector, one Centronics 36-pin male connector
- DCE/DTE selectable
- Fully compatible with Windows® 95
- Baud rate: 300bps – 115,200bps
- FCC class A certified, CE certified
- LED indicator for parallel busy status
- Stop bits: 1 or 2
- Size: 3.8"L x 2.4"W x 1.0"H • Weight: 0.8 lbs.



Includes: 9VAC @ 200mA adapter

Part No.	Description	1	10	50
182983CD	Converter	\$54.95	\$49.95	\$45.95



16-Bit Active-Slot PC Extension Interface

Gives you three additional expansion slots.

- Compatible with 8 or 16-bit ISA cards
- Supports: MONO/EGA/VGA/FDC/HDC, game and most I/O
- Control card installs inside your PC with four external slots
- Two mounting brackets to interface the unit via 37 and 62-pin cables
- Isolates system providing short circuit protection
- Can insert and remove cards while power is on
- Can be powered off the PC or externally using 6-pin connection (P/N 78318CD & P/N 78326CD, pg 135)
- One-year warranty
- Size: 9.5"L x 6.8"W x 1.0"H • Weight: 5.5 lbs.



System requirements: IBM PC/XT and higher comp.

Part No.	Description	1	10
131238CD	PC slot extender unit	\$279.95	\$251.95

ISA Dual-Port Game Card

- Enables two people to play a game at the same time
- Uses standard IBM type joysticks
- Two game ports

SALE

Requirements: IBM PC/XT and higher compatibles

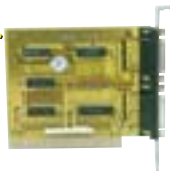

Part No.	Description	1	10	25
105515CD	Game card	\$4.95	\$4.49	\$4.19

PCI High-Speed Multi-Port Serial I/O

2, 4 or 8 16C650 Serial Ports

- 32-byte FIFO
- Plug & Play compatible
- Standard RS-232 interface
- Transfer rate: up to 921kb/sec.
- Supports IRQ sharing

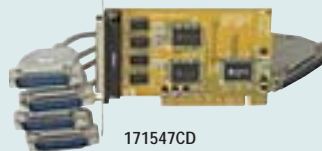

172005CD: Dual 16C650 Serial Ports

- Two DB9 male connectors
- Size: 4.7"L x 2.8"W • Weight: 0.5 lbs.

Includes: Manual and drivers on CD-ROM & floppy

171547CD: Quad 16C650 Serial Ports

- Size: 4.7"L x 2.8"W • Weight: 0.9 lbs.

Includes: Manual, cable (37-pin male to 4 DB25 male) and drivers on CD-ROM

171660CD: Eight 16C650 Serial Ports

- Size: 6.5"L x 3.6"W • Weight: 1.8 lbs.

Includes: Manual, internal cable with bracket, 2 cables (37-pin male to 4 DB25 male) and drivers on CD-ROM

System requirements: 486 and higher compatibles, Windows® 95/98/NT/2000

Part No.	Description	1	10
172005CD	2-port PCI serial	\$59.95	\$53.95
171547CD	4-port PCI serial	129.95	116.95
171660CD	8-port PCI serial	179.95	161.95

PCI Single-Port Serial I/O

Single 16C550 Port

- Plug & Play ready
- Transfer rates up to 921kb/sec.
- 32-bit PCI bus interface
- 32-byte FIFO
- Supports IRQ sharing
- Size: 4.8"L x 1.8"W
- One-year warranty



System requirements: 486/Pentium® and higher compatibles; Windows® 95/98/NT/2000

Part No.	Description	1	10
171361CD	Single serial	\$38.95	\$35.95

ISA 2-Port High-Speed Serial I/O

Dual 16C650 Serial Ports

- 32-byte FIFO
- IRQ (3, 5, 7, 9, 10, 11, 12, 15) and address jumper configurable
- DB9 male connector
- Size: 5.0"L x 2.0"W



System requirements: 486/586 or higher compatibles, Windows® 95/98/NT

Includes: Manual and drivers on CD-ROM

Part No.	Description	1	10
172380CD	Dual serial	\$19.99	\$18.99

30-Day Money Back Guarantee

If you're not satisfied we'll take it back!

Details on page 217.



ISA High-Speed 4-Port Serial I/O

Quad 16C650 Serial Ports

- 32-byte FIFO
- 16-bit ISA interface
- MS-DOS, Windows® 3.x, 95 and NT compatible
- Four 16C650 ultra high-speed serial ports
- Supports COM 1-8 & IRQs 3-15 (jumper selectable)
- Size: 6.2"L x 4.3"W
- One-year warranty
- Weight: 1.2 lbs.



System requirements: IBM PC/AT & AT compatibles
Includes: 37-pin male to 4 DB25M cable and manual

Part No.	Product No.	1	10
152291CD	4042A	\$54.95	\$49.95

ISA 4-Port Serial I/O

Quad 16C550 Serial Ports

- High-speed 16C550 UARTs with 16 or 32-byte FIFO
- 4 serial ports; 2 each DB9M and DB25M
- IRQs: 3, 4, 5, 9, 10, 11, 12, or 15
- Supports IRQ sharing
- Weight: 0.7 lbs.
- One-year warranty



COM Address	COM Address	COM Address	COM Address
1 3F8	5 3F0	6 3E0	7 2E0
2 2F8	6 3E0	7 2E0	8 260
3 3E8	7 2E0	8 260	
4 2E8	8 260		

System requirements: IBM AT & higher compatibles
Includes: DB25 male and DB9 male panel bracket assembly and instruction sheet

Part No.	Description	1	10
132572CD	4-port hi-speed serial	\$59.95	\$53.95

ISA 2-Port Parallel

21.4MB/Sec. Bidirectional

- Supports EPP/ECP/SPP+BPP/ECP+BPP
- Supports 770kB/sec. transfer rate in EPP/SPP/BPP modes
- IRQ: 3/4/5/7/9/10/11/12/15 and address selectable per port
- Compatible with color printers, scanners, plotters, ZIP drives and MP3 players
- 1 external DB25 female connector and 1 internal 26-pin male header
- Weight: 0.6 lbs.

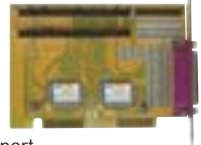

System requirements: 75MHz or higher compatible, 32MB RAM, 16-bit ISA slot, Windows® 95/98/ME/NT/2000

Part No.	Description	1	10	25
132214CD	2-port printer	\$27.95	\$25.15	\$22.65

ISA 2-Port High-Speed Serial I/O

Dual 16C650 UART Ports

- 16-byte FIFO
- Transfer rates up to 921kb/sec.
- Dual high-speed serial ports
- 2 DB9 male connectors
- IRQ (3, 5, 7, 9, 10, 11, 12, 15) and address jumper configurable
- Size: 5.0"L x 2.7"W
- Weight: 0.5 lbs.



System requirements: 486/586 and higher compatibles; Windows® 95/98/NT/2000

Includes: Manual and drivers on CD-ROM

Part No.	Description	1	10
171555CD	Dual serial	\$24.95	\$21.85

PCI Ultra High-Speed Parallel

Single Ultra High-Speed Port

- Supports ECP and EPP
- 32-byte FIFO
- Transfers data up to 2MB/sec.
- Supports IRQ sharing
- Plug & Play ready
- 1 DB25 female connector
- 32-bit PCI interface
- Size: 4.7"L x 2.2"W
- Weight: 0.5 lbs.

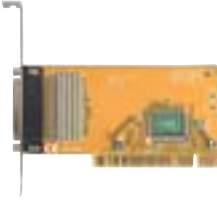

System requirements: 486/586 and higher compatibles; Windows® 95/98/NT/2000

Includes: Manual and drivers on CD-ROM

Part No.	Description	1	10
171926CD	PCI single parallel	\$39.95	\$35.95

ISA Single-Port Parallel

Single Bidirectional Parallel Port

- Single standard and bidirectional port
- Jumper selectable for printer address and port (LPT1 - LPT3)
- Jumper selectable for IRQ addressing (3, 4, 5, 7, 9)
- Size: 4.0"L x 2.0"W
- One-year warranty



System requirements: PC/XT/AT and higher

Part No.	Description	1	10	25
155660CD	Printer card	\$19.95	\$17.95	\$14.95

Controller Cards

ISA Fast SCSI-II Controller

- Compatible with DOS, Windows®, Windows® NT, Windows® 95, OS2 Netware, and SCO Unix
- Internal and external SCSI-II connectors
- Size: 6.3"L x 2.9"W
- Weight: 0.6 lbs.
- One-year warranty



Includes: Setting sheet, ribbon cable, and software (3.5" disk)

Part No.	Description	1	10
149294CD	ISA SCSI-II controller	\$44.95	\$39.95

PCI Ultra-II SCSI Controller

- AIC-7890AB chipset
- Windows® 95/NT, NetWare, OS/2 compatible
- Plug & Play design
- Internal and external Ultra-II SCSI 68-pin connectors
- Supports Ultra-II SCSI peripherals at speeds up to 80Mbytes/sec. or Ultra/UltraWide peripherals up to 40Mbyte/sec.
- Supports up to 15 SCSI peripherals
- Size: 6.0"L x 3.5"W
- Weight: 0.3 lbs.



SALE

Part No.	Description	1	10
191513CD	Ultra-II SCSI	\$105.49	\$94.95

PCI Ultra ATA/133 Controller Card

Supports IDE devices to transfer data at maximum burst rate of 133Mbytes/sec. Backward compatible with all ATA/66 and ATA/100 IDE devices.

- Supports 4 IDE devices
- 133Mbytes/sec burst data rate on PCI local bus and IDE bus
- Enhanced BIOS on board
- Widest range of compatible IDE/ATAPI devices
- Supports Windows® 98/ME/NT4.0
- Size: 5.2"L x 2.5"W



SALE

Includes: 80-wire/40-pin cable, 3.5" drivers & manual

Part No.	Description	1	10
208021CD	Ultra ATA/133 controller	\$44.95	\$39.95

Computer Cables on pages 172 & 184



ISA IDE Super 16-Bit I/O Plus

Supports 2 IDE and 2 Floppy Drives

- Parallel printer port interface (P/N 131318 is bidirectional)
- Game port
- Two RS-232 serial ports
- UART emulation: 67061CD: 16450; 131318CD: 16550
- Weight: 0.9 lbs.
- One-year warranty

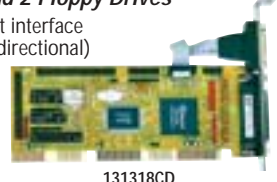

Includes: Manual and cables

Part No.	Description	1	10
67061CD	16450 UART I/O	\$14.95	\$13.49
131318CD	16550 UART I/O	29.95	26.95

ISA Controller Card

- 16-bit data transfer which is fully compatible with IBM PC/AT interface
- Supports two floppy disk drives (360k, 720k, 1.2Mb, 1.44Mb)
- Controls two "AT BUS" hard disk drives
- High bandwidth host interface works up to 16MHz host I/O clock
- Size: 5.5"L x 2.1"W



Part No.	Description	1	10
206316CD	ISA controller card	\$19.95	\$17.95

Portable Data Loggers



onset computer corporation H8 Portable Data Loggers

Temperature/Relative Humidity/Light Intensity/External Sensor Input

- Sensors included (except external sensor input)
- External input accepts external temperature sensors, AC current, 4-20mA and 0-2.5 VDC
- Requires BoxCar software, right
- Capacity: 7943 measurements total except 194108CD is 32,520 measurements total
- User selectable sampling intervals 0.5 sec. to 9 hours; recording time to one year
- Nonvolatile EEPROM memory retains data even if battery fails
- Internal temperature sensor on 4" wire can extend from case
- User replaceable battery lasts one year • Programmable start time/date
- Operating ranges: -4 F to +158 F (temperature), 0 to 95% relative humidity (non-condensing, non-fogging), 2 to 6000 foot candles light intensity (lumens/ft²)
- Size: 2.4"L x 1.9"W x 0.8"D



194061/194079: 2 channel
194108/194095: 4 channel

Part No.	Product No.	Description	1	10
194061CD	H08-002-02	Temperature/external input	\$63.95	\$59.95
194079CD	H08-003-02	Temperature/relative humidity	83.95	79.95
194108CD	H08-006-04	External inputs	94.95	85.45
194095CD	H08-004-02	Temperature/relative humidity/light intensity/external input	93.95	89.95

BoxCar Software for Hobos

BoxCar 3.7 provides basic launch, data readout, plotting and data export capabilities. BoxCar Pro 4.0 is a powerful enhanced version of BoxCar 3.7, offering added features for graphing, data analysis and simultaneous management of multiple loggers.

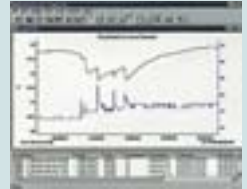

194167CD

Easy Logger Set-up:

- Select from predefined or custom sampling intervals (0.5 seconds to 9 hours)
- Set start time and memory modes
- Check battery status
- Export data to Microsoft Excel

BoxCar 3.7:

- View data in tabular and graphical formats
- Display multiple plot windows at once

BoxCar PRO 4.0:

- Powerful graphing capabilities allows user to compare multiple parameters on one graph
- Zoom and axis control data
- Analysis functions to extract key
- Other features include long file names, print preview, print graphs and series details



Part No.	Product No.	Description	1	10
194159CD	BC3.7-ON	BoxCar 3.7	\$13.95	\$13.30
194167CD	BCP4.0-ON	BoxCar PRO 4.0	94.95	89.95

Industrial Communications

ATEN RS-232 to RS-485/422 Bidirectional Converters

- Cable length: 4000' max.
- Data rate: 1MB/second
- 4-wire full duplex or 2-wire half duplex
- Controlled by RTS signal
- DCE and DTE selectable
- Point-to-point and multidrop operations
- RS-485: terminal block and RJ11 connections
- RS-232: DB25 female connector
- Input: 110VAC; except P/N 129218CD 220VAC input
- Weight: 0.9 lbs.
- One-year warranty



117701CD



- 197931CD: port powered
 - Data rate: 100kbps
 - 122956CD: features RS-485SI optical isolation: 2000V
 - 129218CD: features RS-220VAC input
- Includes: 9VDC @ 300mA power adapter

Part No.	Description	1	10
117701CD	RS-232-485/422	\$57.95	\$51.95
197931CD	RS-232-485/422	69.95	62.99
122956CD	RS-232-485/422 OPT ISO	119.99	107.99
129218CD	RS-232-485/422 (220 VAC)	42.95	36.95

PCI GPIB IEEE-488.2 Board



PCI Bus

- 1 MB/s transfer rates • 1024 word FIFO buffer

Part No.	Mfr. Cross Ref. No.	1	10
177121CD	PCI-GPIB-1M	\$398.95	\$358.95

ISA 48-Bit Digital I/O Card



- 48 TTL/DTL I/O lines; 8-bit ports
- Software programmable
- Interrupts: jumper-selectable to IRQ 2, 3, 4, 5, 6 or 7
- Buffer for high sinking capacity
- Added pull-up resistor: CMOS/DRY CONTACT compatible
- ISA bus
- IBM PC/XT and higher compatible
- Size: 10.2"L x 3.9"W • One-year warranty

Part No.	Description	1	10
136784CD	48-bit digital I/O card	\$109.95	\$98.99

Single Board Precision DVM

Designed for simple programming and parameter changing. With its on-board ALD500 and ALD523 chipset, running on a standard 5VDC power source, you have an economical, high-resolution digital voltmeter. Interfaces with most industry standard 16 x 2 LCD/VFD character display modules via 14-pin direct cable connection. With its on-board 1K EEPROM, you can calibrate and program the unit through a parallel port.

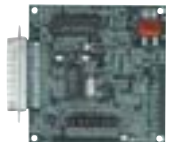

Software



Display



- 3 1/2 to 6 1/2-digit display resolution
- Up to 7 full digits plus sign (±9999999) display
- For embedded system applications
- Up to 3 sets of full scale display ranges
- Provisions to convert/scale any DC voltage to user-defined DISPLAY parameters
- Extra port to convert/scale serial digital input date to user-defined DISPLAY parameters
- Software/instructions diskette
- Compatible with P/N 171715CD (pg 99)
- Board size: 3.0"L x 3.0"W

Part No.	Product No.	1	10
208653CD	MB203A2V	\$94.85	\$85.95

We'll match the advertised price of any like product.

Jameco's Low-Price Guarantee

It's that simple!

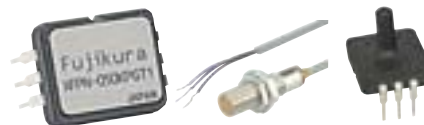

See page 105 for sensors.



Digital Data Acquisition and Control Board

- 8-channel A-to-D
- 12-bit resolution
- $\pm 5V$ input range
- Z_{in} : 50M Ω
- Software available on page 180

Includes: InstaCal: installation and test utilities software

PCI Bus

- Digital I/O: 3 input/4 output
- Three 16-bit counters
- 50kHz sample rate
- Data transfer: S/W polled, may be IRQ driven
- For terminal board, enclosure and cable, see below



Part No.	Product No.	1	5
193922CD	PCI-DAS08	\$247.95	\$222.95

Digital Input/Output Boards – TTL Level

- Output: 2.5mA @ 0.45V sink, 2.5mA @ 2.4V source
- Software available on pg 180

Includes: InstaCal: installation and test utilities software

PCI Bus

- 24-bit digital I/O
- Three 8-bit ports:
- For terminal board, enclosure and cable, see below



Part No.	Product No.	1	10
197827CD	PCI-DIO24	\$88.95	\$85.95

ISA Bus

- 24-bit (P/N 151511CD) or 48-bit (P/N 136784CD) digital I/O
- 8-bit ports



Part No.	Product No.	1	10
151511CD	CIO-DIO24	\$98.95	\$89.09
136784CD	AX5214H	109.95	98.99

Opto-Isolated Digital Input and Relay Output Board

- PCI Bus
- Input range: 5-24VDC or VAC, 50-1000Hz; Rin: 450 Ω
- 8 relay outputs: 5 form-C, 3 form-A (28VDC @ 6A, 120VAC @ 5A; contact R = 100m Ω)
- Opto-isolated inputs: 500V isolation channel-to-channel and channel-to-ground
- For terminal board, enclosure and cable, see below



Part No.	Product No.	1	10
197843CD	PCI-PDIS08 (PCI)	\$248.95	\$223.95

Opening an account is easy!!

Corporate Customers

Call 1-800-831-4242 for details today.

PC-Based Data Acquisition Software

Graphical Programming Software for Measurement Computing Boards

SoftWIRE is a graphical program for Visual Basic; one window holds the graphical program while the other window holds the user interface on a Visual Basic form. By simply using the 130+ functions with the software, you can make connections to the computer wires, provide your options, then run the program. While you are creating all these functions and connections, the software also provides the code in Visual Basic.

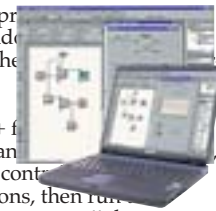

System requirements:

- Pentium® 90 or higher, Windows® 95/98/2000/ME/NT4.0, VGA or higher resolution monitor and Microsoft® Visual Basic 6.0 or later
- Any Measurement Computing DAQ or GPIB board

Part No.	Description	1	5
194028CD	SoftWIRE/VB-PPD	\$493.95	\$443.95

Data Acquisition Direct to Excel

DAS-Wizard is an add-in for Excel that controls your Measurement Computing data acquisition board and places your measurements directly into a worksheet. A simple configuration of the data range of cells to place measurements.



SALE

System requirements:

- PC with Pentium® 90 or higher
- Windows® 95/98/2000/ME/NT4.0
- Microsoft® Visual Basic 6.0 or later
- VGA or higher resolution monitor
- Any Measurement Computing DAQ board (left)

Part No.	Description	1	10
197851CD	DAS-Wizard	\$139.95	\$125.99

Terminal Boards, Enclosures and Cables for the Above Boards

Part No.	Product No.	Description	1	5
193965CD	CIO-MINI37	Terminal board	\$68.95	\$62.10
193973CD	ENCMINI-37	Enclosure	28.95	26.10
193949CD	C37FF-2	Cable (ribbon)	24.95	22.50
193957CD	CF37FFS-5	Cable (shielded)	34.95	31.50



193973CD shown with P/N 193965CD (not included)

193957CD

193949CD

The Basics of PC-Based Data Acquisition, Analysis, and Control

Using your PC as a platform for the acquisition, analysis and control of physical data is both powerful and economical. Simply adding a card with analog and digital data acquisition and control capability, or a module connected via a serial port, along with easy-to-use software, turns your desktop or laptop computer into a sophisticated instrumentation system.

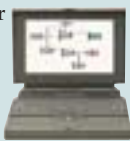

A PC-based data acquisition and control system is comprised of five fundamental elements: sensors/transducers, analog-to-digital conversion with signal conditioning, digital sensing, analog and/or digital control, and software. The first consideration is the physical parameter or



condition you wish to measure & record; it could be temperature, pressure, acceleration, vibration, sound intensity, and much more. Transducers convert physical parameters to electrical signals. Many transducers require signal conditioning (amplification, filtering, etc.), which is usually provided by the data acquisition card.

See Sensors On Page 105

For most PC-based data acquisition systems, analog-to-digital conversion is typically handled with a plug-in board or card – commonly known as DAQ boards (PCI, ISA or PCMCIA type). Alternately, a DAQ module connected via a serial port can be used. The key function of a DAQ board or module is to convert the analog signals coming in from the sensors into digital

signals with which the PC can deal. The primary specifications to look for are number of channels, resolution, and sample rate.

Virtually all DAQ boards and modules also have the capability of sensing digital input signals; for example, switch contacts. These signals are often used to initiate acquisition of analog data.



Once the data has been acquired & processed by the PC, the analog and digital output capability of a DAQ board can be used for control; i.e., “closing the loop”.

A popular software program, SoftWIRE, is built in two windows. The first window holds the graphical program while the other window holds the user interface on a Visual Basic form.

ATEN 5-Port USB 2.0 PCI Card

40 Times Faster Than the Original USB!

USB 2.0 will offer enhanced functionality, allowing more devices to share the increased bandwidth.



- Supports high speed data transfer rate of up to 480 Mbps
- Full backwards compatible with USB 1.1
- Supports Windows® 98SE/2000/ME/XP
- Hot swappable Plug & Play
- 1 internal USB-A port
- 4 external USB-A ports
- PC Power Management v2.2 compliant

Part No.	Description	1	10
197940CD	5-port USB 2.0 PCI card	\$54.95	\$49.49

USB Thumb Drives

What better way to keep your data safe than to keep it close to you?



Thumb drives are compact and fit easily in your pocket or hang it around your neck. Portable and lightweight, no external power needed. No drivers necessary for Windows® ME and above.

- 10 year data retention
- Size: 2.9"L x 0.7"W x 0.4"H
- Windows® 98/98SE drivers are available at www.Jameco.com

SALE

Part No.	Description	1	10
217752CD	16MB	\$29.95	\$27.95
217761CD	32MB	36.95	34.95
217779CD	64MB	51.95	48.95
217787CD	128MB	87.95	79.95
217795CD	512MB	289.95	279.95

New Lower Prices

Combo IEEE 1394 and USB 2.0 PCI Card

Create your own videos with this combo PCI card.



- Fully IEEE 1394 (firewire) OHCI compliance
- 133Mbps PCI bus master DMA transfer rate
- 400Mbps transfer rate on IEEE 1394 and 480Mbps transfer rate on USB 2.0
- Supports USB 1.0 and OHCI specifications
- 2 external and 1 internal IEEE 1394 connector
- 3 external and 1 internal USB connector
- Supports Windows® 98/ME/XP/2000 and MAC OS
- Board size: 4.8"L x 3.5"W

SALE

Includes: ULEAD VideoStudio software on CD-ROM, drivers and utilities on CD-ROM, internal power cable, IEEE 1394 cable, internal power cable, and manual

Part No.	Description	1	10
208477CD	PCI USB	\$89.95	\$81.95

2-Port USB-A PCI Card

- Plug & Play compatible
- Uses VIA VT83C572 controller chip
- USB specification V.1.1 compatible
- USB legacy BIOS supports
- Operates in USB-aware operating system (Win® 95, 98)
- Size: 4.7"L x 2.0"W
- One-year warranty



Includes: Manual

Part No.	Description	1	10	25
155299CD	PCI USB	\$24.99	\$22.49	\$20.25

4-Port USB-A PCI Card

- OPTI 82C862 chipset
- Full compliance with USB Spec Rev 1.1
- PCI specification V.2.1 compliant
- Plug & Play compatibility with external devices
- Auto detects speed and connection of devices
- Tiered star topology supporting up to 5 tiers and 127 devices
- Size: 4.9"L x 3.7"H



SALE

System requirements: IBM or compatible with 586 or higher processor; 64MB of memory; available PCI slot; Windows® 98 or higher

Part No.	Description	1	10	25
189042CD	PCI USB	\$25.95	\$22.65	\$18.75

2-Port USB-A CardBus PC Cards

- PCMCIA type-II card
- New 32-bit CardBus
- Size: 4.6"L x 2.1"W

SALE

208047CD: USB 2.0 EHCI USB standard; 480Mbps max.
189499CD: USB 1.1 OHCI USB standard; 12Mbps max.



System requirements: Windows® 98, ME, 2000, and Mac OS 8.6 or later

Part No.	Description	1	10
208047CD	USB 2.0 CardBus PC Card ...	\$89.95	\$79.95
189499CD	USB 1.0 CardBus PC Card	55.95	49.95

Firewire CardBus PC Card

Designed to connect Firewire devices to any notebook computer. With its two external ports, you can have 63 devices on the same ports with a max speed for 400Mbps. A mini DC jack is provided on the card for IEEE 1394 devices that require power through the cable.



- Fully IEEE 1394 OHCI compliance
- 133MB/s CardBus master DMA transfer rate
- Real time transmission data
- Open architecture API
- Peer to peer communication structure
- Backward compatible speeds
- 32-bit bus
- Increases efficiency of data transactions while simplifying software driver designs
- Supports Windows® 98SE/ME/XP/2000 & Apple® MAC OS 8.6 or above
- Size: 4.7"L x 2.1"W

Includes: 6' Firewire cable, manual, and ULEAD VideoStudio software

Part No.	Description	1	10
215984CD	Firewire CardBus PC Card	\$89.95	\$79.95

USB-A to Joystick (DB15) Adapter

- Fully compatible with any 15-pin game port PC game controller
- Mode switch selector for maximum compatibility and flexibility
- Input connector: USB-A male
- USB Plug & Play
- Output connector: DB15-pin female connector
- Size: 3.2"L x 2.3"W x 1.3"H



System requirements: 586 or higher compatible; available USB-A port or Hub; Windows® 98 or higher

Includes: Manual and 3.5" drivers

Part No.	Description	1	10
189510CD	USB to game port adapter	\$39.95	\$31.99

External 3-Port USB Thumbhub

Expand your single USB port to a stacked 3-port thumbhub.



- USB Revision 1.1 compliant
- Downstream port with OCD (over current detection) and OCP (overcurrent protection)
- LED indicators uplink/down port communication, and OCP status
- Supports full speed (12Mbps) and low speed (1.5Mbps) transfer rate
- Self-powered mode
- Compatible with Windows® 98/98SE/2000/ME/MAC OS8.5
- Size: 3.1"L x 0.8"W x 1.2"H

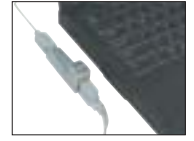

Part No.	Description	1	10
208451CD	3-port thumbhub	\$18.95	\$16.95

External USB 2.0 4-Port Hub

This hub allows you to connect and add any USB 2.0 peripherals to your PC. USB 1.1 backward compatible allowing all previous devices that you may have to function as usual.



- Supports 1.5Mbps low speed, 12Mbps full speed, and 480Mbps high speed data transfer rate
- One USB-B female upstream port and 4 USB-A female downstream port
- Connects up to 127 devices through cascading multiple hubs
- Supports self-powered mode
- Size: 4.0"L x 2.4"W x 1.0"H
- Weight: 1.3 lbs.

SALE

System requirements: Pentium® 233MHz or higher and MAC PCs, 64MB of RAM, available USB port, Windows® 98SE/ME/2000/XP/Mac OS

Includes: 5VDC@4A power supply, USB-A male to USB-B male cable, and manual

Part No.	Description	1	10
209007CD	4-port hub	\$41.95	\$38.29

External 7-Port USB Hub

- 7 USB-A female output ports
- USB-B female root port
- Plug & Play compatible
- Allows you to attach 127 USB devices to your PC
- LED indicators for port, status, and power
- Size: 7.9"L x 2.8"W x 1.1"H
- Weight: 2.6 lbs.



Includes: 6VDC power adapter and USB-A male to USB-B female cable

Part No.	Description	1	10
191450CD	7-Port USB hub	\$35.95	\$26.95

For Additional USB Products

Printers

Page 174

Cameras

Page 175



USB-A Female Cables & Bracket

- Supports data transfer rates of 12Mbps
- Allows connection of two devices
- Dual USB-A female connectors • 8" long



Part No.	Description	1	10	25
144813CD	USB-A panel mount ..	\$6.95	\$6.25	\$5.59

USB Gender Adapters

USB-A to USB-B

- 169383CD: USB-A (male) to USB-B (female)
- 169375CD: USB-A (female) to USB-B (male)



Part No.	Description	1	10	25
169383CD	1.3"L x 0.4"W	\$6.95	\$6.35	\$5.59
169375CD	1.7"L x 0.6"W	6.95	6.35	5.59

USB 2.0 Cables



- Higher transfer rate up to 480Mbps
- Color: black

USB-A Male to USB-A Male

Part No.	Description	1	10	25
222033CD	6' cable	\$6.49	\$5.99	\$5.69
222041CD	10' cable	7.99	7.19	6.49
222050CD	15' cable	11.69	10.49	10.49

USB-A Male to USB-B Male

Part No.	Description	1	10	25
222607CD	3' cable	\$5.99	\$5.39	\$4.99
222009CD	6' cable	6.49	5.99	5.69
222017CD	10' cable	7.99	7.19	6.49
222025CD	15' cable	12.99	11.69	10.49

USB-A Male to USB-A Female

Part No.	Description	1	10	25
222068CD	6' cable	\$7.99	\$7.19	\$6.49
222076CD	10' cable	9.99	8.99	7.99
222084CD	15' cable	14.99	13.49	11.99

ATEN USB-to-Centronics Printer Cable

USB-A Connector

- Full compliance with the USB spec V.1.0
- USB-A male to 36-pin male centronics connector
- Supports true bidirectional communication
- Applicable to standard and bidirectional printers



Part No.	Description	1	10	25
155352CD	6' USB cable	\$29.95	\$26.95	\$23.95

USB Cable Extenders

- Extends the distance between USB devices by up to 16'
- Complies with USB electrical and timing specifications
- Compatible with high and low speed USB devices
- Interface: USB-A male to USB-A female
- Size: (adapter): 2.8"L x 1.5"W x 0.6"H
- Weight: 1.0 lb.



Includes: USB-A male to USB-B female cable

Part No.	Description	1	10	25
191433CD	8' USB extender	\$16.59	\$14.89	\$13.49
191441CD	16' USB extender	29.50	25.09	18.85

USB to Serial Adapter with Prolific Chipset

This USB serial adapter provides an external Plug-and-Play RS-232 port for computers, notebooks, laptops, and handheld held computing devices. Provides high-quality serial connections at transfer rates of more than 500kbps for cell phones, PDAs, digital cameras, modems and ISDN terminal adapters. Since it is a USB connection it eliminates the hassles of traditional serial port connections and IRQ conflicts, thus more devices can be attached to the system.



- Frees existing RS-232 ports for other uses
- Supports RS-232 serial interface, automatic handshake mode, remote wake-up and power management
- Over 500kbps data transfer rate
- Provides a 96-byte buffer for each upstream and downstream data transfer
- Full compliance with USB specification v 1.1
- Has a 7" cable with DB25 male connector and a 14" cable with USB-A connector
- Size: 2.7"L x 1.6"W x 0.7"H • Weight: 1.5 lbs.

System requirements: Windows®98/2000, USB host controlled installed in the system

Includes: 3.5" software and manual

Part No.	Description	1	5
213006CD	USB-A to Serial converter	\$29.95	\$27.95

External USB-A IrDA Transceiver

Convert your USB port into an infrared communications port to transfer data from you PDA, notebooks, camera, cellular phone, and other mobile devices.



- Adjustable base for height and angle
- Supports standard USB port
- Plug & Play
- Meets IrDA v1.0 and v1.1
- Supports data transfer rate from 115.2k up to 4Mbit per second
- Transmission distance of 3.3' or 39.4"
- Size: (including base) 2.4"L x 1.6"W x 0.9"H

System requirements: Windows® 98/ME/2000/XP

Includes: Manual, extension cable and 3.5" disk software drivers

Part No.	Description	1	10
213903CD	USB-A to IrDA Transceiver ...	\$49.95	\$44.95

Retractable USB and Firewire Cables



Carrying all those extra cables for your computer peripherals such as printers, cameras, zip drives, external hard drives, adds weight and gets tangled in your computer bag. With these retractable USB and Firewire cables, you can easily store them in an inside pocket of your bag, plus they are tangle free. Just pull the cable on both ends of the spool and you have a high quality cable that extends to over 2'. Simply pull again and it retracts back into its housing.

USB cables

Part No.	Description	1	5
226376CD	USB A male to female	\$11.95	\$10.95
226368CD	USB A - B	11.95	10.95
226384CD	USB A - Mini 4-pin	11.95	10.95
226392CD	USB A - Mini 5-pin	11.95	10.95

Firewire cables

Part No.	Description	Price
226405CD	4-pin M - M, 400Mbps	\$13.49
227424CD	6-pin M - 4-pin M 400Mbps	15.95
227459CD	6-pin M - M 400Mbps	14.95

USB Cables



USB-A Male to USB-A Male

Part No.	Description	1	10	25
196904CD	2' cable	\$1.99	\$1.79	\$1.59
175425CD	3' cable	2.95	2.65	2.39
175433CD	6' cable	4.95	4.49	3.95
175441CD	10' cable	5.95	4.49	3.15

USB-A Male to USB-B Male

Part No.	Description	1	10	25
175417CD	3' cable	\$4.49	\$3.99	\$3.59
169359CD	6' cable	4.95	4.49	3.95
169367CD	10' cable	5.95	5.25	4.59

USB-A Male to USB-A Female Extension

Part No.	Description	1	10	25
199793CD	6' cable	\$4.95	\$4.49	\$3.95
199806CD	10' cable	5.95	4.49	3.15

IEEE 1394 Firewire Cables



Connect your computer to the latest high speed Firewire peripherals.

- IEEE-1394 compliant
- UL approved
- Molded connectors
- Length: 6'

Part No.	Description	1	10	25
175821CD	4-pin M - M	\$15.95	\$14.49	\$12.95
175839CD	6-pin M - 4-pin M	11.95	10.74	9.49
175847CD	6-pin M - M	9.95	8.94	8.04

RGB Video Cables

- 75Ω coaxial cable; 6' or 10'
- Pin 1 red, pin 2 green, pin 3 blue, pin 14 white/black vertical, pin 13 gray horizontal
- 5 BNCs to HDDB15-pin male



Part No.	Description	1	10	25
73648CD	6' cable (black)	\$19.95	\$17.95	\$16.15
118068CD	10' cable (black)	31.95	28.95	21.95

Serial Null Modem Cables

- Molded type connectors
- Color: gray



- 181403CD/180697CD Pin outs:**
1-7 & 8; 2-3; 3-2; 4-6;
5-5; 6-4; 7 & 8-1
- 181438CD Pin outs:** 2-2; 3-3;
5 & 6-4; 7-5; 8-7; 20-6 & 8
(Serial Printer Null Modem)
- 180582CD Pin outs:** 2-2; 3-3;
4-5 & 6; 5-7; 6 & 8-20; 7-8;
(Serial Printer Null Modem)
- 180742CD Pin outs:** 1-4 & 5; 2-;
3-3; 4-6; 5-7; 6-20; 7-8; 8-8



Part No.	Description	Wt. (lbs.)	1	10	50
181403CD	6' DB9 F to DB9 F	0.3	\$5.69	\$5.09	\$4.59
180697CD	10' DB9 F to DB9 F	0.4	6.79	6.09	5.49
181438CD	6' DB25 M to DB9 F	0.4	4.95	4.49	3.95
180582CD	10' DB25 M to DB9 F	0.4	6.69	6.05	5.45
180742CD	10' DB25 F to DB9 F	0.5	7.39	6.65	5.99

VGA Monitor Cables

- Connects video card to VGA monitor
- IBM PC/XT and higher compatibles
- HDDB15 male to male



Part No.	Description	1	10	100
66173CD	6' monitor cable	\$6.49	\$5.89	\$5.29
148523CD	10' monitor cable	6.95	6.25	5.59

9-Pin Monitor Cable

- For monochrome, RGB, EGA and multisync monitors
- Connects video card to monitor
- IBM PC/XT and higher compatibles



Part No.	Description	1	10	100
66157CD	6' DB9 M-M	\$4.45	\$3.95	\$3.55

VGA Monitor Extension Cables

- Extends VGA monitor cable; HDDB15 male-to-female
- IBM PC/XT and higher compatibles



134041CD: • HDDB15 female with hex nuts and HDDB15 male with thumbscrews

66165CD/148531CD/220661CD:
• Thumbscrews on each end

Part No.	Description	1	10	100
134041CD	6' screws/hex nuts	\$4.49	\$3.95	\$3.49
220661CD	5' thumbscrews	4.39	3.89	3.35
66165CD	6' thumbscrews	6.59	5.95	5.35
148531CD	10' thumbscrews	7.49	6.79	5.99

DA15 Extension Cables

- Molded connectors
- Straight through
- Thumbscrews
- Color: gray



Part No.	Description	Length	1	10	100
181286CD	DA15 M-M	6'	\$5.49	\$4.95	\$4.45
181358CD	DA15 M-F	6'	5.49	4.95	4.45

DB25 Serial Modem Cable

- Molded and fully shielded DB25 M-F
- 9 pins wired straight through: pins 1-8 and 20 (metal shell)



Part No.	Description	1	10	100
53858CD	6' M-F	\$4.49	\$3.85	\$2.89

DB25-to-Centronics Parallel Printer Cables

- Molded and fully shielded DB25 male and 36-pin Centronics male connectors
- IBM PC/XT and higher compatibles



Part No.	Description	Wt. (lbs.)	1	10	100
28716CD	6' straight	0.4	\$4.69	\$4.25	\$3.85
223845CD	6' straight	0.6	11.95	10.95	10.95
123781CD	10' straight	0.6	5.95	5.09	3.79
164777CD	10' right angle*	0.7	5.49	4.69	3.55
28708CD	15' straight	0.8	5.95	5.09	3.79
101899CD	25' straight	1.1	5.95	5.09	3.79
184786CD	50' straight	2.1	3.95	3.55	3.19

* Centronics right angle

36-Pin Centronics Printer Extension Cables

25 Conductors

- Molded and fully shielded Centronics 36-pin male and female connectors
- Use to lengthen standard printer cables or for switch box applications
- Weight: 1.0 lb.

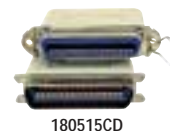

Part No.	Description	# of Conductors	1	10	100
40791CD	10' M-M	25	\$0.29	\$0.25	\$0.19
180515CD	6' M-F	25	.35	.31	.29

37-Pin Straight Through Cable Adapters

- Molded connectors
- Weight: 0.9 lbs.
- Color: gray



Part No.	Description	1	10	100
180611CD	6' DC37 M-M	\$6.95	\$6.29	\$5.65
181294CD	6' DC37 M-F	5.95	5.49	4.95

DB9 Extension Cables

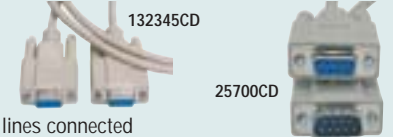

- All lines connected straight through
- 132345CD/196365CD:**
• DB9 female to DB9 female cable with thumbscrews
- 25700CD/148515CD/199638CD:**
• DB9 male to DB9 female cable with thumbscrews
- 181665CD:** • DB9 male to DB9 male cable

Part No.	Description	1	10	100	1000
132345CD	6' F-F	\$4.95	\$4.49	\$3.95	\$3.49
199638CD	6' M-F (black)	4.49	3.95	3.49	2.95
25700CD	6' M-F	4.95	4.49	3.95	3.49
196365CD	10' F-F	6.95	6.25	5.59	4.95
148515CD	10' M-F	7.49	6.79	5.99	4.95
181665CD	10' M-M	6.95	6.25	5.59	4.95

9-Pin Test Cable

- DB9 M to DB9 F (6')
- Pin outs: 1-3, 2-2, 4-5



Part No.	Description	1	10	100
162915CD	DB9 male to DB9 female	\$3.49	\$2.99	\$2.25

DB9-to-DB25 AT-Adapter Serial Cables

- For DB9 serial ports which need to be converted to DB25 serial
- AT and compatibles
- Molded DB9 female to DB25 male connectors



Part No.	Description	1	10	100
109583CD	1' serial, beige	\$4.35	\$3.95	\$3.49
189333CD	3' serial, beige	3.95	3.39	2.55
31721CD	6' serial, beige	3.89	3.55	3.15
191361CD	6' serial, gray	4.39	3.99	3.15
155521CD	10' serial, beige	4.49	3.85	2.89
207790CD	4' serial, beige	3.95	3.59	3.25

DB25 Extension Cables

- All lines connected straight through
- Use to lengthen your standard serial cable or for switch box applications
- Thumbscrews to secure connectors
- Color: gray; except P/Ns 174001CD/175290CD: black*



Part No.	Description	Wt. (lbs.)	1	10	100	1000
174001CD	3' M-M*	0.6	\$4.79	\$4.35	\$3.89	\$3.49
65787CD	6' M-M	0.5	6.49	5.89	5.29	4.89
39538CD	10' M-M	0.7	6.95	6.29	5.05	3.69
179979CD	15' M-M	1.2	6.95	6.29	5.05	3.65
67070CD	25' M-M	1.4	10.95	9.95	8.95	7.95
180435CD	50' M-M	3.6	14.95	13.49	11.95	9.95
175329CD	1' M-F	0.3	3.39	3.05	2.75	2.45
164291CD	3' M-F	0.4	4.29	3.89	3.09	2.35
175290CD	3' M-F*	0.4	2.95	2.69	2.25	1.59
163133CD	5' M-F	0.6	5.29	4.75	4.29	3.85
67256CD	6' M-F	0.6	6.45	5.79	5.25	4.69
39511CD	10' M-F	0.7	6.95	6.29	5.05	3.69
177279CD	15' M-F	1.0	9.49	8.55	6.85	4.99
101995CD	25' M-F	1.4	11.95	10.79	8.65	6.35
181201CD	50' M-F	3.2	17.95	14.39	10.79	7.55
224266CD	6' F-F	0.7	4.95	3.95	2.95	2.09
181331CD	10' F-F	0.9	6.69	5.55	4.15	2.89

30-Day Money-Back Guarantee

If you're not completely satisfied, we'll take it back!

Details on page 217.

2-Way & 4-Way Monitor/Keyboard/Mouse-to-PC Switch Boxes

HDDB15/5-Pin DIN/DB9M

- Allows 2 or 4 users to share one PC system
- Internal diodes maintain keyboard in powered state when switching between systems
- Each user may need 2 or 4 sets of the following cables: P/N 66173CD, DB15HD M-M for monitor; P/N 114913CD, 5-pin DIN M-M for keyboard; P/N 132345CD, DB9 F-F for serial mouse (cables, pgs 184 - 185)
- Size: 7.5"L x 5.3"W x 2.8"H



Part No.	Description	Wt. (lbs.)	1	10
132249CD	2-user switch box	1.6	\$17.95	\$15.95
134017CD	4-user switch box	2.3	21.95	19.95

Keyboard/Monitor-to-PC Switch Box

HDDB15/5-Pin DIN Female

- 2-way switch box
- For 2 PCs connected to 1 keyboard and 1 monitor – diodes maintain keyboard in powered state
- Size: 6.0"L x 4.0"W x 2.3"H
- Weight: 1.3 lbs.



Part No.	Description	1	10
114155CD	2 computers	\$14.95	\$13.49

Keyboard/Monitor-to-PC Switch Box

HDDB15/6-Pin Mini DIN Female

- Connects 2 monitors and 2 keyboards to a PC
- Size: 6.0"L x 4.5"W x 2.6"H
- Weight: 1.3 lbs.



Part No.	Description	1	10
79177CD	2-way switch box	\$16.95	\$15.25

Serial Port-to-PC Switch Boxes

DB9 Female

- Connects 2 or 4 serial ports to a PC
- 79126CD: 2-serial port switch box
- Size: 6.0"L x 4.8"W x 2.5"H
- Weight: 1.2 lbs.
- 183417CD: 4-serial port switch box
- Size: 6.1"L x 4.0"W x 2.2"H
- Weight: 1.3 lbs.



Part No.	Description	1	10
79126CD	2-serial port switch box	\$9.95	\$8.95
183417CD	4-serial port switch box	19.95	17.95

Network Devices-to-Server Switch Box

RJ45 8P8C Female

- Connects network devices to 4 servers
- 5 RJ45 8P8C females
- Size: 8.0"L x 6.1"W x 2.2"H
- Weight: 2.0 lbs.



Part No.	Description	1	10
180099CD	4-server RJ45 switch box	\$14.95	\$13.49

Fax/Modem/Telephone-to-PC

RJ11 6P6C Female

- Connects fax, modem, or telephone to 2 or 4 PCs
- 79142CD: 2-PC switch box
- Size: 6.0"L x 4.8"W x 2.5"H
- Weight: 1.2 lbs.
- 180161CD: 4-PC switch box
- Size: 8.0"L x 6.0"W x 2.2"H
- Weight: 2.0 lbs.



Part No.	Description	1	10
79142CD	2-PC RJ11 switch box	\$9.95	\$8.95
180161CD	4-PC RJ11 switch box	13.95	12.59

Parallel Printer-to-PC Switch Boxes

DB25 Female

- Connects 2 or 4 PCs to one printer
- 20095CD: 2-PC switch box
- Size: 6.0"L x 5.8"W x 2.3"H
- Weight: 1.3 lbs.
- 155512CD: 2-PC switch box
- Size: 7.2"L x 4.9"W x 2.5"H
- Weight: 2.3 lbs.
- Includes: DB25 M-M cable
- 20124CD: 4-PC switch box
- Size: 6.0"L x 4.0"W x 2.4"H
- Weight: 1.5 lbs.

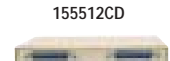
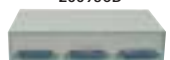

Part No.	Description	1	10
20095CD	2 PC switch box	\$8.95	\$7.95
155512CD	2 PC switch box	6.49	5.54
20124CD	4 PC switch box	14.95	13.49

Don't worry about backorders.
Over 99% of our products are in stock!

We'll Send It Today!

Just place your order by 6PM EST for same business day shipment.

Monitor/Mouse/Keyboard Cables

- 6' or 32'
- HDDB15 male/female for monitor, 5-pin DIN male/female for keyboard, and DB9 male/female for mouse



Part No.	Description	Wt. (lbs.)	1	10
141284CD	6' cable	1.6	\$22.95	\$19.95
141276CD	32' cable	4.8	39.95	35.95

Switch Box Adapter Cables

- 177261CD: Male to male non-coiled cable for P/N 79177 switch box, left
- 114913CD: Male to male coiled cable for P/N 114155CD switch boxes, left
- 174772CD: Male to male
- 174908CD/205655CD: Male to male non-coiled
- 112627CD: Male to male non-coiled cable for P/N 79177 switch box, left

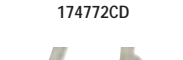

Part No.	Description	Length	1	10	50
177261CD	6-pin mini DIN	2' (gray)	\$2.95	\$2.55	\$1.89
114913CD	5-pin DIN	5' (gray)	4.95	4.49	3.95
174772CD	6-pin mini DIN	6' (black)	4.95	4.25	3.19
174908CD	6-pin mini DIN	6' (gray)	5.75	5.15	4.65
112627CD	6-pin mini DIN	10' (beige)	7.95	7.25	6.49
205655CD	6-pin mini DIN	25' (beige)	8.95	7.95	6.95

PC/XT/AT & PS/2 Keyboard Extension Cables

- Color: beige
- 22234CD/114981CD/112045CD/169826CD:
- 5-pin DIN male-to-female
- 28548CD/111053CD:
- 6-pin mini DIN female-to-male



Part No.	Description	1	10	100
22234CD	PC/XT/AT 5' coiled	\$1.05	\$0.95	\$0.85
114981CD	PC/XT/AT 6' non-coiled	3.85	3.45	3.09
169826CD	PC/XT/AT 10' coiled	.99	.89	.79
112045CD	PC/XT/AT 10' non-coiled	3.95	3.39	2.55
28548CD	PS/2 6' non-coiled	4.35	3.89	3.49
111053CD	PS/2 10' non-coiled	5.49	4.99	4.39

AT-to-PS/2 and PS/2-to-AT Keyboard Adapter Cables

- 28003CD:
- Connects AT-type keyboards to PS/2
- 5-pin F DIN to 6-pin M mini DIN
- 85500CD:
- Connects PS/2 keyboard to AT
- 6-pin female mini DIN to 5-pin male DIN connectors



Part No.	Length	Color	Wt. (lbs.)	1	10	100
28003CD	6.5"	Beige	0.6	\$3.95	\$3.49	\$3.15
85500CD	11.3"	Beige	0.8	5.39	4.85	4.39

Computer Accessories

- Printers page 174
- Monitors page 175
- Mice page 176



ATEN SVGA Monitor Splitters

Duplicate a video signal from one source to monitors up to 210 feet away.

- Suitable for SVGA, VGA and multisync monitors
- 176866CD: 2-channel**
- 1 HDB15 male connector from PC to box; 2 HDB15 female connectors from box to monitors
- Size: 6.6"L x 3.3"W x 1.1"H • Weight: 1.4 lbs.
- 133866CD: 4-channel**
- Slide switch for video signal gain control
- Daisy chainable • One-year warranty
- Size: 8.8"L x 6.0"W x 1.9"H • Weight: 3.6 lbs.



176866CD



133866CD

Includes: Power adapter and manual

Part No.	Description	1	10
176866CD	2-channel monitor splitter	\$49.95	\$44.95
133866CD	4-channel monitor splitter.....	68.95	61.95

ATEN K/V/M Switch Boxes for up to 4 Computers

- Selects any computer by hot keys or switch
- Serial and PS/2 mouse and keyboard emulation for automatic PC boot up
- Three stage cascadable for accessing more computers
- Supports SVGA, VGA and Multisync monitors
- Keyboard LED status recorded and restored while switching among computers
- Auto scan for monitoring PC periodically
- One-year warranty
- Size (149382CD): 9.0"L x 6.0"W x 2.0"H (149391CD): 10.0"L x 7.0"W x 3.0"H



149382CD (front)

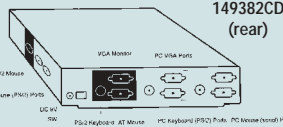

149382CD (rear)



149391CD (front)

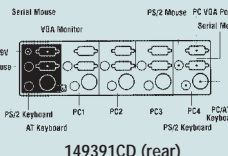

149391CD (rear)

Includes: Manual and power supply (9VDC @ 600mA)

Part No.	Description	Wt. (lbs.)	1	10
149382CD	2 computers	4.0	\$149.95	\$129.95
149391CD	4 computers	7.1	229.95	209.95

2-Port K/V/M Switch Box

This two port K/V/M switch box can access two computers from one keyboard, mouse, and monitor. No interface card or software to configure. Operation is as simple as pushing a button on the front panel and entering hot-key commands.



- Supports Microsoft® IntelliMouse, Logitech Net Mouse, etc.
- Supports operating systems DOS, Win 3.x, Win95/98/98SE/2000/ME, WinNT, Netware, Unix, Linux
- High VGA resolution
- Keyboard and mouse pluggable at anytime
- Hot-key function allows easy computer access
- Audible sound for switching port confirmation
- Port and console connectors: female PS/2 keyboard and mouse, female HDB15 for video
- Size: 4.3"L x 3.0"W x 1.2"H

Part No.	Description	1	10
216063CD	2 port switch box	\$69.95	\$62.95
204062CD	6' PS/2 cable	16.95	15.29

Monitor/Mouse/Keyboard Cables

- 6' or 32'
- HDB15 male/female for monitor, 5-pin DIN male/female for keyboard, and DB9 male/female for mouse



141284CD

Part No.	Description	Wt. (lbs.)	1	10
141284CD	6' cable	1.6	\$22.95	\$19.95
141276CD	32' cable	4.8	39.95	35.95

We'll match the advertised price of any like product.

Jameco's Low-Price Guarantee

It's that simple!

Printer Sharing

Bidirectional Non-Buffered Serial-to-Parallel Converter

- Bidirectional conversion of parallel and serial signals
- Serial interface: hardware handshake RTS/CTS, software handshake XON/XOFF; DCE/DTE selectable; parity: odd, even, or no parity; data bits: 7, 8
- Connectors: one DB25 female and one Centronics 36-pin male
- Baud rate: 300 to 38,400bps • Stop bits: 1 or 2
- Size: 4.0"L x 2.5"W x 1.0"H
- Weight: 0.8 lbs. • One-year warranty



ATEN

Includes: AC adapter (9VAC @ 200mA) and manual

Part No.	Description	1	10	25
116935CD	Bi-converter	\$49.95	\$44.95	\$39.95

Printer Port Extender

- 4-wire phone line transfer of parallel printer data
- Maximum distance: 1300' (396 meters)
- Non-powered
- Transmitter & receiver – DB25M and RJ11 (6P4C) jack
- Maximum data transfer speed: 21kb/sec.
- Size (transmitter and receiver): 3.0"L x 1.9"W x 0.9"H



SALE

Includes: 25 ft. RJ11 cable

Part No.	Description	1	10
183337CD	Printer port (DB25M)	\$18.95	\$16.95

4 & 2-Port Auto Printer Switches

- Connects up to 4 PCs to 1 printer or 4 printers to 1 PC
- Non-powered
- Compact size
- Auto form-feed selectable
- Transparent to user
- 177421CD:** bidirectional; 3.5" software included; 5 DB25 female connectors
- 177412CD:** 5 DB25 female connectors
- 177404CD:** 3 DB25 female connectors



177421CD



177404CD

SALE

Part No.	Description	1	10	25
177421CD	1 to 4 or 4 to 1	\$7.75	\$6.96	\$6.26
177412CD	4 to 1 printer	3.49	3.15	2.89
177404CD	2 to 1 printer	2.15	1.95	1.75

As Your Needs Change, Jameco Changes with You!

We're constantly updating our selection to make it the most appropriate for your needs. In this catalog you'll find new Components, Test Equipment, Tools, Category 6 cables, USB 2.0, Personal Security, Connectors, Transformers and Medical Power Supplies.



19" Rack Mount Enclosures

Perfect for equipment setup in home, studio or laboratory.

- Ventilation holes on all sides
- Front and back panels are steel w/ aluminum, pre-punched face plates
- Top, bottom, sides durable 0.035" steel
- Front panel: 0.12" Thick • Black front panel
- All enclosures have handles except P/N 132812CD



Includes: Mounting screws

Part Number	Dimensions (In.)			Weight (lbs.)	Pricing	
	H1	H2	D		1	10
132812CD	1.73	1.25	9.75	6.2	\$39.95	\$35.99
132821CD	3.46	3.0	9.75	7.9	47.95	43.49
132839CD	3.46	2.88	11.75	9.1	53.95	48.59
132847CD	5.22	4.75	11.75	10.6	63.95	55.99
132855CD	5.22	4.75	13.50	11.8	73.95	66.95
132863CD	8.56	8.0	13.50	15.4	94.95	84.95

19" Industrial Chassis with PC-AT 300-Watt Power Supply

EIA RS-310C Compliant

- Back panel with 12 open slots
- Supports one 3.5" and two 5.25" external accessible bays and two 3.5" internal bays
- Use with 14-slot PC-BUS compatible backplane P/N 135061CD, above right
- Removable disk drive bay w/ shock resistant design
- Front 12VDC cooling fan with removable air filter screen and mesh
- Waterproof front panel
- Color: gray • Weight: 37 lbs.
- Size: 16.8"L x 16.9"W x 7.0"H



Includes: Mounting hardware

Part No.	Description	1	10
146851CD	19" chassis w/ 300W PS	\$295.95	\$269.35

19" Rack Mount Enclosure for 14" Monitor

- Clear glass front panel
- Hinged door for accessing monitor controls
- Color: gray
- Size: 19.0"W x 15.1"D x 14.0"H
- Weight: 30 lbs.

SALE



Part No.	Description	1	10
136021CD	Enclosure for 14" monitor ..	\$249.95	\$224.95

19" Rack Mount Drawer with Keyboard and Trackball

- Occupies a single unit (1U) rack space
- PS/2 connector for keyboard and trackball
- Color: gray
- Size: 19"W x 13"D x 2.8"H
- Weight: 18 lbs.



Includes: Wrist pads, module, PS/2 to 5-pin DIN and PS/2 to 9-pin adapters, and software

Part No.	Description	1	10
220644CD	Rack mount KB drawer	\$249.99	\$234.99

16-Slot ISA-PCI-PICMG Passive AT Backplane

- Ten 16-bit ISA slots, four 32-bit PCI slots and two 48-bit PICMG slots
- LED indicators for $\pm 5V/\pm 12V$
- Compatible with P/N 146851CD (below left)
- Size: 12.5"L x 10.0"W
- Weight: 1.9 lbs.



SALE

Part No.	Description	1	10
135061CD	Passive AT backplane	\$119.95	\$109.95

Cabinet Mounting Plate for 19" Cabinet

- Use as industrial chassis mounting plate for servers, PCs or patch panels
- Made of industrial grade steel and aluminum
- Size: 19.0"W x 15.8"D x 3.5"H • Color: beige



Part No.	Description	1	10
149500CD	Cabinet mount plate	\$39.95	\$35.95

Removable HD Rack and Insert

- For quick drive swapping
- Removable storage for 3.5" IDE drive
- Power LEDs
- Keylock for security



- **196040CD:**
• Size: 5.8"W x 8.5"D x 1.5"H
• Weight: 1.2 lbs.
- **196031CD:**
• Size: 4.1"W x 7.5"D x 1.6"H • Weight: 0.8 lbs.

Includes: Inner cable with IDE connector

Part No.	Description	1	10	25
196040CD	IDE rack w/ insert ..	\$27.95	\$20.95	\$14.69
196031CD	Insert for 196040	19.95	17.99	15.99

IDE Removable 5.25" Rack Kit for 3.5" Hard Drive w/ Fan

- Supports DMA 66 hard drive
- Removable storage for 3.5" hard drives
- LED for power and hard drive activity
- Retaining lock mechanism
- 12VDC @ 50mA fan
- Size: 5.9"W x 8.7"D x 1.6"H
- CFM rating: 5.6
- Weight: 1.3 lbs.



Includes: Mounting hardware

Part No.	Description	1	10	25
170608CD	Rack kit (IDE)	\$29.95	\$26.95	\$23.95

19" Cable Management Racks

Make your cable looms neat and organized with our 2 unit cable management rack. Simply slip in the cable between spaces and route them to their destinations.



SALE

For Rack Mount Patch Panels See Page 191

Part No.	Description	1	10
208776CD	Ducting type cable holder	\$19.95	\$17.99
209031CD	C clamp type cable holder	17.89	16.89

Relay Rack & Rack Panels

Rack:

- Black powder coat finish
- 10-32 threaded holes
- Used with 19" wide panels
- 16 gauge CRS base • Size: 84"H
- 1/8" aluminum side rails
- Size (at base): 19.8"W x 15.3"D x 84"H



133751CD

19" Wide Panel:

- 10-gauge black aluminum
- Size: 1.75"H

133276CD

Part No.	Description	Wt. (lbs.)	1	10
133751CD	Relay rack	21.8	\$179.95	\$161.95
133276CD	Rack panel	0.4	9.45	8.49

Rack Mount Card Cage

- For 19" rack mounts
- 24 slots
- Weight: 6.3 lbs.
- Fits card size: 6.5"L x 5.5"W
- Size: 6.5"L x 17.3"W x 6.1"D

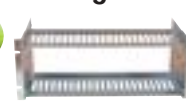

Part No.	Description	1	10	25
172099CD	Rackmount card cage	\$7.95	\$6.79	\$5.09

Front Panel Access Ports

Tired of crawling under your desk or standing on your head to plug something into your computer? With these 3.5" front panel access ports, you can customize your PC's to have access to the rear panel USB, IEEE 1394, audio, and serial ports. Now you can enjoy the easy upfront access to all your most used ports without moving the PC.



Tower not included

- **208004CD:** 2 USB; 1 IEEE 1394; Line-In; Line-Out; RS232 (9-pin male)
- **213532CD:** 4 USB; Line-In; Line-Out
- **213541CD:** 2 USB; 1 IEEE 1394; Line-In; Line-Out

Part No.	Description	1	10
208004CD	Front panel port	\$34.95	\$32.45
213532CD	Front panel port	18.95	16.95
213541CD	Front panel port	18.95	16.95

PCMCIA Card Drive For Desktop PC

PCMCIA drives are commonly found on laptops and power notebooks. Now you can have a PCMCIA drive on your desktop PC. Supports SRAM cards, FLASH cards, LAN cards and FAX/MODEM cards.



Tower not included

- Jumper selectable for 4 drives
- Supports DOS 5.0 or later, Windows 3.1 or later
- Supports Type I/II/III PCMCIA cards

System requirements: IBM PC compatible, 1M free hard disk space, available ISA slot (16-bit), 3.5" bay, DOS 5.0 or later, Windows® 3.1 or later

Includes: Manual, cable and 3.5" diskette drivers

Part No.	Description	1	10
210999CD	PCMCIA drive	\$59.95	\$53.95

Corporate Customers

Opening an account is easy!!
Call 1-800-831-4242 for details today

Power Strip Saver Single Outlet

Get full use of your power strips and UPS outlets with our high quality power strip outlet saver, you can use all the outlets on your surge suppressors, UPS, and outlet strips. Just plug a bulky power adapter into this cable and free up your other outlets.



Before
Two Outlets
Blocked



After
Every Outlet
is Usable



Part No.	Description	Length	Cord Type	1	10	100
199777CD	AC Power cord (black)	1'	SVT	\$1.69	\$1.55	\$1.39
208338CD	AC Power cord (beige)	1'	SVT	1.69	1.45	1.09

"Y" Power Strip Saver Double Outlet

Get full use of your power strips and UPS outlets with the "Y" power strip saver. Plug those bulky adapters into these cables and plug the cables into the power strip. Need the extra adapter to be plugged into the power strip? Use the "Y" power strip saver to add an extra adapter.



Part No.	Description	1	10	100
208346CD	Power strip saver	\$2.89	\$2.65	\$2.35

6-Outlet Surge Protector

- Input: dual 3-prong input plug
- Surge energy capability: 110 joules
- Surge voltage/current capability: 6000V/4500 to 6000A
- Response time: under 1 ns
- Clamping voltage: 400 volts
- Rating: 125VAC - 15 Amps



Part No.	Description	1	10	25
195848CD	6-outlet protector	\$3.09	\$2.79	\$2.55

6-Outlet Surge Protector

- Metal
- Max. spike current: 4500 amps, 50 joules
- 3-prong, 4' power cord
- Size: 12.3"L x 2.4"W x 1.3"H



Part No.	Description	Wt. (lbs.)	1	10	100
20175CD	Metal pwr strip	1.5 ..	\$9.85	\$8.85	\$7.85

6-Outlet Surge Protector

- Standard 6-outlet surge suppressor
- Heavy-duty power cord (14AWG x 3)
- RESET/OFF switch with built-in 15A circuit breaker
- Clamping voltage: 400V
- Maximum surge dissipation: 900 joules
- Maximum surge voltage: 6500V
- Maximum spike current: 4500A • Weight: 0.9 lbs.



Part No.	Description	1	10	100	
216485CD	Surge suppressor	\$6.95	\$6.25	\$5.59

Compact Surge Protector For Notebook Computers

- Single 3-prong receptacle outlet; and telephone modem protection
- 3-prong wall mount type
- 210 joule rating
- Surge LED indicator
- RFI noise blocker
- Size: 2.3"W x 1.3"D x 3.3"H



Includes: 4' RJ11 cord

Part No.	Description	1	10	25
206279CD	Single outlet protector	\$4.25	\$3.85	\$3.55

APC Automatic Voltage Regulator

LR Series

- Overvoltage and brownout correction LEDs
- Maximum line current: 8A
- 320 joules
- EMI/RFI noise rejection: 50dB
- Size: 6.8"W x 8.4"D x 5.0"H
- \$25,000 lifetime equipment protection policy



Part No.	APC No.	Watts	Wt. (lbs.)	1	10
191302CD	LR600	600	12.5	\$69.95	\$64.25
191290CD	LR1250	1250	17.8	114.95	104.95

APC Professional Surge Arrest PRO8 Series

- 8 outlets with RJ11 modem/fax/DSL protection
- 320 joules
- Peak current normal and common mode: 13kAmps
- EMI/RFI noise rejection: 60dB
- \$10,000 lifetime equipment protection policy
- PRO8T2: 8 outlet with RJ11 modem/fax/DSL protection; PRO8TV: 8 outlet w/ coaxial cable and RJ11 modem/fax/DSL protection
- Size: 8.0"W x 5.8"D x 1.8"H



Includes: 5' telephone cable

Part No.	APC No.	Wt. (lbs.)	1	10
191839CD	PRO8T2	2.5	\$26.95	\$24.59
191791CD	PRO8TV	2.5	31.95	28.79

Personal Surge Arrest



Part No.	APC No.	Weight (lbs.)	1	10
191273CD	PER3C	1.3	\$16.65	\$15.15
191265CD	PER7	2.1	16.49	14.85
191855CD	PER7T	2.3	18.99	17.29

APC Power Manager-POW6T

- 6 outlets
- 480 joules
- Peak current normal mode: 13kAmps
- Peak current common mode: 26kAmps
- UL1449 TVSS rating: 330V
- \$25,000 lifetime equipment protection policy
- Size: 12.5"W x 14.6"D x 1.7"H



Part No.	APC No.	Weight (lbs.)	1	10
191804CD	POW6TWH	6.0	\$55.75	\$50.69

APC Notebook Surge Protector-PNOTEPRO

- PNOTEPRO: C8 type connector (2-prong); PNOTEPRO3: C6 type connector (3-prong)
- Surge energy rating: PNOTEPRO - 120 joules; PNOTEPRO3 - 180 joules
- Input connection type: IEC 320
- RJ11 telephone protection
- Five-year standard warranty with \$5,000 equipment protection policy
- Size: 1.3"W x 4.8"D x 1.5"H



Includes: Manual, 5' telephone cable and Velcro cord

Part No.	APC No.	1	10
191821CD	PNOTEPRO	\$22.45	\$20.45
191812CD	PNOTEPRO3	22.45	20.45

See the yellow and green highlighted items.

Jameco Special Values

Sale details are on page 4.



TRIPP-LITE isobar®

Surge Protectors



The world's best known, most advanced surge protectors provide total protection against surges, spikes and line noise.

- Up to \$50,000 Ultimate Lifetime Insurance covers Isobar and connected equipment against surge damage for life!
- Diagnostic indicators on Ultra versions alert you to improper outlet wiring, loss of AC power, and damage to protection circuitry
- "Cascade Circuitry" allows you to chose increased noise protection level for your most sensitive equipment
- UL 1449 and 1283 listed • Lifetime warranty
- IsoTel model has dual RJ11 jacks for complete modem/fax surge protection
- 2, 4 & 6-outlet protectors: 6' cord; 8 and 12-outlet protectors: 12' cord

ULTIMATE LIFETIME INSURANCE



Isobar Premium 19" Rack Mount Surge Protector

Part No.	Product No.	Joules	Description	Wt. (lbs.)	1	10
139686CD	IBAR12RM	750	12 outlet, 2 isolated filters	4.7 ...	\$119.95	\$107.99

Isobar Premium Surge Protectors

18981CD	ISOBAR 4	2200	4 outlet, 2 isolated filters	2.4	\$49.95	\$44.95
74544CD	ISOBAR 6	2350	6 outlet, 3 isolated filters	2.7	\$4.95	\$4.95

Isobar Ultra Premium Surge Protector

19001CD	ISOBAR 8U	2350	8 outlet, 4 isolated filters	3.5	\$69.95	\$62.95
---------	-----------	------	------------------------------	-----------	---------	---------

Isotel AC/Phone Line Surge Protector

185113CD	ISOTEL 4U	2700	4 outlet, 2 isolated filters	2.7	\$39.95	\$35.95
----------	-----------	------	------------------------------	-----------	---------	---------



Standard Surge Protectors



SALE



Economical and effective spike and noise suppression with diagnostic LEDs.

168954CD: \$5,000 Ultimate Lifetime Insurance
124337CD/32045CD: \$35,000 Ultimate Lifetime Insurance

Part No.	Product No.	Joules	Description	Wt. (lbs.)	1	10
168954CD	Striker 7	480	Up to 27,000 amp spikes	1.2	\$8.95	\$8.49
124337CD	Super 7	1402	Up to 42,000 amp spikes	1.6	17.95	15.95
32045CD	Super 8	1200	Up to 54,500 amp spikes	1.7	25.95	24.95



Battery-Backed UPS Systems

- Protects your PC, fax/modem and all peripherals against all types of power problems
- Automatic system shutdown with free PowerAlert software for 500VA and 700VA
- Up to \$25,000 Ultimate Lifetime Insurance for connected equipment • Up to 45 minutes runtime
- 6-outlets, RJ11 for fax/modem protection

SALE



Part No.	Product No.	Description	Agency	Wt. (lbs.)	1	10
185130CD	IO500	500VA, 6 outlets	UL/CSA	16.0	\$119.95	\$114.95
185148CD	IO700	700VA, 6 outlets	UL/CSA	20.0	188.95	169.95

Surge Suppressor Stops Crawling and Toe Cramp

Use our remote control surge suppressor and stop crawling under your desk or flipping on your equipment power with your toe. Just place the small control strip anywhere easily at hand, up to 6 feet away from the base unit. Attach the remote to the side of your monitor with the enclosed adhesive strips if you like to keep you desktop clear. Then power up 4 plugs, or turn off specific outlets with a touch of a button. One play stays alive continuously. The extra long power cord lets you place the base unit up to 9 feet from your wall outlet.



Free \$25,000 Equipment Protection Policy

Kensington is so sure their product will protect both your equipment and phones that they back up with The Kensington Limited Lifetime Warranty that protects your equipment for up to \$25,000 against damage (see package for details).

- Energy rating: 420 joules (140 each line)
- Clamping voltage: 330V; telephone protection @ 465V
- EMI/RFI filtering: attenuation up to 40dB with frequency range of 600kHz – 26MHz
- Size: (outlet strip) 12.5"L x 3.0"W x 3.5"H; (remote) 6.5"L x 2.0"W x 1.0"H
- Current peak: 39,000A
- 5 outlets/3 switches
- Weight: 2.0 lbs.
- 15A circuit breaker
- Failure indicator light
- UL listed

NEW

Special Purchase Limited Quantity Only \$39.95 Sug. Retail \$169.95

Part No.	Description	1	5
211203CD	MasterPiece Plus Remote	\$39.95	\$35.95

POWERWARE 300-VA UPS System

With Dual Outlet

- Protects against blackouts and brownouts
- Battery charging: less than 6 hours to 90% usable capacity
- Battery backup time: 5–10 mins. @ full load; 10–20 mins. with partial load
- Input voltage: 120VAC @ 60Hz
- Output voltage: 120VAC
- Output current: 2.5 amps (full load)
- Size: 3.4"W x 5.8"D x 13.2"H
- Weight: 12.4 lbs.



Part No.	Product No.	Description	1	10
179961CD	PRB300A	300-VA UPS system	\$59.95	\$53.95

For our huge selection of Wall Transformers (Adapters) and Table-top Power Supplies see pages 53 - 58.



Computer

Phone 1-800-831-4242

Online www.Jameco.com

Fax 1-800-237-6948

Order Anytime 24x7x365



Single-Line Telephone Filter

In-line Z-BLOCKER® filter blocks interference between DSL /HPN, voice and RF from cordless phones. Plugs directly into any standard phone jack and works with any single line phone, fax or dial-up modem.



Part No.	Description	1	10	25
196429CD	Telephone filter	\$4.59	\$4.15	\$3.79

Black Magic Telephone Ringing Generator

Switching inverter that produces low-frequency alternating current to signal telecom ringers or equivalents.

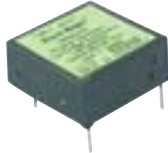

- Frequency: 20Hz
- Series resistor: 300Ω
- Nominal output voltage: 86 Vrms
- No reverse polarity protection

Part No.	Product No.	1	10	25
145816CD	LBMR12	\$26.95	\$24.49	\$21.95

RJ11/RJ45 Retractable Cables

These auto-reel retractable cables are compact and convenient solutions for the mobile professional.



- 208362CD: RJ11 type
- For telephone and modem applications
 - Cord length: 9'6"
 - Includes: inline coupler

- 208371CD: RJ45 type, CAT 5e
- For telephone, modem and networking applications
 - Cord length: 6'11"

Includes: RJ45 right angle adapter and RJ45 to telephone outlet adapter

Part No.	Description	1	10
208362CD	RJ11 cable	\$8.95	\$7.95
208371CD	RJ45 cable	16.35	14.85

QUIKLINK Automatic Telephone Ring Down Unit

- Applications: elevator and door entry phones; in-office and off-premise emergency hotlines; tie lines between phones, PABX and Key systems; CO line simulators for sales demonstrations; testing rings, answering, and signal path functions in telecom repairs, installation and production
- Ringing power: 70V @ 20Hz modified square wave
- Power input: 12VAC @ 700mA (max.)
- Line feed type: two wire unbalanced
- Max. loop resistance: 600Ω
- Termination: 4-40 screws
- LED hook status indicator; ringing cadence: continuous/1 second on 1 sec. off/2 sec. on 2 sec. off/2 sec. on 4 sec. off; additional power input: 20-28VDC @ 300mA max.; RJ11 terminations



Part No.	Dimensions	1	10
179936CD	4.2"L x 2.5"W x 0.5"H	\$99.95	\$89.95

AT&T Fax Switcher

- Features automatic ring reduction, answering system transfer and transfer timer, extension in use detection and calling tone detection, dial pulse/ rotary transfer, unanswered call transfer, reverse modem detection, remote call alert, line interrupt protection, calling tone detection
- System capacity: line-in, answering machine, phone, modem/fax connection
- Size: 4.9"L x 5.1"W x 1.4"H
- Weight: 1.8 lbs.



Includes: 12VAC @ 830mA power supply, 6' 11" telephone cable, and manual

Part No.	Product No.	Description	1	10
152004CD	ATT200A	Fax switch	\$24.95	\$22.49

External 56kbps Fax/Modem With Digital Answering Machine

- Digital telephone answering machine with voice mail system
- RS-232 (DB9 female) interface
- Modem line speed: 300-56000bps
- Standard compatibility: ITU-T V.92, V.90, V.34, V.32, V.32bis, V.23, V.22bis, V.21 and Bell 103, 212A
- Error correction: ITU-T V.42, MNP2-4
- Data compression: ITU-T 1.42bis, MNP5
- Flow control: RTS/CTS, XON/XOFF
- Comment set: TIA/EIA 602 "AT" command set
- Fax/Modem line speed: 2400-14400bps
- Standard compatibility: ITU-T V.17, V.27 ter, V.29
- Command set: Class 1, 1.0, 2 and associated AT command sets
- Size: 6.3"L x 4.0"W x 1.3"H



System requirements: Pentium® or PC compatible with 16MB of memory, available RS-232 slot; Windows® 9x/ME/NT4.0/2000/XP

Includes: RS-232 cable (DB25/DB9 female to DB9 male); phone cord, 9VAC@1A power supply, CD-ROM drivers and manual

Part No.	Description	1	10
216493CD	Serial modem (Rockwell)	\$49.95	\$44.95

Short Haul Modem

- Up to 38,400 baud
- Will communicate over 6.3 miles of cable
- No external power required
- DCE/DTE selectable
- Xon-Xoff or hardware handshaking
- RS-232 interface (DB25 female)



Part No.	Description	1	10	25
116581CD	Short haul modem	\$29.95	\$26.95	\$23.95

30-Day Money-Back Guarantee

See page 191 for Additional Hubs.

PHOEBE Networking

Personal Fast Ethernet Switch Hubs

- Eliminate bottlenecks and improve your home or small business network with true 100Mbps connection from JAMECO's choice as the best performance/value combination in networking - PHOEBE.
- IEEE 802.3 (10Base-T)/802.3U (100Base-TX) compliant
 - Store and forward method
- Auto MDI/MDIX, auto negotiation RJ45 ports
- Packet forwarding rate: 10Base-T - 14880pps to 10Mbps; 100Base-TX - 14880pps to 100Mbps
- 8k media access control (MAC) addresses
- Buffer memory size: 256k bytes RAM
- LED indicator for power and link activity



Includes: 7.5VDC @ 1A power supply, installation guide and mounting hardware

Part No.	Description	Size (LxWxH)	1	10
220863CD	5-port	4.9" x 2.9" x 1.2"	\$29.95	\$28.45
215642CD	8-port	6.7" x 3.9" x 1.2"	49.95	44.95

Wireless LAN Network

- Wireless networking provides students, workers & laptop users seamless roaming connectivity to your network or cable modem. PHOEBE 802.11B wireless products are perfect for small businesses, schools and for the home & will boost productivity while saving you the cost and frustration of installing cables throughout your building or home. Simply plug and play and you have a connection to your network in minutes. Jameco has reviewed a lot of networking products and companies over the last 12 months and has chosen PHOEBE Micro's products because they offer the best value, performance and quality. The wireless access point unit (220652CD) bridges wired and wireless segments of the network. The wireless USB LAN adapter (215618CD) can be used to extend your existing network to remote sites in your building.
- DSSS (direct sequence spread spectrum) provides superior noise immunity to broadband interference
 - 11 channels • 64/128bits WEP encryption • Freq. bandwidth: 2.4 - 2.4835GHz • IEEE802.11B standard



220652CD	215600CD	215618CD
Transmission power: 18dBm Access point, access point client & wireless bridge operation mode	5MHz Channel spacing PCMCIA Type II; built in 3D antenna Indoor range: up to 150' Outdoor range: up to 900'	Channel spacing: 5MHz Interface: USB1.1 (client) Indoor range: up to 270' Outdoor range: up to 900'

Part No.	Description	Receiver Sensitivity	1	10
220652CD	Wireless access point 11Mbps	-82dBm	\$97.95	\$91.95
215600CD	PCMCIA wireless network card	-80dBm	52.95	49.95
215618CD	Wireless USB adapter	-80dBm	59.95	54.95

226-Piece Network Connector Kit

Every connector needed by a network field technician to repair a network.



SALE

• Size: 10.5"L x 7.0"W x 1.5"H • Weight: 2.5 lbs.
This kit includes:

Quantity	Connector Type
50 pieces (each)	RJ11 solid flat cable (6P4C) RJ11 solid flat cable (4P4C)
25 pieces (each)	RJ11 solid round cable (6P4C) RJ45 solid round cable (8P8C) RJ45 solid flat cable (8P8C)
20 pieces	RJ45 protection caps (assorted colors)
5 (each)	BNC for RG58/U cable BNC for RG59/62/U cable BNC for RG174 cable BNC 50Ω terminator BNC Female-to-female adapter BNC T-adaptor male-female-female
1 piece	Storage kit

Part No.	Description	1	10
207079CD	Network connector kit	\$49.95	\$44.95

Network Starter Kit - Easy/Fast



SALE

Everything you need to set up a simple network. No need to worry about compatibility or complicated installations.

- Single chip controller on PCI network card complies to bus specification 2.1
- Auto negotiation capability
- Conforms with IEEE standards
- Shielded RJ45 connector on network card
- On-board socket for an optional remote boot ROM
- LED diagnostic to monitor network conditions
- 5-port hub supports 10/100Mbps
- Power, link/active/speed, FDX/collision indicators for network status
- Up-link port for expansion

Includes: Two each PCI network cards, Two each 15' straight-through cables, 5-port mini hub, 7.5VDC @ 1A wall transformer, 3.5" disk drivers and manual

Part No.	Description	1	10
208469CD	Network starter kit	\$59.95	\$53.99

AUI/10BaseT Transceiver

Provides connectivity with work stations equipped with AUI ports to 10BaseT ethernet local area network. Switch selectable SQE (signal quality error)/ "Heartbeat Test" to detect collision circuitry in operation.



- IEEE 802.3 10BaseT compliancy
- 4 LED indicators for receive, transmission, collision and link
- SQE enable/disable switch
- AUI 15-pin male connector, RJ45 connector
- Size: 2.3"L x 1.7"W x 0.8"H • Weight: 0.2 lbs.

Part No.	Description	1	10
215917CD	Ethernet transceiver	\$29.95	\$27.95

Intel® AnyPoint Home Network

Powerful, Simple, Fast Network!

Save money sharing files, printers, modems and DSL connections on a network. In the past, networking has been reserved for companies and businesses, since the cost of setting up one for home use was too expensive to be justified. However the use of computers is increasing and households having more than one is becoming much more common. Installing networks require Ethernet cards, hubs, cables, reading extensive manuals, opening up your computer to install hardware, and so on. Wouldn't it be nice if setting up your network was as easy as plugging in a keyboard or a mouse? Intel thought so, and introduced the AnyPoint Home Networking System. Install this network in three easy steps: connect the cables to the parallel port of your PC & existing phone lines of your home, install the software with it's tutorial interface, and you have a network up and running.



- Freq. range: 5.5 to 9.5MHz
- Max. distance between nodes: 500'
- Controller: Intel® 21145 phonenumber/Ethernet LAN controller
- No wires or cables to run: use existing phone lines
- 3 easy steps to install a complete network
- Save money by sharing a printer and having both computers access the same internet connection
- Size: 8.0"H x 3.8"W x 3.8"D

Includes: 2 phone cables, 2 data cables (parallel cables), 2 power supplies, manual & CDROM drivers
System requirements: 486 or higher processor, Windows 95/98, 8MB of RAM, 18MB of hard disk space, parallel port for printer use

Part No.	Description	Price
220417CD	Home network	\$29.95

Special Purchase
Was \$189.99
Now \$29.95

PCI Ethernet Card

10/100Mbps, Auto Detect

- 32-bit PCI bus mastering for high throughput and low CPU command
- Complies with IEEE 802.3 ethernet standards
- Auto set IRQs & I/O address
- Auto negotiation functions
- Plug & Play installation
- Full duplex and half duplex operation
- RJ45

Includes: 3.5" disk drivers and manual

Part No.	Description	1	10	25
173606CD	RJ45 (10/100Mbps)	\$14.95	\$13.49	\$12.15



ISA Ethernet Card

10Mbps

- Supports Novell NetWare, Windows® NT, LAN Manager, UNIX TCP/IP, Windows® 95/3.1
- LED indicators for diagnostics
- FCC class approved

Includes: 3.5" disk driver

Part No.	Description	1	10
144936CD	RJ45 and BNC	\$14.95	\$13.49



8-Port Ethernet Hub

Designed to the exacting standards of IBM for use in large corporate networks, but its price and easy setup makes it perfect for home or small office use. Compatible with all standard STP, UTP, and FTP cables. Can be cascaded to support larger networks via the MDI (uplink) port. Provides port-by-port link/activity and partition LEDs. Partitions ports automatically when excessive collisions or jabbering are detected.



NEW

- Conforms to IEEE 802.3 10Base-T standards
- AUI port allows for connection to 10BASE-2, 10BASE-5, and 10BASE-F Ethernets
- MDI port allows cascading of 8242's with straight through cables
- Crossover ports, automatic partitioning
- Size: 8.7"W x 5.3"D x 1.1"H
- Weight: 1.7 lbs.

Special Purchase
Save \$88.00
Was \$133.00

Part No.	Product No.	1	10
226149CD	8242	\$44.95	\$39.95

Professional Rackmount Fast Ethernet Switch Hubs

- Eliminate bottlenecks and improve your small business network with true 100Mbps connection from JAMECO's choice as the best performance/ value combination in networking - PHOEBE.
- Store and forward architecture that eliminates error packets
- LED indicators for link/activity
- Deliver non-blocking performance at full-duplex on all ports
- 10/100Mbps RJ45 ports
- IEEE 802.3 10Base-T and 802.3U 100Base-TX
- Filter/forward rate of 148,800 packets/sec
- Power requirements: 100-240VAC
- MDI/MDIX supported
- Size: 17.4"W x 5.5"D x 1.8"H



215837CD

Part No.	Description	Wt. (lbs.)	1	10
215651CD	16-port	5.3	\$93.95	\$86.95
215669CD	24-port	5.7	169.95	161.95
215837CD	32-port	7.7	269.95	251.95

NETGEAR® PCMCIA Network Card

Share printers and access to the internet, send and receive email and messages, drag and drop files between computers.



- Auto detection of 10/100Mbps speed (10Base-T / 100Base-Tx)
- Full duplex capability
- LED indicator for 100Mbps activity and link activity
- PCMCIA type II
- Plug and play, easy installation

Requirements: 486/Pentium® compatible laptop, PCMCIA slot (type II), Windows® operating system

Includes: 3.5" disk, PCMCIA to RJ45 adapter & cable

Part No.	Description	1	10
210972CD	PCMCIA network card	\$29.95	\$27.95

UTP Ethernet Cable Tester

- Connector type: RJ45 8P8C
- System used: 258A, 356A, AT&T/Ethernet 10BaseT
- Miswire, open, short tests
- Size 4.5"L x 2.5"W x 1.3"H

Requires: 9V battery (recommend P/N 151095CD, pg 202)

Includes: Zipper case



Part No.	Description	1	10
115895CD	Network Cat. 5 tester	\$29.95	\$26.95

Modular Cable Tester with Remote Terminator

Easily read correct pin configuration of 10baseT, 10base2, RJ45/RJ11 modular cables, 258A, TIA568A/568B, token ring, etc. Test installed cables either on wall plate or patch panel from a distance.



- Check for cable continuity, miswiring, open, short, grounding, and pin configurations
- Cable adapters: RJ45 M-M, 2 RJ45M-BNCM and BNC F-F • Weight: 0.7 lbs.
- On-board conn.: 2 RJ45F (tester) and 1 RJ45F (remote) • One-year warranty
- Size: 4.0"L x 2.5"W x 1.0"H (Main console)
- Size: 4.0"L x 1.3"W x 1.0"H (Remote)

Includes: Manual and test cables

Part No.	Description	1	10
145710CD	Modular cable tester	\$84.95	\$76.49

Tone Generator & Amplifier Probe

For Tracing Wires & Cables

- Tests wire trace, continuity, clear/busy/ringing line, tip/ring identification
- Insulated inductive probe tip prevents shorting conductors
- Selectable continuous or variable tone generation
- Built-in speaker on probe with sensitivity control
- Output jacks for both headphones and handsets

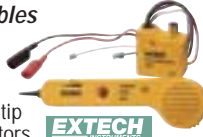

Includes: Alligator test leads, modular phone connector cables, 9V battery, and carrying pouch

Part No.	Description	1	10
198002CD	Tone generatr & amp. probe	\$79.95	\$71.95

Category 6 Network Cables



- Assembled using ETL verified 24AWG stranded cable • Gold over nickel contacts
- Exceeds performance levels as specified in TIA/EIA 568B.2-1 Category 6 draft 8

Category 6 (200MHz)

Part No.	Description	Color	1	10	100
219707CD	3ft. Cable RJ45	Gray ...	\$6.29	\$5.79	\$5.29
219715CD	7ft. Cable RJ45	Gray	7.99	7.39	6.79
219723CD	14ft. Cable RJ45	Gray	8.99	8.29	7.59
219731CD	25ft. Cable RJ45	Gray ...	13.49	12.39	11.39
219740CD	50ft. Cable RJ45	Gray ...	22.49	20.69	18.99
219854CD	3ft. Cable RJ45	Blue	6.29	5.79	5.29
219862CD	7ft. Cable RJ45	Blue	7.99	7.39	6.79
219871CD	14ft. Cable RJ45	Blue	8.99	8.29	7.59
219889CD	25ft. Cable RJ45	Blue ...	13.49	12.39	11.39
219897CD	50ft. Cable RJ45	Blue ...	22.49	20.69	18.99
220003CD	3ft. Cable RJ45	White ...	6.29	5.79	5.29
220011CD	7ft. Cable RJ45	White ...	7.99	7.39	6.79
220020CD	14ft. Cable RJ45	White ...	8.99	8.29	7.59
220038CD	25ft. Cable RJ45	White ...	13.49	12.39	11.39
220046CD	50ft. Cable RJ45	White ...	22.49	20.69	18.99
219900CD	3ft. Cable RJ45	Red	6.29	5.79	5.29
219918CD	7ft. Cable RJ45	Red	7.99	7.39	6.79
219926CD	14ft. Cable RJ45	Red	8.99	8.29	7.59
219934CD	25ft. Cable RJ45	Red ...	13.49	12.39	11.39
219942CD	50ft. Cable RJ45	Red ...	22.49	20.69	18.99
219803CD	3ft. Cable RJ45	Green ...	6.29	5.79	5.29
219811CD	7ft. Cable RJ45	Green ...	7.99	7.39	6.79
219820CD	14ft. Cable RJ45	Green ...	8.99	8.29	7.59
219838CD	25ft. Cable RJ45	Green ...	13.49	12.39	11.39
219846CD	50ft. Cable RJ45	Green ...	22.49	20.69	18.99
219758CD	3ft. Cable RJ45	Black	6.29	5.79	5.29
219766CD	7ft. Cable RJ45	Black	7.99	7.39	6.79
219774CD	14ft. Cable RJ45	Black	8.99	8.29	7.59
219782CD	25ft. Cable RJ45	Black ...	13.49	12.39	11.39
219791CD	50ft. Cable RJ45	Black ...	22.49	20.69	18.99
219951CD	3ft. Cable RJ45	Yellow ..	6.29	5.79	5.29
219969CD	7ft. Cable RJ45	Yellow ..	7.99	7.39	6.79
219977CD	14ft. Cable RJ45	Yellow ..	8.99	8.29	7.59
219985CD	25ft. Cable RJ45	Yellow ...	13.49	12.39	11.39
219993CD	50ft. Cable RJ45	Yellow ...	22.49	20.69	18.99

"Cat 5e Vs. Cat 6"

The general difference between category 5e and category 6 is in the transmission performance, and extension of the available bandwidth from 100 MHz for category 5e to 200 MHz for category 6. This includes better insertion loss, near end crosstalk (NEXT), return loss, and equal level far end crosstalk (ELFEXT). These improvements provide a higher signal-to-noise ratio, allowing higher reliability for current applications and higher data rates for future applications.

What is the difference between enhanced category 5e cable rated for 350 MHz and category 6 cable rated for 200 MHz?

Category 5e cable is specified up to 350 MHz. Cables can be tested up to any frequency that is supported by the test equipment, but such measurements are meaningless without the context of applications and cabling standards. The category 6 standard sets minimum requirements up to 200 MHz for cables, connecting hardware, patch cords, channels and permanent links, and therefore guarantees reasonable performance that can be utilized by applications.

Are the connectors for category 5e and category 6 different? Why are they more expensive?

Although category 6 and category 5e connectors may look alike, category 6 connectors have much better transmission performance. For example, at 100 MHz, NEXT of a category 5e connector is 43 decibels (dB), while NEXT of a category 6 connector is 54 dB. This means that a category 6 connector couples about 1/12 of the power that a category 5e connector couples from one pair to another pair. Conversely, one can say that a category 6 connector is 12 times less "noisy" compared to a category 5e connector. This vast improvement in performance was achieved with new technology, new processes, better materials and significant R&D resources, leading to higher costs for manufacturers.

019" Rack Mount Patch Panels

Our CAT 5 patch panels feature 110D punch blocks that are compatible with KRONE or 110D tool. UL and CUL listed and certified, CAT 5 certified and can be used with T568 A/B installations. Blocks are color coded for T568 color-coding, and easy wire management.

Part No.	Description	1	10
208768CD	12-port patch panel	\$35.95	\$32.95
208784CD	24-port patch panel	65.95	59.95

PC Testing & Diagnostics

Computer Monitor & NTSC Tester

Mac, PC and TV

- Tests VGA, Super VGA, Mac monitors and TVs
- Checks full-field color bars, color raster, dots (static and dynamic convergence), cross-hatch and windows (power supply regulation, checks for a clear distinction between white and black portions)
- Connectors: HDDB15F, DA15F
- Two video conn. for TV, composite and S-video
- Power with either a 9V battery or an external DC adapter (recommend P/N 151095CD, pg 202 or P/N 100845CD, pg 55)
- Size: 5.5"L x 3.0"W x 1.4"H
- Weight: 0.7 lbs. • One-year warranty



Part No.	Description	1	10
149729CD	Computer monitor tester	\$189.95	\$179.95

Diagnostic Card for PCI-Bus Systems

This is the first diagnostic card for monitoring Power-On-Self-Test results in systems using PCI-Bus architecture.

- Plugs into any PCI I/O slot
- Digital indicators for every POST code error
- LEDs for monitoring power (DC): +12, -12, +5, +3
- LEDs for clock and reset failure
- Comprehensive manual w/ error codes from all major BIOS manufacturers including AMI, AWARD, PHOENIX and more • One-year warranty



Part No.	Description	1	10
135108CD	PCI-POST diagnostic card	\$274.95	\$259.95

PC Diagnostic Software "Quicktech '98"

Self-booting software for 386, 486 and Pentium® II/MMX/III/AMD Athlon

- Verify proper operation and troubleshoot failures of all major PC components: hard drives (MFM, RLL, IDE, SCSI); floppy drives; base, extended and external cache RAM; VGA/EGA/VESA compliant video cards; keyboard; monitor; printer; and I/O ports
- 48 hour burn-in mode for lengthy testing
- Floppy drive head cleaning function

Includes: Loopback testers for DB9 and DB25 serial and DB25 parallel ports, manual and 3.5" disk

Part No.	Description	1	10
134826CD	QuickTech '98 software	\$148.95	\$134.95

Category 5e Network Cables



- 4 pair
- 24 AWG (7 x 43) stranded
- UTP • 8P8C
- "Snagless" boot
- Color coded for easy wire tracing
- High-flexibility
- Achieve optimum system performance

124741CD 124863CD 124687CD

Category 5e (350MHz)

Part No.	Description	Color	1	10	100
168292CD	3ft. cable RJ45	Gray	\$1.79	\$1.49	\$1.39
168305CD	7ft. cable RJ45	Gray	2.99	2.59	2.39
168313CD	15ft. cable RJ45	Gray	5.29	4.39	3.99
168321CD	25ft. cable RJ45	Gray	7.99	6.79	6.39
201777CD	3ft. cable RJ45	Red	1.79	1.49	1.39
201785CD	7ft. cable RJ45	Red	2.99	2.59	2.39
201793CD	15ft. cable RJ45	Red	5.29	4.39	3.99
201806CD	25ft. cable RJ45	Red	7.99	6.79	6.39
201697CD	3ft. cable RJ45	Black	1.79	1.49	1.39
201700CD	7ft. cable RJ45	Black	2.99	2.59	2.39
201718CD	15ft. cable RJ45	Black	5.29	4.39	3.99
201726CD	25ft. cable RJ45	Black	7.99	6.79	6.39
201734CD	3ft. cable RJ45	Blue	1.79	1.49	1.39
201742CD	7ft. cable RJ45	Blue	2.99	2.59	2.39
201751CD	15ft. cable RJ45	Blue	5.29	4.39	3.99
201769CD	25ft. cable RJ45	Blue	7.99	6.79	6.39
201814CD	3ft. cable RJ45	Yellow	1.79	1.49	1.39
201822CD	7ft. cable RJ45	Yellow	2.99	2.59	2.39
201831CD	15ft. cable RJ45	Yellow	5.29	4.39	3.99
201849CD	25ft. cable RJ45	Yellow	7.99	6.79	6.39

Category 5 (100MHz)

Part No.	Description	Color	1	10	100
175273CD	7ft. cable RJ45	Gray	\$1.49	\$1.35	\$1.25
124732CD	7ft. cable RJ45	Red	1.49	1.35	1.25
124741CD	15ft. cable RJ45	Red	2.39	2.15	1.95
124847CD	3ft. cable RJ45	Black	1.15	1.05	.95
203051CD	10ft. cable RJ45	Blue	1.95	1.69	1.25
170190CD	25ft. cable RJ45	Blue	3.55	3.05	2.29
124695CD	7ft. cable RJ45	Yellow	1.49	1.35	1.25

Blow-out Prices!

Telecom Splice Connectors

- Provides clean, solid, and rapid connection of wires to keep communication lines free of noise
- Available to handle a wide range of conductor sizes



169746CD 169754CD

SALE

169754CD: Y-Type

- Prepackaged: order in increments of 10, 100 or 1000

Part No.	Color	Wire Gauge	No. of Conductors	10	100	1000
169746CD	Yellow	22-26	2	\$.11	\$.10	\$.08
169754CD	Red	19-26	3Y	.15	.14	.12

Token Ring-to-RJ45 Adapter

- Easy connection to UTP cabling
- Use type A or B style data connector with RJ45 jack
- Determine cable length (flexibility)
- Dimensions: 2.5"L x 1.0"W



SALE

Part No.	Description	1	10	100
125461CD	Token ring	\$8.45	\$7.59	\$6.85

Keystone-Type Wall Plates



195549CD 195557CD 212986CD 212960CD

- Size: 2.8"W x 4.5"H

Part No.	No. of ports	Color	1	10	100
195549CD	1	Ivory	\$1.25	\$1.15	\$.99
195557CD	2	Ivory	1.25	1.15	.99
195565CD	3	Ivory	1.25	1.15	.99
195573CD	4	Ivory	1.25	1.15	.99
212978CD	1	White	1.25	1.15	.99
212994CD	2	White	1.25	1.15	.99
212986CD	3	White	1.25	1.15	.99
212960CD	4	White	1.25	1.15	.99
213508CD	Hole filler	White	.28	.25	.23

Modular Jacks

Punchdown Keystone Type

- Removable jacks used in wall plates (clip in)
- CAT 5e classification
- Punchdown type wiring connections with color coding
- Size: 0.57"W x 0.63"H x 1.23"D
- RJ45: 8P8C RJ11: 6P6C



212943CD 213516CD

RJ45

Part No.	Color	1	10	100
195590CD	Red	\$3.59	\$3.39	\$3.19
195602CD	Yellow	3.59	3.39	3.19
195611CD	Green	3.59	3.39	3.19
195629CD	Black	3.59	3.39	3.19
195637CD	Ivory	3.59	3.39	3.19
212951CD	Blue	3.59	3.39	3.19
212943CD	White	3.59	3.39	3.19

RJ11

Part No.	Color	1	10	100
213524CD	Black	\$3.59	\$3.39	\$3.19
213516CD	White	3.59	3.39	3.19

BNC/F-Type Jacks



195645CD 224645CD

- Removable jacks used in wall plates (see above)
- Clip on for easy installation on wall plates
- Keystone type

Part No.	Description	Color	1	10	100
195645CD	F-Type F to F	Ivory	\$1.39	\$1.29	\$1.19
224645CD	F-Type F to F	White	1.39	1.29	1.19
195653CD	BNC F to F	Ivory	2.29	2.05	1.89
224637CD	BNC F to F	White	2.29	2.05	1.89

CAT 5e Crossover Cable

- Connect 2 PCs without a hub
- 24AWG (7 x 43) stranded
- Strain relief RJ45 connectors
- 4-pair • 8P8C • UTP



Part No.	Description	1	10	100
169261CD	10' cable RJ45, gray	\$6.95	\$6.25	\$5.59

Bulk Modular Network Cables

- 8 Conductor • UTP
- 4 twisted pairs
- Insulation: polyethylene
- Nom. OD.: 189"
- Nominal impedance: 100Ω
- Solid: uses modular plug P/N 119343CD, pg 195
- Stranded: uses modular plug P/N 79281CD, pg 195
- 118130CD/201646CD: 7/32 AWG
- Prepackaged and priced in increments of 25' or 100'



118130CD

24 AWG UTP Category 5e – 350MHz

Part No.	Description	25 ft.	100 ft.	1000 ft.
176225CD	Solid (gray)	\$5.00	\$17.00	\$100.00
201603CD	Solid (blue)	5.00	14.00	90.00
176233CD	Stranded (gray)	6.00	21.00	180.00
201574CD	Stranded (red)	6.00	18.00	160.00
201591CD	Stranded (black)	6.00	18.00	160.00
201582CD	Stranded (blue)	6.00	18.00	160.00
201566CD	Stranded (yellow)	6.00	18.00	160.00

24 AWG UTP Category 5 – 100MHz

Part No.	Description	25 ft.	100 ft.	1000 ft.
118113CD	Solid (gray)	\$4.59	\$16.49	\$129.50
118130CD	Stranded (gray)	5.95	19.35	164.50
201646CD	Stranded (black)	5.50	15.00	140.00

Modular Jack Boxes & Wall Plate



Fig. 1 W: 2.8" H: 4.5" (72311CD) Fig. 2 W: 2.0" H: 2.2" D: 0.9" (71651CD) Fig. 3 W: 1.5" H: 2.4" D: 1.1" (213031CD) Fig. 4 W: 2.4" H: 2.4" D: 1.1" (213049CD)

Part No.	Description	Fig.	1	10	100
72311CD	6P6C & 8P8C double wall jack plate w/ jacks (beige)	1	\$1.95	\$1.75	\$1.57
103464CD	6P4C adhesive jack RJ11 (beige)	2	1.39	1.19	1.09
71984CD	6P6C adhesive jack RJ11 (beige)	2	1.39	1.19	.99
71651CD	8P8C adhesive jack RJ45 (beige)	2	1.95	1.65	1.45
213031CD	8P8C adhesive jack RJ45 (single, white) (CAT 5e)	3	3.29	2.99	2.69
213049CD	8P8C adhesive jack RJ45 (dual, white) (CAT 5e)	4	4.15	3.75	3.39

Surface Mount Boxes

Category 5 and 5e

- RJ45
- 8P8C
- 100MHz
- Size: 2.6"L x 3.2"W x 1.2"H



176073CD 213014CD

Part No.	Description	1	10	100
176073CD	Single jack (beige)	\$6.95	\$6.25	\$5.59
213022CD	Single jack (white, CAT 5e)	6.95	6.25	5.59
176081CD	Dual jack (beige, CAT 5e)	9.99	8.99	8.09
213014CD	Dual jack (white, CAT 5e)	9.99	8.99	8.09

Corporate Customers

Opening an account is easy!!

Call 1-800-831-4242

for details today.

Slim-Line D-Sub Gender Changers



For Confined Applications!

These revolutionary slim-line gender changers are only 0.69" wide, eliminating the space problems caused by standard gender changers. When plugged into your existing cable, they add only 0.44" to the cable. All-metal cases.

- Captive locking screw (male)
- Captive locking nut (female)
- Grounding tangs (male)



Part No.	Description	1	10	100
18497CD	9-pin male	\$4.95	\$4.49	\$3.99
18489CD	9-pin female	4.95	4.49	3.99
56071CD	15-pin male	3.95	3.49	2.95
56063CD	15-pin female	3.95	3.39	2.55
119319CD	15-pin female HD	4.29	3.89	3.49
119301CD	15-pin male HD	4.95	4.49	3.95
18446CD	25-pin male	4.95	4.49	3.99
18420CD	25-pin female	4.95	4.49	3.99
170085CD	25-pin M-F	2.95	2.55	1.89

D-Sub 9-Pin to 25-Pin Serial Adapters



10305CD: For use in AT or other computer systems that have 9-pin D-sub serial ports.

153576CD/10321CD/163740CD: For PC/XT systems with DB25 serial ports.

154683CD: 4-40 x .24" hex nut (4)
189632CD: thumbscrews
139985CD: gold-plated contacts, extra long thumbscrews

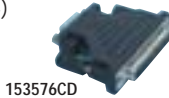

Part No.	Description	1	10	100
10305CD	DB9 F to DB25 M	\$3.49	\$2.99	\$2.25
163740CD	DB9 M to DB25 F, thumbscrews on DB9 side only	2.85	2.45	1.85
153576CD	DB9 M to DB25 F, thumbscrews on DB25 side only	3.95	3.59	2.99
10321CD	DB9 M to DB25 F	4.49	3.79	3.19
154683CD	DB9 F to DB25 F	2.49	2.15	1.59
189632CD	DB9 M to DB25 M	3.49	3.15	2.85
139985CD	DB9 F to DB25 F	3.95	3.55	3.19

6-Pin Male Mini DIN to 9-Pin Male D-Sub Adapters



Pin-to-pin connections:

6-pin male mini DIN	1	2	3	4	5	6
9-pin male D-sub						
100335CD	1	—	3, 9	2, 5, 7	6	—
180523CD	2	3	5	4, 7	5	—

- Color: beige
- Size: 1.6"L x 1.3"W

Part No.	Description	1	10	100
100335CD	W/ thumbscrew	\$3.45	\$3.09	\$2.79
180523CD	Cable adapter (1 ft.)	1.95	1.79	1.59

Standard D-Sub Gender Changers

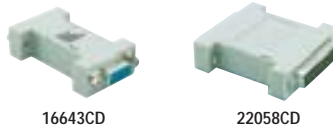

- Standard 9- and 25-pin D-sub male and female gender changers for interfacing two cables or connectors of the same gender

Part No.	Description	1	10	100
16635CD	D-sub 9-pin male	\$1.95	\$1.75	\$1.49
16643CD	D-sub 9-pin female	1.95	1.75	1.49
22058CD	D-sub 25-pin male	1.95	1.49	1.05
22074CD	D-sub 25-pin female	1.99	1.79	1.65

AT and PS/2 Keyboard Adapters



159089CD/189771CD: AT keyboard adapter

- Connects PS/2 keyboard to AT
- 6-pin female mini DIN to 5-pin male DIN

159097CD/157930CD: PS/2 keyboard adapter

- Connects AT type keyboards to the PS/2
- 5-pin female DIN to 6-pin male mini DIN (PS/2)

Part No.	Length	Housing	1	10	100
159089CD	1.6"	Metal	\$2.95	\$2.65	\$2.39
159097CD	1.4"	Metal	2.95	2.65	2.39
157930CD	1.7"	Plastic/metal	3.49	2.65	2.39
189771CD	1.7"	Plastic	2.95	2.65	2.39

15-Pin to 9-Pin VGA Adapter

- Adapts 15-pin VGA to 9-pin output
- Male HDDB15 to female DB9 adapter



Part No.	Description	1	10	100
75264CD	VGA adapter	\$4.45	\$3.95	\$3.55

Laptop Computer Power Cord

- 2-conductor power cord for laptop computers
- 18/2 AWG • 6' cord
- Flat junior duty type cord



Part No.	Description	1	10
189587CD	6' laptop power cord	\$2.95	\$2.49

Macintosh® to IBM Monitor Adapters and Cables

Allows use of Macintosh® computer with IBM monitor (DA15 male to HDDB15 female).

126439CD:

- 10 position DIP-switch supports 6 kinds of signal modes and resolutions
- Size: 2.0"L x 1.5"W
- One-year warranty

183345CD:

- DA15 female to HDDB15 male
- Size: 2.2"L x 1.6"W x 0.6"H



Part No.	Description	1	10	25
126439CD	Mac to IBM adapter	\$8.95	\$7.95	\$6.95
183345CD	Mac to IBM (SVGA)	2.69	2.45	2.19

Full Handshaking Null Modem Adapters

Self-contained null-modem (cross-over) adapters. Change any standard straight cable into a null cable quickly and easily.



Internal pin configuration:

- 17224CD:** 1-1, 2-3, 3-2, 4-5, 5-4, 6-20, 20-6, 7-7, 8-20
26243CD: 1-1, 2-3, 3-2, 4-8, 8-4, 5-8, 8-5, 6-20, 20-6, 7-7

Part No.	Description	1	10	100
26243CD	DB25 M to DB25 F	\$3.95	\$3.49	\$3.65
17224CD	DB25 F to DB25 F	3.49	2.95	2.49

IEEE 1284 Parallel & Serial Cables for High Speed

The IEEE 1284 is the standard in high speed printing. Compatible w/ bidirectional communication data flow resulting in speeds up to 10 times faster than conventional applications.



- Double shielded with 28 AWG stranded twisted pair inner conductors
- Molded shells, PVC plastic
- Color: beige (P/N 130067CD/168233CD); black (P/N 161630CD); gray (P/N 172304CD/223845CD)
- Weight: 0.6 lbs.

Part No.	Description	1	10
130067CD	6' DB25 M-Cent. parallel 36M	\$11.95	\$10.95
223845CD	6' DB25 M-Cent. parallel 36M	11.95	10.95
168233CD	6' DB25 M-F parallel cable	6.95	5.95
161630CD	10' DB25 M-M serial cable	14.95	13.49

IEEE 488 Cables

A variety of cable lengths are offered to ensure that the IEEE system requirements are met (20 meters maximum length with a maximum of 15 devices).



These cables are standard IEEE 488 cables with stackable 24-pin GPIB connectors on both ends.

- Color: gray

Part No.	Description	Wt. (lbs.)	1	10	25
73154CD	1 meter	0.8	\$36.49	\$32.79	\$29.49
115781CD	2 meter	1.2	37.95	34.19	30.95
115801CD	4 meter	2.0	34.95	29.75	22.29

Apple Macintosh® Printer Cables



Part No.	Description	1	10	50
10604CD	6' mini DIN8M	\$4.95	\$4.45	\$3.99
130024CD	10' mini DIN8M	5.99	5.39	4.85

See the yellow and green highlighted items.

Jameco Special Values!

Details on page 4.

Modular Plugs



P = No. of positions
C = No. of contacts
W/E = Western Electric type number

* Prepackaged: order in increments of 10, 100 or 1000

Part No.	Description	W/E	1	10	100	1000
103491CD	4P4C (handset)	616	*	\$.11	\$.094	\$.07
79290CD	6P4C (RJ11)	623	*	.12	.11	.095
79273CD	6P6C (RJ11)	623	*	.22	.195	.18
79281CD	8P8C (RJ45) (for stranded wire)	641	*	.28	.24	.20
119343CD	8P8C (RJ45) unshielded (for solid wire)	—		.49	.44	.35
116610CD	8P8C (RJ45) shielded	—		1.09	.99	.89
204222CD	8P8C (RJ45) shielded (for STP solid wire)	—		1.69	1.55	1.39
204231CD	8P8C (RJ45) shielded (for STP stranded wire)	—		1.69	1.55	1.39
116601CD	8P8C (RJ45) shielded (for solid wire)	—		.99	.85	.69
204249CD	10P10C (for STP solid wire)	—		1.69	1.39	1.25
180646CD	10P10C (for stranded wire)	—		1.39	1.15	.82

Modular Jacks

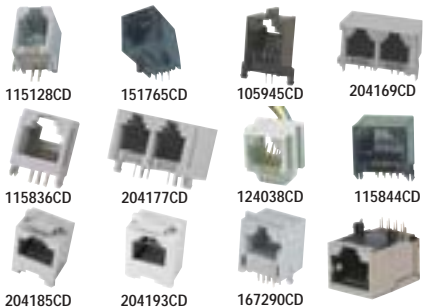

- PC mount
- Voltage rating: 150 volts AC max.
- Contact current rating: 1.5 amp max. @ 25°C
- Durability: 750 mating cycles

W/E = Western Electric type number

Part No.	Description	W/E	1	10	100
199620CD	4P4C (handset) .48"W	—	\$.59	\$.49	\$.39
115128CD	4P4C (handset) .395"W	—	.37	.34	.31
151765CD	6P4C (RJ11) side flange	AMP	.45	.43	.39
105945CD	6P4C (RJ11) top flange	623	.62	.52	.45
204169CD	6P4C (RJ11) dual	—	1.39	1.25	1.15
204206CD	6P4C (RJ11) lead wires	—	1.09	.99	.89
115836CD	6P6C (RJ11) side flange	—	.74	.67	.59
204177CD	6P6C (RJ11) dual	—	1.49	1.35	1.19
124038CD	6P6C (RJ11) 6" leads	—	1.25	1.15	.99
115844CD	8P8C (RJ45)	641	.48	.44	.40
204185CD	8P8C (RJ45) w/ key	—	.65	.59	.53
204193CD	8P8C (RJ45) w/o key	—	.65	.59	.53
204214CD	8P8C (RJ45) .81"L	—	1.39	1.19	.99
167290CD	8P8C (RJ45) top flange	—	.39	.35	.30
203449CD	8P8C (RJ45) shielded Pin spacing "A" = .055"	—	1.19	.99	.85

"EZ" RJ45 Connector

Strip the wire and insert into the plug and pull out the wire on the other side. This ensures correct conductor order and uniformity in crimping. No wire bar and no wasted cable.

- For solid or stranded wire
- Use standard modular crimping tool
- 8P8C plug

Part No.	Product No.	1	10	100	250
158115CD	RJ45 (8P8C)	\$1.75	\$1.58	\$1.42	\$1.25

Modular Couplers and Adapters



Style 1 Reverse wiring for telephone systems



Style 2 Straight wiring for networking/printer sharing

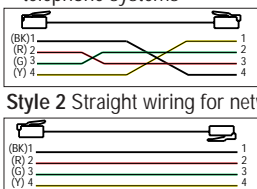

Cat 5 coupler!

Part No.	Description	Fig.	1	10	100
72207CD	6P4C male "T" adapter, Style 2. Provides 2 jacks from 1 line. Male modular plug (6P4C), 2 female modular receptacles (6P4C) RJ11	2	\$.99	\$.85	\$.65
71757CD	6P6C modular coupler, Style 1, RJ11	1	.95	.86	.79
135087CD	6P6C modular coupler, Style 2, RJ11	1	.99	.85	.65
181091CD	6P6C male "T" adapter, Style 2. Provides 2 jacks from 1 line. Male modular plug (6P6C), 2 female modular receptacles (6P6C) RJ11	2	.99	.89	.78
118501CD	8P8C modular coupler, Style 1, RJ45	1	1.95	1.79	1.59
135079CD	8P8C modular coupler, Style 2, RJ45	1	1.39	1.25	1.15
153023CD	8P8C modular coupler, Style 2 (for Cat. 5) RJ45	3	7.99	7.19	6.49
172814CD	8P8C modular coupler, Style 1 (for Cat. 5) RJ45	4	7.49	6.75	6.09

RJ45-Plug Color Caps (Boots)

- Round strain relief • 10 piece minimum

Part No.	Description	10	50	100
204409CD	Black	\$.14	\$.12	\$.115
204388CD	Yellow	.14	.12	.115
204353CD	Gray	.14	.12	.115
204361CD	Blue	.14	.12	.115
204425CD	Red	.14	.12	.115
204396CD	Green	.14	.12	.115
204370CD	Ivory	.14	.12	.115

For more RJ45 Plug Boots
See www.Jameco.com



RS-232-to-RJ11/RJ45 Modular Jack Adapters

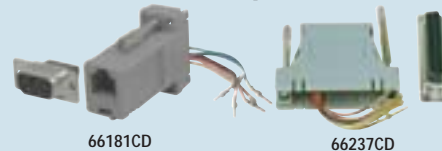

Change your RS-232 port to a RJ11 or RJ45 modular jack. This will allow you to use modular phone cable rather than RS-232 cable, thus simplifying networking applications. Comes complete with all necessary wiring and hardware.

Part Number	Description	Pricing		
		1	10	100
204265CD	DB9 M to RJ11(6P4C)	\$1.95	\$1.75	\$1.49
66181CD	DB9 M to RJ11(6P6C)	2.59	2.35	2.09
66190CD	DB9 M to RJ45(8P8C)	2.89	2.65	2.35
114737CD	DB9 F to RJ11(6P4C)	1.95	1.79	1.59
66202CD	DB9 F to RJ11(6P6C)	2.79	2.55	2.29
66211CD	DB9 F to RJ45(8P8C)	2.99	2.69	2.45
204281CD	DB25 M to RJ11(6P4C)	2.69	2.45	2.19
66229CD	DB25 M to RJ11(6P6C)	2.95	2.35	1.99
66237CD	DB25 M to RJ45(8P8C)	2.99	2.69	2.45
204273CD	DB25 F to RJ11(6P4C)	1.95	1.69	1.25
66245CD	DB25 F to RJ11(6P6C)	2.59	1.95	1.39
66253CD	DB25 F to RJ45(8P8C)	2.89	2.59	2.29

Modular Telephone/Printer Sharing Cables (Gray)

- RJ11 – 6P2C/6P4C for telephone or network
 - RJ11 – 6P6C for telephone or printer sharing
 - RJ45 – 8P8C for telephone or modem-dial-up use
- Style 1 – Reverse wiring for telephone systems
Style 2 – Straight wiring for networking/printer sharing

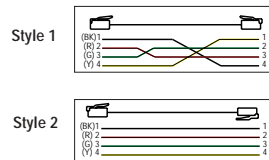

* 10 pc. min.

Part No.	Conn. Style	Type	Length	Pricing		
				1	10	100
195733CD	1	RJ11-6P2C*	7ft.	\$.39	\$.35	\$.31
189940CD	1	RJ11-6P2C	7ft.	.99	.85	.65
189931CD	1	RJ11-6P4C	1ft.	*	.09	.06
196226CD	1	RJ11-6P4C	7ft.	1.49	1.35	1.19
115553CD	2	RJ11-6P4C	7ft.	1.25	1.09	.89
205903CD	1	RJ11-6P4C†	14ft.	1.25	1.09	.99
115545CD	1	RJ11-6P4C	25ft.	2.29	2.09	1.85
201232CD	2	RJ11-6P4C†	35ft.	1.95	1.79	1.59
115588CD	1	RJ11-6P6C	7ft.	1.55	1.35	1.15
115617CD	2	RJ11-6P6C	7ft.	2.19	1.99	1.79
115676CD	2	RJ45-8P8C	7ft.	1.89	1.75	1.49
115684CD	2	RJ45-8P8C	14ft.	2.95	2.69	2.39

* Black † Beige

For new Category 6 cables
see page 192



5.6" Color TFT Monitor

NTSC Format

- TFT color LCD display
- 224,640 pixel display resolution
- Built-in 1 watt speaker
- Brightness, color and volume adjustments
- Video input: 1.0Vp-p; 75Ω
- Audio input: 2Vp-p; 2kΩ
- Size: 6.1"W x 4.8"H x 1.2"D • Weight: 2.6 lbs.



Includes: RCA cable, mounting stand with hardware and 12VDC @ 500mA power supply

Part No.	Description	1	10
201702CD	5.6" TFT color monitor	\$279.95	\$259.95

4" TFT LCD Monitor

NTSC Format

- TFT color LCD
- Resolution 234 x 383dpi
- Backlight: cold cathode fluorescent lamp
- Power source: 12VDC @ 400mA
- 5" long lead wire with 4 position molex type power connector
- Tint color and brightness adjustable
- Size: 4.1"L x 3.3"W x 0.7"H (display)
- Size: 4.7"L x 3.3"W x 1.3"H (unit) • Weight: 0.7 lbs.



Part No.	Description	1	10
172742CD	4" color LCD monitor	\$159.95	\$149.95

Video Text Display Module

NTSC composite (1Vp-p, 75Ω)

- Serial data input: 2400-19.2kbps
- 30-pin SIMM form factor (socket supplied)
- Compatible with Parallax Basic Stamp®, see pg 200
- Auto-switching genlock overlay or internal video generation
- Power supply: +8-16VDC @ 65mA input, 5VDC aux. output (regulated)
- Displays up to 308 characters (11 lines of 28)
- 12 x 18 pixel character pattern
- Asynchronous serial input only @ 9600bps
- Size: 3.5"L x 1.1"H



SALE

Part No.	Mfr. Cross Ref. No.	1	10	25
162051CD	BOBII	\$69.95	\$62.95	\$56.65

SMK RF Modulator

- Output frequency: NTSC Ch. 3/4, switch selectable
- 12VDC RF modulator
- Operating voltage: 12V @ 50mA max.
- RF output impedance: 75Ω (F-type connector)
- Video modulation: 1.0V p-p
- Audio FM deviation: 1.4V p-p
- PC connections: solder tab connectors
- Size: 1.7"L x 1.7"W x 0.7"H • MFG. #: WMN2144-01



Part No.	Description	1	10	50	100
141639CD	RF modulator	\$4.95	\$4.49	\$3.59	\$2.65

30-Day Money-Back Guarantee

SONY® Color CCD Camera

Sony Chipset

- 1/4" Sony super HAD CCD sensor
- NTSC system with 510(H) x 492(V)
- Furnished mini lens: 3.6mm
- Minimum illumination: 0.5 lux @ F2.0
- Signal to noise ratio: >48dB • 330 TV lines
- Supports these functions: auto electronic shutter (AES), auto iris control (AIC), auto gain control (AGC), auto white balance (AWB), back light compensation (BLC) and flicker less (FL)
- Video drive iris control; high/low switchable auto gain control; on/off backlight compensation
- Internal, negative synchronous system
- Video output: 1Vp-p; 75Ω



Requires: 12VDC @ 120mA power supply (recommend P/N 100095CD, pg 55)

Includes: Power/signal cable & mounting hardware

Part No.	Description	1	10
213436CD	Enclosed color camera	\$179.95	\$161.95

Mini Enclosed Color NTSC Camera

- 1/4" CCD Sensor
- 350 horizontal TV lines
- 1 lux/F2.0
- Electronic shutter: up to 1/120,000 sec.
- NTSC system with 512(H) x 492(V)
- Scanning system: 2:1 interlace
- Signal to noise ratio: 48dB • Lens: 3.7mm/F2.0
- Video output: 1Vp-p, 75Ω • FOV: 92°
- Size: (enclosure) 1.3"L x 1.1"W x 0.9"D
- Weight: 0.3 lbs. • Two-year warranty



Requires: 9VDC – 12VDC @ 500mA power supply (recommend P/N 100853CD, pg 55)

Includes: BNC/Power cable and mounting hardware

Part No.	Description	1	10
215423CD	Mini enclosed camera	\$129.95	\$119.95

Color Interline Camera

Water Resistant with Adjustable Mounting Bracket

- EIA format
- 1/3" CMOS image sensor
- EIA format: 512(H) x 492(V)
- 330 horizontal line resolution
- 2:1 scanning interlace system
- 5 lux sensitivity
- Video output: 1V p-p; 75Ω • 6mm lens/F2.0
- S/N ratio: 40dB • FOV: 530
- Electronic shutter: 1/60 – 1/1,200 sec.
- Connectors: 1 standard RCA female jack for video, and in-line 2.1mm power-plug connector for power supply • Size: 2.6"L x 0.9"Dia.



Includes: Adjustable mounting bracket, instruction sheet and 9V @ 100mA power supply

Part No.	Description	1	10
185017CD	Color camera	\$99.95	\$89.95

Color Camera Board

NTSC Format

- 1/3" CCD image sensor
- 5.0 lux • FOV: 92°
- 3.6mm lens/F2.0 • 330 TV lines
- Low power consumption
- Automatic exposure, gain and white balance
- Size: 1.0"L x 0.9"W x 1.1"H



Part No.	Description	1	10
171011CD	Camera board	\$73.95	\$66.59

SONY®

Black & White Low-Light Camera

Sony Chipset

- Signal to noise ratio: >48dB
- Requires 12V power source (not included)
- 6" wires with 4-pin Molex-type keyed connector
- EIA system 537(H) x 505(V)
- Composite output with 420 line resolution • Lens: 3.6mm
- Shutter speed: 1/60 - 1/1000 • FOV: 92.6°
- Video output: 1.0Vpp composite video/75Ω
- Size: 1.3"L x 1.3"W x 1.0"H • One-year warranty



Part No.	Description	1	10	25
150931CD	Camera board	\$89.95	\$80.95	\$71.95
159071CD	8mm lens 38.6°	17.95	17.10	16.25

Black & White Camera

EIA Format

- 1/3" CCD image sensor
- 510(H) x 492(V) • S/N ratio: 46dB
- Horizontal resolution: >350 lines
- Scanning system: 2:1 interlace
- Sensitivity: 0.7 lux/F2.0
- Video output: 1Vp-p, composite video 75Ω
- Power supply: 12VDC (recommend P/N 162996CD, pg 54) • Size: 1.3"L x 1.3"W x 1.2"H
- Power consumption: 110mA • FOV: 92°
- Electronic shutter: 1/125,000 sec. (linear)



Part No.	Description	1	10
171029CD	Camera board	\$47.95	\$42.95

10" Black & White Security Monitor with Audio

- EIA format
- 9" viewable screen
- Resolution: 700 line
- Push down front panel for vertical size, brightness, volume, and contrast adjustments, power switch
- Horizontal frequency, focus and sub-brightness adjustment, impedance input switch, 1 BNC female & 1 RCA jack for audio/video input/output
- Input voltage: 120VAC @ 60Hz (2-prong 5' cable)
- Size: 9.3"W x 12"D x 9.1"H • Weight: 15 lbs.



Includes: Manual

Part No.	Description	1	10
192719CD	10" black & white monitor ..	\$119.95	\$95.95

Audio/Video Adapters (CAT 5 UTP)

- Converts impedance of video/audio signals to 100Ω for transmission over CAT 5 UTP cable
- Supports both NTSC or PAL video signals
- Built-in impedance matching device and filter for video and audio signal transmission
- Use with existing premises wiring and wall jacks for easy and cost effective installation
- Video transmission distance: 1000' color/2000' B/W
- 210471CD: Signal pair: video (BNC), CAT pair 1 (RJ45)
- 220880CD: Signal pairs: video (BNC), CAT pair 4 (RJ45); audio 1 (RCA); CAT pair 3 (RJ45); audio 2 (RCA), CAT pair 2 (RJ45)



Includes: 1 RCA to BNC adapter & 2 mounting screws

Part No.	Connector Type	1	10
210471CD	BNC/RJ45	\$29.95	\$26.95
220880CD	BNC/RCA/RJ45	42.95	38.95

2.4GHz Wireless Fully Automatic Color CCD Camera

With AES/AI Video Drive

- Auto electronic shutter (AES): 1 to 1/100,000 sec.
- Auto iris (AI) control video drive switchable
- Color; NTSC format; 2.0 lux/F1.2
- 380 TV line resolution
- S/N ratio: more than 48dB
- Scanning system: 2:1 interlace
- 1/3" CCD interline sensor
- 512(H) x 492(V)
- Video output: 1Vp-p / 75Ω
- Impedance output: 75Ω typical
- LED power "ON" indicator at rear panel
- Size: 4.0"L x 2.2"W x 2.0"H • Weight: 2.1 lbs.

Includes: 15VDC power supply, antenna, mounting bracket and manual

208645CD: Auto Iris Lens

- Auto iris direct drive
- FOV: 46° • Aperture: ±4F = 1.4 ~ 6.4
- Use with receivers 169631CD or 192866CD (pg 197)

Part No.	Description	1	10
174810CD	Color camera	\$219.95	\$195.95
208645CD	Auto Iris lens	69.95	62.95



174810CD:
Shown with Lens
P/N 208645CD
(not included)

4-Channel 2.4GHz Wireless Audio/Video Receiver and 10mW Transmitter

Make your camera wireless up to 495 feet!

- Transmission range: 495' (150M outdoors); 198' (50M indoors)
- 4-channel switch selectable on transmitter
- Output power (transmitter): 10mW
- Output impedance: 50Ω typical
- Video input: 1Vp-p composite
- Audio input: 2Vp-p max.
- RCA jacks for audio and video connectors

Receiver:

- Video loss detection and freeze channel
- Non-volatile memory protects system set-up from power loss
- Mute and alarm trigger port
- Size: (transmitter) 4.5"L x 3.2"W x 1.0"H
- Size: (receiver) 6.5"L x 5.5"W x 1.4"H
- Weight: 1.8 lbs.

Includes: RCA cable, 12VDC@500mA adapter, RCA to F connector adapter (receiver unit only)

Part No.	Description	1	10
192858CD	4-channel transmitter	\$89.95	\$79.95
192866CD	4-channel receiver	124.95	112.95



For RCA and BNC Connectors and Cables see pages 119, 130 & 131.



New Camera Window Mount see page 223

2.4GHz SMA RF Antenna

Unidirectional

- For use with 2.4GHz cameras, transmitters, and receivers
- Gain: 3dB • SMA male • Size: 3.6"L

Part No.	Description	1	10
179864CD	2.4GHz antenna	\$15.95	\$14.35



4-Channel 2.4GHz Wireless Audio/Video Transmitter System

CCIR NTSC, PAL, EIA Format

- ISM band: 2.4-2.483GHz
- Four selectable channel transmitter and receiver
- Audio response: 20Hz-20kHz
- Antenna mode: dipole (omnidirectional)
- Video output: 1V p-p/75Ω composite video
- RCA jacks for audio/video connectors
- Weight: 3.3 lbs.

Includes: Two 12VDC @ 500mA w/ 2.1mm x 5.5mm center positive plug, and patch cables

Transmitter: Size: 3.5"L x 2.5"W x 1.1"H

Receiver: Size: 5.1"L x 4.0"W x 1.0"H

Part No.	Description	1	10
169631CD	4-ch. wireless system	\$149.95	\$134.95



2.4GHz Wireless Antenna Booster

Extend Video Transmitting Distance

- Output power: 700mW (±10%)
- Input power: 10mW - 60mW
- Consumption 350mA
- Impedance output: 50Ω typical (to antenna)
- Frequency: 2400 - 2500
- Size: 2.2"L x 2.0"W x 0.8"H

Includes: 9VDC @ 800mA power supply

Part No.	Description	1	10
215175CD	Antenna booster	\$199.95	\$179.95
179872CD	Wireless extension cable	10.99	9.89



Camera Mounts & Housings

Mini Indoor Pan & Tilt Mechanism

Continuous Pan

- Automatic scanning: 0° - 355° angular travel; pan clockwise and counter-clockwise
- Manual tilt: 0° - 90°
- Pan speed: 5"/sec.
- Maximum load: 4.4 lbs.
- Power consumption: 1 Watt
- Size: 2.5"Dia. x 2.4"H
- Warranty: 2 years continuous use • Wt.: 0.4 lbs.

Includes: 24V @ 150mA power supply, wall mount bracket and mounting hardware

Part No.	Description	1	10
215407CD	Mini pan/tilt	\$49.95	\$44.95



Camera not included

Outdoor Metal Camera Enclosures

- Plate glass: 3mm thick
- Outdoor use
- **170931CD: without heater**
- Clear window area: 2.5"W x 2.3"H
- Max. camera size: 4.0"L x 2.4"W x 2.4"H
- Size: 16.0"L x 4.9"W x 4.9"H • Weight: 2.8 lbs.
- **170940CD: w/ heater (keeps optics from fogging)**
- Clear window area: 3.5"W x 3.1"H
- Max. camera size: 6.5"L x 3.2"W x 3.2"H
- Size: 11.0"L x 3.6"W x 3.6"H • Weight: 6.8 lbs.

Part No.	Description	1	10
170931CD	Camera housing	\$29.95	\$26.95
170940CD	Camera housing w/ heater	69.95	62.95



Mounting Brackets for Enclosed Camera

- Material: plastic
- Base mounted w/ 3 screws
- Swivel angle: 360°
- Tilt angle: 90°
- For use w/ enclosed cameras (P/Ns 150404CD and 169404CD, pg 198)
- **171002CD:** • Color: ivory
- **170982CD:** • Color: white

Part No.	Mfr. Cross Ref. No.	Ht. (in.)	1	10
171002CD	15-B002L	6.4	\$5.49	\$4.95
170982CD	15-B004	2.0	8.49	7.65



171002CD 170982CD
• Max load: 11 lbs.
• Max load: 6.6 lbs.

Indoor Pan/Tilt Mechanism

Continuous Pan

- Angular travel pan: 355°
- Angular travel tilt: ±60° (up/down)
- Input voltage: 115VAC
- Externally adjustable limited switch
- Pan speed: 6"/sec.
- Tilt speed: 3"/sec.
- Maximum load: 11 lbs. • Weight: 4.6 lbs.
- Size: (overall) 6.2"W x 5.4"D x 7.5"H

Part No.	Description	1	10
179899CD	Pan/tilt mechanism	\$199.95	\$179.95



PANAVISE 12 Version Camera Mounting Kit

A unique component system allows you to build one of twelve versions for today's smaller cameras. Quality ball housing provides 120° tilt and 360° camera rotation. Shafts are 1/8" dia. Vinyl cover adds a finished and professional look.

- Wall ceiling and T-Bar clip mounting
- Shafts: 2" (50.8mm), 4" (101.6mm) or 6" (152.4mm) long
- Knob & set screw adjustment CCTV mounts

Part No.	Product No.	Description	Price
224354CD	845-246	CCTV mounting kit	\$16.95
224389CD	860	Tri-foot base	7.49
224371CD	861	Square base	6.29
224362CD	862W	J-Box plate	8.95



Black & White CCD Camera with 6" Monitor

Camera: EIA Format

- 512(H) x 492(V)
- 1/3" CCD image sensor
- 380 TV line resolution
- 6 IR LED light for view in the dark application
- 15.734kHz horizontal synch. frequency
- 2:1 interlace scanning system
- 1/100,000 second electronic shutter
- 3.6mm lens with F2.0 • S/N ratio: 48dB
- Video output: 1Vp-p, 75Ω
- Audio output: 2Vp-p, 50Ω maximum • 0 lux at 2M
- BNC connector for video & RCA connector for audio
- Power supply: 12-15V @ 130mA • FOV: 92°
- Size: 2.2"W x 2.8"D x 2.1"H



Includes: Camera bracket

Monitor: EIA Format

- 6" 2-channel flat screen monochrome monitor
- Vertical hold, brightness and contrast adjustment knobs at rear of monitor
- Size: 6.7"W x 7.2"D x 5.2"H • Weight: 7.7 lbs.

Includes: 20M audio/video cable, manual and 15V @ 1A center positive power supply

Part No.	Description	1	10
170616CD	Camera w/ monitor	\$159.95	\$143.95

Mini Dome Color Camera

NTSC Format

- Perfect for ceilings
- 1/4" CCD image sensor
- 512(H) x 492(V)
- 330 horizontal line res.
- S/N ratio: 46dB
- 15.73kHz horizontal synch. frequency
- Scanning system: 2:1 interlace
- Up to 1/96,000 second electronic shutter
- 3.6mm lens with F2.0
- Video output: 1Vp-p, 75Ω
- Power supply: 12VDC @ 160mA (recommend P/N 162996CD, pg 54)
- 2 lux/F2.0 • FOV: 92°
- Size: 3.5"Dia. x 2.3"H



Includes: Mounting hardware

Part No.	Description	1	10
171037CD	Mini-dome camera	\$139.95	\$125.95

Color Camera with Audio Microphone

NTSC Format

- Pick-up device: 1/4" CCD image sensor
- FOV: 92°
- Picture elements: 512(H) x 492(V) lines
- 330 TV line resolution
- Minimum illumination: 2 lux
- Horizontal sync. frequency: 15.734kHz
- Vertical frequency: 60Hz
- Scanning system: 2:1 interlace
- Video output: 1V p-p, 75Ω
- Audio output: 2V p-p max.
- Lens: 3.8mm/F2.0
- Size: 2.9"L x 2.1"W x 2.0"H • Weight: 0.3 lbs.



SALE

Requires: 12V regulated power supply (recommend P/N 162996CD, pg 54)

Part No.	Description	1	10
169404CD	Enclosed camera w/ audio	\$119.95	\$109.95

Color and B&W Cameras

- 1/3" Panasonic CCD image sensor
- Image size: 4.82mm (H) x 3.64mm (V)
- More than 380TV lines horizontal resolution
- 15.734kHz synchronous frequency
- Scanning system: 2:1 interlace
- S/N ratio: more than 46dB • FOV: 42.6°
- BNC connector for video
- Video output: 1Vp-p; 75Ω
- Size: 4.0"L x 2.2"W x 2.0"H • Weight: 0.9 lbs.
- **171256CD: B&W** • 0.3 lux
- 512(H) x 492(V) EIA signal format
- Auto iris: DC driver / AES / video driver switchable
- **171248CD: Color** • 1.0 lux / F1.4
- 512(H) x 492(V) NTSC signal format
- Auto iris: DC driver / video driver switchable



171248CD

Requires: 12VDC @ 140mA power supply (recommend P/N 162996CD, pg 54)

Part No.	Description	1	10
171256CD	B&W CCD camera	\$109.95	\$99.95
171248CD	Color CCD camera	224.95	201.95
208645CD	Auto Iris lens	69.95	62.95

Solar Outdoor Security Light

Dark spots around your business, house or neighborhood are vulnerable to vandalism or burglary.

To protect your property, equip it with our new outdoor security lights and motion sensors. All you need are simple tools to mount the unit to the wall. No complicated wiring or electrician needed. The built-in batteries are rechargeable by sunlight, so if the main power goes out you still have security lighting. The solar panel, which has a 12' cord, can be positioned for optimum light exposure.



- Lights up to 60 times on a single charge
- Charges by day, lights by night
- Complete with built-in motion detector, rechargeable battery and bright halogen light
- Easy to install • Weight: 7.1 lbs.

Part No.	Product No.	Description	1	10
219580CD	223	Security light	\$79.95	\$74.95

Wall Mount Key Lockboxes

Quick, easy way to prevent lockouts and easy access to your residence or business establishment. A safe alternative to hiding a key under your mat or flowerpots. This stylish keybox can be attached securely to a wall, in plain view, and can hold up to 5 keys. The easy pushbutton combination lock with protective cover prevents your keys from being stolen and from the harsh elements. Ideal for business for access to secure areas like tool cages, construction sites, and computer room as well as residential or vacation home access for family, friends, and service providers, like cleaning and pool service.



Part No.	Description	1	5
223933CD	Wall Mount, White	\$39.95	\$35.95
223941CD	Wall Mount, Clay	39.95	35.95

Auto/SUV/Commercial Vehicle Permanent Lockbox Key

Never get locked out of your automobile again! A better solution for those magnetized-type key storages. With StorAKey keep your spare keys safely locked away. Pays for itself with just a one-time loss of keys or for a locksmith to open your automobile or commercial vehicle. Ideal to store keys for commercial use where multiple people use forklifts, trucks, or heavy-duty construction equipment. Save money on long term airport parking by having a family or friend park your vehicle in the airport parking lot a day before you arrive. Keys are easily accessible in this strong, weatherproof casing made of zinc alloy that never rusts or deforms. The case also has an interlocking faceplate that prevents unauthorized entry, spring steel clamp, and a weather tight protective face cover. Pushbutton keys are easy to operate or to reset combinations.



Part No.	Description	1	5
223925CD	Auto Lockbox	\$39.95	\$35.95

Monitor/TV Wall Mount Brackets

- 95° swivel
- Assembly required
- Requires unit base to be mounted securely to wall stud
- Wall mount screws not included
- Supports up to 66 lbs. • Weight: 9.0 lbs.



Part No.	Description	1	10
181817CD	12"-18" TV wall mount	\$29.95	\$27.95

Mini Alarm Siren

- Sound pressure: 108dB
- Output frequency: 3000Hz
- Rated: 2-12VDC @ 300mA
- Adjustable mounting plate
- 16" color coded connector wires, tinned • Size: 2.8"Dia. x 2.5"L



Part No.	Description	1	10	50
148152CD	Alarm siren	\$7.95	\$6.79	\$5.09

Night Vision Infrared Lighted Camera

EIA Format

- Adjustable camera lens
- Auto iris controlled
- Built-in voltage regulator
- Horizontal sync. frequency: 15.734kHz
- 6 infrared LEDs for night vision
- Scanning system: 2:1 interlace
- Video output: 1Vp-p; 75Ω
- Audio output: 2Vp-p max.
- 380 TV line resolution
- FOV: 92° • 0.1 lux with F2.0 • Lens: 3.6mm
- Matching conn.: RG59 BNC (P/N 71271CD, pg 131)
- Size: 2.9"L x 2.0"W x 2.0"H • Weight: 1.2 lbs.



SALE

Includes: 12VDC @ 500mA power supply and wall mounting bracket

Part No.	Description	1	10
150404CD	Infrared lighted camera	\$119.95	\$109.95

Never Be Without Light With Our Solar Lantern

The perfect light source for emergency situations. You will never run out of light with this lantern. This rechargeable lantern features a three-way power system: solar power – charge the built-in battery during the day for night time use; 3-D size alkaline batteries; or AC/DC adapter that can also charge the built-in battery. Designed for indoor or outdoor activities with three unique features: solar fluorescent light, solar blinking light and solar searchlight.



- 8-10 hours in full sun for a fully-charged battery
 - Up to 3 hours of operation when using flashlight and fluorescent light simultaneously; 10 hours of blinking light; 8 hours of torch light; 4 hours of fluorescent light
 - Size: 5.6"W x 2.1"D x 11.5"H • Weight: 1.8 lbs.
- Includes:** Strap and spare bulbs

Part No.	Description	1	10
219598CD	Solar rechargeable lantern	\$69.95	\$64.95

Jump Start with 260 PSI Air Compressor

Power & air where and when you need it!

Worried about getting stranded on the road? Not when you pack your self-contained battery starter and air compressor! Just clamp the cables onto your battery terminals and start your car. Pump up a flat with the 260-PSI air compressor and drive to a service station to get it fixed. No phone calls. No waiting. No putting yourself at the mercy of strangers. But that's not all. You also get a built-in worklight and 12VDC car-type outlet that can power TVs, coolers and cellphones for up to 50 hours. Recharge the jump-starter from an AC outlet or your car's cigarette lighter using the AC and DC adapters.



Recharge the jump-starter from an AC outlet or your car's cigarette lighter using the AC and DC adapters.

- 12VDC supply with 400A crank/900A peak
- Rechargeable 17A hour sealed lead acid battery
- #4 AWG booster cables
- Cigarette lighter plug output with overload protection for running DC appliances provides up to 50 hours of use
- 3.6W built-in light
- Color coded battery meter and battery test switch
- ABS high-impact body with an oversized carry handle
- Weight: 23 lbs.

Includes: DC-to-DC power cord and 120V adapter

Part No.	Description	1	10
223888CD	Jump start w/ air compressor	\$49.95	

Security Camera and Decoder

The bulb looks like a standard fixture, but it really contains a miniature camera and transmitting encoder in a sturdy, weatherproof enclosure. Simply screw the bulb-camera into any outdoor light socket, plug the mini-receiving decoder into any TV in your house, and you are ready to watch the piece-of-mind channel. Installation truly couldn't be easier. You'll get a clear birds-eye view of your security perimeter without fishing wires through walls, drilling holes, mounting antennas, or changing and checking batteries. While your other outdoor lights illuminate the scene, the SecureView outdoor camera provides the picture. You'll be glad you have it.



It's a camera!

Send video signals to over 2000' of 110VAC lines

- 85° viewing angle, from 6" to optical infinity
- Viewing range up to 100 yards in daylight
- Built-in infrared circuitry will see in total darkness up to a maximum of 30'
- NTSC composite transmitter; NTSC composite and RCA connector receiver
- Transmitter size: standard flood lamp housing
- Receiver size: 2.5"W x 2.0"D x 3.8"H

Part No.	Description	Price
219379CD	Outdoor camera and decoder	\$199.95

World Band Portable Solar Radio

This portable solar radio is an essential for emergency preparedness when you need to be updated about what is happening in the news, weather and police beat. With the InfoMate® radio you will never depend on batteries again. The InfoMate® radio can be powered and recharged by AC adapter, cigarette lighter adapter, sunlight or built-in hand generator. Keep one on your window sill or plugged in if you happen to live in an area subject to severe weather conditions, earthquakes, floods, fires, etc. You will always have access to the latest emergency information.



- 11 bands: AM (530-1700kHz, AM std.)/FM (88-108MHz), TV1 (Channel 2-6), TV2 (Channel 7-13). Aircraft (112MHz, commercial air), VHF (145-175MHz, taxi/police/business radio), National Weather Band Service, SW1-SW4
- Guide book developed in association with the National Weather Service
- 4 power sources: AC adapter, vehicle adapter, solar power (rechargeable batteries) and dynamo generator
- Low battery LED indicator tell you when your battery charge level is running low
- Weight: 1.0 lb.
- Tuning LED indicator helps locate situations on your scale
- Size: 8.6"W x 3.0"D x 5.3"H

Includes: High quality earplugs, 12V car cigarette lighter charging cord, AC/DC wall adapter (UL approved), a pack of 4 Ni-Cad batteries and manual

Part No.	Product No.	Description	1	10
219299CD	837-D	World band radio	\$69.99	\$66.49

Alc Alert Breathalyzer

Be safe and insure you do not lose your driver's license

No one gets behind the wheel intending to wreck lives. But each year thousands do just that when they misjudge the amount of alcohol in their system. Some get arrested and lose their license, sending their families into turmoil. Some cause accidents with tragic results. But now, you can stop putting yourself and others at risk. Alc Alert lets you quickly and discreetly check your blood alcohol level before you drive. No bigger than a cigarette lighter, this sensitive instrument uses gas sensor digital technology to measure blood alcohol level (BAC) from .0% to .12%, well past the legal limit in all states. A backlit LCD panel and audible alerts guide you through the simple procedure. Just blow as if cooling soup on a spoon. When you hear 3 beeps, stop and read the results.



- Compact design fits easily into your pocket, purse or day planner
- Backlit LCD makes it easy to read in low-light conditions
- Audible alert beeps when unit is ready and after breath sample registers
- "Smart Messages" alerts you with incomplete breath samples & saturation levels
- Operates for over 300 uses on 2 AAA batteries

Includes: Protective pouch and batteries

Part No.	Product No.	Description	Price
222332CD	837-D	AlcAlert	\$49.95

Bushnell Night Vision Monocular

Like the infrared goggles worn by the U.S. military, Bushnell Night Vision lets you see them, but they can't see you.

See in the dark without disturbing or alerting others. Night Vision Monocular uses military-grade image intensification technology to let you see clearly for up to 300 feet, even in pitch blackness. It's perfect for campers, hunters, hikers and wildlife enthusiasts... essential for surveillance and search-and-rescue work. Night Vision collects and amplifies the minute amount of light that exists even in what we perceive as total blackness. It converts the light into electrons that strike a phosphor screen, producing a detailed image just the way your TV does. High-speed f1.5 objective lens with 2.4X image magnification. FOV of 79 feet at 100 yards. Weighs 17 oz. with 2 AA batteries (included). Comes with roomy padded carry case with adjustable shoulder strap.



Part No.	Description	Price
219694CD	Night Vision Monocular	\$199.00

Order Anytime 24x7x365

Phone 1-800-831-4242 Fax 1-800-237-6948

Online www.Jameco.com

BASIC Stamps **SALE**

BASIC Stamps are small computers using a variation of BASIC called PBASIC to control execution of many applications, such as robotics, radio-controlled interface of a digital camera, industrial pallet stacker, health monitoring systems, and much more. The BS1-IC has 8 I/O lines, while the BS2-IC has 16 I/O lines which can be connected directly to buttons, LEDs, registers, and many other TTL level devices. Each allows you to store data in the EEPROM before downloading a BASIC program.

See page 98 for Serial LCD Modules

Includes: Embedded BASIC plus instruction sets; basic interpreter, EEPROM (non-volatile), a resonator and 5V regulator

Specifications:	127693CD	130892CD
EEPROM	256 bytes	2048 bytes
RAM	16 bytes	32 bytes
Cur. Draw @ 5V	2mA run/20µA	8mA run/100µA
Microcontroller	PIC16C56	PIC16C57
Program speed	2000/sec.	4000/sec.
# of I/O Pins	8	16 + 2 serial
Package	14-pin SIP	24-pin DIP
Volts Required	5-15VDC	5-15VDC
Size	1.4"L x 0.4"W	1.2"L x 0.6"W

Part No.	Parallax No.	1	10
127693CD	BS1-IC	\$33.95	\$32.29
130892CD	BS2-IC	\$48.95 45.95	41.95

BASIC Stamp® 2 Starter Kit with BS2-IC (27203) **SALE**

Design your own project today using this BASIC Stamp kit. Includes the super carrier board, software, manual and programming cable. BASIC Stamp 2 can be connected directly to buttons, LEDs, registers and many other TTL devices.



Part No.	Parallax No.	1	10
140071CD	27203 Kit	\$149.95 \$139.95	\$132.95

See the yellow and green highlighted items.

Special Jameco Values!

Sale details are on page 4.

Parallax Books See Page 214



50MHz BASIC Stamp 2SX Module

High-speed version of BS2-IC with additional RAM and EEPROM.

- Microcontroller: Ubicom SX28AC
- Program execution speed: 10,000 instructions/sec.
- EEPROM program size: 8 x 2k bytes, 4,000 instructions
- Current draw @ 5V: 60mA run/200µA sleep
- Number of I/O pins: 16 + 2 serial
- RAM size: 32 bytes
- Size: 1.2"L x 0.6"W

Part No.	Parallax No.	1	10	50
159775CD	BS2SX-IC 24-pin	\$58.95	\$55.95	\$53.19

BASIC Stamp 2P Modules

In addition to the BS2-SX (above) features, includes new commands for HD44780 compatible LCDs, Dallas Semiconductor 1-wire and Philips I2C parts.

- Voltage requirements: 5-12VDC
 - Program execution speed: 12,000 instructions/sec.
 - RAM size: 38 bytes (12 I/O, 26 variable)
 - Scratch pad RAM: 128 bytes
 - EEPROM program size: 8 x 2k bytes, 4,000 instructions
 - Current draw @ 5V: 40mA run; 400µA sleep
- 184911CD: Size: 1.2"L x 0.6"W x 0.4"H
 184920CD: Size: 2.0"L x 0.6"W x 0.4"H
 • Number of I/O pins: 16 + 2 serial
 • Number of I/O pins: 32 + 2 serial

Part No.	Parallax No.	1	10
184911CD	BS2P24-IC 24-pin	\$78.95	\$71.95
184920CD	BS2P40-IC 40-pin	98.95	89.95

BS2P Professional Starter Kit

Provides the engineer with all the parts required to get started with the BSP2 microcontroller. The kit includes a selection of components and ready-to-run source code that will help master some of the exciting new features of the BSP2.

- Includes:** Programming manual, BS2P demo board, BS2P-24 microcontroller, DB9 (serial) programming cable, PCF8583 chip, 32.678kHz crystal, 24LC32 serial EEPROM, DS1822 thermometer, (3) 4.7K resistor, jumper wires.

Part No.	Parallax No.	1	10
202323CD	27235 kit	\$194.95	\$174.95
202331CD	BS2P40 adapter	24.49	21.95

BASIC Stamp 2 OEM Kit

A through-hole version of the popular BASIC Stamp modules.

- 20-pin SIP, standard 0.1" spacing
- PC board includes labeled component locations with visible traces between parts
- PBASIC interpreter and EEPROM are socketed to allow for replacement
- Programmed using PBASIC DOS or Windows® editor just like the BASIC Stamp modules

Includes: PBASIC interpreter, EEPROM, resonator, DB-9, resistors and transistors

Part No.	Parallax No.	Price
183071CD	27291 BASIC® Stamp 2 kit	\$48.95

Stamp Works Kit

This all-in-one kit takes you beyond theory, into a well-written collection of 32 experiments that will teach you first class BASIC Stamp programming. You'll learn to get the most out of the BASIC Stamp and to increase its versatility by connecting to popular active and passive components.



Includes: Manual, BASIC Stamp Experiment Board, BS2-IC, 2x16 parallel LCD with custom cable, digital multimeter with 2 probes, wire cutter/stripper/pliers, three 100' rolls 22 AWG wire, screwdriver kit, photoresistor, 555 timer, 8-bit serial-to-parallel and 8-bit parallel chips, Dallas Semiconductor 1620 digital thermometer and real-time clock with 32.768MHz crystal, National Semiconductor ADC0831 8-bit A/D converter, Maxim 7219 8-digit LED display driver, National Semiconductor LM358 op-amp, stepper motor, servo, power supply, resistor assortment, capacitors, serial cable, CD-ROM and plastic box for parts

• Weight: 4.0 lbs.

Part No.	Parallax No.	1	10
184946CD	27297	\$348.95	\$314.95

BASIC Stamp Prototyping Boards

Optional boards for BS1-IC, BS2-IC and BS2SX-IC Stamps.

- Easy use of Stamp with prototyping area, 9-volt battery clips, I/O header, reset button, and programming connector
- 164726CD
 130921CD: Use w/ P/N 130892CD, far left
 • Size: 3.0"L x 2.6"W
 164726CD: Use w/ P/Ns 127693CD & 130892CD, far left and P/N 159775CD, above
 • Size: 4.0"L x 3.0"W

Part No.	Parallax No.	1	10
130921CD	27120	\$27.95	\$24.95
164726CD	27130	48.95	46.55

In-System Programming Kit

This unique development tool programs Scenix SX chips in-system and performs in-circuit source-level debugging. Supports every Scenix Semiconductor chip that is commercially available.

- Includes SX Key software, SX Tech Board, 2 SX 28AC/DP 50 MIPS chips, 1 Murata 50MHz resonator, printed manual, CD ROM, power supply and serial cable
- DB-9 serial connector connects to RS-232 port using serial cable
- 4-pin connector on other side of tool plugs into the SX's Vss, Vdd, OSC1 and OSC2 pins
- Windows® 95/98/NT compatible
- Size: 0.5" x 1.7"

Part No.	Parallax No.	1	10
176583CD	45180	\$174.95	\$154.95

50MIPS SX Microcontroller

Part No.	Parallax No.	1	10
162931CD	SX28AC/DP (28-pin DIP pkg) ...	\$5.49	\$5.25

Quickwriter MCU Programmer

Tech Tools

- Programs 4 devices as quickly as a single device when using a gang adapter
- Supports In-Circuit programming with the included cable
- Auto incrementing serial numbers in code or data locations
- Supports existing programming adapters
- Reports individual failures when programming multiple devices
- Enable/disable each programmable area of the MCU
- Select manual programming tasks or "Auto Run"
- Supports 12C5XX, 12C6XX, 12CE5XX, 12CE6XX, 14000, 16C5X/XX, 16C6X/XX, 16C7X/XX, 16C9XX, 16CE6XX, 16FXXX, and 18FXXX series
- Documentation on CD-ROM
- Weight: 1.6 lbs.



209040CD

SALE



133911CD

Requires: IBM PC or compatible, serial port and Windows® operating system

Includes: Quickwriter programming module, DB9 M-F cable, 12VAC @ 1A adapter, documentation and software on CD-ROM

Part No.	Description	1	10
209040CD	Quickwriter programmer	\$198.95	\$178.95
209314CD	18/28 pin ZIF adapter	68.95	61.95
133911CD	40 pin ZIF adapter	44.95	41.29
209293CD	4-gang 18-pin ZIF adapter	198.95	178.95
209306CD	4-gang 28/40-pin ZIF adtr	198.95	178.95

Motor Mind B Module

Motor control supports one or two line serial communication stream. DC motors with operating voltages as great as 30VDC and continuous currents of 2A can be controlled. An on board frequency counter has a range of 0-65,528Hz. Motor speed (254 steps) and direction can be controlled. Motors with tachometers or encoders may make use of the automated speed control function.



Part No.	Description	1	10
143802CD	9-pin motor mind B module	\$28.95	\$26.95

Motor Mind C Single or Dual DC Motor Controller

The Motor Mind C has been designed to function as a versatile DC motor control system. The module is ideal for use in small robotics projects for controlling two-wheel axles. The motor connections may also be tied in parallel to control a single larger motor.



- Control 10-24V brushed DC motors
- Maximum continuous current 4.0A
- 40-pin DIP socket package
- Single or dual independent motor control options
- Over-current and over-temperature protection
- Serial control of 10-bit PWM signal
- Alternative analog control (0-5VDC) of PWM signal
- Alternative R/C (1-2ms) pulse control of PWM signal

Part No.	Description	1	10
215546CD	Motor mind C	\$58.95	\$53.95

Parallax's "Stamps In Class" Series Kits

PARALLAX 7

Enabling Students to "Micro-Control" the World

Learn BASIC Stamp programming essentials from the experts. Each kit combines an educational book with the components needed to cover robotics, process control and microcontroller interfacing. The program emphasizes creative PBASIC programming in the classroom. For use with the "Board of Education" below.

More Training Boards on pages 112-115

Robotics

Build a BOE-BOT by adding a chassis, servo motors, power supply and proximity sensor to your Board of Education (right). Experiments cover basic programming and servo control, sensor interfacing using an infrared LED and receiver, light following, and communication between BOE-BOTs.



- Experience: moderate
- 84 piece kit with book

Requires: BS2 starter kit (P/N 140071CD, pg 200)

Part No.	Parallax No.	1	10
170131CD	28154	\$134.95	\$121.95

"Board of Education" SALE

The BOE was designed in coordination with Parallax's educational customers to teach microcontroller programming and interfacing.



- Mechanically interlocked power supply to prevent dual connection of wall-pack and 9-volt battery
- DB9 connector for BS2-IC programming and serial communication during run-time
- P0 - P15 I/O pins, Vdd and Vss connections brought adjacent to 2" x 1-3/8" breadboard area
- Traces on top of the board show connections between BS2-IC and breadboard connections

Includes: Set of ten 10 color-coded 22 gauge wires

Part No.	Parallax No.	1	10
162536CD	28150	\$54.95	\$49.95
202331CD	BS2P40 adapter	24.49	21.95

Micro PID Position Controller (UPID)

The Micro PID position controller is a stand-alone motor position controller for use with small DC motors. This device provides 32-bit position control of DC motors with quadrature encoders. Four modes of operation allow for use in a wide variety of applications.



- Up to 2A continuous current, 10A peak
- 6-30VDC brushed motors
- Direct position control via 38.4Kbps, 19.2Kbps, or 9.6Kbps serial interface
- Stores up to 16 trapezoidal profile segments, and 3 PID settings
- Analog position control mode (1024 positions) with offset and multiplier functions
- Velocity control mode
- Built in data-logging modes for trapezoidal or direct control operating modes
- Brake, reset, negative limit switch, and positive limit switch inputs
- Custom software simplifies programming & testing
- X4 or X1 quadrature signal decoding

Part No.	Description	1	10
215562CD	UPID position controller	\$79.95	\$75.95

ICON H-Bridge DC Motor Controller

The ICON H-Bridge provides easy connectivity to a wide range of medium power DC motors. An on-board microcontroller monitors current and temperature to provide protection if either trip point is exceeded. Various configuration registers may be monitored and programmed via the serial interface. These registers contain information such as the system load current, board temperature, over current trip point, over temperature trip point, and status information.



- Control up to 40V brushed DC motors
- Maximum continuous current 12A
- 2.5" x 1.9" PCB with 0.156" female sockets
- Allows logic level control of 4 N-channel MOSFETs
- Serial interface to on board H-bridge monitor
- Current measurement and adjustable current fuse settings
- Temperature measurement and adjustable temperature fuse settings
- Programmable, non-volatile fuse settings

Part No.	Description	1	10
215538CD	ICON H-bridge	\$99.95	\$89.95



Phone 1-800-831-4242
Fax 1-800-237-6948

Order Anytime 24x7x365

Online www.Jameco.com

Batteries and Accessories



Call for additional OEM PRICING – we carry major manufacturers.

Long-Lasting NiMH Batteries & Chargers



Lasts 10-30 times longer than Rechargeable Alkaline!

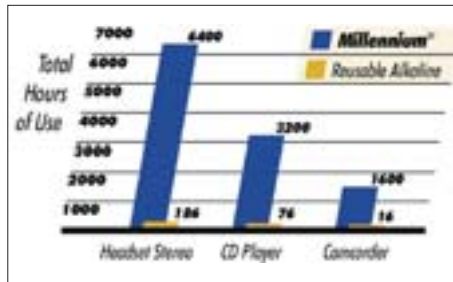

Why buy and throw away hundreds of batteries? Now you can reuse longer-lasting, money saving NiMH rechargeable batteries instead! They feature twice the power of NiCad batteries, so they're ideal for power-hungry devices like digital cameras and camcorders. The chargers below are specifically designed for NiMH batteries.

NiMH Batteries

Part No.	Description	1	10	25	100
185279CD	2x AAA, 700mAh	\$7.95	\$7.19	\$6.49	\$5.95
185261CD	4x AA, 1600mAh...	13.95	12.49	11.25	9.95
197000CD	2x C, 2300mAh	8.95	8.35	7.75	7.32
196998CD	2x D, 2300mAh	8.95	8.35	7.75	7.32
197018CD	1x 9V, 150mAh	9.95	8.95	8.15	7.29

NiMH Chargers

185308CD: AA charger with 4 AA batteries included

185295CD: AAA, AA, C, D and "9V" charger (Batteries not included)

Part No.	Description	1	10	25	100
185308CD	AA charger	\$21.95	\$19.95	\$17.95	\$15.95
185295CD	Universal chrgr	21.95	19.95	17.95	16.95

Eveready® Energizer® Alkaline Batteries



Energizer® and the Energizer Bunny® are registered trademarks of the Eveready Battery Company, Inc.

- Single use Energizer® alkaline batteries for heavy drain and frequent use applications
- Prepackaged: order in increments of 4

Part No.	Description	4	8	12
198707CD	AA	\$.82	\$.74	\$.68
198715CD	AAA	.55	.52	.48
198723CD	C	1.19	1.10	.99

Part No.	Description	1	4
198731CD	"9-volt type"	\$2.59	\$2.22
215845CD	D	1.95	1.69

Lithium, Silver Oxide, Zinc Chloride and Alkaline Batteries

Applications: personal computers, workstations, test equipment, feature telephones, copiers, fax machines, video scramblers/descramblers and remotes.



Part Number	Mfr. Cross Ref. No.	Description (V/Amp-hours/Dia.)	Battery Type	Terminals/Connection	Pricing			
					1	10	25	100
151087CD	AA	1.5V/0.7A-h/545"	Zinc chloride	Barrel pressure fit (standard AA)	\$2.25	\$2.23	\$2.21	\$1.99
151095CD	GF6F22	9.0V/0.3A-h/1.0"L	Zinc chloride	Standard 9V	1.25	.99	.79	.65
140783CD	357	1.55V/1.60A-h/454"	Silver oxide	Button cell	1.75	1.49	1.25	1.09
150965CD	840	4.5V/600mA-h	Alkaline	Battery pack w/ connector (Apple®)	9.95	8.99	8.09	7.25
198791CD	MN1604	9.0V/1.5A-h	Alkaline	"9-volt"	2.85	2.55	2.29	2.05
198758CD	CR2016	3V/80mAh	Lithium	Coin cell	.80	.75	.69	.61
14162CD	CR2032	3V/180mA-h/787"	Lithium	Coin cell (clock/memory)	1.25	1.00	.75	.53
11789CD	CR2325	3V/165mA-h/906"	Lithium	Coin cell (clock/memory)	1.95	1.75	1.49	1.25
33371CD	TL5101P	3.6V/.85A-h/579"	Lithium	Barrel w/ leads (clock/memory)	5.79	5.27	4.45	4.15
126754CD	TL5101S	3.6V/.85A-h/579"	Lithium	Half AA (Macintosh®)	6.95	6.29	5.65	5.09
33398CD	TL5104P	3.6V/1.9A-h/579"	Lithium	Barrel w/ lead (clock/memory)	5.95	5.49	5.19	4.85
146114CD	TL2100S	3.6V/1.9A-h/579"	Lithium	Barrel pressure fit (clock/memory)	6.95	6.29	5.65	5.09
33427CD	TL5242W	3.6V/1.9A-h	Lithium	Battery pack w/ plug (PC)	9.95	8.99	7.65	5.99
33443CD	TL5293W	6.0V/1.9A-h	Lithium	Battery pack w/ plug (PC)	9.95	8.99	7.19	5.39

Ni-Cad Batteries

Nickel-Cadmium batteries are rechargeable, sealed cells.

- Can be used for cyclic, trickle or float charge



Part No.	Mfr. Cross Ref. No.*	Description	Voltage	Amps	1	10	25	100
32627CD	S3300	AA	1.2V	650mA-h	\$1.95	\$1.75	\$1.49	\$1.25
126720CD	351FT	2-lead (pin)	3.6V	60mA-h	4.49	4.05	3.65	3.29
119116CD	3V60R	3-lead (pin)	3.6V	60mA-h	3.75	3.39	3.05	2.75
101653CD	NA101-1	2-lead (eyelet)	3.6V	60mA-h	5.49	4.95	3.95	3.25

* Reference number may vary

TEMPEST Lead Acid Batteries

- .187" color-coded terminals (except P/N 159679CD - .470")
- Sealed • UL approved
- Rechargeable • Two-year warranty

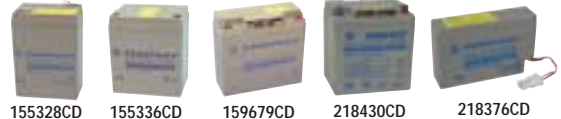

Tempest is an ISO-9001 Certified Company

Part Number	Product Number	Nom. Volt.	Amp-Hrs.	Charging Voltage		Cross Reference			Size L" x W" x H"	Wt. (lbs.)	Pricing	
				Standby	Cyclic	Panasonic	YUASA	Eagle Picher			1	10
218309CD	TR1.3-6	6	1.3	6.8-6.9	7.25-7.45	LC-R01R3P	NP01.2-6	CF6V1.6	3.8 x 1.0 x 2.0	0.7	\$7.89	\$7.39
155328CD	TR4-6	6	4	6.75-6.9	7.2-7.5	LCR6VP	NP4-6	CF16V4	2.8 x 1.9 x 4.0	1.8	10.49	9.25
218317CD	TR5-6A	6	5	6.8-6.9	7.25-7.45	LCR6V4PL	NP4-6	CF6V4.5	2.8 x 1.9 x 4.0	2.1	11.45	10.49
218325CD	TR5-6B	6	5	6.8-6.9	7.25-7.45	—	—	—	2.6 x 2.6 x 3.8	2.2	11.45	10.49
218333CD	TR7-6	6	7	6.8-6.9	7.25-7.45	LC-R067R2P	NP7-6	CF6V7	6.0 x 1.3 x 3.8	3.0	12.95	10.29
218341CD	TR8-6A	6	8	6.8-6.9	7.25-7.45	—	—	CF6V8	3.9 x 2.2 x 4.5	3.8	14.95	13.59
175054CD	TR10-6	6	10	6.75-6.9	7.2-7.5	LCR6V10P	NP10-6	CFM6V10	5.9 x 2.0 x 3.8	4.3	15.49	13.95
218350CD	TR12-6A	6	12	6.8-6.9	7.25-7.45	LC-R0612P	NP10-6	CF6V12	5.9 x 2.0 x 3.8	4.6	15.95	12.49
218368CD	TR14-6TH	6	14	6.8-6.9	7.25-7.45	—	—	—	4.3 x 2.8 x 5.5	6.0	25.95	23.49
218376CD	TR0.8-12	12	0.8	13.6-13.8	14.5-14.9	—	NP0.8-12	—	3.8 x 1.0 x 2.4	0.8	15.95	14.49
218384CD	TR1.3-12	12	1.3	13.6-13.8	14.5-14.9	LC-R121R3PU	NP1.2-12	CF12V1.3	3.8 x 1.7 x 2.0	1.3	16.49	14.85
159661CD	TR2.3-12	12	2.3	13.5-13.8	14.4-15	LCR12V2.2P	NP2.3-12	CF12V1.5	7.0 x 1.3 x 2.3	1.9	16.95	15.25
218392CD	TR2.9-12	12	2.9	13.6-13.8	14.5-14.9	—	—	—	3.1 x 2.2 x 3.9	2.5	17.95	16.49
218405CD	TR3.2-12	12	3.2	13.6-13.8	14.5-14.9	LC-R123R4P	NP3.2-12	CF12V3	5.3 x 2.7 x 2.4	3.1	19.95	17.95
155336CD	TR4-12	12	4	13.5-13.8	14.4-15	LCR12V4PF	NP412	CF12V4	3.6 x 2.8 x 4.0	3.4	17.95	16.19
218413CD	TR5-12	12	5	13.6-13.8	14.5-14.9	LC-R125P	NP5-12	—	6.6 x 6.9 x 4.9	21.1	18.49	16.65
155344CD	TR7.5-12	12	7.5	13.5-13.8	14.4-15	LCR12V7.2BP	NP712	CFM12V65	6.0 x 2.6 x 4.0	5.9	18.95	17.15
168188CD	TR12-12	12	12	13.5-13.8	14.4-15	PS12120	—	CFM12V12	5.9 x 3.8 x 3.8	9.0	30.95	26.95
159679CD	TR18-12*	12	18	13.5-13.8	14.4-15	LCR12V17BP	NPG18-12	CF12V18	7.1 x 3.0 x 6.6	13.8	34.95	29.95
218421CD	TR22-12	12	22	13.6-13.8	14.5-14.9	—	—	—	7.2 x 3.0 x 6.6	15.0	39.95	35.95
218430CD	TR26-12	12	26	13.6-13.8	14.5-14.9	—	NP24-12	CFM12V2	6.6 x 6.9 x 4.9	21.1	54.95	48.49
218448CD	TRU1-34	12	34	13.6-13.8	14.5-14.9	—	—	—	7.8 x 5.2 x 6.2	25.6	57.95	52.95
218456CD	TR55-14	12	55	13.6-13.8	14.5-14.9	—	—	—	9.0 x 5.4 x 8.2	39.7	94.95	88.49
218464CD	TR70-12B	12	70	13.6-13.8	14.5-14.9	—	—	—	10.3 x 6.7 x 8.2	55.1	148.95	134.95

*159679CD: Bolt terminals w/ bolt & nut set

Battery Holders

Eliminate battery retention problems in portable DC power applications and products. High-retention snaps are made from special materials that maintain retention properties longer than conventional snaps. They can be with leads, or attached to battery holders.

Part No.	Product No.	Fig.	No. Of Cells	Connector	Sides	Features	1	10	100	500
216071CD	BH-311-2A	1	1-AA	Wires	Single		\$.69	\$.59	\$.54	\$.49
216080CD	BH-321-2A	3	2-AA	Wires	Single		.69	.59	.54	.49
216098CD	BH-321-4A	3	2-AA	Wires	Single	With mounting tabs	.69	.59	.54	.49
216101CD	SBH-321-2A	5	2-AA	Wires	Single	With cover, no switch	.79	.69	.64	.59
216119CD	SBH-321-1AS	5	2-AA	Wires	Single	With cover and switch	.79	.69	.64	.59
216127CD	BH-322-1B	4	2-AA	Snaps	Dual		.69	.59	.54	.49
216135CD	BH-331-A	6	3-AA	Snaps	Single		.89	.79	.74	.69
216143CD	SBH-331-AS	7	3-AA	Wires	Single	With cover and switch	.99	.79	.75	.68
216151CD	BH-341-2A	8	4-AA	Wires	Single		.99	.89	.84	.79
105857CD	*	12	4-AA	Wires	Single	Wires with connector	.89	.75	.68	.59
216160CD	BH-342-A	9	4-AA	Wires	Dual		.69	.53	.47	.43
216178CD	BH-343-1A	10	4-AA	Wires	Dual		.75	.55	.49	.45
216186CD	SBH-341-1AS	13	4-AA	Wires	Single	With cover and switch	1.09	.89	.85	.75
216194CD	BH-341-2B	8	4-AA	Snaps	Single		.76	.59	.53	.47
216207CD	BH-343-1B	10	4-AA	Snaps	Dual		.99	.89	.84	.79
216215CD	BH-363-A	15	6-AA	Wires	Dual		.95	.79	.69	.65
216223CD	BH-364-A	14	6-AA	Wires	Single		.95	.79	.72	.65
216231CD	BH-363-B	15	6-AA	Snaps	Dual		.99	.75	.69	.65
216240CD	BH-383-A	17	8-AA	Wires	Dual		1.19	.99	.89	.85
216258CD	BH-382-B	16	8-AA	Snaps	Dual		1.19	.99	.89	.85
216266CD	BH-383-B	17	8-AA	Snaps	Dual		1.19	.99	.89	.85
216274CD	BH-411-1A	1	1-AAA	Wires	Single		.69	.59	.54	.49
216282CD	BH-421-1A	3	2-AAA	Wires	Single		.69	.59	.54	.49
216291CD	SBH-421-AS	5	2-AAA	Wires	Single	With cover and switch	.79	.69	.59	.49
216303CD	BH-431-1A	6	3-AAA	Wires	Single		.89	.79	.74	.69
216311CD	SBH-431-1AS	7	3-AAA	Wires	Single	With cover and switch	.79	.69	.59	.49
216320CD	BH-441-1A	8	4-AAA	Wires	Single		.99	.89	.84	.79
216338CD	SBH-441-AS	13	4-AAA	Wires	Single	With cover and switch	1.39	1.15	1.05	.95
216346CD	BH-211-A	1	1-C	Wires	Single		.62	.56	.51	.44
216354CD	BH-221-A	3	2-C	Wires	Single		1.09	.99	.94	.84
216362CD	BH-242-1A	11	4-C	Wires	Single		1.39	1.29	1.09	.99
216371CD	BH-111-1A	1	1-D	Wires	Single		.69	.59	.54	.49
216389CD	BH-121-1A	3	2-D	Wires	Single		.89	.75	.69	.59
216397CD	BH-121-1B	3	2-D	Snaps	Single		.99	.85	.75	.69
216400CD	BH-142-A	11	4-D	Wires	Single		1.19	.95	.85	.75
216418CD	BH-143-1A	8	4-D	Wires	Single		1.15	.89	.81	.74
216426CD	BH-9V-A	2	1-9V	Wires	Single		.79	.69	.64	.59
216434CD	BH-511-1A	1	1-N	Wires	Single		.69	.59	.54	.49
38535CD	2S2032	18	1-CR2032	PC Mount	Coin Cell		.59	.49	.35	.25
38543CD	2S2325	18	1-CR2354 or 2-CR2325	PC Mount	Coin Cell		.99	.89	.69	.49

* Battery holder used in many personal computers

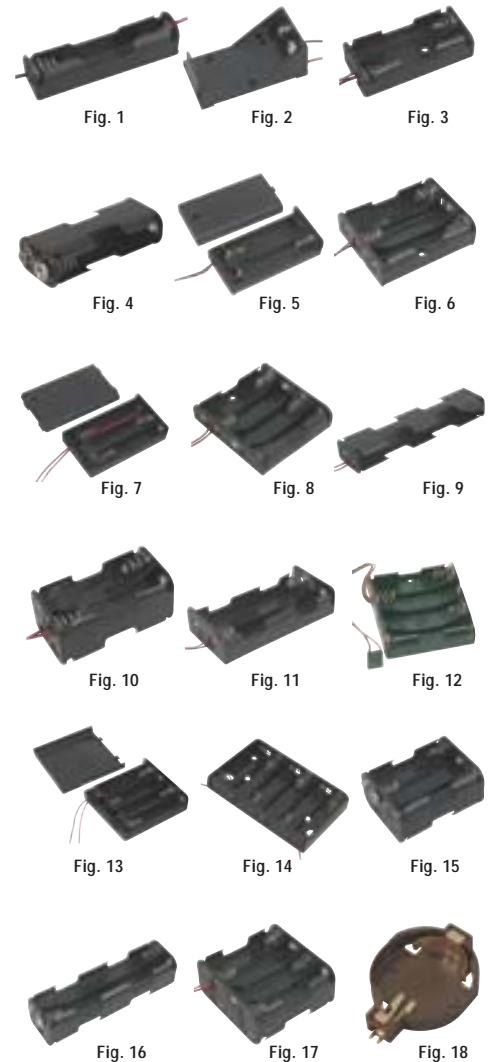

"9-Volt" Battery Snaps and Clip

- Use with standard "9 volt" batteries
- Fully insulated; contacts are nickel-plated brass
- Leads are color-coded, stripped and pre-tinned
- Snap: male outer diameter = 0.225"
- Female inner diameter: 0.215"

* 10 piece minimum

Part Number	Fig.	Description	Dimensions (in.)			Pricing			
			L	W	H	1	10	100	1000
11279CD	1	3", 26 AWG, 6 prong battery snap	1.0	.50	—	\$.25	\$.22	\$.19	\$.16
105793CD	2	Battery holder clip	.63	.71	1.2	.28	.23	.16	.14
109153CD	3	6", 26 AWG, 6 prong battery snap	1.0	.50	—	*	.17	.15	.135
101469CD	3	10", 26 AWG, 6 prong battery snap	1.0	.50	—	.29	.25	.21	.14
216451CD	4	6", 26 AWG, 6 prong battery snap	1.0	.50	—	.34	.30	.20	.18

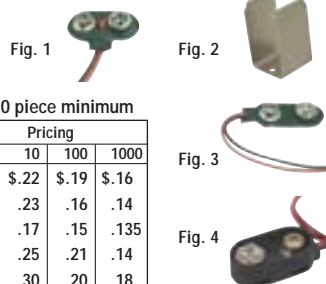

NiMH Battery Charger

Charge your AA or AAA NiMH batteries with this 8-hour battery charger. Simply plug into a wall outlet. Red LED indicates charging and green LED indicates ready to use.

- Charging bay allows 4AA or 4AAA batteries to be charged at the same time
- Output: 4AA 1.35V @ 250mA or 4AAA 1.35V @ 95mA
- Size: 2.8"W x 2.4"D x 4.6"H • Weight: 1.0 lb.

Part No.	Description	1	10
217533CD	Plug-in charger	\$7.95	\$6.95

We'll Send It Today!

Don't worry about backorders. Over 99% of our products are in stock! Just place your order by 6PM EST for same business day shipment.

High-Efficiency Robotic Servo

Excellent power-to-weight ratio for robotic projects.

- Supply voltage: 4.8-6 volts
- Torque: 49 oz.-in. @ 4.8V
- Speed: 16 seconds to 60°
- Can be operated by P/Ns 153648CD, 151001CD, pg 64 and 157059CD, see right
- Size: 0.8"W x 1.4"D x 1.6"H



Part No.	Description	1	10
157067CD	Robotic servo	\$19.95	\$17.95

Giant Robotic Ball-Bearing Servo

Extremely powerful! Perfect for large robotic projects where power is a must.

- Power supply volt.: 4.8-6 volts
- Torque: 161 oz.-in.
- Speed: 19 seconds to 60°
- Can be operated by P/Ns 153648CD & 151001CD, pg 64 and 157059CD, see above right



Part No.	Description	1	10
166351CD	Giant robotic servo	\$49.95	\$44.95

Spider Couplers

- Used with motors
- 1 set screw/hub
- Hub OD: 0.625" Dia.
- Hub length: 0.56"
- Parts sold individually

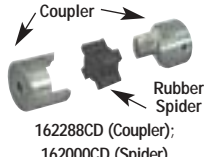

Part No.	Description	1	10	50
162288CD	.125" (3.18 mm) hub	\$1.35	\$1.25	\$1.09
161998CD	.197" (5.00 mm) hub	1.09	.89	.59
162270CD	.250" (6.35 mm) hub	1.35	1.19	1.09
162000CD	Rubber spider	1.29	1.15	1.05

Climax Spider Shaft Couplers



- 1 set screw per hub
- Hub OD: 0.625" Dia.
- Hub length: 0.56"

Part No.	Description	1	10	100
209285CD	.156" shaft hub	\$.69	\$.52	\$.35
106606CD	.250" shaft hub	.75	.65	.49
106622CD	Rubber spider	.75	.68	.61
138288CD	.250" sleeve coupler	4.49	4.05	3.65

Spider Coupler Set

- Used with motors
- 1 set screw per hub
- Hub OD: 0.785"D
- Hub length: 0.743"L
- For 0.25" shaft diameter



Part No.	Description	1	10	100
211166CD	Spider coupler set	\$2.95	\$2.39	\$2.19

Radio Control System

- 75MHz band
- 1/4 mile range
- 2-channel proportional operation
- HP-2RNB mini AM receiver
- 2 HS-303 standard servos
- Size: 7.5"L x 2.25"W x 2.25"H
- Weight: 1.5 lbs.



Requires: 8 AA batteries

Part No.	Description	1	10
157059CD	Radio control system	\$89.95	\$79.95

Robot Drive Wheels

- Extremely high traction foam rubber compound
- 2 hubs with mounting hardware
- Size: 2.5"Dia. x 2.0"W



Part No.	Description	1	10
157227CD	Drive wheels (2 pc set)	\$27.95	\$24.95

Easy Roller Robot Wheel Kit

Designed to simplify mechanical mounting requirements for small robotic projects. This product replaces mechanical mounting systems with a dependable solid structure and provides an easy-to-implement method of engineering a skid-steering drive system.

- No load current: 111mA
- No load speed: 200 RPM
- Wheel size: 2.0"W x 2.5"Dia.



Part No.	Description	Operating Voltage Range	Torque	Gear Ratio	1	10
215571CD	Roller robot wheel kit	4.5-12VDC	3.6kg.cm	30:1	\$52.95	\$48.98

8-Pitch Gears and Gear Set

- Works with DC motors with 0.08" shaft diameter
- Heavy-duty plastic construction
- Pitch: 0.125"
- Bore size: 0.154" • Material: polyethylene resin

162392CD: 0.15" bore to 0.070" bore
 131801CD: 20-piece gear set includes 2 each of the following: T10, T20, T30, T40, T50 and 10 bushings

* Prepackaged: please order in increments of 10



Part No.	Description	Bore	Shaft O.D.	Shaft Dia.	Press Fit Gear Dia.	1	10	100
162069CD	10 teeth gear	0.151"	0.48"	0.156 (5/32)"	0.457"	\$.69	\$.62	\$.59
162077CD	20 teeth gear	0.151"	0.875"	0.156 (5/32)"	0.855"	.59	.50	.39
162085CD	30 teeth gear	0.151"	1.27"	0.156 (5/32)"	1.239"	.69	.62	.56
162093CD	40 teeth gear	0.151"	1.67"	0.156 (5/32)"	1.634"	.33	.30	.27
162106CD	50 teeth gear	0.151"	2.07"	0.156 (5/32)"	2.016"	.35	.30	.25
162392CD	Bushing	0.075"	—	0.078 (5/64)"	0.160"	*	.24	.22
Part No.	Description				1	10	50	
131801CD	Gear set - 20 piece (see description above)				\$7.99	\$7.29	\$6.49	

16-Pitch Sprocket Set and Chain

- Operates in high humidity and corrosive environments
- Chain links can easily be added or removed to adjust total length
- Chain tension load: 2.0 lbs.

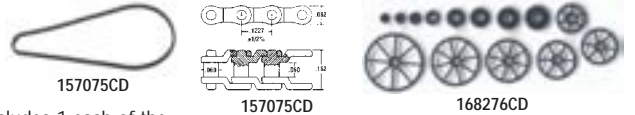

168276CD: 14-piece sprocket set includes 1 each of the following: 8, 9, 10 teeth at 1/8" bore size; 12, 15, 16, 18, 20, 24, 30, 32, 36, 40 and 48 teeth at 1/4" bore size

Part No.	Description	1	10	25
157075CD	Drive chain (12" long)	\$9.95	\$8.95	\$7.95
168276CD	Sprocket set - 14 pieces (see description above)	29.49	26.49	23.89

Hub and 48-Pitch Gear Set

- Low coefficient of friction requires little or no lubrication
- Residual stress removed by annealing process

168284CD: 12-piece gear set includes 1 each of the following: 10 teeth at 1/2" bore size; 14 and 16 teeth at 3/8" bore size; 20, 24, 30, 36, 44, 54, 66, 84 and 100 teeth at 1/4" bore size



Part No.	Description	1	10	25
157104CD	1/4" bore aluminum mounting hub w/ set screws	\$4.95	\$4.49	\$3.95
168284CD	Gear set - 12 pieces (see description above)	39.95	34.95	31.95

OWI® Selectable Gear Box Kit

Great 35-piece kit for learning about gear ratios or to add a gear box to your robot project. See-through case has gear ratios from 6.8:1 to 807.93:1.

- Difficulty level: intermediate

Part No.	Description	Dimensions	1	10
145509CD	Selectable gear box kit with 3V motor	2.5"L x 1.1"W x 1.5"H	\$12.99	\$11.69



Jameco's Low-Price Guarantee

We'll match the advertised price of any like product.

SALE

OWI® Robotic Arm Trainer Kit ▲ 109-piece kit

Five Axis of Motion

Teaches basic robotic sensing and locomotion principles while testing your motor skills as you build and control the arm. This unit can be commanded or instructed through its five-switch wired controller with lights to grab, release, lift, lower, rotate wrist, and pivot sideways. Five motors and joints allow flexibility.

- Max. length outwards: 14.2"
- Max. height upwards: 20.1"
- Max. lifting capacity: 4.6 oz.
- Elbow moving range @ 135°
- Wrist rotation clockwise or counter clockwise @ 340°
- Rotates left to right at the base @ 350°
- Grip opens to 2" wide
- Shoulder movement @ 120°
- Weight: 4.5 lbs.



Requires: 4 D batteries (not included)



Part No.	Description	1	10
157366CD	Robotic arm kit (unassembled)	\$74.95	\$67.49
159345CD	Robotic controller software (assembled)	84.95	76.49

Speech Recognition Kit ▲ 42-piece kit

Program the words you want the circuit to recognize, connect the interface kit to the main board and interface with the robotic arm kit. Now you can command movements to the robotic arm through speech. The heart of the speech recognition kit is the HM2007 IC wherein you can program 40 words @ 0.96 seconds word length or 20 words @ 1.92 seconds word length.



- Can be used independently

Part No.	Description	1	10
208611CD	Speech Recognition Kit	\$119.95	\$107.95

Robotic Arm PC Interface Kit ▲ 31-piece kit

With a PC and the software provided, you can program this interface kit for the robotic arm to do a sequence of movements at precise steps or repeat the sequence.

Includes: DB25 male to female cable & software diskette



Part No.	Description	1	10
208637CD	PC Interface Kit	\$69.95	\$62.95

OWI® Amphibious Solar Vehicle ● 28-piece kit

This kit introduces the fundamentals of solar power through hands-on experiments. The sun or any intense mobile light can power the solar battery (included). A multiple function switch (solar 1.4V, 350mA) allows this kit to be energized day or night, indoors or outdoors. Its structured "catamaran" design reduces water resistance, thus reducing the possibility of capsizing. It's street tough, water ready, and solar powered.

- Power source: solar battery (1.4V @ 350mA)
- DC motor: 1.9V @ 1.45mA rated



Part No.	Product No.	Dimensions	Wt. (lbs.)	1	10
215853CD	OWI-688	9.5"L x 6.5"W x 3.1"H	1.0	\$39.95	\$35.95

Robot Builder's Source Book

McGraw-Hill Everything you need to find – and acquire – common and uncommon robotic parts and supplies. Jameco Electronics and over 2500 mail order suppliers and other sources, including local and international businesses, cross-referenced and categorized to make your search quick and easy. (711 pages, 2003) • Size: 8.5" x 10.0" • Weight: 3.9 lbs.



Part No.	Description	1	10
213461CD	Robot Builder's Source Book	\$19.95	\$17.95

See page 215 for Programming Robot Controllers Book

OWI® Soccer Jr. Kit ● 242-piece kit

Wire Controlled

New and improved Soccer Jr. kit with the addition of a third motor used to catch and shoot the ball (included). This kit has 6 operational legs, a retrieving and kicking mechanism, and a wired controller to activate movement and ball control. Runs forward, backward, turns left and right, and executes a 360° turn.



- Assembled electronic PC board
- 6 legs driven by 2 DC motors
- Power usage: approximately 900mA max.

Requires: 4 AA batteries (recommend P/N 198715CD, pg 202)

Part No.	Product No.	Dimensions	Wt. (lbs.)	1	10
215861CD	OWI-9820	6.7"L x 3.4"W x 5.5"H	2.0	\$44.95	\$40.55

OWI® Soccer PRO Kit ● 167-piece kit

Wire Controlled

Soccer PRO kit is the mechanical soccer player's dream kit, for those who thrive speed, excitement, and coordination. Its fast track two wheel motor systems power the unit to create sonic movements and maneuvers, and the third motor catches, carries, and shoots the ball (included).



- Assembled electronic PC board
- Power consumption: 900mA max.

Requires: 4 AA batteries (recommend P/N 198715CD, pg 202)

Part No.	Product No.	Dimensions	Wt. (lbs.)	1	10
215870CD	OWI-9850	4.7"L x 5.1"W x 3.0"H	2.0	\$44.95	\$40.55

OWI® Obstacle Avoidance Robot Kit ▲ 107-piece kit

Six crank motion legged robot utilizes an infrared light sensing system to find obstacles and maneuvers itself around them. This IR detection kit includes an infrared diode, photo diode, IC, 2 DC motors and all hardware.



Part No.	Description	Dimensions	Wt. (lbs.)	1	10
140821CD	Spider kit	12.0"L x 7.0"W x 3.5"H	1.2	\$59.95	\$53.95

OWI® Line Tracking Robot Kit ▲ 134-piece kit

Watch as this robot follows a black line you specify. Utilizes infrared light to detect the line and control direction. This educational kit utilizes the same line follow principle of many industrial robots.



Part No.	Description	Dimensions	Wt. (lbs.)	1	10
140839CD	Line tracker kit	12.0"L x 7.0"W x 3.5"H	1.1	\$49.95	\$44.49

OWI® Rockit Robot Kit ▲

Explore the fundamentals of robotics with this informative and entertaining robot kit. An intelligent robot with a touch/sound sensor, if it comes in contact with an object or hears a loud noise, it automatically reverses, then turns left.



- Soldering required of PCB
- Size: 4.5"L x 5.0"W x 3.5"H

Requires: 2 AA batteries (recommend P/N 151087CD, pg 202)

Part No.	Description	Pieces	1	10
199603CD	Rockit robot Expert	96	\$21.95	\$19.55

velleman

Micro Bug Kits ■

A bright colored miniature bug shaped robot that is attracted to light.

- Two open chassis sub-miniature motors
- Adjustable light sensitivity that suits almost any light conditions
- LED "eyes" indicate driving direction
- Stops in total darkness
- Size: 4.0" x 2.4"



Requires: 2 AAA batteries (recommend P/N 185279CD, pg 202)

Part No.	Product No.	Description	Pieces	1	10
200328CD	MK127	Running	26	\$18.95	\$16.95
200336CD	MK129	Crawling	29	21.45	19.35

velleman Parking Radar Kit ■ 55-piece kit

Parking in tight places can be difficult, but this unit can tell you when you have come within an adjustable preset distance of the object behind you.

- Detection range: 5cm – 1.5m; angle: 5°
- Transmitter frequency: 40kHz
- PCB size: base (4.9"L x 1.9"W) sensor (3.8"L x 1.1"W)

Requires: 10-15VDC @ 16mA max (recommend P/N 100095CD, pg 55) or auto power plug (recommend P/N 115001CD, pg 59)

Part No.	Product No.	1	10	25
129120CD	K3502	\$39.95	\$35.99	\$32.39



SALE

Ultrasonic Motion Detector Kit ■ 49-piece kit

Detect motion/movement 13 - 23 ft. away and trigger an alarm w/ this kit.

- 2 boards: one with matched pair of ultrasonic transducers to detect motion from 13 to 23 ft. away; 2nd board contains crystal controlled oscillator & all circuits
- Switchable latch, red LED indicator
- Solder pad output to drive external relay or circuits
- Size: main board: 2.8"L x 2.0"W x 0.8"H; transducer board: 2.8"L x 0.6"W x 0.9"H

Requires: 9V battery (recommend P/N 151095CD, pg 202)

Part No.	Description	1	10
125090CD	Ultrasonic alarm kit	\$29.95	\$26.95



MONDO•TRONICS Flexinol Muscle Wires®

These unique nickel-titanium alloy Muscle Wires® actually shorten in length when electrically powered, and can lift thousands of times their own weight. • Length: 1 meter

How it works... Pressing the switch lets power flow from the batteries through the Muscle Wire®, heating it and causing it to contract and raise the lever and lift the weight. When power is removed, the Muscle Wire® cools and relaxes, and the weight helps it return to its starting position.

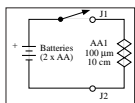
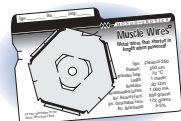

141348CD: Muscle Wires® Book & Deluxe Kit

- Kit includes one each Flexinol 100, 150 and 250 Muscle Wires® (below) and Project Book
- 3 meters of wire

Includes: Crimps and instructions

Part No.	Description	Wire Dia. (microns)	Linear Resistance (ohm/m)	Typical Current (mA)	Deform Weight* (grams)	Recovery Weight* (grams)	Typical Rate**	Pricing	
								1	10
141321CD	100LT	100	150	180	28	150	33	\$15.95	\$14.49
141874CD	150LT	150	50	400	62	330	20	16.95	15.29
160055CD	375LT	375	8	2750	393	2000	4	19.95	17.95

* Multiply by 0.0098 to get force in Newtons ** Cycles per minute, in still air, at 20° Centigrade

Part No.	Description	1	10
141348CD	Muscle Wires® kit	\$59.95	\$53.95

MONDO•TRONICS Electric Pistons™

Deluxe 5 Pack

The Electric Piston is a shape memory alloy actuator that pulls with up to one pound of force and contracts by 20mm. Typical activation requires one volt at five amps for two seconds. Plus, mount several pistons in parallel for more strength, and in series for longer strokes.

Includes: Five pistons, battery, leads and plans for four complete projects

Part No.	Description	1	10
141903CD	Electric piston pack (1 volt @ 5 amps)	\$39.95	\$34.95

Flex Sensor

- Maximum resistance: 30kΩ to 40kΩ, proportional to the degree of flexing or bending
- Applications: virtual reality data gloves, robotic, bio-metric, physics and engineering
- Nominal resistance: 10kΩ

Part No.	Description	1	10	100
150551CD	Flex sensor	\$12.95	\$11.65	\$10.49



velleman Scrolling Message Kit ■ 76-piece kit

Create your own scrolling message with this 35-LED graphic display kit. Press "SET" to change a particular character, "UP or DOWN arrow" to select the character, and end your scrolling message with the "<" character.

- 35-LED display
- Maximum 16 characters
- Adjustable scrolling speed

Requires: 9 to 12VDC @ 20mA (recommend P/N 100845CD, pg 55)

Part No.	Product No.	Dimensions	Wt. (lbs.)	1	10
200310CD	MK124	3.5"L x 2.6"W x 1.8"H	0.2	\$24.95	\$22.45



velleman 3-Channel Light Organ Kit ■ 80-piece kit

Add a 3-channel dancing light display to your music. Each channel displays a different range of sound.

- Frequency ranges are adjustable
- Line or microphone input
- Maximum load 2A per channel
- Each output has individual sensitivity control

Part No.	Product No.	Dimensions	Wt. (lbs.)	1	10
131684CD	K8017	6.7"W x 5.6"D x 1.7"H	1.2	\$59.95	\$53.95



velleman Stroboscope Kit ▲ 19-piece kit

Make your own snapshots and "lightning" light effects. Flash frequency adjustable from 2 - 20Hz.

- Input: 110VAC

Part No.	Product No.	Dimensions	Wt. (lbs.)	1	10
117639CD	K5300	3.5"L x 2.6"W	0.5	\$18.95	\$16.95



velleman Flashing LED Sweetheart Kit ■ 46-piece kit

This kit shows a beating heart. Great for decorations!

- Power consumption: 8mA

Requires: 8 to 15VDC wall transformer (P/N 100095CD, pg 55) or 9VDC battery (P/N 151095CD, pg 202)

Part No.	Product No.	Dimensions	Wt. (lbs.)	1	10	25
147555CD	MK101	2.5"L x 2.4"W x 1.2"H	0.1	\$11.95	\$10.95	\$9.95



velleman Flashing LED Kit ■ 23-piece kit

Activates 2 flashing LEDs for applications such as model constructions. Adjustable flashing speed by potentiometers.

- 5.5" wire w/ 9V battery connector
- Minimum consumption: 4mA

Requires: 9VDC battery (P/N 151095CD, pg 202)

Part No.	Product No.	Dimensions	Wt. (lbs.)	1	10	50
147580CD	MK102	1.3"L x 1.4"W x 0.6"H	0.1	\$7.95	\$7.19	\$6.45

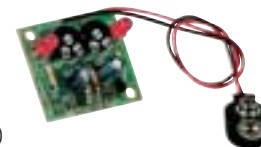

Light Sensitive Relay Kit ■ 20-piece kit

Build a stable and advanced circuit that uses light to control a SPDT 10A relay.

- Dimensions: 2.4"L x 1.3"W x 1.0"H

Requires: 12VDC power supply (recommend P/N 100095CD, pg 55)

Part No.	Description	Wt. (lbs.)	1	10	25
136223CD	Light relay kit	0.1	\$12.49	\$11.19	\$9.99



Jameco Special Values!

See the yellow and green highlighted items. Sale details are on page 4.

CEBEK 1 Second to 3 Minute Timer Module

By operating a button, the relay will be activated for the selected time.

- Output contact rating: 5A @ 200VAC
- Size: 3.0"L x 1.7"W x 1.2"H

Requires: Power supply 12V @ 50mA (recommend P/N 100095CD, pg 55)



Part No.	Description	1	10	25
147871CD	I-1 timer	\$19.95	\$17.95	\$15.95

3 Second On to 1 Minute Off Cyclic Timer Module

By triggering the timer, the contacts will be engaged. Once this time has expired, the relay will remain in the off state for 3-60 seconds. It then restarts, repeating the on and off process until power is disconnected.

- Output by relay
- Contact rating: 5A @ 200VAC
- Size: 3.0"L x 1.7"W x 1.2"H

Requires: Power supply 12V @ 50mA (recommend P/N 100095CD, pg 55)



SALE

CEBEK

Part No.	Description	1	10	25
147846CD	I-10 timer	\$22.49	\$20.29	\$19.39



Pocket Watch B Module

Contains a real time clock, calendar and advanced timing features. Keeps track of seconds, minutes, hours, days, months, and years.

- For use with P/N 130892CD - BS2-IC, pg 200
- Standard TTL • Easy-to-use 1 or 2 wire interface
- Easy-to-use SIP package
- Four types of user configurable alarms
- Leap year compensation
- Externally accessible, precision timebase • One-year warranty

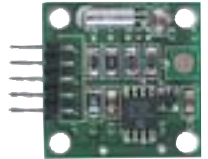

Part No.	Description	1	10
145630CD	Pocket watch B module	\$29.95	\$28.95

velleman Scrolling Clock Kit ■ 36-piece kit

Animated rolling time and date display. Select hours, minutes, month or day with the "SELECT" button and enter values with "SET" button.

- 35-LED display • Size: 2.6"L x 3.5"W x 1.8"
- Time display in 12-hour or 24-hour mode
- Power required: 9VDC to 12VDC @ 20mA



SALE

Part No.	Product No.	1	10
200301CD	MK123	\$19.95	\$17.95

Power Supply and Motor Kits

velleman 1 Amp Power Supply Kit ■ 12-piece kit

Provides a regulated voltage adjustable between 1.2 and 35 volts at 1 amp. LM317 regulator gives you remarkably better ripple and regulation characteristics than conventional regulators. Chip includes current limiter and thermaloverload protection.

- Output current max.: 1.5A • Max. dissipation: 15W (cooled)
- Max. input voltage: 40V

Requires: 25.2VCT @ 2A quick connect power transformer (recommend P/N 102103CD or equivalent, pg 47)



Part No.	Product No.	Dimensions	1	10	25
117621CD	K1823	2.1"L x 2.1"W	\$12.95	\$11.65	\$10.49

Dual Adj. Regulated Power Supply Kit ■ 48-piece kit

Build a dual adjustable power supply for your circuits. Outputs positive-negative voltages from ±5 to ±15VDC.

- Adjustable positive and negative supplies ±5 to ±15VDC, 175mA - 750mA per supply • 120VAC input
- LED on indicator • PC board construction

Includes: Components and hardware

Part No.	Mfr. Cross Ref. No.	Dimensions	Wt. (lbs.)	1	10	25
20626CD	JE215	5.1"L x 3.5"W x 2.0"H	2.1 ..	\$22.95	\$20.49	\$18.49



velleman DC to Pulse Width Modulator Kit ▲ 40-piece kit

The circuit converts a DC voltage into a series of pulses, such that the pulse duration is directly proportional to the value of the DC voltage.

- PWM range: 0 to 100%
- PWM frequency: 100Hz to 5kHz (adjustable)
- Operating voltage: 8 to 35VDC
- Min. consumption: 35mA • Max. output current: 6.5A
- Efficiency: better than 90% at full load
- Adjustable sensitivity: 2.5 to 35VDC

Part No.	Product No.	Dimensions	Wt. (lbs.)	1	10	25
120539CD	K8004	3.3"L x 1.9"W x 1.8"H	0.5	\$22.95	\$20.49	\$18.95



DC Motor Speed Control Kit ■ 35-piece kit

- This kit uses Pulse Width Modulation to vary the speed of a DC motor and maintain torque
- For motors up to 100VDC/5A max.

Requires: 5-16VDC supply (recommend P/N 114825CD, pg 56)

Part No.	Description	Dimensions	1	10
127829CD	Motor control kit	3.6"L x 2.3"W x 1.2"H	\$19.95	\$17.95

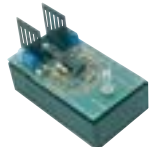

Unipolar Stepper Motor Driver Kit ■ 29-piece kit

- Will drive unipolar stepper motors rated up to 6-30VDC @ 1.25A
- Drives 5, 6 or 8 lead unipolar stepper motors
- Onboard 5VDC regulator

Part No.	Description	Dimensions	1	10
139109CD	Stepper motor	2.6"L x 1.9"W x 1.0"H	\$29.95	\$26.95



DC Voltage Monitor Kit ● 46-piece kit

If battery status is important, you need this kit. It uses 7 LEDs to monitor 12VDC in 1V, 0.5V, or 0.25V steps. Monitor 8V or 5V in 0.25V steps. Great for boats, motor homes, model planes or race car Ni-Cads.

Part No.	Mfr. Cross Ref. No.	Dimensions	1	10
181833CD	VM-1	2.7"L x 1.3"W	\$8.95	\$7.95



Electronic Dice Kit

velleman Dual Electronic Dice Kit

Board games provide an excellent source of entertainment. However, the dice can be a constant source of distraction: they fall off the table, allow cheating, results may not be seen properly and so on. There can be no doubt at all about the result displayed on this electronic dice module, and cheating is out of the question. Displays are switched off automatically after 30 seconds to save battery power.

- Two fully independent dice, at your choice you can play with one or two dice.
- 85-piece kit
- Experience level: Intermediate

Part No.	Product No.	Dimensions	Wt. (lbs.)	1	108.95
200352CD	K3400	3.0"L x 2.8"W	0.5	\$18.95	\$16.95

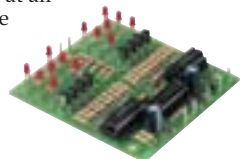

Educational



Phone 1-800-831-4242

Fax 1-800-237-6948

Order Anytime 24x7x365

Online www.Jameco.com

velleman

Infrared and RF Code Lock Transmitters and Receivers

- Use for car alarms, garage doors, door locks, lighting control, etc. • Over 8000 selectable codes
- Use several transmitters with one receiver
- Receivers feature relay output (10A change-over or pulse contact)



Requires: Transmitter: 12V battery type V23G; receivers: 12-16VDC @ 100mA (recommend P/N 100095CD, pg 55)

Specifications:

Transmitter	117647CD	117647CD	134543CD
Transmission	RF	RF	IR
Channels	2-ch	1-ch	1-ch
Range	100'	100'	23'
Experience	expert	expert	novice
Use w/ receiver	173235CD	117655CD	134551CD



Part No.	Description	Kit Pieces	Wt. (lbs.)	1	10
117647CD	K6706 2-ch transmitter (RF)	29	0.3	\$16.95	\$14.95
173235CD	K6727 2-ch receiver (RF)	75	0.5	\$39.95	\$35.95
117655CD	K6707A 1-ch receiver (RF)	75	0.5	\$29.95	\$26.99
134543CD	K6708 1-ch transmitter (IR)	16	0.3	\$13.95	\$12.49
134551CD	K6709 1-ch receiver (IR)	66	0.5	\$28.95	\$26.95

15-Channel Infrared Transmitter & Receiver

- Applications: remote on-off switch, alarms, garage door opener, etc.
- 15 independent channels
- Transmitter/receiver range: ±30 meters

120555CD: Transmitter

Requires: 9VDC battery (recommend P/N 151095CD, pg 202)

120547CD: Receiver

- Each output can be a change-over or pulse contact switch
- Output: 50VAC @ 500mA max.
- PCB dimensions: 2.8"L x 5.7"W
- For greater power output use P/N 128910CD, below

Requires: 8-14VDC (recommend P/N 100095CD, pg 55 or 129314CD, pg 56)

Part No.	Description	Kit Pieces	Wt. (lbs.)	1	10
120555CD	K6710 15-ch transmitter	37	0.8	\$64.95	\$58.39
120547CD	K6711 15-ch receiver	76	0.5	\$44.95	\$39.95

Computer Control Interface Kit

Connects to printer port without interruption of the printer. Works well in control applications such as the DC dimmer (P/N 128901CD, right) and infrared transit/receiver (P/Ns 120555CD and 120547CD, above).

- 16 I/Os with opto coupler
- Analog outputs: eight 6-bit (64 steps), one 8-bit (256 steps)
- Analog inputs: four 8-bit (256 steps)
- Full opto-isolation with computer
- 3.5" driver disk w/ routines in C++, QBASIC, Turbo Pascal

Requires: DB25 cable (P/N 65787CD, pg 184)

Part No.	Product No.	Dimensions	Wt. (lbs.)	1	10
128928CD	K8000	9.3"L x 5.3"W	1.7	\$139.95	\$125.95

Remote Control by Telephone

- Possible to turn on or off up to three devices (switching lights on-off; check alarm systems; water heater on-off; garage doors)
- Check conditions of a switch (open or closed)
- Protected by a user-defined code
- Pick up after 3 or 8 rings (selectable)

Requires: 12VAC @ 300mA (recommended P/N 101258CD, pg 58)

Includes: Relay for one output (10A/250VAC)

Part No.	Product No.	Dimensions	Wt. (lbs.)	1	10
120678CD	K6501	4.1"L x 5.1"W	0.7	\$69.49	\$62.59



Infrared Remote-Control Receiver Modules



New



- Commonly used in TVs, VCRs, audio equipment, car stereos and home computers that receive signals or data via infrared
- Single unit module which incorporates a PIN diode & a receiving preamplifier IC
- Excellent mechanical strength and electrical stability
- 940nm wavelength • Size: 0.6"L x 0.6"W x 0.5"H

Part No.	Description	Voltage Input	1	10	100	1000
220628CD	38.0kHz, side view	4.5VDC @ 1.4mA	\$2.99	\$2.69	\$2.39	\$1.99
165008CD	40.0kHz, top view	5VDC @ 5mA	2.99	2.69	2.39	1.99
176541CD	56.8kHz, side view	5VDC @ 2mA	1.95	1.79	1.45	1.05

Infrared Transmitter & Receiver Kit

Transmit a 40kHz modulated I-R signal to a distance of 6' to 8'. Can be used as a remote switch to turn objects OFF and ON by infrared. The IR receiver will only receive 40kHz modulated infrared light. You can configure the output for normally ON or normally OFF operation. This allows you to use it as a security sensor or as a remote control switch. You can use the receiver to test TV or VCR remote controls.

- Transmitter size: 1.0"L x 0.8"W • Receiver size: 1.4"L x 1.2"W

Requires: 6 to 15VDC battery (recommend P/N 151095CD, pg 202)

Part No.	Mfr. Cross Ref. No.	Description	1	10
177092CD	IR-2	Transmitter/receiver	\$24.95	\$22.49



IR LED Illuminator Kit

- Improve low-light camcorder and CCD camera images without visible light
- 36 high powered infrared LEDs
- At 24" the beam is approximately 3.5" across

Requires: 12-15VDC power supply (recommend P/N 114825CD, pg 56)

Part No.	Description	Dimensions	1	10	25
157964CD	IR illuminator kit	2" Dia.	\$16.95	\$15.29	\$13.75



DC Controlled Dimmer Kit

This circuit is ideal for replacing an existing dimmer switch; can be used in a control application via P/N 128928CD interface board, left.

- Supply voltage: 110VAC or 220-240VAC, 50 or 60Hz
- Can be used for 24VAC • DC control voltage: 0-10VDC
- Maximum control current: 2.25mA @ 12V

Part No.	Prod. No.	Dimensions	1	10	25
128901CD	K8003	3.0"L x 2.0"W x 1.8"H	\$22.95	\$20.49	\$18.59



Relay Controller Kit

Universal Relay Card Kit

An electronic controller that switches higher currents while providing insulation between the controller and the controlled devices.

- 8 channels expandable to 15 with 8 each P/N 144186CD, below
- Relay output: maximum 5A/220VAC
- TTL or 5V CMOS inputs
- Contact voltage: 12VDC/250mA

Requires: 220 or 125VAC power source

Part No.	Product No.	Dimensions	Wt. (lbs.)	1	10
128910CD	K6714	8.3"L x 5.9"W	1.8	\$67.95	\$61.95
144186CD	VR15M121C relay (JZC-22F)		0.028	3.79	3.39



Crossbow Accelerometers and Interface

141591CD 1-Axis and 141575CD 3-Axis Accelerometers

- Dynamic range and excellent frequency response
- Acceleration range: $\pm 4g$
- Shielded cable: 2'L pigtail
- Size: 1.9"L x 1.0"W x 0.8"H

Requires: 5VDC power supply (not included – recommend P/N 164101CD, pg 54)

141583CD: Digital Accelerometer Interface

- Measures acceleration, impact, tilt, vibration, etc.
- Simple digital interface for 1-axis and 3-axis
- Plugs into any RS-232 port @ 38.4k baud
- 200Hz max. sampling rate
- Size: 3.0"L x 2.5"W x 1.3"H

Requires: DB9 male to female cable (recommend P/N 25700CD, pg 184)

Includes: User friendly graphical software and 9VDC @ 500mA power supply

Part No.	Description	Axis	Current	1	10
141591CD	CXL04LP1	One	8mA	\$114.95	\$103.45
141575CD	CXL04LP3	Three	24mA	319.95	299.95
141583CD	Digital interface card.....			312.95	299.95

Accelerometer Evaluation Boards

Dual Axis

Evaluation board for the ADXL202, dual axis, 2g accelerometer.

177308CD: features RS-232 interface to connect to PC serial ports. Also includes software to display real time acceleration data.

Part No.	Product No.	Description	1	10
177287CD	ADXL202EB	Dual axis	\$59.95	\$53.95
177308CD	ADXL202EB-232	w/ RS-232	159.95	144.95

Senix Distance Sensor Modules

Sends out a sound wave 20 times per second and calculates the distance based on the time differential between send and receive signals. The distance is represented by an output voltage from 0 to 10VDC (P/N 134105CD) or RS-232 signal (P/N 151482CD).

- Sensing range: 4" to 60"
- Sensor diameter: 1.8"
- Board size: 2.8"L x 1.8"W x 0.9"H
- One-year warranty

Requires: 15 to 24VDC @ 40mA (not included), recommend P/N 114825CD, pg 56

- 134105CD: • Output voltage: 0-10VDC
- Each 1VDC increment = 5.6" (e.g.: 1VDC output = 9.6")
- 151482CD: • RS-232 output

Includes: Disk and computer cable

Part No.	Description	Wt. (lbs.)	1	10
134105CD	Sensor – voltage output	0.2	\$159.95	\$143.95
151482CD	Sensor – RS-232 output	1.0	179.95	161.95

Need to power any application; visit Jameco's battery section on pages 202-203,

and on your way, don't forget to take a look at Jameco's expanded section of wall transformers on pages 54-58.



velleman Electronic Thermostat Kit ■ 29-piece kit

General low-cost thermostat with NTC temperature sensor. Output relay with LED indicator

- Temperature range: 5°C to 30°C (41°F to 86°F)
- Relay power rating: 24VDC/VAC 3A
- Size: 2.1"L x 2.4"W x 1.1"H

Requires: 12VDC @ 100mA (recommend P/N 100095CD, pg 55)

Part No.	Description	1	10
211799CD	Electronic thermostat kit	\$9.95	\$8.95

velleman Metal Detector ■ 22-piece kit

- Proximity range adjustable to 8cm
- LED indicator; can use a buzzer as an option (P/N 105822CD, pg 136) • Dimensions: 2.1"L x 2.1"W

Requires: 9V battery (recommend P/N 151095CD, pg 202)

Part No.	Product No.	Description	1	10	25
129091CD	K7102	Metal Detector	\$12.99	\$11.69	\$10.59

Function Generator Kit ■ 21-piece kit

Sine, Triangle and Square Wave

Great for prototyping electronic circuits, whether analog or digital! Produces sinusoidal, triangular, and square waveforms at frequencies continuously variable from 1Hz to 100kHz.

- 21-piece kit (chip, components, PC board, hardware)

Requires: 12VDC supply or ± 6 VDC split supply (recommend P/N 20626CD, pg 207)

Part No.	Mfr. Cross Ref. No.	Dimensions	1	10	25
20685CD	JE2206	4.1"L x 1.5"W	\$24.95	\$22.95	\$19.95

velleman Signal Generator Kit ● 34-piece kit

- Signal output: sine, triangle, square, and integrator wave (jumper selectable)
- Signal frequency: about 1KHz (fixed)
- Output level: adjustable from 0 to 100mVrms
- Size: 2.3"L x 1.7"W x 1.3"H

Part No.	Product No.	Description	1	10
200281CD	MK105	Signal Generator	\$9.95	\$8.95

velleman Liquid Level Controller Kit ▲ 73-piece kit

Controls the level of any container of liquid. Can replace the liquid sensors with temperature or light sensors for corresponding use.

- Alarm signal provided for desired applications

Requires: 12-14VAC @ 300mA minimum power supply (P/N 10081CD, pg 58)

Part No.	Product No.	Dimensions	Wt. (lbs.)	1	10
129154CD	K2639	4.1"L x 2.4"W x 1.0"H	0.5	\$22.95	\$20.65

velleman Water Leak Alarm Kit ● 7-piece kit

Alarms you of water overflows and leaks!

- Water sensor can be placed at a distance by cutting the board and using wires for connection
- Incorporated loud alarm buzzer

Requires: 9VDC battery (P/N 151095CD, pg 202)

Part No.	Product No.	Dimensions	Wt. (lbs.)	1	10
157315CD	MK108	2.8"L x 1.8"W	0.1	\$10.95	\$9.95

Over 99% of our products are in stock!

We'll Send It Today!

Just place your order by 6PM EST for same business day shipment.

Super Snooper Big Ear Audio Amplifier Kit

17-piece kit

Listen through walls, hear conversations across the room or listen to sounds a block away. Add a parabolic reflector or mount the microphone in a tube, to isolate unwanted noise and make a directional microphone.

• Operating voltage: 9VDC (recommend P/N 151095CD, pg 202)

Includes: Instructions, outputs for speakers or headsets and schematic

Part No.	Description	Dimensions	1	10	100
151204CD	Audio Amplifier Kit	1.8"L x 1.0"W x 0.6"H	\$10.95	\$9.95	\$8.95



FM Stereo Transmitter Mini Kit

37-piece kit

Run your own FM radio station! Plug any stereo signal into this unit and it will be transmitted to any FM radio. Tuneable from 76-108MHz. Plug in a CD player or tape deck and you have a wireless link to an FM radio within 200 feet. Clarity is approximately 40dB stereo separation.

Requires: 9VDC power supply (recommend P/N 151095CD, pg 202)

Part No.	Description	Dimensions	1	10
151239CD	FMST-100 stereo kit	2.7"L x 2.0"W	\$29.95	\$26.95



FM Transmitter

26-piece kit

Mini FM transmitter (100-108MHz) ideal for family broadcasts, baby monitors and security. May be received by any portable FM radio or tuner.

• Integrated pre-amplifier (sensitivity 5mV)

Requires: 9-12VDC power supply (recommend P/N 20626CD, pg 207)

Part No.	Product No.	Dimensions	1	10	25
117604CD	K1771	1.8"L x 2.8"W	\$12.49	\$11.29	\$10.19

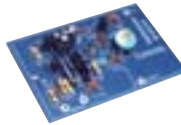

FM Radio Kit

65-piece kit

Easy to assemble – no coils to wind. Receives the complete FM band of 88 – 108MHz.

- With on/off switch, volume control, and LED indicator
- Single adjustment

Includes: 12VDC @ 100mA power supply

Part No.	Product No.	Dimensions	1	10
211772CD	MK118	4.8"L x 3.3"W	\$21.95	\$19.95



One-Chip AM Radio Kit

39-piece kit

• Uses an IC that performs as an RF amp, detector & AGC in an AM radio

Requires: 9V battery (recommend P/N 151095CD, pg 202)

Part No.	Description	Dimensions	1	10	25
125161CD	AM radio kit	4.0"L x 1.3"W x 0.5"H	\$15.49	\$13.95	\$12.59



TV Notch Filters Mini Kit

33-piece kit

Eliminates unwanted TV channels or interference that alters sound and video. Works on cable channels 2 to 22 and 97 to 99.

Part No.	Description	Dimensions	1	10
151167CD	DF-222 TV filter kit	3.2"L x 0.9"W	\$15.95	\$14.49



10 LED Mono VU Meter Kit

36-piece kit

- Instant visualization of audio signal levels
- Easy hook up to a LINE level (LOW input) signal source
- Special input (HIGH input) is provided, which allows direct connection to a speaker output
- Frequency range: 20Hz to 30kHz
- Dot or bar display mode selectable

Requires: 15VDC @ 300mA max. power supply (P/N 189982CD, pg 56)

Part No.	Product No.	Dimensions	Wt. (lbs.)	1	10
147643CD	K4304	2.7"L x 1.4"H	0.3	\$19.95	\$17.95



SALE

Universal Mono Pre-Amplifier

17-piece kit

For audio applications with insufficient input signal.

- Output impedance: 1kΩ
- Max. input signal: 40mV
- Frequency range: 20Hz - 20kHz +/-3dB
- Adjustable output level: 40dB max.

Requires: 10/30VDC @ 10mA power supply (recommend P/N 20626CD, pg 207)

Part No.	Product No.	Dimensions	1	10	25
117612CD	K1803	1.2"L x 1.8"W	\$8.95	\$7.95	\$7.25



1-Watt Amplifier Kit

9-piece kit

Amplifies audio signals for an 8Ω speaker. Use on P/N 125111CD and P/N 147838CD.

- Ideal part for larger projects & battery powered circuits
- Circuit designed around a single TDA7052 IC
- Battery and battery snap not included (recommend P/N 151095CD, pg 202 and 109153CD, pg 203)
- Drives 8Ω speaker (not included)

Part No.	Description	Dimensions	1	10	25
125111CD	1 watt amp kit	.3"L x 1.1"W x 0.9"H	\$6.29	\$5.59	\$4.99



Super Mini 2.5W Audio Power Amplifier

27-piece kit

This circuit has incredibly tiny dimensions. The IC has a pre-amplifier and power amplifier, which can be used separately by cutting a jumper.

- Operating frequency: 60Hz to 15kHz
- Max. output power: 2.5W (4Ω, 12V)
- Short circuit/thermal overload protection

Requires: 4.5-15VDC @ 400mA power supply (recommend P/N 114825CD, pg 56)

Part No.	Product No.	Dimensions	1	10	25
127175CD	K2637	1.7"L x 1.3"W x 1.1"H	\$11.95	\$10.69	\$9.65



7-Watt Amplifier Kit

22-piece kit

- Music output power: 7W/4Ω
- RMS output: 3.5W/4Ω & 2W/8Ω
- Harmonic distortion: 0.05% (1W/1kHz)
- Frequency response: 20 to 20kHz (-3dB)
- Short circuit/overload protection

Requires: 15VDC (8-18VDC) @ 500mA power supply (recommend P/N 155803CD, pg 56); speakers

Part No.	Product No.	Dimensions	1	10	25
127255CD	K4001	2.2"L x 1.4"W	\$13.95	\$12.49	\$10.95



18-Watt Bridged Mono Amplifier Kit

17-piece kit

- Drives 3-8 ohm speakers
- Based on the Hitachi HA13118 amplifier IC

Requires: 12VDC supply (recommend P/N 100095CD, pg 55)

Part No.	Description	1	10
136207CD	18 watt amplifier kit	\$15.59	\$13.95



20-Watt RMS Amplifier Module

- Input signal: 250mV
- Maximum current: 2A
- Output impedance: 4-8Ω (mono)
- Terminals: .100" matching disconnect solderless terminals
- Size: 2.8"L x 2.8"W x 1.6"H

Requires: Power supply: 12V @ 2A (recommend P/N 143714CD, pg 53)

Part No.	Description	1	10
147838CD	E-11 mono amplifier	\$24.95	\$22.49



30-Watt Stereo Power Amplifier

38-piece kit

General purpose stereo amp for audio applications.

- RMS output: dual 15W @ 4Ω or dual 10W @ 8Ω
- Frequency bandwidth: 7Hz to 60kHz (-3dB)
- Separation: 70dB
- Supply voltage: 24VCT @ 2A (recommend P/N 101864CD, pg 47)

Part No.	Product No.	Dimensions	1	10	25
129138CD	K4003	2.8"L x 2.0"W	\$29.95	\$26.95	\$24.49



velleman **Sound Generator Kit** ■ 61-piece kit

- Produces 10 different sounds w/ adjustable speed: guns, sirens, car engines, explosions, tunes, screeching tires, phaser guns
- Push-button keyboard

Requires: 8Ω/1 watt speaker (recommend P/N 102031CD, pg 98): 9V battery (recommend P/N 151095CD, pg 202)



Part No.	Product No.	Dimensions	1	10
127562CD	K4401	2.8"L x 2.8"W	\$29.95	\$26.95

velleman **Metronome Kit** ● 27-piece kit

- Adjustable volume and beats/minute
- LED beat indication
- Incorporated speaker
- On/off switch on board

Requires: 9VDC battery (P/N 151095CD, pg 202)



Part No.	Product No.	Dimensions	Wt. (lbs.)	1	10
157331CD	MK106	2.4"L x 1.6"W	0.1	\$13.99	\$12.79

velleman **Light Sensitive Electronic Cricket Kit**

■ 26-piece kit

Sounds like a cricket when it gets dark!

- Adjustable cricket effect, tone and light sensitivity
- Minimum consumption: 9V/5mA

Requires: 8-15VDC power supply (P/N 100095CD, pg 55) or 9VDC battery (P/N 151095CD, pg 202)



Part No.	Product No.	Dimensions	Wt. (lbs.)	1	10	25
147547CD	MK104	2.5"L x 1.7"W x 1.6"H	0.1	\$14.95	\$13.49	\$11.95

Siren Kit ● 20-piece kit

- Oscillator is off until you press the switch, then a rising tone is produced until a steady value is reached
- If switch is released, tone starts dropping until it cuts off
- Circuit designed around a dual op amp connected as an oscillator and driver



Requires: 9V battery (recommend P/N 151095CD, pg 202)

Part No.	Description	Dimensions	1	10	50	100
125137CD	9V siren	2.0"L x 0.8"W x 0.5"H	\$6.95	\$6.25	\$5.59	\$4.95

Train Sound Generator Kit ● 11-piece kit

- Produces 4 train sounds by switch selection
- Components supplied for operation on 3VDC (includes battery holder for 2 AA batteries), but circuit will operate from 2.4-6VDC (recommend P/N 151087CD 2 each, pg 202)



Part No.	Description	Dimensions	1	10	25
125170CD	4 train noises	1.1"L x 0.6"W x 0.2"H	\$9.49	\$8.59	\$7.69

velleman **Karaoke Kit** ■ 59-piece kit

You can do your "Elvis" impersonation by hooking up this kit between your CD player, MD player, or any other line-level source and your amplifier; and sing along to your favorite Elvis' music. Adjustable microphone level and "vocal reduction" switch reduces original vocals on most stereo surroundings.



- RCA input and output sockets
- ON/OFF switch and led power indicator
- 6.3mm microphone jack that fits most microphones
- Low power consumption: 16mA typical

Requires: 9V battery (recommend P/N 198731CD, pg 202)

Part No.	Product No.	Description	Wt. (lbs.)	1	10
215394CD	MK140	3.9"L x 3.3"W x 1.0"H	0.2	\$15.95	\$14.35

Speech Recording & Recognition Kits

Digital Voice Module

- Selectable 16k/32k/44k bps sampling rate
- 0.5W audio amp on board with volume control
- All components soldered on board
- Plays 16 messages • 1M DRAM on board
- Power requirements: 6-12VDC, 200mA (P/N 100095CD, pg 55)



SALE

Part No.	Mfr. Cross Ref. No.	1	10	25
124871CD	DVM58D	\$74.95	\$67.49	\$60.75

velleman **Voice Activated LEDs Kit** ■ 33-piece kit

Uses sound to activate the flashing of 4 bright red LEDs.

- Power consumption: 0.5mA min./12mA max.
- Adjustable sensitivity

Requires: 8-15VDC power supply (P/N 100095CD, pg 55) or 9VDC battery (P/N 151095CD, pg 202)



Part No.	Product No.	Dimensions	Wt. (lbs.)	1	10	25
147571CD	MK103	2.5"L x 1.6"W x 1.4"H	0.1	\$9.95	\$8.95	\$7.49

Speech Recognition Kit ▲ 42-piece kit

A complete and easy-to-build programmable recognition kit. Program the words you want the circuit to recognize. The heart of this speech recognition kit is the HM2007 IC wherein you can program 40 words @ 0.96 second word length or 20 words @ 1.92 seconds word length. Some of the applications for this kit include: speech controlled appliances and toys, speech assisted computer games, telephone assistance systems, voice recognition security, and speech-to-speech translation.



- User programmable
- Non-volatile memory back-up
- Multi-lingual
- Easily interfaced to control external circuits and appliances

Part No.	Mfr. Cross Ref. No.	Description	Wt. (lbs.)	1	10
208611CD	HM2007U1	Speech kit	0.7	\$119.95	\$107.95

Electronic Locks

Electronic Combination Lock ■ 19-piece kit

- Programmable 4-digit combination lock with separate 9 touch-pad board
- Output: 240VAC 12A relay controls external loads

Requires: 9V battery (P/N 151095CD, pg 202)

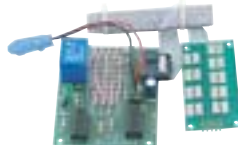

Part No.	Description	Dimensions	1	10
125129CD	Lock kit	3.0"L x 2.5"W x 1.0"H	\$12.29	\$10.99

velleman **Code Lock Kit** ■ 67-piece kit

- Switch an alarm on and off or open door locks
- 3000+ codes possible
- LED indicates state
- Pulse or switch outputs
- Relay contact rating: 5A/220V

Requires: 9-15VDC (P/N 163491CD, pg 55) or 8-12VAC (P/N 100061CD, pg 58) power supply

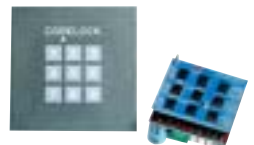

Part No.	Product No.	Dimensions	Wt. (lbs.)	1	10
127554CD	K6400	1.7"L x 1.8"W	0.5	\$25.95	\$23.95

Solar Photon Racer Kit

Build your own solar racer and tap into the power of the sun! This easy-to-assemble kit comes with everything you need, including a high-powered 1V, 500ma, ultra lightweight encapsulated solar cell and high-amp/low-voltage motor for maximum torque and speedy acceleration. Sleek transparent plastic body, made from recycled pop bottles, looks great as is, or add your own custom paint job. The Photon can travel 10 feet in three seconds on a smooth, flat surface, when exposed to full sun.



214738CD

- Difficulty level: beginner
- Size: 8.5"L x 3.8"W x 2.0"H

Part No.	Description	1	10
214738CD	Photon-P (painted)	\$29.89	\$26.99
215183CD	Photon-1 (non-painted)	24.89	21.79

Solar Energy Project Kit

Learn about the renewable energy available with solar power. Experimenter kit demonstrates the power of the solar cell to run an electric motor. Contains motor connected to solar cell, propeller, optical illusion spirals, and informative booklet.



- Difficulty level: beginner

Part No.	Description	1	10
215204CD	Solar energy project kit	\$11.89	\$10.79

Photovoltaic Sun Tracker Solar Kit

This kit gives students and hobbyists a realistic taste of practical applications for solar power. Contains motor, gear train, solar cell, tracker device, and instruction booklet. Booklet explains how to make sundials and three other unusual solar projects.

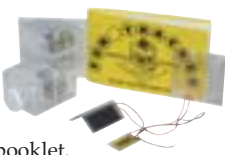

Part No.	Description	1	10
215191CD	Sun tracker solar kit	\$29.89	\$26.99

Motor and Gear Case

Combination motor and gear train in plastic case.

- Operates on 0.5-3.0V @ 0.5V
- Runs at 20mA
- Strong torque @3V: 41 g-cm
- 6 RPM
- Shaft diameter: 2mm
- Size 3.0"L x 2.0"W x 1.5"D



Part No.	Description	1	10
215271CD	Motor and gear case	\$17.39	\$15.75

Solar Motor

- Operates on 0.5-3.0V @ 200mA start-up
- Runs at 80mA no load
- Low stall torque: 25-48 g-cm
- High RPM: 2500-5000 @ maximum efficiency
- Shaft diameter: 2mm
- Motor size: 1.0"Dia. x 1.5"L



Part No.	Description	1	10
215263CD	Solar motor	\$2.89	\$2.69

Solar Clip-On Motion Retail Display

Just clip on to fluorescent lights and when the light turns on, so does your display. Long-life solar motors rotate your display, turning signs counter clockwise. Best for point of purchase in-store advertising.



See Jameco.com for complete details.

Part No.	Description	1	10
215221CD	Clip-on motion retail display ...	\$24.89	\$22.49

Solar Pocket Charger

Charge your batteries with free solar power. Inexpensive, easy and safe to use – completely self-contained unit, no moving parts or cords. Uses satellite type solar cells that produce the highest power to weight ratio. Compact and lightweight, you can carry this charger with you anywhere. Re-energizes carbon-zinc, alkaline, nickel-cadmium (NiCad), and nickel-metal-hydride (NiMH) batteries.

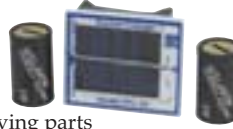

- Size: 3.6"L x 3.1"W x 1.5"D
- Includes: Battery adapter to charge, AA, C, and D type batteries.

Part No.	Description	1	10
215239CD	Solar pocket charger	\$32.89	\$29.69

Solar Button Cell Battery Charger

A convenient and safe way to revitalize worn down button cell batteries used in hearing aids, cameras, calculators, remote controls, clocks, alarms and more. LED indicator lets you know when the battery is being charged. Charges nickel-cadmium (NiCad), nickel-metal-hydride (NiMH), alkaline, mercury, and most zinc air (1.2V-1.5V) batteries.



- Size: 2.3"L x 1.4"W

Part No.	Description	1	10
215247CD	Solar button cell charger	\$16.89	\$15.29

Forever Keychain Light

Miniature rechargeable light lasts for years and you'll never need to change a battery or bulb. Energized by solar cells, it is entirely self-contained. A squeeze turns on the LED emitting yellow light. Perfect for keychain or gift.



- Size: 2"Dia. x 0.5"Thick

Part No.	Description	1	10
215212CD	Forever keychain light	\$19.89	\$17.99

Clear Case with Gears

Motor case & gears Build a 2-speed motor with the parts in this kit. Works with our solar motor (P/N 215263CD, left column).

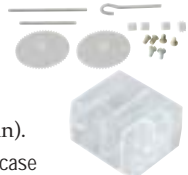

- Includes: Clear SM-15 plastic case

Part No.	Description	1	10
215280CD	Motor case with gears	\$6.89	\$6.29

Mini-Panel Solar Cells

Ready to Use! No Soldering.

Encapsulated mini-panels utilize solar cells similar to those that power our satellites in space, yet they are safe and simple to use. Mini-panels allow for handling without the normal breakage and cell damage associated with fragile solar cells. 6" red/black lead wires attached. Modules may be connected to create different outputs.



200221CD

- Size: 3.8"L x 2.5"W • Connection: lead

Part No.	Prod. No.	VDC @ mA	Size (L x W)	1	10
200205CD	SOL2	0.5 @ 800	2.6" x 3.7"	\$8.99	\$7.99
200221CD	SOL4	2.0 @ 200	3.0" x 3.7"	8.99	7.99
215301CD	4-1.5-200	1.5 @ 200	3.8" x 2.5"	12.79	11.59
215319CD	4-3.0-100	3.0 @ 100	3.8" x 2.5"	14.29	12.89
215327CD	4-6.0-50	6.0 @ 50	3.8" x 2.5"	15.79	14.39

Solar Cell Assortment

Approximately 40 pieces of assorted cells at 0.5VDC. Various sizes and current ratings. Connect in series to increase voltage or connect in parallel to increase current.



Part No.	Description	1	10
215255CD	Solar cell assortment	\$9.89	\$8.99

Photovoltaic Solar Panel

- Output connection: conductive film requiring pressure contact or use of 3M conductive epoxy
- Rated 9.5VDC open circuit; 9VDC @ 0.06A in direct sunlight
- Size: 6"L x 6"W x 0.1"Thick



Part No.	Description	1	10	50
141751CD	0.5W solar panel	\$7.95	\$7.19	\$6.45

Miniature Glass Solar Panel

- Open circuit voltage: 16.5VDC in full sunlight
- Operating temperature range: -5° to +40°C
- Operating voltage: 12VDC @ 3mA
- Size: 3.6"L x 1.0"W



Part No.	Description	1	10	50
171985CD	Glass solar panel	\$7.89	\$7.19	\$6.39



Flexible Thin-Film Solar Panel

- For recharging NiCad, Nickel Metal Hydride and Gel-cell batteries
- Size: 4.5"L x 1.5"W

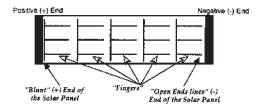

Part No.	Output	1	10	100
171061CD	3VDC @ 40-50mA	\$9.19	\$8.29	\$7.49

Gears and Shafts Kit

Bag of gears, shafts and accessories. Great for science projects. All parts fit 2mm shaft motors.



Part No.	Description	1	10
215298CD	Gears and shafts kit	\$5.89	\$5.29

650nm Line and Dot Laser Diodes

167214CD/143845CD/173243CD:

- Focus adjustable w/ locking set screw
- Wattage: 5mW
- Operating voltage: 3-5V
- Size: 3.3"L x 0.9"Dia.
- One-year warranty

Class IIIa Laser Product



173243CD

143845CD: Line laser module

- Laser line width: 1mm
- Laser fan angle: 60°

173243CD: Cross hair laser diode module

- Laser fan angle: 60°
- Female 2.1mm power connector
- Size: 3.0"L x 0.9"D

143837CD: Module regulated power supply

- Output: 5VDC @ 100mA
- Short circuit protection
- Input voltage: 95-125VAC or 190-250VAC switchable
- Size: 2.0"W x 1.7"D x 9.2"H
- Weight: 0.6 lbs.

143853: Laser module mount

- Built to hold laser diode on target.
- X-Y tilt, θ movement
- Tightening screw for tilt adjustment



143853CD

Part No.	Description	1	10
143845CD	Line laser diode module	\$114.95	\$103.95
143853CD	Laser diode module mount	49.95	39.95
173243CD	Cross hair laser diode mod.	89.95	80.95
143837CD	Regulated power supply	19.95	17.95

Laser Diode Level



- Skew is determined by built-in bubble
- Two magnets at the bottom of the unit for metal to magnet mounting
- Laser wavelength: 650nm
- Threaded mounting hole at the bottom of unit for tripod mounting
- Size: 5.4"L x 0.8"W x 1.4"H

SALE

Includes: Manual, 2 AAA batteries and plastic casing

Part No.	Mfr. Cross Ref.	Laser Type	1	10
169762CD	TI3284E	Line	\$49.69	\$45.19

ALPEC Laser Alignment Tool Kit

This industrial grade laser diode alignment system produces a collimated beam from a 650nm index guided laser. It is an ideal tool for a wide range of low power laser applications such as positioning, alignment, robotic control, and measurement. The system is fully self-contained with power supply, laser diode, and optics. Focal length is fully adjustable.

- Size: 9.0"L x 7.0"W x 2.0"H
- Weight: 1.3 lbs.

Includes: Pushbutton switch, pressure pad switch, 3V lithium battery, universal mount, magnet mount, interchangeable lens cap (cross hair, dot, line) and hard carrying case.



Part No.	Description	1	10
215167CD	Laser alignment kit	\$149.95	\$139.95

ALPEC Laser Pointer w/ Key Ring

- Range up to 150 yards
- 650nm red laser
- One-year warranty

Class IIIa Laser Product



Includes: 2 coin cell batteries

Part No.	Description	Size (L" x Dia.)	1	10
153613CD	Laser pointer	2.1 x 0.5	\$16.95	\$14.95

Glass-Lens Red Laser Diode and Line Generator

133292CD: Laser Diode

Class IIIa Laser Product

This lens design uses 3-element glass to collect almost all the power from the laser diode resulting in a brighter spot than many typical laser applications.

- Operating voltage: 4.0-6.0VDC (recommend P/N 112070CD, pg 54)
- Maximum output: 4mW
- Beam size at 7m: oval - 5mm x 8mm
- Wavelength: 660nm
- Beam divergence: 0.2mrad
- Green LED indicator
- Module size: 2.0"L x 0.5"W



133292CD

134148CD

134148CD: 60° Line Generating Lens

- Adjustable focus range: 50 cm to ∞
- Back focal length: 1.5mm
- Focal length: 8.0mm
- Beam divergence: 2.0mrad
- Lens construction: 3E.3G (glass)
- Fan angle: 60°
- Length at 1 meter distance: 1.7 m

Part No.	Description	1	10	25
133292CD	Glass laser diode	\$44.95	\$39.95	\$35.95
134148CD	60° lens	12.95	11.49	9.95

Laser Diode Module

- Operates on 3VDC @ <5mW
- 670nm wavelength
- Beam diameter: 3.2mm
- Working distance: over 50 meters/yards (daylight), 200 meters/yards (dark)
- Size: 0.9"L x 0.3"Dia.
- One-year warranty



Part No.	Description	1	10	25
131203CD	Laser module, brass...	\$44.95	\$40.49	\$36.45

Laser Diode and Driver

182932CD: Laser Diode

Class IIIa Laser Product

- Optical output power: \leq 5mW maximum
- Operating current: 30mA
- Operating voltage: 2.6V maximum
- Lasting wavelength: 650nm typical
- 5.6mm packaging size
- Beam divergence of 11 degrees from center line maximum



182932CD

SALE

161736CD: Laser driver w/ regulator

- Input voltage: 2.6-6VDC
- Input current: 40mA

Part No.	Description	1	10	25
182932CD	650nm laser diode ...	\$11.95	\$10.79	\$9.69
161736CD	Laser driver	7.95	6.95	6.25

ALPEC Laser Pointer Pens

- Range up to 500 yards

- 670nm red laser

Includes: 2 AAA batteries

Class IIIa Laser Products

Part No.	Description	Size (L" x Dia')	1	10
153605CD	Black pen	5.2 x 0.4	\$19.95	\$17.95
127749CD	Silver brass	5.4 x 0.4	21.95	19.95

Laser Light Show



NEW



Create all different shapes and sizes.

A Laser Light show in the palm of your hands. Push a switch for fascinating, ever-changing laser patterns. This state-of-the-art laser device provides hours of fun for kids from 10 to 70 years young. A great and fun way to teach students about lasers and mechanical resonances. Create your own laser light show while listening and dancing to your favorite tunes. Or hang it around your neck creating your own magical lights. Laser movement can be switched off and can be used as a compact laser point.

- Range: 30 yards free form/500 yards dot point
- Output wavelength: 650nm
- Output power: <5mW
- Includes 3 LR44 batteries and neck strap

Part No.	Description	1	5
223714CD	Black case laser	\$29.95	\$25.95
223706CD	Red case laser	29.95	25.95

The Ultimate Laser Pointer with Dot, Underline, and Arrow Pointer



Choose the point that is perfect for your presentation.

NEW

The most advanced pen-style laser ever designed. No need to buy more than one laser pointer to get your presentation across. With a simple twist of the head, you can transform the powerful 5mW red laser into an arrow, or an underline, or a dot pointer up to 500 yards away. Use the arrow for pointing out details of an image, a dot for general use, and the underline for highlighting important text for maximum impact. Made of brass, and comes with 2 AAA batteries for 3 hours of continuous use and a gift case.

- Range: 100 yards for arrow, 500 yards for dot, 15 yards for underline
- Color: matte black finish
- 650nm red diode laser
- Power: <5mW

Part No.	Description	1	5
223722CD	Laser pointer	\$69.95	\$65.95

Can't find what your looking for? Check our website for additional laser products.
www.Jameco.com

9.8' Optical Voice Link Kit

This kit is the ideal introduction to the science of light transmission through 9.8' optical fiber.

• Weight: 0.6 lbs.

Requires: 9V battery, recommend (P/N 151095CD, pg 20)



SALE

Part No.	Description	1	10
169922CD	9.8' Optical Voice Link Kit	\$39.95	\$36.39

www.Jameco.com

Lab Course and Lab Kit

Experiment guide contains nine fiber optic experiments. Kit contains all the fiber optic and electronic components needed to complete the experiments.

Experiments Include:

- Making a light guide
- Fiber optic transmitter
- Fiber optic cable transmission
- Characteristics of connectors and splices
- Index-matching procedures
- Speed of opto-electronic devices
- Fiber termination techniques
- Receiver design
- Weight: 0.7 lbs.



Part No.	Description	1	10
169914CD	Lab Course and Lab Kit	\$46.89	\$42.29

Fiber Optic Cable-Cutting Tool Kit

Kit contains fiber optic stripper, 25W hot knife professional fiber cutter, water dispenser, rubber pad, 600 grit and 3µm polishing film, replacement blades, ST-connector fiber polishing puck, rugged storage container and instruction booklet.

• Weight: 2.5 lbs.



SALE

Part No.	Description	1	10
170034CD	Fiber Optic Tool Kit	\$105.95	\$94.95

Easy Microcontrol'n

Beginners Guide (Version 4)

Square 1 Publishing A revision of and the successor to Easy PIC'n that covers Peripheral Interface Controller (PIC) PIC16F84, writing programs, interrupts, timing and counting, and much more. (178 pages, 2002)

• Size: 8.5" x 11.0" • Weight: 1.2 lbs.



Part No.	Description	1	10
215061CD	Easy Microcontrol'n	\$29.95	\$26.95

Microcontrol'n Apps

PIC Microcontroller Applications (Version 2)

Square 1 Publishing This book is a revision and/or the successor to PIC'n Up The Pace. Materials covered in the book include talking to a PIC microcontroller with a PC running a terminal, simple data logger and digital voltmeter experiment, PIC16F87x and 10-bit A/D conversion. (437 pages, 2002)

• Size: 8.5" x 11.0" • Weight: 1.7 lbs.



Part No.	Description	1	10
215052CD	Microcontrol'n Apps	\$44.95	\$40.45

Time'n and Count'n

Intermediate Level PIC Applications

Square 1 Publishing The material and information presented in this book previously appeared in PIC'n Techniques book. The more current PIC16F870 is substituted for the PIC 16C63. Topics such as test equipment for timing and counting experiments to using timer 1 / timer 2, and capture/compare/PWM as well as programs are included in this book. (218 pages, 2002)

• Size: 8.5" x 11.0" • Weight: 1.4 lbs.



Part No.	Description	1	10
210489CD	Time'n and Count'n	\$34.95	\$31.45

Serial Communications

Serial Communications PIC Applications

Square 1 Publishing Topics such as asynchronous serial communications, RS242 standard, ASCII character code, bit-bang asynchronous serial communications, synchronous serial communications to name a few are covered in this book as well as tool box modules and applications. (566 pages, 2002)

• Size: 8.6" x 11.0" • Weight: 3.5 lbs.



Part No.	Description	1	10
210497CD	Serial Communications.....	\$49.95	\$44.95

Programming & Customizing PICmicro Microcontrollers

Second Edition

McGraw-Hill Details the features of the PICmicro® and how to use these embedded chips to access and control many different devices. Shows what happens within the PICmicro® when an instruction is executed and how it interfaces with external devices. (1190 pages, 2001)

• Size: 9.2" x 7.3" • Weight: 4.0 lbs.

Includes: CD-ROM and PIC PCB



Part No.	Description	1	10
183046CD	PICmicro Programming	\$49.95	\$44.95

PIC Microcontroller Project Book

Comprehensive Beginner's Guide

McGraw-Hill Provides you with hands-on directions for putting Microchip's RISC-based chips with up to 8k of memory to work. Starting with simple projects and experiments, this book leads you gradually into sophisticated programming techniques. Provides you guidance on getting the equipment you need and programming your chip. (203 pages, 2000)

• Size: 7.3" x 9.2" • Weight: 1.0 lb.



Part No.	Description	1	10
174650CD	PIC Beginner's Guide	\$29.95	\$26.95

PIC BASIC Programming and Projects

Newnes Publications The BASIC language, as used by the most popular PIC compilers, is introduced from square one, with simple code used to illustrate each of the most commonly used instructions. PIC BASIC is the simplest and quickest way to get up and running – designing and building circuits using a microcontroller. (210 pages, 2001) • Size: 6.1" x 9.2" • Wt.: 0.8 lbs.



Part No.	Description	1	10
200168CD	PIC BASIC Programming	\$34.95	\$32.95

The Nuts & Volts of BASIC Stamp

This book is useful for newcomers to BASIC Stamps, and seasoned programmers looking for some hardware and software programming tips. With Nuts and Volts easy going style, the BASIC stamp is presented with a series of articles describing PBASIC source code and circuit hints wrapped around a set of real world applications. Over 70 applications featured in this two volume set. (982 pages, 1999)

• Size: 8.5" x 7.5" • Weight: 3.5 lbs.

Includes: CD-ROM



Part No.	Parallax No.	1	10
202315CD	28165	\$45.95	\$44.79

Programming and Customizing The BASIC Stamp Computer

McGraw-Hill A comprehensive tutorial on the easy-to-use BASIC Stamp single board computer and a primer on electronics. Includes software tools to begin developing PIC applications. (334 pages, 2001)

• Size: 7.4" x 9.0" • Weight: 1.2 lbs.

Includes: CD-ROM



Part No.	Description	1	10
154667CD	BASIC Stamp Book	\$34.95	\$31.49

BASIC Stamp Data Book

Newnes Publishing Covers both the hardware and software of the Parallax BASIC stamp I and II microprocessor operation and design. The basic stamp is built on PC microcontroller hardware and uses PBASIC as its programming language which makes it simple to use and modify for beginners and professionals. (305 pages, 2000)

• Size: 6.0" x 9.2" • Weight: 0.9 lbs.

Part No.	Description	1	10
143651CD	Basic Stamp Data Book	\$34.95	\$31.49

Easy Step'n Version 1.0

Square 1 Publication Provides the experimenter with the know-how to determine important electrical and mechanical specifications of a motor using simple, easy to build test equipment, design and build microcontroller-based control systems, and driver circuits needed to switch the power applied to stepper motors. (199 pages, 2001) • Size: 8.5" x 11" • Wt.: 1.3 lbs.



Part No.	Description	1	10
199700CD	Easy Step'n Version 1.0	\$29.95	\$27.95

Jameco's Low-Price Guarantee

We'll match the advertised price of any like product.

It's that simple.

Programming and Customizing 8051 Microcontrollers

McGraw-Hill Provides you with a complete understanding of the 8051 chip compatibles along with all the information needed to design and debug applications. Covers how to use these embedded chips to access and control many different devices. Includes over 30 experiments, 12 projects and CD-ROM featuring source code and PDF data sheets. (541 pages, 1999)



• Size: 7.5" x 9.2" • Weight: 2.5 lbs.

Part No.	Description	1	10
161402CD	Program/Customizing	\$29.99	\$26.99

The Microcontroller Application Cookbooks

Woodglenn Press - Volume 1

A collection of interface circuits and a reference to circuits and interface code that can be customized for more advanced users. (248 pages, 2000)



• Size: 5.3" x 8.6" • Weight: 0.7 lbs.

Woodglenn Press Volume II

Building on the foundations laid on the first volume, this volume contains schematics with complete part numbers as well as sample "code snippets" that demonstrates how each circuit works. The author has acknowledged Jameco Electronics for providing the components necessary in creating the circuits. (248 pages, 2002)

• Size: 5.3" x 8.3" • Weight: 0.6 lbs.

Part No.	Description	1	10
181681CD	Microcontroller Cookbook Vol 1	\$29.95	\$27.95
212847CD	Microcontroller Cookbook Vol 2	29.95	27.95

The Microcontroller Idea Book

The Idea Book introduces low end embedded microcontroller design. It provides practical designs for use with data loggers, controllers and small computer applications. (277 pages, 1997)



• Circuits, programs and applications featuring the 8052-BASIC single chip computer

• Size: 7.8" x 10.5" • Weight: 1.6 lbs.

Part No.	Description	1	10
126375CD	Micro. Idea Book	\$31.95	\$28.95

Making Your Own Printed Circuit Board Book

JV Enterprises No darkroom or special equipment needed. Shows steps for drilling and shaping your printed circuit board and the materials you will need. (91 pages)



• Size: 8.5" x 11" • Weight: 0.5 lbs.

Part No.	Description	1	10
141524CD	Making PCBs Book	\$19.95	\$17.95

Electronic Circuit Guidebooks

Prompt Publications

Volume 1: Sensors

In this book you will find information needed about typical sensors, along with a large amount of information about analog sensor circuitry. Amplifier circuits are well covered, along with differential amplifiers, analog signal processing and more. (339 pages, 1997)



• Size: 7.4" x 9.3" • Weight: 1.3 lbs.

Part No.	Description	1	10
140732CD	Sensors	\$31.95	\$28.95

IC Design Projects

Prompt Publishing Information of how a handful of versatile ICs work. Gives you information about TTL and CMOS ICs, and how power supplies, op amps and phase lock loops work. It also includes schematic diagrams, a step-by-step guide, parts list, and how to test projects such as battery chargers, 5-volt power supplies, DC motor controls and darkroom timers. (261 pages, 1998)



• Size: 7.4" x 9.3" • Weight: 1.0 lb.

Part No.	Description	1	10
153349CD	IC Design Projects Book	\$25.95	\$23.95

IC Projects for Hobbyist and Technicians

Prompt Publishing Written for hobbyists and technicians who are interested in projects for integrated circuits – projects that you will be able to breadboard quickly and test easily. (212 pages, 1997)



• Size: 6.0" x 9.0" • Weight: 0.7 lbs.

Part No.	Description	1	10
143271CD	IC Projects Book	\$26.95	\$24.25

Linear IC Pocket Book

Newnes Publishing Dealing mainly with linear ICs such as op-amps, pre-amplifiers, power amplifiers, signal-conditioner and power supply regulators, as well as various hybrid types; it is also a compilation of circuits that can be built as they appear, adapted or used as building blocks. (453 pages, 2000)



• Size: 3.8" x 7.8" • Weight: 0.8 lbs.

Part No.	Description	1	10
200133CD	Linear IC Pocket Book	\$24.95	\$22.49

Electronic Pocket Reference

Third Edition

McGraw-Hill Publishing A pocket reference manual that provides definitions, passive component equations and color coding, parameters of standard semiconductors, linear circuits, filters, power supply and regulation, electronic measurement and mathematical tables and formulas. (529 pages, 2000)



• Size: 4.0" x 6.0" • Weight: 0.9 lbs.

Part No.	Description	1	10
174481CD	Electronics Pocket Ref.	\$29.95	\$26.95

TTL Logic Data Book

Texas Instruments Contains specifications and technical information on a broad line of TTL integrated circuits including Schottky TTL circuits. (1240 pages, 1988)



• Size: 6.0" x 8.5" • Weight: 2.6 lbs.

Part No.	Description	1	10
88225CD	TTL Logic Data Book	\$34.95	\$31.49

DSP Filters – Designing & Applying

Prompt Publishing Breaks down design complexity issues through the use of simplified tutorials and step-by-step instructions along with a collection of projects. The author presents the design formulas needed to build the digital equivalent of standard audio filters – low, high, band-pass, and band-stop. Includes the more specialized peaking and shelving filters. (344 pages, 2001) • Size: 7.5" x 9.3" • Weight: 1.4 lbs.



Part No.	Description	1	10
190473CD	DSP Filters Book	\$35.95	\$33.95

Digital Logic IC Pocket Book

Newnes Publishing A handy reference guide to modern 74 series and 4000 series digital logic ICs presents 620 useful and carefully selected circuits, diagrams, graphs and tables. 185 TTL and CMOS ICs provide detailed information and practical applications. Aimed at design engineers and technicians, this pocket book is also useful to amateurs and students. (400 pages, 1996) • Size: 3.8" x 7.8" • Weight: 0.8 lbs.



Part No.	Description	1	10
200141CD	Digital Logic IC Pocket	\$29.95	\$26.95

Robot Builder's Bonanza

TAB Publishing This fascinating guide offers a complete, unique collection of tested and proven project modules that you can mix and match to create an almost endless variety of highly intelligent and workable robot creatures. (753 pages, 2001)



• Size: 7.3" x 9.2" • Wt.: 2.5 lbs.

Part No.	Description	1	10
137171CD	Robot Builder's Bonanza	\$23.95	\$21.45

Robot Builder's Source Book

McGraw-Hill Everything you need to find and acquire common and uncommon robotic parts and supplies. Jameco and over 2500 mail order suppliers and other sources, including local and international businesses all cross-referenced and categorized to make your search quick and easy. (711 pages, 2003) • Size: 8.5" x 10.0" • Wt.: 3.9 lbs.



Part No.	Description	1	10
213461CD	Robot Builder's Source Book	\$19.95	\$17.95

Programming Robot Controllers

McGraw-Hill Tells you everything you need for your robot to perform to specification and expectation – and for you to fully understand how robot controllers are programmed using the versatile Microchip PICmicro 16F27. CDROM included. (456 pages, 2003)



Part No.	Description	1	10
213452CD	Prog. Robot Controllers	\$19.95	\$17.95

CMOS Sourcebook with CD-ROM

Prompt Publishing CMOS gives you the option to use simple technology and eliminate over-design. This book contains a CD-ROM with datasheets for the CMOS 4000 family and information on how to interface CMOS with SCRs and TRIACS. (390 pages, 2001)



• Size: 7.4" x 9.3" • Weight: 1.6 lbs.
Part No. Description 1 10
199654CD CMOS Sourcebook \$39.95 \$37.95

Controlling the World with Your PC

Hightext Publishing Make your PC control stepping motors, monitor fluid levels, or switch appliances on and off! Each of the circuits in this book connects directly to the parallel printer port of your PC and comes complete with a circuit diagram and listings for control software written in Pascal, C and BASIC. (257 pages, 1994)

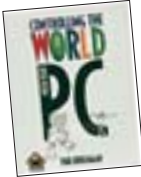

Includes: 3.5" disk
Part No. Description 1 10
116943CD Controlling the World \$34.95 \$31.49

Practical Electronics Book for Inventors

McGraw-Hill Provides information needed for practical use in a format you can understand. With hand-drawn illustrations, this learn-as-you-go guide shows you what a particular device does, looks like and compares with other similar devices. Provides an easy-to-understand overview of basic components, resistors, diodes, capacitors, inductors, rectifiers, amplifiers, voltage regulators, discrete passive and active devices and so on. (604 pages, 2000) • Size: 8.4" x 11" • Wt.: 2.8 lbs.



Part No. Description 1 10
174529CD Practical Electronics \$39.95 \$34.95

Analog and RF Circuits

SALE

Newnes Publishing The author of this book, who is one of the leading analog and RF engineers, uses illustrations and examples rather than mathematical theory, presents a wealth of ideas and tips based on his experience. Essential reading for anyone designing analog circuits. Topics include RF amplifiers, oscillator design and behavior, waveform analysis, optoelectronics, filters, and op-amps. (299 pages, 1998) • Size: 7.4" x 9.2" • Wt.: 1.1 lbs.



Part No. Description 1 10
200150CD Analog and RF Circuits \$49.95 \$45.95

Power Supplies Projects

Prompt Publications Guides you through the fundamentals of power supply design and construction. Includes basics of AC and DC, regulated and unregulated, linear and switching power supplies. (124 pages, 1997)



• Size: 6.0" x 9.0" • Weight: 0.4 lbs.
Part No. Description 1 10
145453CD Power Supplies Project \$19.95 \$17.95

Parallel Port Complete

Lakeview Research A practical, hands-on approach to PCs and their connections to parallel ports. This state-of-the-art book offers many tips on how to get the most out of your parallel port. Enhanced (EPP) and extended capabilities (ECP) types are covered. (343 pages, 1999)



• Windows® 3.1 and Windows® 95 • PC to PC links
• Selecting cables • Size: 7.0" x 10.0" • Wt.: 1.4 lbs.
Includes: 3.5" diskette

Part No. Description 1 10
138261CD Parallel Port Complete \$39.95 \$35.95

Serial Port Complete

Lakeview Research RS-232 and RS-485 are the most versatile, inexpensive interfaces for linking, but the hardware and programming are often misunderstood. This book provides you with everything you need to design, program, install and troubleshoot the links you set up. (306 pages, 1998) • Size: 7" x 10" • Weight: 1.3 lbs.



Includes: 3.5" diskette
Part No. Description 1 10
154771CD Serial Port Complete \$39.95 \$35.95

Electric Motors and Control Techniques

TAB Publishing Explains how different types of motors operate, and how electronic control devices can be used to improve efficiency in a wide range of applications. (294 pages, 1994)



• Size: 7.3" x 9.2" • Wteight: 1.1 lbs.
Part No. Description 1 10
137162CD Electric Motors & Control ... \$19.99 \$17.99

Teach Yourself Electricity and Electronics Handbook

McGraw-Hill This book features conversational writing style, quizzes, self-tests and illustrations that make learning easier. You will be able to design basic electronic circuits, determine waveform combinations, calculate power and impedance and much more. (659 pages, 1997)



• Size: 7.5" x 9.3" • Weight: 3.0 lbs.
Part No. Description 1 10
146982CD Teach Yourself Electricity \$33.95 \$30.55

How to Test Almost Everything Electronic

TAB Publishing Filled with easy-to-follow instructions on how to troubleshoot all types of electronic systems. Learn the many uses of electronic tools, test equipment and troubleshooting techniques using flowcharts. (326 pages, 1993)



• Size: 7.4" x 9.3" • Weight: 1.3 lbs.
Part No. Description 1 10
126199CD How to Test Everything \$17.95 \$16.15

Oscilloscope Guide Book

Prompt Publishing This book's full illustrations and diagrams bring oscilloscopes to life. Learn how to use them to conduct many tests and measurement techniques. This book answers questions about various types of oscilloscopes and how to obtain useful test results. (214 pages, 2001)



• Size: 7.5" x 9.2" • Weight: 0.9 lbs.
Part No. Description 1 10
185404CD Oscilloscope Guide Book \$29.95 \$27.95

Everything You Need To Develop Custom USB Peripherals Book

Lakeview (2nd Edition) This USB Complete book provides an easy-to-use interface for computer peripherals. The book covers topics such as what USB can do, transfer types, chip choices, what's inside a USB controller, writing firmware, how the host communicates and more. (523 pages, 1999)



• Size: 7.0" x 9.0" • Weight: 1.9 lbs.
Part No. Description 1 10
171900CD Complete USB Book \$49.95 \$44.95

Troubleshooting & Repairing Consumer Electronics without a Schematic

TAB Publishing Learn how to locate, test, and repair defective components in audio amplifiers, car radios, cassette decks, TV chassis, compact disc players, power supplies, AM/FM receivers and VCRs. (475 pages, 1997)



• Size: 7.4" x 9.3" • Weight: 1.1 lbs.
Part No. Description 1 10
136080CD Consumer Electronics \$22.95 \$20.95

Take a look at Jameco's line of kits and educational products on pages 200-213.



Corporate Customers

Opening an account is easy!!
Call 1-800-831-4242 for details today.



PAYMENT OPTIONS

Credit Card/Check Cards

We accept VISA, MasterCard, American Express and Discover. No surcharge. Your account will not be charged until your order is shipped. When ordering, please advise name on card and credit card billing address.

Check or Money Order

You may pay by check or money order in U.S. funds, drawn on a U.S. bank.

Open Account

It is easy to open an account with Jameco. Contact us for obtaining open account status.

C.O.D.

Personal checks are accepted. Please add \$7.00 per C.O.D. order. Include the name and address of your bank and your account number.

International Orders

All foreign orders must be prepaid with a credit card (see approved credit cards above), wire transfer, traveler's check, cashier's check or money order drawn on a U.S. bank in U.S. funds only. Please do not send cash. Jameco cannot accept letters of credit as a form of payment.

E-mail: international@jameco.com.

SERVICES

30-Day Money Back Guarantee

If for any reason you are not completely satisfied with your purchase, simply return the product, in its original packaging, within 30 days for a refund, credit or exchange. Parts returned due to customer ordering error may be subject to a restock fee. Call our customer service department at 1-800-536-4316 or visit www.jameco.com to request an RMA#. It should appear clearly on the outside of the box. Returns without an RMA# will not be accepted, and no freight collect packages will be accepted. A completed Jameco customer service form, located on the back of the packing slip, must be included with your return. Books, kits, software, grab bags and special orders are not returnable. Special orders consist of products sold at an OEM quantity discount or products not listed in the Jameco catalog.

Jameco Warranty

Jameco warrants all merchandise against defects in material or workmanship for a period of 90 days from the original purchase date unless otherwise stated in writing by Jameco. If Jameco receives the product considered to be defective within this warranty period and the product is determined to be defective, Jameco will, at its sole option and discretion, either repair or replace the product. The foregoing is your sole and exclusive remedy and states Jameco's entire liability arising out of this warranty. [However, Jameco will transfer to customer whatever transferable warranties and indemnities Jameco receives from the manufacturer of the products. Any claims arising from such manufacturer's warranties shall be the sole responsibility of the manufacturer and not of Jameco.] Moreover, Jameco's limited warranty is void if the damage or defect has resulted from improper customer assembly, failure by customer to follow instruction, product modification, negligent or improper operation, accident, abuse or misapplication. Products returned to Jameco pursuant to this warranty must be returned to Jameco prepaid.

No Other Warranties

The limited warranty above is exclusive and in lieu of all other conditions and warranties for the products and documentation. Jameco makes no other conditions or warranties, express, implied, statutory or otherwise, and expressly disclaims all other conditions and warranties, including but not limited to, implied conditions or warranties of merchantability, fitness for a particular purpose, and non-infringement of the products.

Limitation of Liability

Jameco shall not be liable for any incidental, special or consequential damages for breach of any warranty, expressed or implied, directly or indirectly arising out of Jameco's sale of merchandise, including any failure to deliver any merchandise, or arising out of customer's installation or use, whether proper or improper, of the product, separately or in combination with other equipment, or from any other cause. Products sold by Jameco are not authorized for use as critical components in life support devices or systems.

5 EASY WAYS TO ORDER

Telephone: Toll-Free 24 hours a day!

1-800-831-4242

International orders,

call 1-650-592-8097



24-hour
Ordering
Hotline!

Toll-Free

US/Canada: 1-800-237-6948

FAX:

Brazil: 000-817-455-6119

Columbia: 980-9-136748

Indonesia: 1-803-015-237-6948

Mexico: 001-800-593-1449

New Zealand: 080-044-0470

Other Countries: 1-650-592-2503



Online:

<http://www.jameco.com>



On-line catalog! Our complete offering of over 6,000 products searchable on the Jameco website!

Mail:

E-mail your order to:

sales@jameco.com or fill out

the order form (page 202) and

mail it to us.



In-Person:

Visit Jameco at 1355 Shoreway

Rd., Belmont, CA. Will-call office

hours are 8:00 a.m. - 5:00 p.m.

Monday - Friday



CONTACT INFORMATION

The following services are available at

1-650-592-8097 Monday - Friday from

6:30 a.m. - 5:00 p.m. PST or via e-mail:

- International Sales (international@jameco.com)
- Customer Service (custservice@jameco.com)
- Credit Department (credit@jameco.com)
- Technical Support (tech@jameco.com)

Toll-Free Hotline!

Please call us at 1-800-831-4242.

A Nuestros Clientes en

La Republica Mexicana: Si usted requiere tratar en Espanol y adquirir nuestros productos facturados L.A.B. Cd. De Mexico (libres de Aduana) y enviados al interior del pais via Estafeta, contacte con nuestro Representante y Distribuidor exclusivo;

Proyeccion Electronica de Mexico, S.A. de

C.V. a: General E-mail: info@proyel.com.

Quote E-mail: sales3@proyel.com

Phone/Fax: 01-(55) 5273-5029

Direccion:

Benjamin Franklin No. 166 Desp. 1

Col. Escandon Deleg. Miguel Hidalgo

C.P. 11800 Mexico, D.F.

Los demas paises de Latinoamerica: Ya pronto tendremos servicio en su Region. Si usted tiene alguna duda o comentario respecto a los servicios de Jameco, contacte con la empresa arriba mencionada en la Ciudad de Mexico, ellos le pueden ayudar.

PRICES

Prices are effective 07-14-03. Prices and discounts are subject to change without notice. We are not responsible for any typographical errors in this catalog. Photos are representative; product appearance may vary.

ONLINE INFORMATION

Get answers to frequently asked questions on the Jameco website at:

<http://www.jameco.com>

SHIPPING INFORMATION



Guaranteed Delivery Time for UPS Ground (Business Days)

- | | | |
|--------|--------|--------|
| ① day | ② days | ③ days |
| ④ days | ⑤ days | ⑥ days |

Orders received Mon.-Fri. by 6:00 p.m. Eastern Standard Time will be shipped the same day. Orders received Saturday and Sunday will ship the following Monday (except on holidays). If we are unable to fill your order on the day received, we will send you a gift certificate worth \$5.00 towards your next Jameco purchase. This offer does not apply to orders waiting for credit approval or backordered items.

Options and Rates*



Shipping delivery times are based on working days.

Ground Service

Up to 6 working days for commercial address (up to 9 working days for residential).

Guaranteed delivery times may vary depending on zip code. \$6.50 for 1st 2 lbs.; \$0.74 for each additional lb.

2-Day Air Service

\$12.00 for 1st 2 lbs.; \$1.50 for each additional lb.

Next Day Air Service

• \$21.50 for AM delivery for 1st 2 lbs.; \$1.95 for each additional lb.

• \$16.00 for afternoon delivery for 1st 2 lbs.; \$1.95 for each additional lb.

Priority Mail (USPS)

\$4.75 for 1st lb.; \$1.90 for each additional lb.

Order must be placed before 5:00 p.m. Eastern Standard Time to ship same day.

Jameco reserves the right to rebill shipping surcharges for customer misaddressed packages

* The above rates apply to single box shipments that are less than 50 lbs. Please call for shipping quote on packages greater than 50 lbs.

International Shipping & Handling

Shipping is via courier or postal service, depending on your preference, insurance availability, and the size and weight of your package. Jameco will apply actual shipping charges with a nominal handling charge on all foreign orders. For mail-in customers, please include 25% for shipping charges or call for a shipping quotation. All returns that meet postal requirements must be sent prepaid via air parcel post. All courier shipments to Canada and Mexico require a certificate of origin. Jameco will provide a certificate of origin for a \$25 processing fee.

POLICIES

Confirming Orders

Please do not send confirming orders. If company policy necessitates a confirming order, please mark "CONFIRMING" boldly on the first page of the order.

No Minimum Order

A \$5.00 processing fee will be added to orders under \$20.00.

Order Form

See previous page for Ordering Information

Fax 1-800-237-6948 Order 24 hours/7 days a week!

Jameco, 1355 Shoreway Road, Belmont, CA 94002 Call: 1-800-831-4242 International TEL: 1-650-592-8097 FAX: 1-650-592-2503

1 Ordered By
We will ship to this address unless you enter a different ship to address.

Customer No. _____ VIP No. (see back cover) _____

Company _____

Name of Requisitioner _____ Title _____

Name of Purchasing Agent _____ Title _____

Street Address/PO Box Number _____

City _____ State _____ Zip Code _____

Contact information (please provide all information and check method preferred)
() _____
Daytime phone number - Required for Credit Card Orders

() _____
Fax Number _____

E-mail Address _____

Please check this box if you prefer not to receive special offers via e-mail from Jameco.

2 Ship To (Only required if different)

Company _____

Name _____ Title _____

Street Address/PO Box Number _____

City _____ State _____ Zip Code _____





3 Method of Payment

Prepaid (check enclosed) C.O.D. (\$7.00 service charge)

Net 30 Days (Account must be previously established. Authorized P.O. # required.)

PURCHASE ORDER NO.: _____

Credit Card

Credit Card users only:    

Credit Card Number

Exp. Date: Month Year Name on card _____

Billing Address Street/PO Box _____ City/State/Zip _____

4

ITEM NO.	QTY.	PART NUMBER	DATA SHEETS	DESCRIPTION	PAGE NO.	WEIGHT (LBS.)	UNIT PRICE	TOTAL
1								
2								
3								
4								
5								
6								
7								
8								
9								
10								
11								

	TOTAL WEIGHT	SUB-TOTAL
--	--------------	-----------

5 Please Check Shipping Method Below

Priority Mail (USPS)\$4.75 for 1st lb., \$1.90 for each additional lb.

Ground\$6.50 for 1st 2 lbs., \$0.74 for each additional lb.

2 Day Air Service\$12.00 for 1st 2 lbs., \$1.50 for each additional lb.

Next Day Air Service (AM delivery).....\$21.50 for 1st 2 lbs., \$1.95 for each additional lb.

Next Day Air Service (PM delivery).....\$16.00 for 1st 2 lbs., \$1.95 for each additional lb.

Foreign Shipment via Air Parcel PostShipping approximately 25% of order total. Excess fees will be refunded. Additional shipping methods available

Add \$5.00 processing fee on orders under \$20	
Please Add Applicable Sales Tax (California Only)	
Shipping (See Item 5)	
C.O.D. (add \$7.00)	
Canada and Mexico Certificate of Origin (\$25)	
Credit Memo (please attach)	-
TOTAL	

Some restrictions may apply. See order information (previous page) for other shipping methods and conditions of sale. Shipping rate is based on a single package shipment.

6 **JAMECO** thanks you for Your Order!

FOR OFFICE USE ONLY

_____ / _____

Order Form

Red indicates new products found throughout the catalog.

A

3M PRODUCTS.....	120,122,159
A/D CONVERTERS.....	74
ACCELEROMETER.....	209
ACCESS PANELS.....	187
ADAPTERS	
Audio/Video.....	119,175,194,196
BNC.....	130,131
D-Sub.....	194
Hard Drive.....	172
Keyboard.....	185,194
Modular Telephone.....	195
Monitor.....	194
Network.....	195
Null Modem.....	194
PLCC.....	112
SCSI.....	172
Serial.....	194
Single Binding Post to BNC.....	152
SMA/SMB.....	130,132
Telephone.....	195
Token Ring.....	193
USB.....	182,183
Wall Transformer.....	54-58
ZIF.....	114,201
ADVANCED LINEAR DEVICES.....	180
ALLIGATOR CLIPS/CONNECTORS.....	152
AMPHENOL.....	130
ANTI-STATIC EQUIPMENT.....	159
APC.....	188
APEM.....	101
APPLE/MACINTOSH PRODUCTS.....	175,176,182,192,194,202
ATEN.....	180,182,183,187,190
ATMEL.....	71
AUDIO EQUIPMENT	
Amplifiers.....	210
FM Transmitters.....	210
Headphones.....	170,176
Microphones.....	136,176
RCA Cables.....	119
Speakers.....	137,176
AUTOMOBILE PLUGS.....	59
AUTOMOBILE POWER INVERTERS.....	59

B

BANANA PLUGS.....	152
BASIC STAMP CONTROLLERS.....	200,201
BATTERIES & ACCESSORIES	
Batteries.....	202
Charger.....	203
Holders & Snaps.....	202,203
Lead Acid.....	202
Rechargeable.....	202
BINDING POSTS.....	152
BK PRECISION.....	141,147
BNC CABLES/CONNECTORS/ADAPTERS.....	130,131,151
BNC CONNECTOR REMOVAL TOOL.....	166
BOARDS.....	(see CARDS)
BOOKS.....	214-216
BOTTLE, PUMP.....	158
BOXES.....	58,118,119
BRACKETS/MOUNTING RAILS.....	172,173,183,197,198
BREADBOARDS.....	84,112,113,115
BREAKOUT BOXES.....	150
BUFFER, PRINTER.....	185,186
BUG BOXES AND TRAYS.....	119
BUZZERS.....	136

C

CABINETS/ENCLOSURES.....	58,118,119,187
CABLE CRIMPERS.....	164
CABLE MARKERS.....	122
CABLE SLEEVE.....	122
CABLE STRIPPERS.....	163,164
CABLE TESTERS.....	150,192
CABLE TIES & CLAMPS.....	122,123
CABLE, ASSEMBLIES AND BULK	
Adapter.....	184
Audio.....	119,172
BNC.....	131,151
Break-Out Box.....	150
Category 5 (UTP) Network.....	193
Category 6.....	192
Centronics.....	184
Coaxial.....	121

DB25-Pin Extension.....	184
Extension.....	172,184
Fiber Optic.....	203
Floppy Drive.....	172
F-Type Coaxial.....	132
Hard Disk Drive.....	172
IEEE 488/1284/1394 Cable.....	183,194
Keyboard.....	185,186
Management.....	122,123,192
Modem.....	184
Modular Telephone.....	195
Monitor.....	184,186,194
Mouse.....	186
Network.....	193,195
Null Modem.....	184
Panel Bracket.....	172
Power Cords.....	49,50,63,188
Printer.....	183,184,194
RCA.....	119
Retractable.....	183,190
Ribbon.....	121,172,181
SCSI.....	172
Serial.....	184,194
Shielded.....	121,181,184
SMA/SMB.....	132
Switch Box.....	184,185
Telephone.....	195
Testers.....	150,184
Ultra DMA 66.....	172
Universal Serial Bus (USB).....	183
Video, RGB.....	184
CAIG CHEMICALS.....	117
CALIPERS.....	167
CAMERAS AND ACCESSORIES	
Antennas/Boosters.....	197
Board.....	196
CCD.....	196-198
Dome.....	198
Enclosed.....	196-198
Infrared.....	198
Lenses.....	196-198
Mounting Brackets and Housings.....	197,223
Pan & Tilt.....	197
Siren.....	198
Transmitters/Receivers.....	197
USB.....	195
Wireless.....	197
CAPACITORS	
Assortment/Kits/Grab Bags.....	109,111
Ceramic.....	85
Ceramic Disc.....	87
Dipped Tantalum.....	88
Electrolytic, Axial.....	87
Electrolytic, Large Can Aluminum.....	86
Electrolytic, Radial.....	86
Kits.....	111
Memory Back-Up.....	88
Monolithic, Ceramic.....	87
Mylar.....	88
Silver Mica.....	88
SMT, Cer. Chip/Alum Electrolytic.....	85
Tantalum.....	85
Trimmer, Ceramic.....	88
CAPITAL ADVANCED TECHNOLOGIES.....	84
CARDS, COMPUTER	
Camera Boards.....	196
Controller.....	179,180
Data Acquisition.....	181
Diagnostic.....	192
Game.....	178
Graphics.....	175
Hard/Floppy Disk Drive Controllers.....	179
Input/Output.....	178,179
Interface.....	178
Network.....	190,191
Oscilloscope.....	140
Parallel.....	178,179
Printer.....	179
Programmer.....	201
Prototyping.....	112-114
SCSI.....	179
Serial.....	178,179
USB.....	182
Video Capture.....	175
CD-ROM DRIVES & ACCESS.....	172,173
CHEMICAL CLEANERS & ACCES.....	117
CHOKES.....	91
CIRCUIT BOARD MNTG HARDWARE.....	118,120
CIRCUIT BOARDS.....	113,117
CLAROSTAT.....	90
CLEANERS/DEGREASERS.....	117

CLIPS

Alligator.....	152
Battery.....	203
Test.....	69,151
CLOCK CHIPS.....	77
CLOCK MODULES.....	77
CLOCK/TIMER KITS.....	207
CLOCKS/TIMERS.....	154
COMPONENT ASSORTMENTS	
Carbon Film Resistors.....	89,110
SMD Resistors.....	85
COMPONENT CABINETS.....	119
COMPUTER	
Accessories.....	2,173
Boards/Cards.....	170,175,178-182,187,191,192,200,201
Brackets.....	172,173,183
Cables, Int./Ext./Network.....	172,184-186
Cameras.....	175,196-198
Cases/Enclosures.....	173,187
CPU Fans.....	171
CPUs/MPUs.....	69
Data Acquisition, Cards/Software.....	181
Drives, Floppy/Hard/CD-R/Thumb.....	173,182
Fans.....	171,173
Hardware/Brackets/Rails.....	173,183
Industrial.....	180,181,187
Keyboards.....	177
Keypads.....	177
Kits/Grab Bags.....	109
Lights.....	2,174
Math Coprocessors.....	69
Memory Chips.....	170
Mice.....	176
Monitor.....	175,196
Motherboards.....	170
Oscilloscope Cards.....	140
Power Cords.....	49,50,188
Power Supplies.....	169
Prototype Boards.....	84,112-114
SIMMs & DIMMs.....	170
Trackballs.....	176,177
Video Cards.....	175
Video RAM.....	69
CONNECTORS	
Amphenol.....	130
ATX.....	135
BNC.....	130,131,193
Card Edge.....	127
Centronics, IDC/PCB Right Angle.....	126
Centronics, Parallel Interface.....	126
Coax.....	130,131
DIN.....	126
D-Sub, Hardware/Hoods/Crimp Housing.....	124,125
D-Sub, IDC/Solder Cup.....	124,125
D-Sub, PC Mount, Right Angle/Straight.....	124,125
Gender Changers.....	183,194
Headers.....	126-128,133,135
Housings, Square Pin.....	127,135
IDC Plug & Socket/Wire.....	123,126,127
MCX/MMCX (AMPHENOL).....	130
Modular/Telephone.....	193,195
Molex.....	134
Network.....	191,193,195
Pins, Crimp/Power.....	124,134,135
Power.....	134,135
RCA Jacks.....	119
Reader Receptacles.....	126
SCSI III.....	126
Shorting Blocks.....	128
SMA/SMB.....	132
Telecom Splice.....	193
Telephone.....	193,195
Terminal Blocks.....	133
Token Ring.....	193
USB.....	127
CONSUMER PRODUCTS.....	168,174,175,199
CONTROLLER CARDS HD/FDD.....	179
CONTROLLERS	
Micro.....	70,71,200,201
Motor.....	64,201,207
PIC.....	70,71
Robotics.....	200,201
CONVERTERS.....	178,180,186
CONVERTERS, DC-DC	
Encapsulated.....	36-45
Enclosed.....	42-45
Non-Isolated.....	35
Open Frame.....	38-41,44-45

COOLERS, THERMOELECTRIC/CHIPS.....	171
CORDS, POWER.....	49,50,188
COUPLERS, SHAFT.....	204
CPUs.....	69
CRIMPING TOOLS.....	164
CRYDOM RELAYS.....	108
CRYSTALS/OSCILLATORS.....	82
CURRENT CLAMP/MULTIMETER.....	150

D

D/A CONVERTERS.....	74
DALLAS SEMICONDUCTORS.....	69,77
DATA ACQUISITION.....	181
DATA BOOKS.....	214-216
DATA LOGGERS.....	180
DC POWER SUPPLIES 6-33,46,51-53,115,169	
DC/GEARHEAD MOTORS.....	66,67
DC-AC INVERTERS.....	59
DC-DC CONVERTERS.....	35-45
DESOLDER STATION & EQUIP.....	155,156,158
DIGITAL I/O MODULES/CARDS.....	105,181
DIGITAL LABS.....	115
DIGITAL MULTIMETERS.....	139,141-143,145-148,150,153,154
DIGITAL OSCILLOSCOPES.....	138,139,140
DIGITAL PANEL METERS.....	98
DIGITAL POWER.....	17
DIN-RAIL PRODUCTS.....	46,224
DIODES	
Germanium.....	80
Infrared (LEDs).....	95
Kits/Grab Bags.....	109,111
LED Displays.....	93
LEDs.....	94,95
Rectifiers, Bridge, SCR.....	79,80
Surface Mount.....	84
Switching.....	80
Transient Voltage Suppressor.....	80
Triacs.....	80
Zener.....	80
DIP SWITCHES.....	103
DISPLAY, VIDEO TEXT.....	196
DISPLAYS, LED & LCD.....	93,98,99
DRILL BITS.....	166
DRIVES, COMPUTER	
Accessories.....	172,173
Cases/Enclosures.....	173
CD-ROM.....	173
Floppy.....	173
Hard.....	173
PCMCIA.....	187
Thumb Drives.....	182
DVM (DIGITAL VOLTMETER).....	180

E-F

EDUCATIONAL ELECTRONIC LABS.....	115
EE TOOLS.....	116
EEPROMS.....	68
ELAB.....	74
ELECTRONIC KITS.....	107,200,204-212,214
EMI SUPPRESSION CORE.....	48
ENCLOSURES.....	58,118,119,181,187
ENTRELEC.....	46,133
EPROM ACCESSORIES.....	116,159,202
EPROM PROGRAMMERS/ERASERS.....	116
EPSON.....	77
ESP SMT TOOLS & ACCESSORIES.....	84
ETHERNET PRODUCTS.....	190,191
FANS	
AC Tube-Axial.....	62,63
Brushless DC.....	60,61,62
Cooling System.....	171,173
Cords.....	63
CUP Heat Sink w/ Fan.....	171
Filters.....	63
Guards.....	63
Hard Drive.....	173
PC.....	171
FAX/MODEMS.....	190
FEET.....	120
FIBER OPTICS.....	127,214
FILES.....	165
FILTERS,PWR. ENTRY/LINE/AC PLUG.....	48
FIREWIRE CABLES.....	183
FISH TAPE.....	165
FLASHLIGHTS.....	167
FLOPPY DRIVES/ACCESS.....	172,173
FLUKE TEST EQUIPMENT.....	139,143,142,148
FLUORESCENT LAMPS.....	96



Product Index

Red indicates new products found throughout the catalog.

FLUX, ROSIN PASTE.....	158
FREEZER, AEROSOL.....	117
FREQUENCY COUNTERS.....	138,141
FUME EXTRACTOR & ACCESS.....	157
FUNCTION GENERATORS.....	138,141
FUSES	
Clips.....	92
Fuses.....	92
Holders.....	92
Resettable Fuses.....	92

G-H

GALS.....	71
GEARS.....	204
GENDER CHANGERS/ADAPTERS.....	183,194
GENERATOR, TELEPHONE RINGER.....	190
GIPB (IEEE-488)	
Cables.....	194
Cards, PC.....	180
GLUE GUN & STICKS.....	165
GRAB BAGS.....	109,119
GRAPHICS CARDS.....	175
GROUNDING/STATIC CONTROL.....	159
HALL EFFECT SENSORS.....	105
HANDY BOXES.....	58,118,119
HARD DISK DRIVES/ACCESS.....	172,173
HARDWARE	
Cable Mounting.....	122,123
Computer Brackets.....	172
Drive Mounting.....	173
Fan Guards.....	63
Feet.....	120
Handles.....	120
Heat Sink Mounting.....	77
Kit.....	109,111
Knobs.....	119
LED Mounting.....	96
PCB Mounting.....	118,120
Prototype Enclosures.....	118
Screws, Nuts, Washers.....	118,120,125
Spacers.....	109,118,120,125
Standoffs.....	120
HEADER PLUGS.....	127
HEADERS.....	126,128,133
HEADSETS/HEADPHONES.....	3,170,171,176
HEAT GUNS.....	123
HEAT SHRINK TUBING.....	123
HEAT SINKS	
486/Pentium Heat Sink & Fan.....	171
Clip on.....	158
Compound.....	77
CPU.....	171
Mounting Kits.....	77
TO-3, TO-218, TO-220.....	77
HEMOSTAT.....	165
HIGHLY ELECTRIC SWITCHES/SENSORS.....	102,105
HOBO DATA LOGGERS.....	180
HOME OFFICE.....	174
CD Printer.....	174
Printer/Fax/Scanner/Copier.....	174
Shredders.....	174
HOODS, D-SUB.....	125
HUBS.....	182,190,191

I

I/O CARDS.....	178,179,181
I/O MODULES/MOUNTING BOARDS.....	105
IDEAL PRODUCTS (Tools).....	163,164
IEEE 1284 CABLES.....	194
IEEE 1394 CABLES (Firewire).....	183
IEEE 488 (GIPB)	
Cables.....	194
Cards, PC.....	180
INDUCTORS, TOROID.....	91
INDUSTRIAL COMPUTING.....	187
INFRARED	
Cameras.....	198
Diodes.....	95,127
Illuminator Kit.....	208
Kits.....	208
Remote Control Modules.....	208
Thermometers.....	154
USB Transceiver.....	183
INPUT DEVICES	
Accessories.....	184-186
Keyboards/Keypads.....	177
Mouse/Pointing Devices.....	176
INSPECTION SET.....	166

INTEGRATED CIRCUITS	
4000-CMOS (DIP/SMT).....	71,72,83,110
5000 Series.....	77
6500 Series/Commodore.....	69
6800/68000 Series.....	70
7400-TTL (DIP).....	71,72,109,110
74AC-TTL (DIP).....	72
74ACT-TTL (DIP).....	72
74AHC-TTL (DIP).....	72
74AHCT-TTL (DIP).....	72
74C-TTL, CMOS (DIP).....	72
74HC-TTL, CMOS (DIP/SMT).....	73,83
74HCT-TTL, CMOS (DIP).....	73
74LS-TTL (DIP/SMT).....	73,74,83,109,110
74S-TTL (DIP).....	74
8000 Series.....	70,71,74
9000 Series.....	74
A/D & D/A Converters.....	74
Assortment.....	109,110
Atmel (AT89C Series).....	71
Basic Stamps/Accessories.....	200
Clock Chips.....	77
Clock Modules.....	77
CMOS Devices (DIP/SMT).....	71,83
CMOS Encode/Decode, Remote Control.....	74
CMOS PIC Microcontrollers.....	70
Converters.....	74
CPUs/MPUs.....	69
Dallas Semiconductors.....	69,77
Decoder/Encoder Chips.....	74
Development Tools.....	84,166
Digital Interface.....	74
DIMM Modules.....	170
Dynamic & Video RAMs.....	69
EDO Memory.....	170
E-Lab Digital Interface.....	74
Embedded Microcontrollers.....	200
EPROMs & EEPROMs.....	68
EPSON.....	77
Flash Memory.....	68
GALs and PALs.....	71
Holtek.....	74
ISD Voice Chips.....	69
Kits.....	110
Linear Series (DIP/SMT/TO).....	74-77,83,110
Math Coprocessors.....	69
Maxim Linear.....	74
Memory Chips.....	69
Memory Modules.....	170
Microchip.....	70
Microcontrollers.....	70,71,200
Microprocessors.....	70
Optoisolators.....	81
PALs and GALs.....	71
PEEL ICT CMOS.....	71
Pentium/Processor Chips.....	69
PIC.....	70
PROMs.....	68,74
RAM, Dynamic.....	69
RAM, Static.....	69
RAM, Video.....	69
Servo & Stepper Motor Controller.....	74
SIMMs.....	170
SMT.....	83
Sockets.....	109,110,128,129
Static RAM.....	69
Storage Tubes.....	159
Surface Mount.....	83
Test Clips.....	69
UARTs.....	69
V20 Chip.....	69
Voice Chips.....	69
Voltage Regulators.....	75,83
Z80 Series.....	69
INTEGRATED POWER DESIGN.....	11,13,21
INVERTERS.....	59
ISOCOM OPTOISOLATORS.....	81

J-K

JACK SCREWS/HEX NUTS.....	120,125
JOYSTICK ADAPTER, USB.....	182
JUMPER LEADS.....	115
KESTER SOLDER & ACCESSORIES.....	158
KEYBOARDS.....	177
KEYCHAINS.....	213
KEYPADS.....	104,127,177
KITS, COMPONENTS	
Assortment.....	110
Capacitors.....	109,111
CMOS, CD4000 Series.....	110

Diodes.....	109,111
Grab Bags.....	109,119
Hardware, Mounting.....	109,111
IC Kit, 7400 Series.....	109,110
IC Kit, 74LS00 Series.....	109,110
IC Sockets.....	109,110
LED Hardware.....	110
LEDs.....	109,110
Linear ICs.....	109,110
Potentiometers.....	109,111
Refills.....	110,111
Resistors.....	89,109,110
SMD Resistors.....	85
Switches.....	109,111
Transistors.....	109,111

KITS, ELECTRONICS

Audio Transmitters and Amplifiers.....	210
BASIC Stamp Programming.....	200
Clock.....	207
Electronic Locks.....	214
Fiber Optics.....	211
Infrared Transmitters and Receivers.....	208
Lasers.....	213
Liquid Level, Distance and Light.....	206,209
Motor Controller.....	207
PC Photo Etoh.....	117
PCB Design Kit.....	117
Power Supply.....	207
Relay Controller.....	208
Robot Kits.....	201,205
Solar.....	205,212
Sound Generation and Detection.....	211
Speech and Recognition.....	211,224
Test & Measurement.....	209
Timers.....	207
Velleman.....	205-211
KNIFE SET.....	165
KNOBS.....	119
KYOTO (Relays).....	108

L-M

LAMPS	
Fluorescent.....	96
Incandescent.....	96,97
Magnifier/Desktop.....	167
Neon.....	96,97
Panel Mount.....	96
Power Supplies.....	96
LAPTOP PRODUCTS	
Cables.....	49
Cards.....	182,191
DVM (Digital Voltmeter).....	180
LASER	
Accessories.....	213
Diodes.....	213
Kit.....	213
Levels.....	213
Pointer.....	213,224
Tachometer.....	153
LCD DISPLAYS/MODULES.....	98,99,196
LCR METERS.....	148
LEADS, TEST.....	144,151,152
LED HARDWARE.....	96
LEDs	
Accessories/Hardware.....	96,109,110
Cable Assemblies.....	96
Clusters.....	93
Displays.....	93
High Output.....	95
High Power.....	95
Infrared.....	95,208
Kits/Grab Bags.....	109,110,208
Ledtech.....	95
Panel Indicators.....	96
Power Indicators.....	96
Standard Output.....	94
LEDECH.....	95
LENSES (Camera).....	196-198
LIGHT METER, DIGITAL.....	153
LINE SEPARATOR, AC.....	150
LIQUID LEVEL SENSOR/CNTRLR.....	105,209
LOCK BOXES.....	198
LOGIC PROBE AND PULSER.....	150
MACINTOSH PRODUCTS.....	173,175
.....	176,182,192,194,202
MAGNIFIERS.....	167
MAGNIFYING GLASSES/LAMPS.....	167
MARKERS.....	122,192
MATH COPROCESSORS.....	69

MEAN WELL	
Converters.....	36-45
Enclosed.....	44-45
Power Supplies.....	6-33,46,51,52
MEMORY.....	170
Batteries.....	202
Capacitors.....	88
DIMM.....	170
EDO.....	170
SIMM.....	170

METERS

Accessories.....	153
Benchtop.....	148
DMM.....	142-148,153
Environmental.....	153
Temperature/time.....	153
METEX TEST METERS.....	139,141,144-146,148
MICE AND ACCESS.....	176
MICROCONTROLLERS.....	70,71,201
MICROMETER.....	167
MICROPHONE	
Cartridge/Condenser.....	136
Headset.....	170,176
PC Desktop.....	176
Wireless.....	136
MICROPROCESSOR CRYSTALS.....	82
MICROPROCESSORS.....	69,70,200
MODEMS/FAX.....	190
MODULAR JACKS & ADAPTERS.....	193,195
MODULATORS.....	196
MOLEX.....	134
MONITOR.....	175,196
MONITOR STAND/BRAKETS.....	198
MONITOR TESTER.....	192
MOTHERBOARDS.....	170
MOTION DETECTOR.....	206
MOTOR CONTROLLERS.....	64,201,207
MOTORS	
DC.....	66
Geared.....	67
Servo/Radio Controlled.....	204
Shaft Couplers.....	204
Stepper.....	65
Stepper Controllers.....	64,207
Vibrating.....	66
MOUSE PAD.....	176
MULTI TOOLS (pocket).....	168
MULTIMEDIA.....	175,176
MULTIMETER TEST PROBES.....	144,151,152
MULTIMETERS.....	142-148,150,154
MUSCLE WIRE.....	206

N-O

NETWORK PRODUCTS.....	190-193,195
NIC CAPACITORS.....	85
NUTS.....	120,125
OMRON.....	102,104,106-108
OPTICAL SWITCHES.....	81
OPTOELECTRONICS.....	81
OPTOISOLATORS.....	81
OSCILLATORS/CRYSTALS.....	82
OSCILLOSCOPE PROBES.....	139,140
OSCILLOSCOPES.....	138-140

P-R

PALs.....	71
PANAVISE.....	126,159
PANEL METERS.....	98
PARALLAX.....	71,200,201
PATCH CORDS.....	152,193
PATCH PANELS.....	192
PC BOARDS/EXTENDERS.....	112-114
PC PHOTO ETCH.....	117
PCB DEVELOPMENT TOOLS/ACCESS.....	117
PCI CARDS.....	112,175,178-182,187,191,192
PEELS.....	71
PERSONAL SECURITY.....	198,199,223
PHONES.....	3
PHOTO TRANSISTORS.....	81
PHOTOCELLS.....	99
PIC MICROCONTROLLERS.....	70,71,114
PIN INSERT/EXTRACT TOOLS.....	134
PLUGS	
Banana.....	152
DIN, IDC, DIP.....	126,127
Power Entry.....	48
Power, Low Power.....	59
POMONA.....	140,151,152

Manufacturer Index

A

3M	120, 122, 159, 168
Aavid	77
ACDC Electronics	46
ACI World	53
Adda	60, 61, 63
Advanced Linear Devices (ALD)	186
AEEC	48, 147
Aldenwrench	3
Alpec	213
American Media	169
American Zettler	108
AMP	124
Amphenol	130
Ampire	99
AMS	187
APC	188
API	169
APEM	101
APS	169
Aries Electronics	128
Aromat	108
ART	116
Artesyn	6-9, 12-14, 20-21, 24-25, 31-32, 35, 38-41, 44-45
Astec	8, 16, 20, 28, 40, 44, 169
AT&T	190
Atari	53
ATEN	180, 182, 183, 186, 190
Atmel	71
Ault	51, 52
Autech	6, 8, 10, 12, 14
AVerMedia	175
Axiom	180

B-C

Bellin Dynamic Systems, Inc.	84
BelMerit	142, 147
BK Precision	141, 142, 147
Black Magic	190
Boca Semiconductor	78, 79
Bomar	195
Boston Acoustics	176
Bourns	90
Bussman	189
Caig Laboratories	117
Capital Advanced Technologies, Inc.	84
Cebek	207, 210
Cheng	61
Cherokee	24, 28
China Semiconductor	93, 94
ChipQuik	84
Clare	108
Clarostat	90
Climax	204
Cobra	59
COBY	176
Common Wealth	60-63
Compaq	169
Cosmo	108
Crossbow	209
Crydom	108

D-E

Dallas Semiconductor	77
Datak	117
Datel	44
Delta	10, 14, 169
Digital Power	10-13, 16-17, 24-25, 28-29
Dinkle	133
Dolphin Peripherals	179
Duracell	202

DVE	10, 51
EE Tools	116
E-Lab	74
Elpac	53
Emaos	169
ENCAD	12
Enhance	169
Entrelec	133
Enzer	3
EOS	16, 24
Epson	77
ESP	84
Etasis	169
Eveready® Energizer®	202
Everglow	51
Excel Cell Electronics	108
Excell	103
Extch	115, 142, 147-149, 153, 154
EZ Digital	138, 139, 141, 148, 149

F-H

Fairchild	78, 79
Fellowes	174
Fluke	139, 140, 142, 144, 148
Fortron	10
Fujikura	105
Fujitsu	108
Fulltech	62, 63
Gatron	53
GBM	65
General Electric	167
General Semiconductor	80
Globe Motors	61, 62
GlobTek	22, 53
Golden Systems	169
Gordos	105
Grayhill	103, 104
Guardian	67
Han Kuk	106
Hanlong	84, 163, 164
Hewlett Packard	93, 94, 174
Hi-Lo Systems	116
High Power	169
Highly	102, 105
Hightext	216
Hipro	169
Holtek	74
Honeywell	102
Hsiang Neng	67

I-L

Ideal	163
IERC	77
Innovative	63
Intel	69, 191
Integrated Power Designs	10-13, 20-21
Iowa Thin Film Technologies	200
ISD	69
Isocom	81
Jamicon	60-62
JKL	96
Johnson Electric	66
JV Enterprises	215
Keltron	53
Kensington	2, 189
Kerr Automation Engineering (KAE)	64, 74
Kester	156
Kulka	133
Kynar	121
Kyoto	108
L & C	169
Lakeview Research	216
Lambda	16, 28, 44

Leap*	116, 178
Ledtech	93, 95
Ligitek	93
LiteOn	93, 94
Logic Concept	169
LZR	53

M

Mabuchi Motor	66
Macally	176
Mastech	142, 146
Matrix Orbital	98
McGraw-Hill	214, 216
Mean Well	6-33, 36-46, 51, 52, 169
Measurement Computing	180, 181
MechaTronics	62
Metex	139, 141, 142, 144, 145
Micro Engineering Labs	114
Microchip	70
MicroMint	71
Millenium	202
Mission Technology	140
Mitsumi	66
Molex	134
Mondotronics	206
Motorola	105
Mountain Switch (Xicor)	101

N-P

Namiki	66
National Semiconductor	78, 79, 93, 94
NEC	108
NetGear	191
Newnes Publishing	214-216
NIC	85
Nichibo	66
Nidec	60-62
NMB	66
OK International, Inc.	129
Omron	102, 104, 106, 108
Onset Computer Corporation	180, 181
Operating Tech	66
Optek	81
OPTO 22	108
Optrex	99
OST	133
OWI	204, 205
PABST	62
Panaflo	61
Panasonic	93, 173
Panavise	159
Parallax	200, 201
Phihong	8, 10, 52
Philips	108
Phoebe	190, 191
Pomona	140, 151, 152
Pontech	64
Potrans	51
Power Cube	44
Power One	8-9, 16-17, 20-21, 24-25, 30-31, 38-39, 44-45
Powerware	189
PREM	50
ProbeMaster	140
Prompt Publications	215, 216
Protek	138, 140

Q-S

Qtronix	176, 177
Quiklink	190
RAF Elec. Hardware	120
Rayex	106

RMV Electronics	64
ROHM	93
Rotron Comair	62
Samsung	8, 9, 78
Scott Edwards	64, 98
Senix	209
Sennheiser	3, 171
Sensory	211
ServoFlo	105
Sharp	108
Shicoh	60
Siliconix	78, 79
Shin Mei	108
Shindengen	67
Skynet	6, 8, 10
SL Waber	188
SMK	196
Solution Cubed	201, 204, 207
Sony	173, 196
Soyo	170
SPI	169
Sprague	78, 79
Square 1 Publishing	214
SSI	22, 28
ST	6
Star Motor	66
Sun Magnet	67
SUN Microsystems	177
Sun Power	169
Sunon	60-63
Super Mac	6

T-U

Tab	66, 215, 216
Tamura	6
TEAC	173
Tech Spray	117
Tech Tools	201
Techflex	122
Teledyne	108
Tempest	202
Texas Instruments	78, 79, 93, 94, 215
TGR	169
Thermalloy	77
TODD	28
Toyo	60, 62
TPI	139
Trimag	169
Tripp Lite	189
Trisys	98
UMEC	52
Universal Microelectronics	36, 42
US Robotics	171
UVP	116

V-Z

VCC	96
Velleman	140
Vishay	80
VL	98
Volgen	6-11
WAHL	123, 155
Wakefield	77
Wavetek/Meterman	141-144
Weller	155, 158, 224
Westinghouse	52
Woodglen Press	214
Xcelite	162, 163, 166
Xtreme Power	169
XYTronic	155-158
ZIP-LINQ	183

Never Get Locked Out Of Your Vehicle Again

With StorAKey you can keep your spare keys safely locked away. It pays for itself with just one loss of keys or a call to the locksmith. A better solution than magnetized-type key storages. Ideal to store keys for commercial use where multiple people use forklifts, trucks, or heavy-duty construction equipment. Save money on long term airport parking by having a family or friend park your vehicle in the airport parking lot a day before you arrive. Keys are easily accessible in this strong, weatherproof casing made of zinc alloy that never rusts or deforms. The case also has an interlocking faceplate (that prevents unauthorized entry), spring steel clamp, and a weather tight protective face cover. Pushbutton keys are easy to operate or to reset combinations.



Part No.	Description	1	5
223925CD	Auto lock box	\$39.95	\$35.95

Quick and Easy Spare Key Storage



Holds up to five keys



Provide controlled & temporary access to service personnel to your business or home

Quick and easy way to prevent lockouts while still providing easy access to your business or residence. A safe alternative to hiding a key under your mat or flowerpot. This keybox attaches securely to a wall, in plain view, and can hold up to 5 keys. The easy pushbutton combination lock with protective cover prevents your keys from being stolen and from the harsh elements. Ideal for business use to provide access to secure areas like tool cages, construction sites, and computer rooms. Includes protective weather cover.

Part No.	Description	Color	1	5
223941CD	Wall mount lock box	Clay	\$39.95	\$35.95
223933CD	Wall mount lock box	White	39.95	35.95

Mount your video camera almost anywhere.

As steady as a tripod, the Window Camera Mount lets you anchor that video camera to any glass surface at any height.

Mount your video or CCTV camera on any window or other non-porous surface, and capture what you've never been able to before. This heavy-duty metal mounting bracket attaches securely to any glass surface with a strong lever-activated 3.25" neoprene suction cup. Mount your camera onto the tripod-style screw. Adjust to any position, and you're ready to shoot hands-free. It's perfect for temporary surveillance of your business or home. For cameras up to 3 lbs.

Part No.	Description	1	5
222746CD	CCTV camera window mount	\$39.95	\$34.95

4000-Count Auto-Range Pocket Multimeter

Spend \$26.95 and save even more! How? Think about the time you spend searching for a DMM each year. Just keep a spare unit at your desk, in your tool-case, or in the repair truck; and you won't have to search elsewhere when you need to take a measurement! This affordable auto-ranging pocket multimeter features 4,000 count resolution on a 3-3/4 digit display, making it ideal for most general purpose applications. And for just \$26.95, you can afford to scatter a few wherever you might use a DMM!



Complete specifications on page 146.

Part No.	Product No.	1	10	25
220804CD	M320	\$26.95	\$25.65	\$24.35

Aerospace-Designed Wrench – Works in 1/2 the space!



Most open ended wrenches need a pivot angle of 60° to reinsert the wrench and perform the next movement. Alden wrenches need only 30°. Plus, the built-in ratchet eliminates the need to remove the wrench from the bolt or nut. Coupled with their small head sizes and ratcheting action you can loosen or tighten a bolt faster and in tighter spaces than any standard combo wrench. AldenWrench is made of stainless steel alloy widely used in aerospace and each is individually hand polished.

- Sizes: SAE 3/8-7/8, 1/2-9/16, 5/8-11/16
- Sizes: Metric 10-12, 13-14, 15-17
- Lifetime warranty

Part No.	Description	Price
223896CD	Open-end ratcheting 3 pc. wrench set (SAE)	\$34.95
223909CD	Open-end ratcheting 3 pc. wrench set (Metric)	34.95

Universal Programmer – Pocket Size, Battery Powered and Parallel Port Interface

The GALEP-4 is a pocket-sized device programmer with universal programming capability. A unique ASIC pin driver was designed specifically for this latest generation programmer, enabling the first true universal input/output capability. Along with basic functions such as read, program, compare, and erase, the software permits setting specially designated functions for any selected device.



GALEP-4

- Supports 1500+ device groups: 8-bit and 16-bit EPROM, EEPROM, FLASH EPROM, Serial EEPROMS, all Microcontrollers, GAL/PAL/CE without adaptors
- Support for ultra-low voltage devices down to 1.3 volts
- High speed data transfer: 27C256 read/verify = 2 seconds; program = 8 seconds
- Three separately adjustable voltages for all 40-pins
- Fully compatible with Windows® 95/98/ME/NT/2000/XP
- Integrated editor's many features allow user to edit device data, which can be loaded or saved in INTEL HEX, Motorola S, or binary format
- Operates on AC power adapter or 6 NiMH batteries (not included)
- Size: 4.5"L x 3.1"W x 1.3"H
- Weight: 2.0 lbs.

Includes: printer port data cable, AC power adapter, CD software

System requirements: PC with Pentium® CPU

Part No.	Description	1	5
226309CD	GALEP-4	\$369.95	\$351.49

30-Piece Bit Set with Drum Organizer

A 30-piece bit set supplied in a neat, compact storage drum organizer allows quick access, identification, and selection of the desired bit. All the bits are compatible with power tools, rechargeable drills, and multi-bit screwdriver handles.



Set includes:

- Nut bits: 7/16", 3/8", 11/32", 5/16", 9/32", 1/4", 3/16"
- Hex bits: 3/16", 1/8", 7/64", 5/64"
- Torx bits: T10, T15, T20, T25, T30
- Phillips bits: #0, #1, #2, #3
- Slotted bits: #3, #4, #5, #6, #7
- Pozi bits: #1, #2, #3
- 1 bit holder
- 2 screw aligners

Part No.	Description	1	5
227230CD	30-Piece bit with organizer	\$9.95	\$8.95

65-Watt Soldering Station With Micro Soldering Pencil

The micro soldering pencil has the shortest tip-to-grip distance on the market today, giving you excellent control by putting you closer to the work. The heating element is contained in the pencil rather than the tip so you do not throw away a good heater every time you wear out a tip.



- Fast heat-up and thermal recovery
- Tips are secured to the pencil by use of a threaded end, eliminating the use of a barrel nut
- Temperature is reduced to 300°F (150°C) when pencil is not used for 20 minutes. Unit is switched off after 60 minutes of inactivity
- ESD safe to protect sensitive components
- Voltage: 120V input; 24V output
- Temperature range: 150°F-850°F (66°C-454°C)
- Temperature accuracy: ±9°F (±5°C)
- Temperature stability: ±10°F (±6°C)

Includes: WSLPU power unit, WMP soldering pencil with NT1 tip, and WMPH iron stand

Part No.	Product No.	1	5
227408CD	WSL	\$255.95	\$237.95

Voice Direct II Stand-Alone Speech Recognition Kit

Bring life to consumer electronics, toys, motors, appliances, lights, and games through the power of VoiceActivation™ from Sensory. Voice Direct™ II is a speaker-dependent speech recognition module, allowing training of up to 15 words; capable of being organized into 1 to 3 command sets. Using sophisticated speech recognition technology, Voice Direct™ II maps spoken commands to system control functions via digital I/O ports. Each time one of the words is recognized, output pins on the module are toggled high for 1 second. With Continuous Listening Technology, it means no button press is required for activation. Up to 3 "gateway" words can be programmed, each allowing access to 5 commands. In addition, Sensory's latest Voice Direct™ II technology builds on the original Voice Direct™ by offering even higher accuracy, faster response times, and improved noise immunity.



Part No.	Description	1	10
225971CD	Speech recognition Kit	\$59.95	\$53.95

DIN Rail Mounting Accessories

Professionally mount your Mean Well enclosed power supplies (see pages 6-31) with these new DIN rail mounting kits.

222121CD: Vertical Bracket Mount

- For S-25, S-40, T-40 and SD-25 series power supplies

222130CD: Vertical Bracket Mount

- For S-60, S-100F, S-150, Sp-100, SP-200, SP-300, D-60, D-120, T-60, TP-100, TP-150, QP-100, QP-150, Q-60 and Q-120 series power supplies

222148CD: Vertical Bracket Mount

- For S-240, S-320, SP-75 and QP-200 power supplies

222156CD: Horizontal Plate Adapter

- For all case types and models

222164CD: DIN Rail Clip

- For S-25, SP-100, SP-150, SP-200, SP-75, TP-100, TP-150, QP-100, QP-150 and SD-25 series power supplies

222172CD: DIN Rail Clip

- For all models

222181CD: Short Mounting Bracket

- For S-320, SP-100, SP-150 SP-200, TP-100, TP-150, QP-100, QP-150, QP-200 and SP-300 series power supplies

222199CD: Long Bar Mounting Bracket

- For PSP300, SP-500 power supplies

Part No.	Product No.	Description	1	10	50	100
222121CD	DRL-01	DIN rail mounting bracket	\$1.79	\$1.59	\$1.45	\$1.29
222130CD	DRL-02	DIN rail mounting bracket	2.39	2.15	1.95	1.79
222148CD	DRL-03	DIN rail mounting bracket	3.19	2.89	2.59	2.39
222156CD	DRP-01	Horizontal plate adapter	3.85	3.45	3.15	2.79
222164CD	DRP-02	DIN rail clip	2.39	2.15	1.95	1.79
222172CD	DRP-03	DIN rail clip	1.99	1.79	1.59	1.49
222181CD	MHS-012	Short mounting bracket	.49	.45	.39	.35
222199CD	MHS-025	Long bar mounting bracket	3.19	2.89	2.59	2.35



222156CD



222172CD

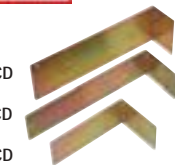

222121CD

222130CD

222148CD



222164CD

The Ultimate Laser Pointer with Dot, Underline, and Arrow Pointer



The most advanced pen-style laser ever designed. No need to buy more than one laser pointer to get your presentation across. With a simple twist of the head, you can transform the powerful 5mW red laser into an arrow, or a dot, or an underline pointer up to 500 yards away. Use the arrow for pointing out details of an image, a dot for general use, and the underline for highlighting important text for maximum impact. Made of brass, it comes with 2 AAA batteries for 3 hours of continuous use and a gift case.

- Range: 100 yards for arrow, 500 yards for dot, 15 yards for underline
- Color: matte black finish • 650nm red diode laser • Power: <5mW

Part No.	Description	1	5
223722CD	Laser pointer with dot, underline, and arrow pointer	\$69.95	\$65.95



Popular and Out-of-Production Electronic Products 24/7 Service, Expert Support, and Low-Price Guarantee

New! Name-Brand Connectors

Now you can get AMP, AMPHENOL and MOLEX connectors at Jameco's great prices! We've expanded our line of D-SUB, UHF, BNC and power connectors from these leading connector manufacturers. So whether you need data, RF or power connectors, be sure to thumb through pages 124-135.



Connectors on pages 124-135.

Name-Brand Power Supplies – New Lower Prices!

Look through pages 5-59 and see why Jameco should be your primary source for power products. We now offer you 29 pages of switching and linear power supplies including new low-leakage medical models. Plus, through improved buying power, we've been able to reduce the price of many name-brand products. You'll find

Artesyn Technologies, a top quality U.S. brand, and value-priced performance power supplies from Mean Well and other well-known manufacturers.



For Power Products see pages 5-59.



Semiconductors

Look no further than Jameco Electronics for thru-hole and Surface Mount Technologies at great prices. Our extensive network of product sources allows us to provide you with great values in discrete IC's; microprocessors; programmable, read-only and flash memory; linear devices; transistors; triacs, SCR's and much more.



See pages 68-85 for complete listing.

New Test Equipment

Whether you need a \$2,500 o'scope or a \$9.95 digital multimeter, you can find great new values at Jameco Electronics. We offer a complete line of bench-top power supplies, digital and analog test devices, meters and much more. And to help you make better choices, be sure to visit our handy DMM selector on page 142.



See pages 138-154 for Test Equipment.

Discrete Components

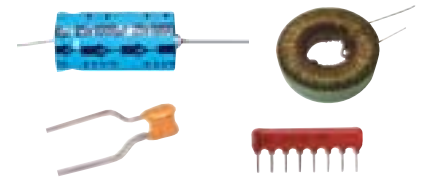

Keep your supply cabinets stocked and save money too! Jameco offers a complete line of widely-used discrete components for your convenience. So be sure to check out pages 86-92 and learn how you can save money on your discrete component purchases.

Complete selection on pages 86-92.

Find More Products @ www.Jameco.com



1355 Shoreway Road, Belmont, CA 94002-4100

Toll Free Ordering, Customer Service & Technical Support
1-800-831-4242

Domestic FAX: 1-800-237-6948 / International FAX: 1-650-592-2503
e-mail: info@Jameco.com

<http://www.Jameco.com>

PRESORTED STANDARD
AUTO CR
US POSTAGE PAID
JAMECO ELECTRONICS

Customer Number

VIP Number